

June 2026

# Bill's Truck Shop Limited

CHEV GMC  
1ST DESIGN  
**1947-1955**  
1ST DESIGN  
BUY TRADE  
SELL

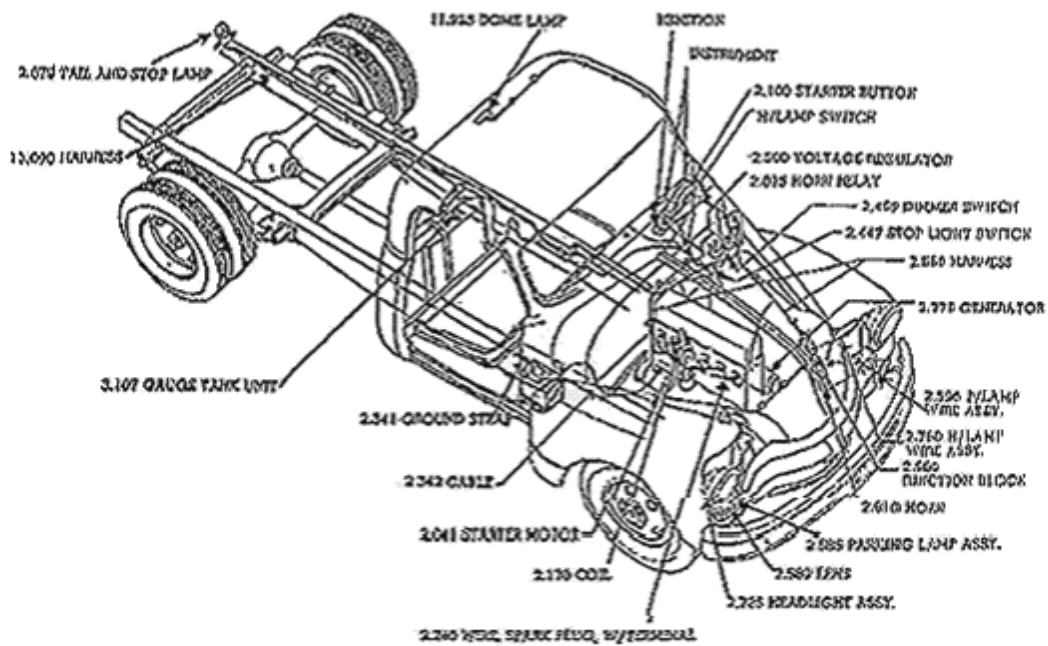

Phone: (905) 725-3460, (905) 725-2022  
(905) 404-2302

web: [billstruckshop.com](http://billstruckshop.com)

Email: [mike@billstruckshop.com](mailto:mike@billstruckshop.com), [rob@billstruckshop.com](mailto:rob@billstruckshop.com),  
[aaron@billstruckshop.com](mailto:aaron@billstruckshop.com)

## GENERAL INFORMATION

**Ordering Information:** Please make sure you are ordering the correct parts. Verify page numbers and part numbers upon ordering. On larger orders please fax (905) 404-2302, email at / [rob@billstruckshop.com](mailto:rob@billstruckshop.com) / [aaron@billstruckshop.com](mailto:aaron@billstruckshop.com) or call for more information.

**Payment:** We accept VISA, MasterCard, Money Orders, E-Transfers, Personal and Company cheques. Payment plans also available on large restoration. Applicable taxes apply to all sales.

**Shipping:** Ship by your choice of Canpar, UPS, FedEx, Canada Post, or truck carrier on some large items. Most orders can be shipped same day for next business day delivery. Actual shipping charges will be applied. Also a \$10.00 COD surcharge applies.

**Pricing:** Prices are in Canadian currency. Due to constant fluctuation between the Canadian and U.S. dollar –refer to the prices in the catalogues as a **GUIDE ONLY!** Bill's Truck Shop Limited Ltd., reserves the right to make appropriate changes as necessary. We try to keep prices low by keeping a large inventory on hand at all times. WE never buy parts with YOUR money to sell to YOU so we never pre-charge you for normal stocking items that are out of stock.

**Returns and Guarantees:** If fault is found in the parts or workmanship of item purchased, full money back guarantee or exchange for new item. If fault occurs from installation or misuse, no return will be given. No refunds will be given on electrical components or literature. Call with any questions.

**Back Orders:** No shipping charges will be applied to regular stocked items, unless a manufacturer's back order applies. All back orders cancelled after 60 days.

**Discounts:** Business's may apply for discounts after providing valid business info. Regular customer discounts can be applied depending on volume purchases / monthly specials and payment type. (E.g.: 3% discount on cash sales - on applicable items only) Check our website for monthly specials.

**Parts:** There is an ever increasing supply of reproduction parts; they are not always listed in the catalogues. New items can be viewed on our website, [www.billstruckshop.com](http://www.billstruckshop.com) or call for info.

**Used Parts:** Unlike many other parts suppliers we stock or locate many parts that are not reproduced. We import parts from (California) and bring back trucks, beds, cabs etc. Bill's Truck Shop Limited has made a commitment to supply many new and used parts for your restoration and as a result we are the largest truck part supplier in Canada. NO discounts on used parts. We also will take your used parts in on trade.

### **Hours of Operation:**

Monday to Friday 8:00am to 5:00pm EST

Saturday 8:00am to 1:00pm – Confirm by appointment

Sunday and holidays –Closed

**NOTE: IF DRIVING LONG DISTANCE TO VIEW OUR INVENTORY, PLEASE CALL AHEAD**

# Weather-stripping-Hardware

Group 1



1-201-S



1-0150-C

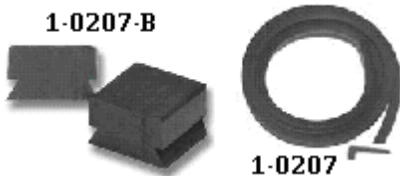

1-0207



1-204-2

**Windshield -Deluxe will accept stainless steel trim**

		<u>Year</u>	<u>New</u>
1-201-S	standard-does not accept trim	47-53	\$114.95
1-201-D	deluxe accepts trim	47-53	\$114.95
1-201-54S	standard- does not accept trim	54-55	\$89.95
1-201-54D	deluxe accepts trim	54-55	\$89.95

**Corner Glass Weather-strip (pair)**

1-0150-B	w/ black lock strip	47-55	\$49.95
1-0150-C	w/ chrome lock strip	47-55	\$59.95

**Rear & Corner Glass Weather-strip**

1-0150-B	w/ black lock strip	47-66	\$49.95
1-0150-C	w/ chrome lock strip	47-66	\$59.95

**Lock Strip per ft 7/16 W x 7/32W**

1-0500	<b>chrome replacement-sold per ft</b>	47-66	\$3.00
1-0748	<b>black replacement-sold per ft</b>	47-66	\$1.50

**Panel & Suburban Rear Glass Weather-strip**

1-0204	seal for rear glass in doors and upper hatch - universal type----- cut 1/2 for rear door glass	47-59	\$59.95
1-0204-OE	vulcanized 1 pc OE style for rear barn door glass ----- each	47-54	\$109.95

**Rear Valance Seal-panel & suburban**

1-0207	between rear bumper and rear valance	47-59	\$26.95
--------	--------------------------------------	-------	---------

**Suburban Side Window Weather-strip Kit**

1-204-2	kit does 4 sliding side windows	47-55	\$399.95
---------	---------------------------------	-------	----------

*Bill's Truck Shop*

Phone (905) 725-3460 / (905) 725-2022 / (905) 404-2302

# Weather-stripping-Hardware

Group 1

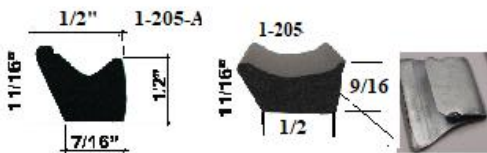
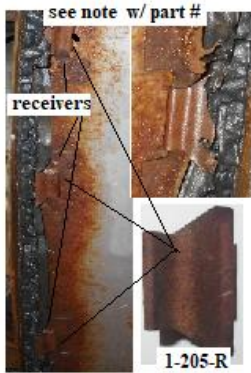

**Door Rubber Seals** Glues to edge of door-view pictures provided-we have found over the years that 2 diff thickness door seal were used-order as required

1-205	11/16 tall x 1/2 wide base	Precision brand	47-55	\$35.00
1-205-A	11/16 tall x 7/16 base	-used on Canadian built trucks w/ seal retainer -off shore brand		
(1-205-R)	receivers at door hinge end of door	(see below)	47-55	\$9.45
1-0205-R	panel & suburb rear cargo dr seal	- pr	36-66	\$39.95

**Lower Door Seal Retainer**

1-205-1	steel	each	47-55	\$14.95
1-205-1SS	stainless steel	each	47-55	\$22.95

**Retainer Screw Kit -2drs**

1-205-SK		16 pcs	47-55	\$5.95
1-205-SKSS	stainless steel	16 pcs	47-55	\$6.95

**Door Seal Retainer @ roll @ ft & rear of door**

1-205-SR	-prevents seal from coming of roll	pr	47-55	\$6.25
1-205-R	47-53 Retainer-door-ft inner	each	48-55	\$9.45

Late 1948 to 55 1<sup>st</sup> had metal receivers spot welded on the door shell ( @ front between door hinges ) for the clips to slide into -this helped prevent door seal from coming off --may require slotting seal for clip when using NEW seals as they are thicker then OE-this part is on Canadian built trucks only

**Door Bumper 2 doors**

1-206-47		4pcs	47-51	\$4.95
1-206-52		2pcs	52-55	\$4.25

*Bill's Truck Shop*

Phone (905) 725-3460 / (905) 725-2022 / (905) 404-2302

# Weather-stripping-Hardware

Group 1



## Super Weather-strip Adhesive-black

1-0WA \$21.95

## Glass Setting Tape - for door and vent glass

1-0GST 1/12 W x 0.062 thick per foot \$3.95  
 1-0GST-1 1/12 W x 0.047 thick per foot \$2.95

## Cab Wind lace Rubber- on cab door opening

1947- Early '49 held w/ screw-on retaining strip.  
 Late 49-54 w/ weld-on steel track.----colours are special order—Can use to 47-49 when updating retainers

1-211-47B black pair 47-49 \$39.95  
 1-211-B black pair 49-55 \$99.95  
 1-211-GT grey/tan pair 49-55 \$124.95  
 1-211-DB dark blue w/ dlx cab pair 54-55 Inquire  
 1-211-DG dark green w/ dlx cab pair 54-55 Inquire

**Wind lace Retainer on cab-**47-50 retainer is held to cab w/ screws and 50-55 is welded to cab w/ seal inserted in groove NOTE the 50-55 style retainers can be installed on 47-50 w/ 50-55 style windlace

Below can be used 47-49 w/ correct windlace

1-211-50-LK 3 pc kit for left side Late49-55 \$129.95  
 1-211-50-RK 3 pc kit for right side Late 49-55 \$129.95

To replace partial pc on ft or rear retainer use upper retainer

## Lower Cab Wind lace Rubber – pair

Edge of floor at door opening ----colours are special order

1-212-47B black 47-49 \$39.95  
 1-212-B black 49-55 \$42.95  
 1-212-GT grey/tan 50-55 \$34.95  
 1-212-DB dark blue 50-55 \$34.95  
 1-212-DG dark green 50-55 \$34.95

1947 to 1950 doors do not have vent windows

1951 First year for vent window and last for turn

Down door handles

Inquire about parts not listed

*Bill's Truck Shop*

Phone (905) 725-3460 / (905) 725-2022 / (905) 404-2302

# Weather-stripping -Hardware

# Group 2

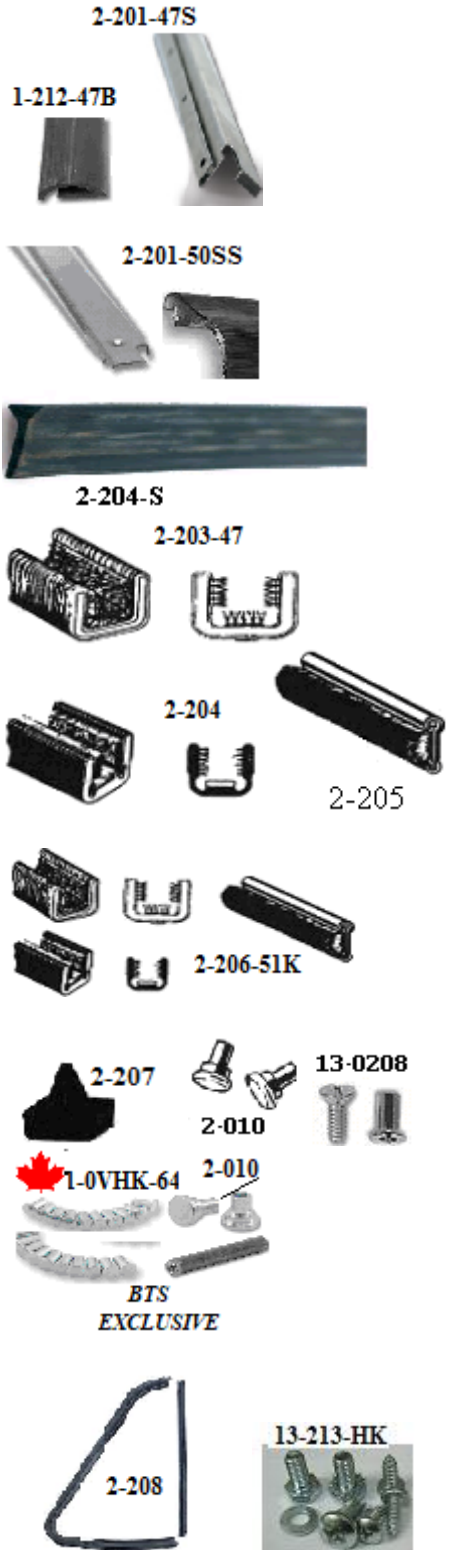

			<u>Year</u>	<u>New</u>
<b>Lower Windlace Retainer -floor edge @ door.(each)</b>				
2-201-47S	steel		47-49	\$25.95
2-201-47SS	stainless steel		47-49	\$39.95
2-201-50S	steel		49/50-55	\$22.95
2-201-50SS	stainless steel		49/50-55	\$34.95
<b>Lower Wind lace Retainer Screws</b>				
2-201-2SS	(16) - stainless steel		47-49	\$5.95
2-201-3SS	(8) - stainless steel		50-55	\$2.95
<b>Door Glass Channel Runs -felt lined steel track for door glass</b>				
2-203-47	w/o vent windows	pair	47-50	\$189.95
2-203-50	w/ vent window	pair	51-55	\$84.95
<b>Division Bar Relining Channels-felt lined</b>				
2-204		pair	51-55	\$69.95
<b>Outer Window Rubber Seal</b>				
2-204-S	fits on outer horizontal track inside door	pair	47-55	\$13.95
<b>Door Window Inner &amp;Outer Seals With Clips</b>				
2-205-47		4 pcs	47-50	\$79.95
2-205-51		4 pcs	51-55	\$69.95
<b>Door Glass Felt Kit—felt lined steel core w/ in-outer scraper</b>				
2-206-47K	includes 203-47/205-47	6pcs	47-50	\$249.95
2-206-51K	includes 203-50/ 204/ 205-51	8pcs	51-55	\$189.95
<b>Window Stop Bumper</b>				
2-207		pair	47-55	\$4.95
<b>Vent Window Weather-strip</b>				
2-208	original design –	pair	51-55	\$84.95
<b>Vent Assembly Pivot Rivets</b>				
2-010			51-55	
2-010	pivots glass frame on assembly-	pair	64-87	\$6.25
<b>Vent Assembly Kit-includes assembly , pivot rivets &amp; tool</b>				
1-0VHK-64	1951-55 and 64-87		51-87	\$16.95
<b>Vent Window install hardware kit</b>				
13-213-HK	9 pcs	per side	51-55	\$5.95
<b>Door Glass Frame Screws (barrel nut &amp; screw)</b>				
13-0208	47-50 requires 4 per window	each	47-61	\$1.50

*Bill's Truck Shop*

Phone (905) 725-3460 / (905) 725-2022 / (905) 404-2302

# Vent Window - Cowl-Seals

Due to the fluctuation of the Canadian and American dollars call for current prices

Group 2



## Door Hinge Seals

		<u>Year</u>	<u>New</u>
3-020-S	panel/suburban w/ barn doors-set of 4	36-59	\$36.95

## Top Cowl Vent assembly

2-215		47-53	\$249.95
2-215-54		54-55	

## Top Cowl Vent Hdw install kit

2-215-HK	18 pcs	47-53	\$8.95
2-215-4HK	20 pcs	54-55	\$8.95

## Top Cowl Vent Gasket

2-215-1	sponge	47-53	\$9.95
2-215-2	sponge	54-55	\$9.95

## Top Cowl Vent Drain Hose

2-215-3	install on angle not to drain on engine	47-55	\$8.95
---------	-----------------------------------------	-------	--------

## Cowl Vent Knob-top vent and 47-50 side vent

2-215-M	Maroon	47-53	\$13.95
2-215-B	Black	54-55	\$12.95

## Side Cowl Vent Gasket

3-201-S	sponge	47-50	\$6.95
---------	--------	-------	--------

## Side Cowl Handle Cover w/gasket

3-201-C	w/machine screws like OE	47-50	\$21.95
---------	--------------------------	-------	---------

## Side Cowl Handle Gasket

3-201-G		47-50	\$4.25
---------	--	-------	--------

*Bill's Truck Shop*

Phone (905) 725-3460 / (905) 725-2022 / Fax (905) 404-2302

# Seals/Hardware-Fender-Hood-Doors

Group 3

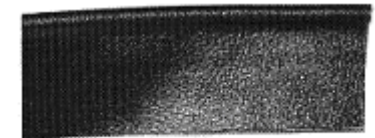

			<u>Year</u>	<u>New</u>
<b>Inner/Outer Fender Seal Kit</b>				
3-204	w/instructions		47-55	\$34.95
<b>Outer Fender Weld Beading @ Cowl</b>				
3-205		6ft	47-55	\$7.95
<b>Firewall to Fender Panels</b>				
Top of inner fender to firewall				
3-206	1/2-3/4 and 1 ton	pair w/ screws	47-55	\$16.95
3-206-1	1 1/2 ton up	pair w/ screws	47-55	\$16.95
<b>Front Fender Braces-fender to cab approx. 10 1/2 long 1/2, 3/4 &amp; 1 ton</b>				
3-21FS	steel/ front	pair	47-55	\$36.95
3-21FSS	stainless steel / front	pair w/ hdw	47-55	\$42.95
<b>Rear Fender Braces 11" long w/ short step</b>				
3-21RS	steel / rear- short step	pair	47-55	\$39.95
3-21RS-P	steel-panel/surban	pair	47-55	\$36.95

*Bill's Truck Shop*

Phone (905) 725-3460 / (905) 725-2022 / (905) 404-2302

# Hood Parts

Due to the fluctuation of the Canadian and American dollars call for current prices

Group 3

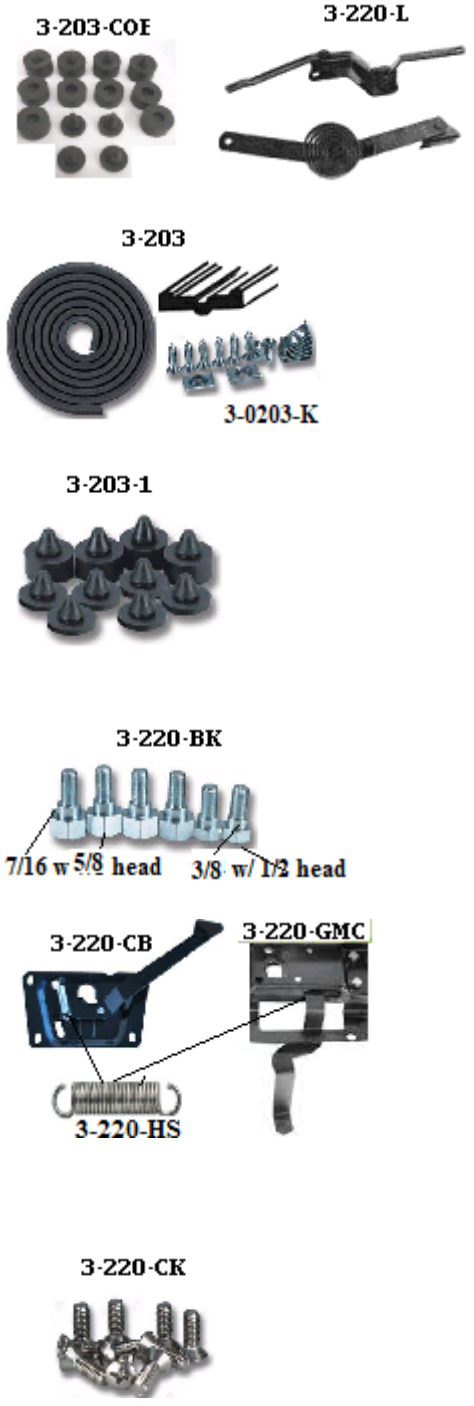

		<u>Year</u>	<u>New</u>
<b>Hood to Cowl Seal with hardware</b>			
3-203	includes retainers & screws	47-55	\$19.95
<b>Cowl Seal Hardware kit (included w/ seal)</b>			
3-0203-K	8 retainers w/ screws	36-55	\$ 5.95
<b>Hood Bumper Set</b>			
3-203-1	may require urethane to secure 10 pcs- ----GMC hood side only	47-55	\$10.95
3-203-COE		47-55	\$ 26.95
<b>Hood Hinge w/ spring</b>			
3-220-L	2 pc left	47-55	\$89.95
3-220-R	2 pc right	47-55	\$89.95
<b>Hood Hinge Bolt Kit</b>			
3-220-BK 4 x 7/16 collar and 2 x 3/8 collar Some early 1947 & early 48 w/ original hinges --- bolt size-maybe all 7/16 collar-- same also applies to COE trucks-all replacement hinges take the later bolt kit			
3-220-BK-47	6 x 7/16 collar bolts w/ OE	47 early	\$21.95
	hood hinges	48	\$21.95
3-220-7/16	hood hinge bolt	each 47-55	\$3.00
3-220-3/8	hood hinge bolt	each 47-55	\$3.00
<b>Hood Release Assembly</b>			
3-220-CB	black - Chev	47-55	\$104.95
3-220-CC	chrome - Chev	47-55	\$119.95
<b>Hood Release Handle Return Spring</b>			
3-220-HS	ecures handle in lock position Chev & GMC	47-55	\$3.25

*Bill's Truck Shop*

Phone (905) 725-3460 / (905) 725-2022 / (905) 404-2302

# Hood Parts

Due to the fluctuation of the Canadian and American dollars call for current prices

Group 3

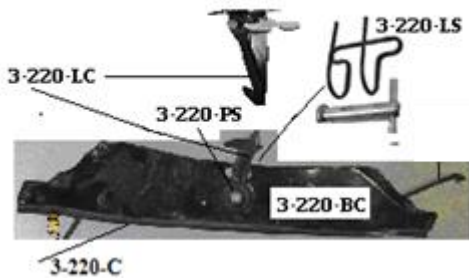
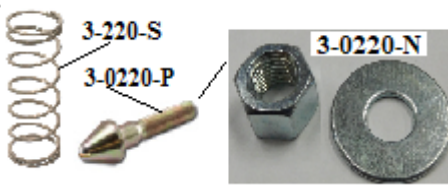

3-220-HK



### Safety Catch Assembly – second safety catch

3-220-LC bolts on front of hood brace Chevy & GMC 47-55 \$109.95

### Safety Catch Handle Spring w/ clevis pin –NEW

3-220-LS on secondary hood safety catch 47-55 \$19.95

### Hood Lock Pin and spring

3-0220-P pin 47-55/67-74 \$12.95

3-220-S spring 47-55 \$6.95

### Hood Lock Pin- lock nut & washer

3-0220-N \$1.50

### Hood latch support bolt kit @ front of hood

3-220-CK stainless steel countersunk bolts to secure brace to hood halves and rods washers & nuts included -18pcs Chev 47-55 \$9.95

3-220-GK stainless steel countersunk bolts to secure brace to hood halves GMC 6 screws 47-55 \$5.95

### Hood support rods w/ hardware

3-220-B Chev hood only pr w/hdw 47-55 \$79.95

### Hood support rods hdw kit—both side

3-220-HK 8 pcs 47-55 \$5.95

### Hood Support @ rear of hood

3-220-B - pair 47-55 \$79.95

*Bill's Truck Shop*

Phone (905) 725-3460 / (905) 725-2022 / (905) 404-2302

# Dash Gauges

Due to the fluctuation of the Canadian and American dollars call for current prices

Group 4

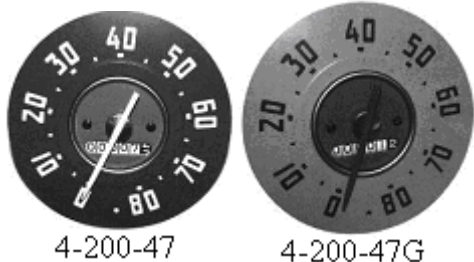

47-49 Chev & 47-51 GMC high beam indicator is @ bottom and 50-53 Chev & 52-53 GMC is @ the top  
**Speedometer Gauge -please check that the needle clears the glass on install**

			<u>Year</u>	<u>New</u>
4-200-47	Chev	80 MPH w / white needle	47-49	\$279.95
4-200-47RN	Chev	80 MPH w/ red needle	47-48	\$259.95
4-200-47G	GMC	80 MPH w/ red needle-tan background	47-51	\$259.95
			50-53-C	
4-200-50	Chev/GMC	90 MPH w / white needle/grey background	52-53-G	\$259.95
4-200-54	Chev		54-55	\$259.95

## Speedo Cluster Assembly

Complete new gauge cluster assemblies with either 6 or 12 volt and 6 or 8 cyl application-confirm needle & background colour---**EARLY 1947 dash cluster mount ears are 4 3/4 dist apart-later are 6"**

4-247-SC	Chev only	0-80 mph w/ white needle & letters high beam indicator @ bottom grey/brown background	47-48	\$429.95
4-247-SC-R	Chev only	0-80 mph w/ red needle w/ white letters high beam indicator @ bottom grey/brown background	47-48	\$429.95
4-247-SCG	GMC	0-80 mph w/ red needle-high beam indicator @ bottom cream back ground	48-51	\$429.95
			50-53-Chev	
4-250-SC	Chev & GMC	0-90 mph w/ white needle-gray/brown background - high beam indicator is @ top Oil gauge square nut must be secured when installing oil line-failure do to so will damage gauge-----NO WARRANTY	52-53-GMC	\$439.95
4-254-SC	54-55 Chev & 54 GMC	0-90 mph	54-55	\$424.95

## Gauge Decal Kit Die-cut nylar decals in correct size,

4-204	80 MPH Chev w/ dark face-white numbers-high beam indicator @ bottom		47-49	\$22.95
4-204-1	80 MPH GMC w/ cream face w/ dark numbers		47-51	\$22.95
4-204-2	90 MPH Chev-GMC w/ dark face-white numbers-high beam indicator @ top		50-53	\$22.95
4-204-3	Chev black /light green		54-55	\$15.95
4-204-4	GMC w/ round cluster		55-55	\$31.00
4-0304-G	late 1st series 55 w/ square cluster		55-59	\$23.95

**Bill's Truck Shop**

Phone (905) 725-3460 / (905) 725-2022 / (905) 404-2302

# Dash Gauges

Due to the fluctuation of the Canadian and American dollars call for current prices

Group 4

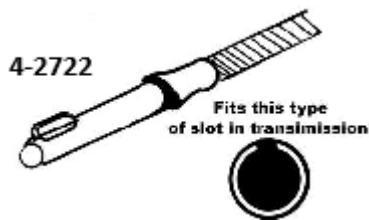
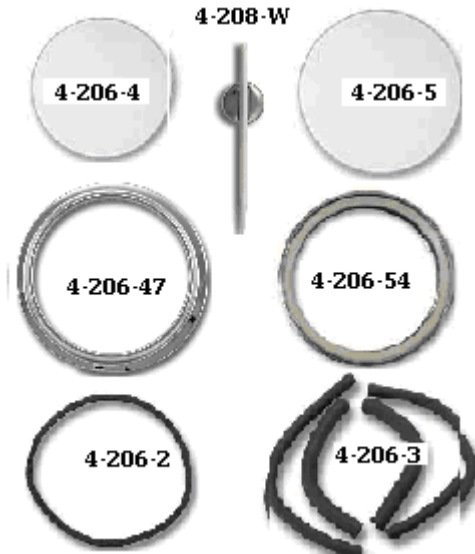

## Speedo and Gauge Bezel

Part Number	Description	Unit	Year	New
4-206-47	chrome	each	47-53	\$26.95
4-206-54	54-55 Chev&54 GMC stainless steel	each	54-55	\$39.95

## Speedo and Gauge Bezel Gaskets at bezel glass

4-206-2			47-53	\$5.95
4-206-3			54-55	\$3.50

## Speedo and Gauge Glass

4-206-4		each	47-53	\$14.95
4-206-5		each	54-55	\$7.95

## Speedometer Needle

4-208-R	red/orange	47-48-Chev/47-51 GMC	47-53	\$12.95
4-208-W	white	49-53 Chev/52-53 GMC	49-53	\$11.95

## Speedometer Cable

4-0SCP	70 " w/ plastic housing	47-72	\$24.29
4-0SCS	w/ steel casing 70 "	47-72	\$26.95
4-0SCP-0	w/ plastic casing 75"	47-72	\$39.95
4-0SCP-1	w/plastic casing 85"	47-72	\$59.95
4-0SCP-2	w/plastic casing 100"	47-72	\$59.95

4-2722	metal cable w/ key drive	38-55	\$112.95
--------	--------------------------	-------	----------

## Speedometer Cable Grommet

4-0208-5	cut on angle to center to install over cable	47-55 60-72	\$2.95
----------	----------------------------------------------	----------------	--------

*Bill's Truck Shop*

Phone (905) 725-3460 / (905) 725-2022 / (905) 404-2302



4-210-50-12



4-210-VR



4-210-VRA



4-250-T8

4-247-T6G



4-0250-B



## CONFIRM BACKGROUND & NEEDLE COLOUR

There have been some issues w/ the repro gauges as they have the pin style sweep needle instead of the inner sweep needle ( see picture) and making contact w/ the upper gauge inner bezel-this requires removing some of this bezel for the needle to clear

Year      New

**Fuel Gauge** –battery “in” post on the “E” side of the gauge  
OE “F” fuel sender/tank side w/ 0 - 30 ohms fuel sender// **dash assembly must be grounded before testing**

4-210-47-6	<b>Chev</b>	w/ red needle-6volt	47-49	\$119.95
4-210-47-12	<b>Chev</b>	w/ red needle-12volt	47-49	\$119.95
4-210-50-6	<b>Chev</b>	w/ white needle-6volt	50-53	\$119.95
4-210-50-12	<b>Chev</b>	w/ white needle-12volt	50-53	\$119.95
4-210-54-6	<b>Chev</b>	w/ 6 volt	54-55	\$119.95
4-210-54-12	<b>Chev</b>	w/ 12 volt	54-55	\$119.95
4-210-55	1 <sup>st</sup> GMC			
4-210-47-G6	<b>GMC</b>	w/ red needle-6 volt	47-51	\$119.95
4-210-47-G12	<b>GMC</b>	w/ red needle-12 volt	47-51	\$119.95
4-210-50-6	<b>GMC</b>	w/ white needle-6volt	52-53	\$119.95
4-210-50-12	<b>GMC</b>	w/ white needle-12volt	52-53	\$119.95

## Fuel Gauge Volt Reducer

4-210-VR      electronic reducer for gauges from 12 to 6 volts      47-55      \$28.95

## Voltage Reducer when changing to 12 volts

4-210-VRA      universal style      47-55      \$6.95

## Temperature Gauge w/tubing V8 tube is 60 in long

4-247-T6	<b>Chev</b>	w/ 6 cyl-red needle-45”tube 100-212 deg-	47-49	\$122.95
4-247-T8	<b>Chev</b>	-w/ 8cyl-w/red needle-60” tube 100-220 deg -	47-49	\$122.95
4-250-T6	<b>Chev</b>	w/ 6cyl-w/white needle-45”tube 100-212 deg	50-53	\$122.95
4-250-T8	<b>Chev</b>	w/ 8cyl-w/white needle-60”tube 100-220 deg	50-53	\$122.95
4-254-T6	<b>Chev</b>	for 6 cyl engine-45 “ tube	54-55	\$122.95
4-254-T8	<b>Chev</b>	for 8 cyl engine-60 “ tube	54-55	\$122.95
4-255-T6	1 <sup>st</sup> GMC			55-55
4-247-T6G	<b>GMC</b>	w/ 6 cyl-red needle 45”tube 100-220 deg	47-51	\$122.95
4-247-T&G	<b>GMC</b>	w/ 8 cyl-red needle 60”tube - 100-220 deg	47-51	\$122.95
4-250-T6	<b>GMC</b>	w/ 6cyl-w/white needle-45”tube 100-212 deg	52-53	\$122.95
4-250-T8	<b>GMC</b>	w/ 8cyl-w/white needle-60”tube 100-220 deg	52-53	\$122.95

## Temp Gauge Bushing

4-0250-B      brass bushing to adapt temp line to newer cyl head      \$12.95

**NO WARRANTY ON GAUGES IF INSTALLED INCORRECTLY**

*Bill's Truck Shop*

Phone (905) 725-3460 / (905) 725-2022 / (905) 404-2302

# Dash Gauges

Due to the fluctuation of the Canadian and American dollars call for current prices

Group 4

4-250-060



4-247-0



5-0682



5-0LK

41-0249-A



4-250-V



4-247-V



4-0200-K



4-253-SK



## Oil Gauge- you must secure the gauge nut when tightening oil line to gauge-no warranty on broken gauges

4-247-O	<b>Chev</b> -red needle -30 lbs w/ 6 cyl	47-49	\$99.95
4-247-O60	<b>Chev</b> -red needle-60 lbs w / 8 cyl	47-49	\$119.95
4-250-O	<b>Chev</b> -white needle 0- 30lbs w/ 6 cyl	50-53	\$99.95
4-250-O60	<b>Chev</b> -white needle 0- 60lbs w/ 8 cyl	50-53	\$109.95
4-254-O	<b>Chev</b> 0 - 60 lbs	54-55	\$109.95
4-247-OG	<b>GMC</b> w/ red needle -60 lbs	47-51	\$99.95
4-250-O	<b>GMC</b> -white needle 0 -30lbs w/ 6 cyl	52-53	\$99.95
4-250-O60	<b>GMrft5C</b> -white needle 0 -60 lbs w / 8cyl	52-53	\$99.95

## Oil Line kit

5-0LK	5 ft copper tubing w/ correct fittings	47-55	\$34.95
-------	----------------------------------------	-------	---------

## Oil Line Block kit - 3 pc set

41-0249-A	2 outlet plug for oil gauge and filter line-screws in block	47-62	\$19.95
41-0249-1	1/8 pilot nut		\$2.95
41-0249-2	1/8 tube OD x 1/8 male pipe-gauge only		\$5.95
41-0249-3	1/8 NPT 3 outlet female		\$7.95
41-0249-4	1/ 8 x 1" connector tube		\$2.35
5-0682	V8 block fitting w/ comp w/ comp fitting		\$4.45

## Voltage / Amp- Battery Gauge 6 and 12 volts

4-247-V	<b>Chev</b> w/ red needle	47-49	\$121.95
4-250-V	<b>Chev</b> w/ white needle	50-53	\$119.95
4-254-V	<b>Chev</b> w/ white needle	54-55	\$109.95
4-255-V	<b>1<sup>st</sup> GMC</b>	55-55	
4-247-VG	<b>GMC</b> w/ red needle	47-51	\$76.95
4-250-V	<b>GMC</b> w/ white needle	52-53	\$119.95

NOTE-battery wire secures to pin on "D" side of gauge

## Dash Gauge Insulator/warning Label kit

4-0200-K		47-59	\$7.95
----------	--	-------	--------

## Dash Cluster hdw kit-secures cluster to dash studs

4-253-SK	8 nuts w/ washers	47-55	\$2.55
----------	-------------------	-------	--------

*Bill's Truck Shop*

Phone (905) 725-3460 / (905) 725-2022 / (905) 404-2302

# Dash Gauges Clusters

Due to the fluctuation of the Canadian and American dollars call for current prices

Group 4



4-247-SCG



4-250-SC



4-254-C



4-250-6C12



4-247-6G6



4-254-6C12

late 54 to 55 1st GMC



## Speedo Cluster Assembly-

4-247-SC	<b>Chev only</b> 0-80 mph w/ white needle-high beam indicator @ bottom grey/brown background	48-49	\$429.95
4-247-SCG	<b>GMC</b> 0-80 mph w/ red needle-high beam indicator @ bottom cream back ground	48-51	\$429.95
4-250-SC	<b>Chev &amp; GMC</b> 0-90 mph w/ white needle-gray/brown background – high beam indicator is @ top	50-53-Chev 52-53-GMC	\$439.95
Oil gauge square nut must be secured when installing oil line-failure do to so will damage gauge-----NO WARRANTY			
4-254-SC	<b>54-55 Chev &amp; 54 GMC</b> 0 -90 mph	54-55	\$424.95

## Gauge Cluster Assembly 47-49 Chev w / red needle grey/brown background

4-247-6C6	6cyl, 6 volt.0-30lb oil, 100-212 temp	48-49	\$649.95
4-247-8C12	8cyl, 12 volt.0-60lb oil, 100-212 temp	48-49	\$699.95
4-248-6C12	6cyl, 12 volt.0-30lb oil, 100-212 temp	48-49	\$599.95
4-249-6C12	6cyl, 12 volt.0-30lb oil, 100-220 temp	48-49	\$599.95
GMC red needle w/ cream back ground			
4-247-6G6	GMC 6cyl,6 volt,0-60 lbs oil,100-220 temp	48-51	\$699.95
4-247-6G12	GMC 6cyl,12volt.0-60lbs oil,100-220 temp	48-51	\$699.95
4-247-8G12	GMC 8cyl,12 volt,0-60 lbs oil,100-220 temp	48-51	\$699.95

## Gauge Cluster Assembly 50-53 Chev & 52-53 GMC w/ white needle-gray-brown background

4-250-6C6	6cyl, 6 volt.0-30lb oil, 100-212 temp	50-53C 52-53G	\$649.95
4-250-6C6-1	6cyl, 6 volt.0-30lb oil, 100-220 temp	50-53C 52-53G	\$649.95
4-250-6C12	6cyl,12 volt.0-30lb oil, 100-220 temp	50-53C 52-53G	\$649.95
4-250-6C12-1	6cyl, 12 volt.0-30lb oil, 100-212 temp	50-53C 52-53G	\$649.95
4-250-8C12	8cyl, 12 volt.0-60lb oil, 100-220 temp	50-53C 52-53G	\$649.95
4-250-8C12-A	8cyl, 12 volt.0-60lb oil, 100-212 temp	50-53C 52-53G	\$649.95

## Gauge Cluster Assembly 54-55 Chev & 54 GMC

4-254-6C6	6 cyl , 6 volt	54-55	\$649.95
4-254-6C12	6 cyl , 12 volt	54-55	\$649.95
4-254-8C12	8 cyl , 12 volt	54-55	\$649.95

*Bill's Truck Shop*

Phone (905) 725-3460 / (905) 725-2022 / (905) 404-2302

# Dome Lamp

Due to the fluctuation of the Canadian and American dollars call for current prices

Group 4



## Dome Lamp Assembly w / hdw

4-216-P				
4-216-C				

## Dome Lamp Bulb

16-205-DS6				
16-0205-12				

## Dome Lamp Lens Gasket

4-216-G				

## Dome Lamp Screw kit

4-216-S				

*Bill's Truck Shop*

Phone (905) 725-3460 / (905) 725-2022 / (905) 404-2302

# Dash Trim

Due to the fluctuation of the Canadian and American dollars call for current prices

# Group 4

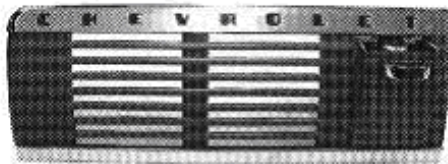

4-220-C



4-220-G



4-223-G



4-221-C



4-221-G



4-222



GMC



CHEV



4-0RIV

## Center Dash Speaker Grill w/Ash Tray

4-220-C stainless steel w/painted details includes up & low mld and ashtray w/chrome knob-*Chev*

Year

New

47-53

\$199.95

4-220-G stainless steel w/painted details includes up & low mld and ashtray w/chrome knob-*GMC*

47-53

\$199.95

## Dash Trim –upper mld w/ logo

4-221-G GENERAL MOTORS TRUCK (GMC)

47-53

\$84.95

## Dash Trim – lower mld

4-222 Chev & GMC

47-53

\$66.95

## Dash Trim Decal set

4-223-CB black vinyl /Chev truck **CHEVROLET**

47-53

\$5.95

4-223-CW white vinyl /Chev truck **CHEVROLET**

47-53

\$5.95

4-223-CR red vinyl /Chevy truck **CHEVROLET**

47-53

\$5.95

4-223-G black vinyl/GMC truck

47-53

\$5.95

## GENERAL MOTORS TRUCK

## I.D. PLATES

-Exact reproduction to replace damaged plates

4-247-C 81.5 HP @ 3100RPM Chev 4600lbs

47-49

\$34.95

4-247-G GMC open GVW

47-52

\$34.95

4-250-C 85HP @ 3300 RPM Chev 4600 lbs

50-50

\$22.95

4-251-C 85HP @ 3300 RPM Chev 4800lbs

51-52

\$36.95

4-253-C 85HP @ 3300 RPM Chev 4800 lbs

53-53

\$22.95

Note-47-52 plates were secured w / 2 x clutch drive screws

4-253-G GMC open GVW

53-54

\$24.95

4-254-C 105HP @ 3600 RPM Chev

54-55

\$34.95

## RIVETS-@ I.D. Plate-original plug style

4-0RIV pair of original style metal plugs

47-59

\$7.95

## Bill's Truck Shop

Phone (905) 725-3460 / (905) 725-2022 / (905) 404-2302

# Column-Dash

Due to the fluctuation of the Canadian and American dollars call for current prices

Group 5



		<u>Year</u>	<u>New</u>
<b>Steering Wheel—all used wheels w/ have some cracks</b>			
5-200-47	black	47-53	\$444.95
5-0200-54	black	54-56	\$449.95
<b>Horn Cap – Chevrolet</b>			
5-201-47C	Chev chrome w/ painted details	47-53	\$79.95
5-201-54C	Chev chrome w/ painted details	54-55	\$89.95
<b>Horn Contact &amp; Cap Retainer</b>			
5-201-2		47-53	\$40.95
5-0301-3		54-59	\$41.95
<b>Horn Contact Pin Spring &amp; Bushing</b>			
5-0201-4	12 volt system	47-66	\$12.95
5-0201-5	6 volt system w/ heavier internal cable	47-55	\$15.95
<b>Steering Wheel Retaining Nut w/ washer</b>			
5-0230-N		47-72	\$1.95
<b>Spring-Upper Column Bearing</b>			
5-0201-S		47-59	\$8.95
<b>Upper Column Bearing (with horn wire)</b>			
18-0311		47-59	\$94.95
<b>Spinner- Steering wheel (Brodie )</b>			
44-070BT	w/ Chev logo		\$29.95
<b>Wiper Knob-will not fit new style electric switch</b>			
5-204-47C	chrome	47-53	\$12.95
5-204-47M	maroon	47-53	\$9.95
5-204-54C	Chev black	54-55	\$11.95
5-204-54G	GMC grey	54-55	\$7.95
<b>Turn signal Lever with Knob</b>			
5-305-1		54-59	\$21.95
<b>Cable Lock Stop</b>			
5-0209			\$3.45

*Bill's Truck Shop*

Phone (905) 725-3460 / (905) 725-2022 / (905) 404-2302

# Column-Dash

Due to the fluctuation of the Canadian and American dollars call for current prices

# Group 5



		<u>Year</u>	<u>New</u>	<u>Used</u>
<b>Choke Cable w/ Knob</b>				
5-207-8	stainless steel & maroon	47-53	\$32.95	
5-207-4	black & white	54-55	\$32.95	
<b>Throttle Cable w/ Knob</b>				
5-208-8	stainless steel & maroon	47-53	\$32.95	
5-208-4	black w/ white "T"	54-55	\$32.95	
<b>Parking Brake Release Knob</b>				
5-210-47	chrome	47-53	\$14.95	
5-210-54	black w/white B	54-55	\$13.95	
<b>Gearshift Knob</b>				
5-211-M	maroon	48-53	\$8.95	
5-211-54	black	54-55	\$13.95	
5-0211-F	floor shift - black	40-59	\$16.95	
<b>Ashtray Knob</b>				
5-213-47	chrome	47-53	\$14.95	
<b>Steering Column Support Bolt Insulator Pads</b>				
5-0216-P	2 required @ support to dash	54-59	\$3.96	
<b>Steering Column Clamp Bushing</b>				
5-216		47-53	\$5.95	
5-216-2		54-55	\$3.95	

*Bill's Truck Shop*

Phone (905) 725-3460 / (905) 725-2022 / (905) 404-2302

# Firewall-Floor

Due to the fluctuation of the Canadian and American dollars call for current prices

Group 7

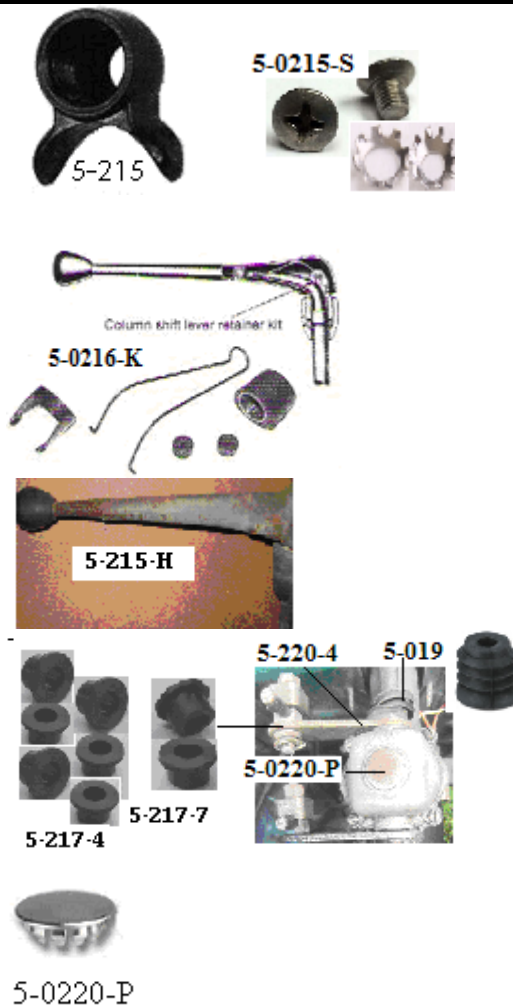

### Column Shifter Bracket

5-215 upper column at shifter handle-flange is flush w/ top of bowl

Year      New

47-55      \$34.95

### Column Shift Bracket Screws

5-0215-S ¼ x 28- 3/8 fine thread-stainless steel –now include external countersunk washer to help prevent screw from coming loose

pair      47-59      \$7.95

### Column Shift Lever Kit--

5-0216-K includes pins/springs& bushings

47-59      \$36.95

### Shift Lever Bushings w/ column shift (rubber)

5-217-4 set of 6

54-55      \$8.95

5-217-7 set of 2 @ shift box

49-53      \$4.50

### Shifter Boot at Shift Box

5-019 boot

48-59      \$4.95

5-019-S spring-prevents boot from sliding up shaft---OE GM service repair item

48-59      \$9.95

### Shifter Box Plug

5-0220-P stainless cap on 3 speed shift box

48-55      \$1.95

### Spring-shift box selector

5-0220-S

48-59      \$12.95

## Bill's Truck Shop

Phone (905) 725-3460 / (905) 725-2022 / (905) 404-2302

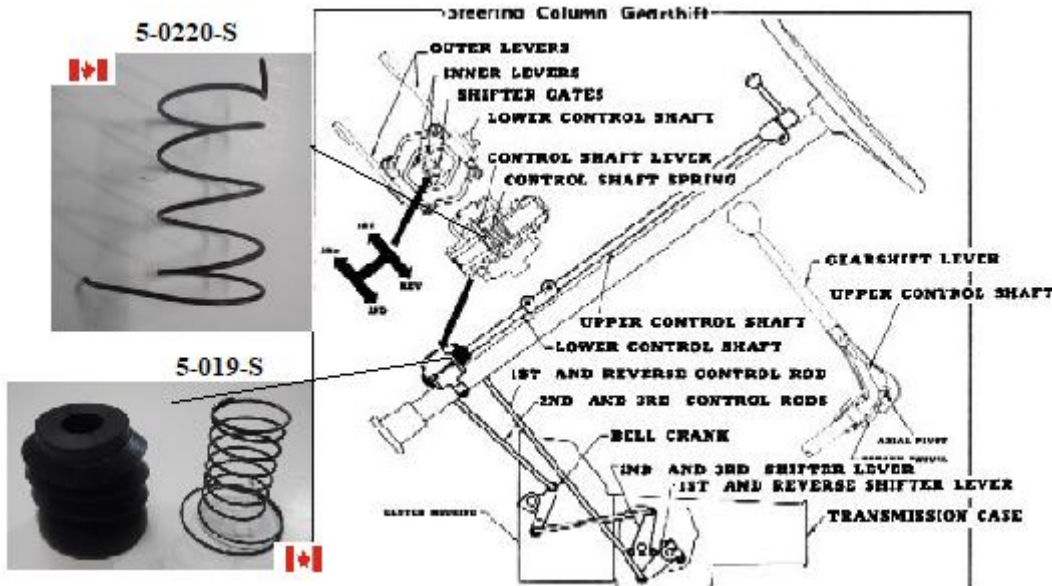

# Firewall-Floor

Due to the fluctuation of the Canadian and American dollars call for current prices

# Group 7



			<u>Year</u>	<u>New</u>
<b>Accelerator Pedal</b>				
7-201-47	accel rod secures w/ pin		47-52	\$29.95
7-0301-55	accel rod pushes into rubber		53-57	\$26.95
<b>Accelerator Rod Pin</b>				
7-0224	pin w/ cotter pin-pedal to rod		40-52	\$1.00
<b>Accelerator Pedal Pivot Pin w/cotter pin</b>				
7-0201-2			52-57	\$6.95
<b>Accelerator Pedal Shaft Floor Seal</b>				
7-0201-4			41-59	\$4.50
<b>Brake-Clutch-Park Brake Pedal Pad</b>				
7-203-1	glue on to prevent pulling off	each	47-55	\$6.95
<b>Brake &amp; Clutch Floor Shaft Seals</b>				
7-203-47		felt-pr	47-51	\$7.95
7-203-52		felt-pr	52-55	\$6.95
<b>Retainer-Brake &amp; clutch seat -w/ weld in holes</b>				
7-203-47R	1 3/4 wide	pair	47-51	\$19.95
<b>Clutch-Brake Arm Stop Bumper</b>				
7-003-S	47-53 brake arm only	each	47-59	\$2.95
<b>Clutch-Brake Arm Stop Bumper</b>				
7-003-S	47-53 brake arm only	each	47-59	\$2.95
<b>Brake &amp; Clutch Pedal Bushings (pair)</b>				
7-203-B	brass oversize to repair worn shaft-machine as nec		47-55	\$33.95

*Bill's Truck Shop*

Phone (905) 725-3460 / (905) 725-2022 / (905) 404-2302

FUR ATTACHMENT SEE  
BOOK 3707901-SECTION 1  
SHEET 3. 03

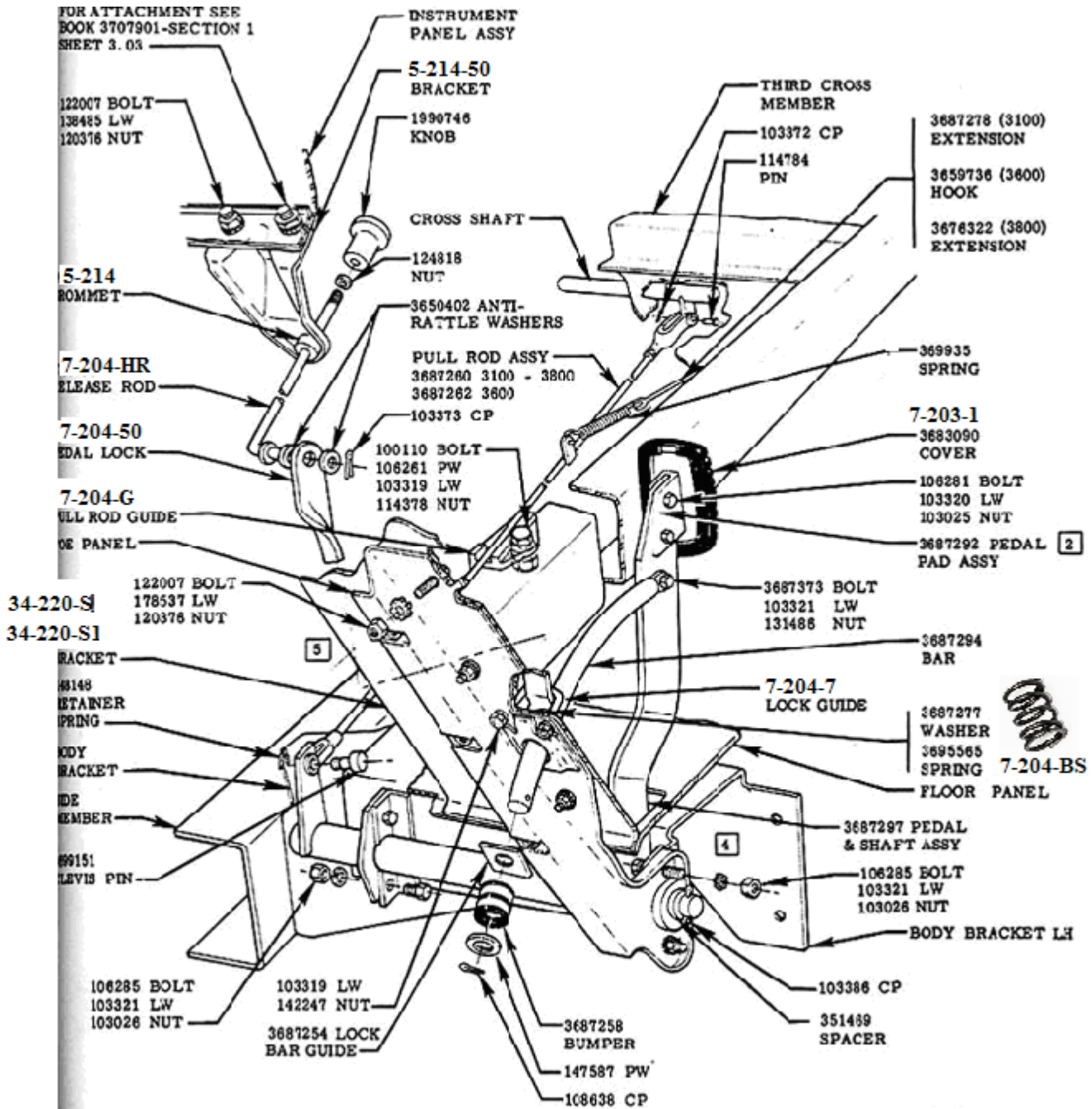

late 1948-55 Park Brake Instruction

**MODELS**  
3102 - 3602 - 3802

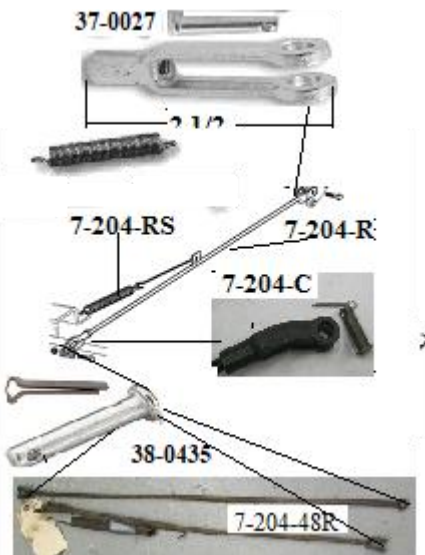
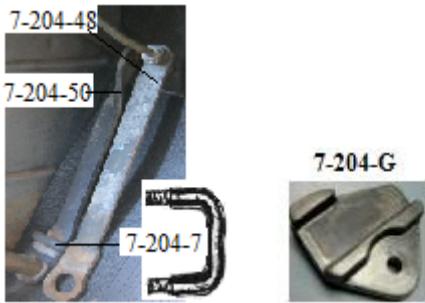

**Parking Brake Control Rod**-includes rod, clevis and spring-47 has pull lever park brake and early 48-49 had 2 pc rod

		<u>Year</u>	<u>New</u>	<u>Used</u>
7-204-R	short bed	48-55		\$199.95

**Parking brake rod clevis yoke w/ pin @ cross bar**

7-204-C	5/16 NF	curved end	47-55	\$19.95
---------	---------	------------	-------	---------

37-0027	2 1/2" long w/ pin	each 5/16 NF	47-55	\$19.95
---------	--------------------	--------------	-------	---------

**Park Brake Rod Return Spring w/ extension rod**

7-204-RS			48-55	\$19.95
----------	--	--	-------	---------

**Parking Brake Rod Guide**

7-204-G	locates rod on frame		48-55	\$9.50
---------	----------------------	--	-------	--------

**Pin-cable yoke end**

38-0435	5/16 x 1 1/4		47-55	\$1.45
---------	--------------	--	-------	--------

**Parking Brake Release Lock Guide U-Bolt**

7-204-7	includes hdw		48-55	\$36.95
---------	--------------	--	-------	---------

**Parking Brake Release Lock Guide U-Bolt**

7-204-7	includes hdw		48-55	\$36.95
---------	--------------	--	-------	---------

**Spring-parking brake bar spring @ firewall**

7-204-BS	OE # 3695565		48-55	\$8.95
----------	--------------	--	-------	--------

**Support-inner fender w/ park brake**

34-220-S	on left firewall for inner fender & park support		48-55	\$99.95
----------	--------------------------------------------------	--	-------	---------

34-220-S1	new replacement inner to outer fender support when NOT installing the OE style park brake assembly and trucks w/ park at trans-left side		48-55	\$34.95
-----------	------------------------------------------------------------------------------------------------------------------------------------------	--	-------	---------

**NOTE-1947 & early 48 had park brake on floor next to trans shifter & OE in fenders were longer to cab-requires this bkt to install 49-55 inner fender on 47-48 trucks,panels,surburbans**

*Bill's Truck Shop*

Phone (905) 725-3460 / (905) 725-2022 / (905) 404-2302



		<u>Year</u>	<u>New</u>
<b>Parking Brake Rod Seal Bumper &amp; Pin</b>			
7-204-1		48-55	\$9.95
<b>Parking Brake Handle Rod Grommet</b>			
5-214	at column support	48-55	\$1.95
<b>Parking Brake Lever Boot</b>			
7-204-4		48-55	\$10.95
<b>Parking Brake Lever Boot Retainer</b>			
7-204-5	w/screws (3)	48-55	\$15.95
<b>Boot Retainer Screws</b>			
7-204-6	stainless –slot head set of 3	48-55	\$0.95
<b>Cover-park brake pedal w/ screws</b>			
7-204-PC	used on all trans park brake & custom park brake	48-55	\$14.95
<b>Steering Column to Floor Seal w/ flange &amp; screws</b>			
7-208-4	column shift	47-55	\$24.95
7-208-5	floor shift	47-55	\$24.95
<b>Column Flange Screw Set</b>			
7-208-6	2 pcs	47-55	\$0.95
<b>Starter Pedal Pad</b>			
7-0315-P	w/ foot pedal start-rubber	47-59	\$7.95
<b>Starter Bellows</b>			
7-0315		47-59	\$11.95
<b>Clutch Head Driver Set</b>			
5-0CHSD-4	4 x screw drivers	47-61	\$34.95
5-0CHS-4	4 x 3/8 drive sockets	47-61	\$34.95

# Floor-Firewall

Due to the fluctuation of the Canadian and American dollars call for current prices

# Group 8



	<u>Year</u>	<u>New</u>	<u>Used</u>
<b>Master Cylinder Access Plug-rubber w/ steel reinforcement-some OE all steel available used</b>			
8-0325	47-59	\$11.95	
<b>Vacuum Hose Firewall Grommet for vac wipers</b>			
8-206 11/ 16 hole dia	47-55	\$2.95	
<b>Main Wire Harness Firewall Grommet</b>			
8-0105	36-59	\$3.95	
<b>Main Supply &amp; Ignition Wire Firewall Grommet-left upper cowl</b>			
8-206-2 starter to ammeter wire & coil wire	47-55	\$2.50	
<b>Four Hole Firewall Grommet</b>			
8-206-3 4 hole-choke-throttle-temp line etc	47-49	\$3.75	
8-0206-4 temp line/choke/throttle fits 1 ' hole	50-59	\$4.95	
<b>Speedometer Cable Grommet</b>			
4-0208-5 cut on angle to center to install over cable	47-55 60-72	\$2.95	
<b>Firewall Grommet kit</b>			
8-206-47K includes 8-206/8-0105/8-206-2 x 2/8-0206-3 & 4-0208-5 6 pcs	47-49	\$20.95	
8-206-50K includes 8-206/8-0105/8-206-2 x 2/8-0206-4 & 4-0208-5 6 pcs	50-55	\$20.95	
<b>Horn Wire Grommet</b>			
8-206-4 in firewall/dash brace	47-55	\$2.50	

## Bill's Truck Shop

Phone (905) 725-3460 / (905) 725-2022 / (905) 404-2302

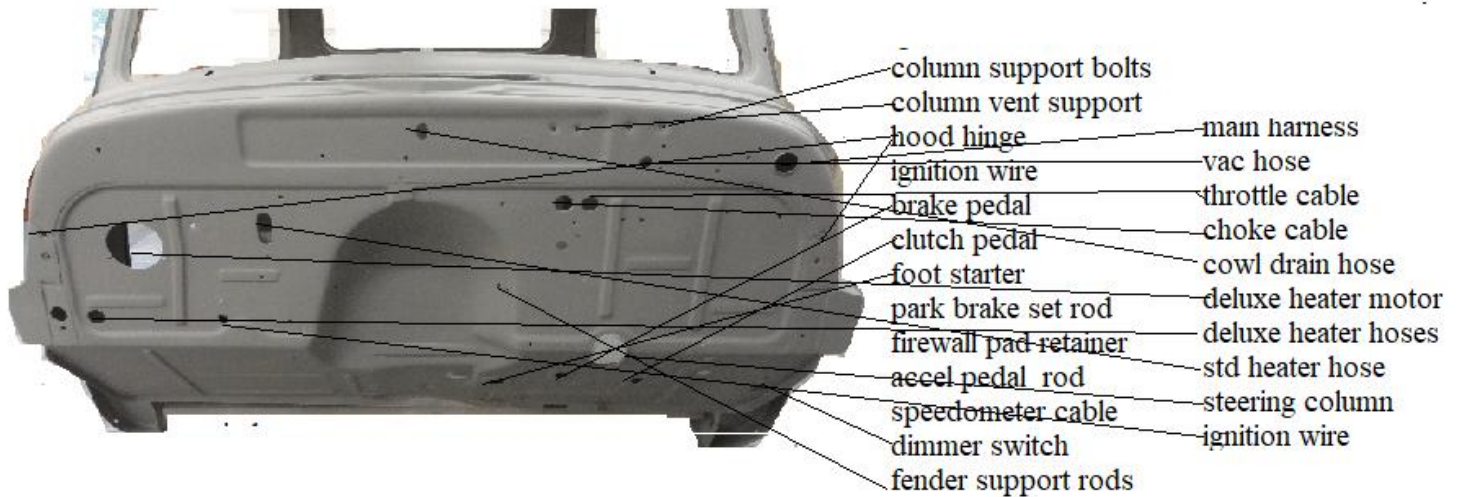

# Floor-Firewall

Due to the fluctuation of the Canadian and American dollars call for current prices

Group 8

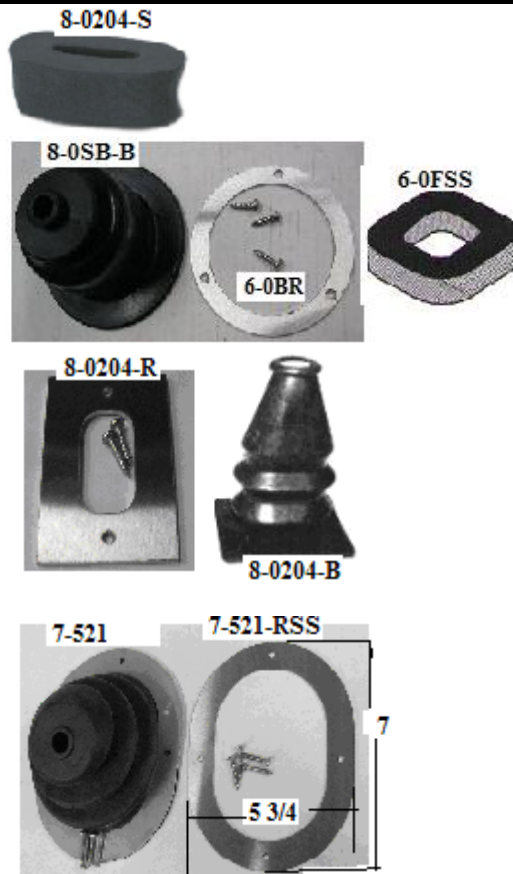

		<u>Year</u>	<u>New</u>	<u>Used</u>
<b>Floor Shift Sponge Seal</b>	4 speed			
6-0FSS-37	w/ 3 speed floor shift	37-49	\$14.95	
6-0FSS		50-66	\$9.95	
<b>Floor Shift Boot</b>				
8-0SB-C	w/ Chev logo	47-66	\$22.95	
<b>Floor Shift Boot Retainer</b>				
6-0BR	14G brushed stainless steel w/screws	47-66	\$29.95	
<b>Hand Brake Sponge Seal</b>				
8-0204-S	floor mounted	37-59	\$5.95	
<b>Hand Brake Boot</b>				
8-0204-B		47-59	\$18.95	
<b>Hand Brake Boot Retainer w/ screws</b>				
8-0204-R	14G brushed stainless steel w/screws	47-59	\$19.95	
<b>Shifter Boot-replacement for any 4-5 speed std trans</b>				
7-521	Shifter Boot		\$44.95	
7-521-RSS	retainer-stainless steel w/ hdw		\$29.95	
<b>Transmission Floor Cover</b>	½ -1 ton			
8-208	column shift	47-55	\$104.95	
8-208-1	4-speed	47-55	\$119.95	
<b>Transmission Floor Cover Gasket</b>				
8-208-2		47-55	\$9.95	
<b>Transmission Floor Cover Screw Set (11)</b>				
8-208-3		47-55	5.95	

*Bill's Truck Shop*

Phone (905) 725-3460 / (905) 725-2022 / (905) 404-2302

# Battery Tray - Cables

Due to the fluctuation of the Canadian and American dollars call for current prices

Group 8



## Battery Compartment Cover

8-209 pickup & panel/suburban and under driver seat - tool storage 47-55 \$124.95

OE Spring-battery cover retainer-secures cover to floor -usually missing on good used covers 2 required for OE covers-does not apply to repro covers

8-209-S each 47-55 \$12.95

## Battery Cover Seal

8-209-1 47-55 \$14.95

## Battery Top Hold Down

8-209-2 47-55 \$30.95

## Battery Hold Down Corner Pad set of 4

8-209-3 47-55 \$14.95

## Battery Hold Down Nuts

8-0209-4 wing nuts w/ washer seat--- pair 47-55 \$1.75

## Battery Tray Bottom

8-209-5 47-55 \$28.95

## Battery Box - frame mount assembly

8-209-6 9 1/4 wide x 7 1/4 deep 47-55 \$89.95

## Ground Strap-Battery braided strands as original

8-0462 Battery to Frame 14" 47-59 \$59.95

8-0463 Engine to Frame 12" 47-59 \$39.95

## Battery Positive Cable

8-201-B #1 gauge w/o black cloth cover 34" long 47-55 \$47.95

8-201-BS #1 gauge 34" long cloth covered 47-55 \$62.95

NOTE-- the lower # gauge wire the bigger the wire is in size-important when using 6 volt systems

## Battery Cable End-replacement clamp style

8-0880 battery cable end \$3.95

## Battery Cable Cover-top post/slip on

8-0760-R red/positive \$3.25

8-0760-B black/neg \$3.25

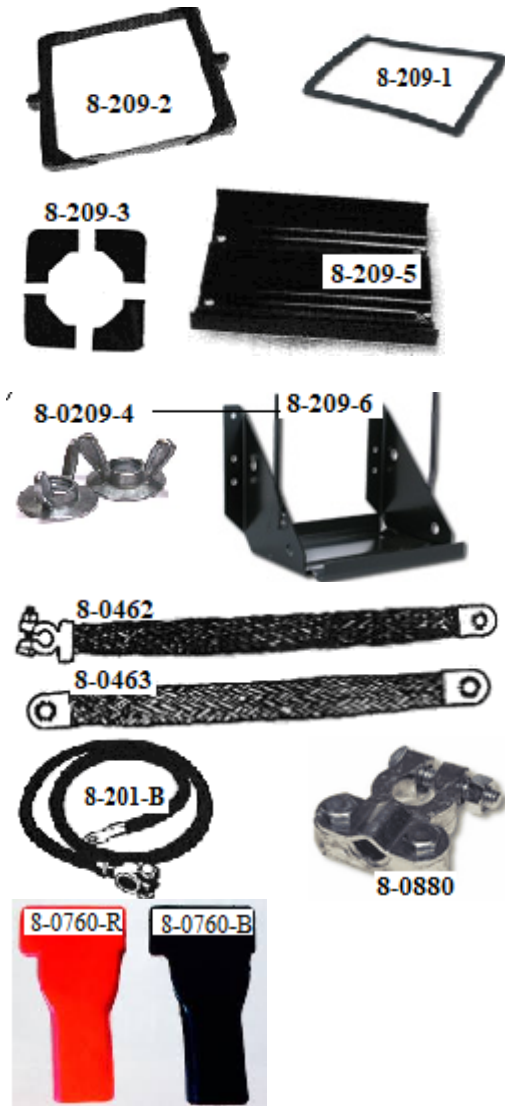

Bill's Truck Shop

Phone (905) 725-3460 / (905) 725-2022 / (905) 404-2302

# Glove Box Door/Dash

Due to the fluctuation of the Canadian and American dollars call for current prices

Group 9

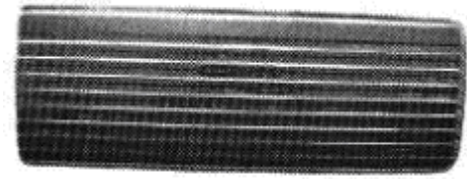

9-201



9-201-1



9-201-47T



9-201-6



9-201-47H

5-0GBB



9-201-11

5-0224

9-201-H



9-201-9

9-201-7

5-0222

5-0223



9-0201-13



5-0GBL

9-201-L

		<u>Year</u>	<u>New</u>
<b>Glove Box Door</b>			
9-201	Chev-GMC –stainless steel w/painted details	47-53	\$199.95
9-201-SS	Chev-GMC/ stainless steel	47-53	\$179.95
<b>Glove Box Hinges</b>			
9-201-47H	pr of side arms w/hdw	47-53	\$69.95
<b>Glove Box Hinge Screw set</b>			
9-201-47HS	arm screw set 8 pcs w/ washers	47-55	\$4.95
<b>Glove Box Liner – cardboard- assembled with clip nuts installed &amp; screws</b>			
9-201-1	Chev	47-49	\$29.95
9-201-1G	GMC	47-49	\$29.95
9-201-2	Chev / GMC	50-53	\$34.95
9-201-3	Chev	54-55	\$34.95
9-201-4	GMC	54-55	\$29.95
<b>Glove Box Screw set</b>			
9-201-6	9 screws	47-49	\$3.95
9-201-5	6 screws	50-55	\$5.95
<b>Glove Box Liner Trim w/ screws</b>			
9-201-47T	replacement retainer that hold liner to dash-22 gauge satin coat steel-paint as required-NEW satin coat	47-49	\$18.95
<b>Glove Box Door Bumpers</b>			
5-0GBB	pair	47-72	\$2.50
<b>Glove Box Lock &amp; Key w/ original style key</b>			
9-201-7		40-53	\$42.95
5-0221	w/o key	54-72	\$35.95
5-0222	w/ 2 keys	54-72	\$45.95
<b>Glove Box Lock Gasket</b>			
9-201-9		47-53	\$0.95
5-0223		54-72	\$1.50
<b>Glove Box Lock Retainer Bracket W/ Screws</b>			
9-201-11		47-53	\$9.99
5-0224		54-72	\$4.50
<b>Glove Box Lock Striker w/screws</b>			
9-0201-13		54-59	\$9.95
<b>Glove Box J-Hook &amp; Slide</b>			
9-201-H		47-53	\$4.95
<b>Glove Box Light Kit</b>			
9-201-L	switch, support & harness	47-53	\$39.95
5-0GBL		54-72	\$23.95

*Bill's Truck Shop*

Phone (905) 725-3460 / (905) 725-2022 / (905) 404-2302

# Interior Parts

Due to the fluctuation of the Canadian and American dollars call for current prices

Group 10

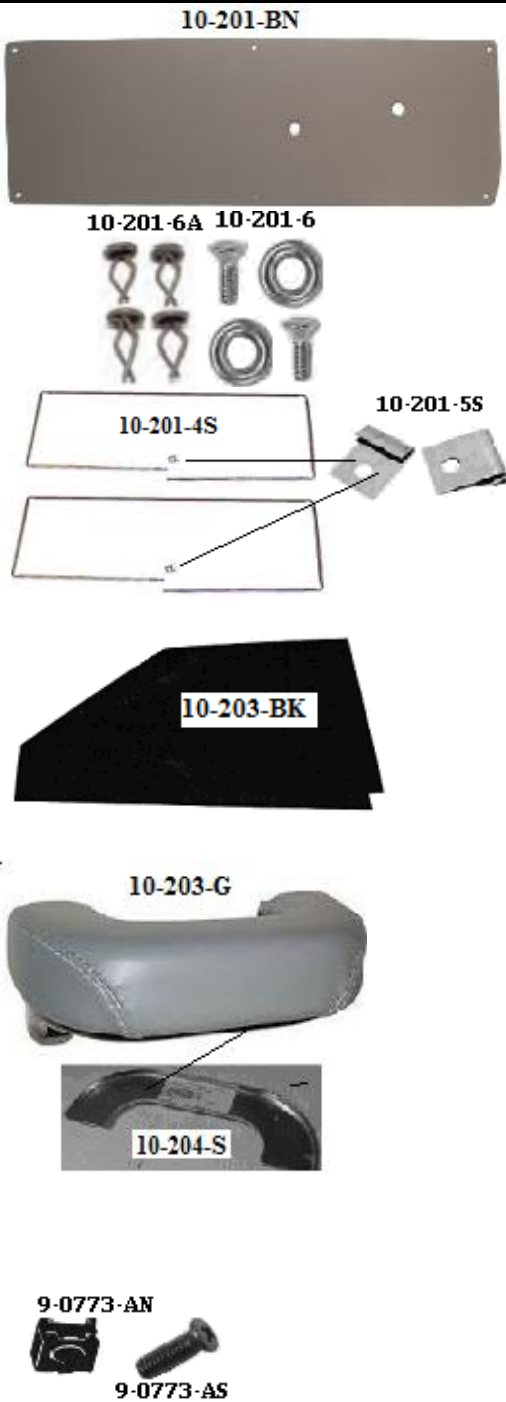

		<u>Year</u>	<u>New</u>
<b>Door Panels</b> Pre-cut cardboard punched panels-pair			
<b>Standard</b> comes in flat finish			
10-201-BK	black	47-55	\$24.95
10-201-BN	brown	47-55	\$24.95
10-201-LG	light grey	47-55	\$24.95
<b>Deluxe</b> Leather Style grain (pair)			
10-202-BK	black	47-55	\$49.95
10-202-BN	brown	47-55	\$49.95
10-202-M	maroon	47-55	\$44.95
10-202-G	grey	47-55	\$44.95
10-202-BU-special order	blue	47-55	\$44.95
10-202-GN-special order	green	47-55	\$44.95
<b>Door Panel Metal Frames</b> w/ clips (pair)			
10-201-4S	steel/zinc coated	47-55	\$54.95
10-201-4SS	stainless steel	47-55	\$89.95
<b>Door Panel Metal Frame Clips</b> (pair)			
10-201-5S	steel	47-55	\$3.25
10-201-5SS	stainless steel	47-55	\$3.50
<b>Door Panel Fasteners</b>			
10-201-6	stainless steel screws & washers	47-53	\$11.95
10-201-6A	brown push in clips/ 12	54-55	\$9.95
<b>Kick Panel</b> (pair)			
10-203-BK	black	47-55	\$34.95
10-203-BN	brown	47-55	\$34.95
10-203-G	grey	47-55	\$34.95
<b>Arm Rest</b> w/ instruction & hdw-black bases -- each			
10-204-BK	black	47-55	\$79.95
10-204-BN	brown	47-55	\$69.95
10-204-M	( special order) maroon	47-55	\$69.95
10-204-G	grey	47-55	\$69.95
10-204-BG	(special order) blue/green	47-55	\$79.95
<b>Armrest Support Plate</b> -steel plate to reinforce plastic base			
10-204-S	each	47-55	\$19.95
<b>Armrest Screw</b>			
9-0773-AS	¼ x 20 x 1 1/4 Philips screw	pair 47-72	\$2.00
<b>Armrest Nut</b>			
9-0773-AN	cage nut	pair 47-72	\$4.95

*Bill's Truck Shop*

Phone (905) 725-3460 / (905) 725-2022 / (905) 404-2302

# Interior Parts

Due to the fluctuation of the Canadian and American dollars call for current prices

Group 10

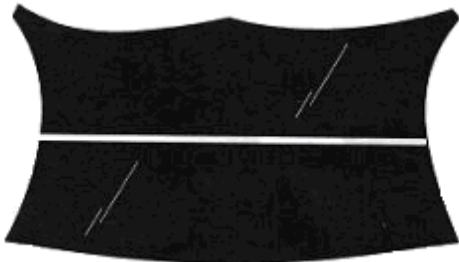

10-205



10-208-BK



10-201-BK



Year      New      Used

**Headliner** Cut to exact size.  
49's specify screw-in center bow (early type) or floating center bow (late type)

Rear section 16 deep

10-205-BK	black	47-early 49	\$74.95
10-205-BN	brown	47-early 49	\$49.95
10-205-LG	light grey	47-early 49	\$49.95
10-205-PB	pearl beige	47-early 49	\$74.95

Rear section 14 " deep

10-206-BK	black	late 49-53	\$74.95
10-206-BN	brown	late 49-53	\$74.95
10-206-LG	light grey	late 49-53	\$74.95

10-206-PB	pearl beige	Late 49-53	\$74.95
10-207-BK	black	54-55	\$74.95
10-207-BN	brown	54-55	\$74.95
10-207-LG	light grey	54-55	\$74.95
10-207-PB	pearl beige	54-55	\$49.95
10-207-BG	blue/green > <b>special order</b>	54-55	\$74.95

**Panel Truck** 2 pc set-----**SPECIAL ORDER**

10-208-BK	black	47-early 49	\$69.95
10-208-BN	brown	47-early 49	\$69.95
10-208-LG	light grey	47-early 49	\$69.95
10-208-BK-50	black	late 49-53	\$119.95
10-208-BN-50	brown	late 49-53	\$119.95
10-208-LG-50	light grey	late 49-53	\$119.95

10-209-BK	black	54-55	\$89.95
10-209-BN	brown	54-55	\$89.95

**Suburban** 5 pcs

			Inquire
10-210-BK	black	47-53	\$279.95
10-210-BN	brown	47-53	\$279.95
10-210-LG	light grey	47-53	\$279.95
10-211-BN	brown	54-55	\$279.95
10-211-BK	black	54-55	\$279.95

*Bill's Truck Shop*

Phone (905) 725-3460 / (905) 725-2022 / (905) 404-2302

# Interior

Due to the fluctuation of the Canadian and American dollars call for current prices

# Group 11

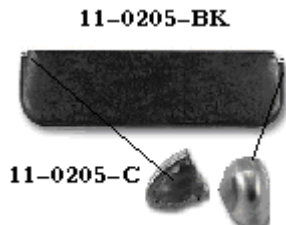
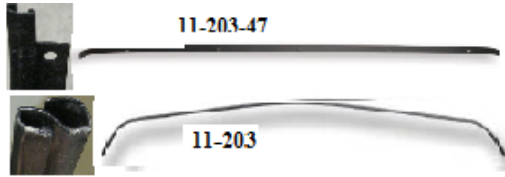
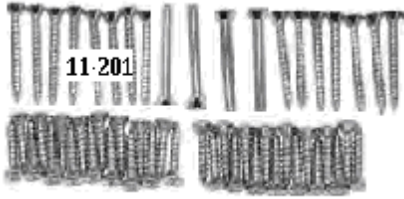

include w/ new visors



includes screws w/ new

## Interior Trim Screw Kit

windshield & door inner trim-stainless steel

		Year	New
11-201	51 pcs	47-53	\$19.95
11-201-54	33 pcs	54-55	\$8.95

## Center Headliner Retainer

11-203-47	secured w/ 7 screws	47-early 49	\$59.95
11-203	floating "S"	49-55	\$59.95

## Rear Headliner Retainer

11-203-50R	secured w/ 11 screws	49-55	\$74.95
------------	----------------------	-------	---------

## Headliner Retainer Screw Kit

11-203-C	center retainer-stainless steel (7)	47-49	\$2.50
11-203-R	rear retainer- stainless steel (10)	47-49	\$2.95
11-203-50	rear- black (11)	49-55	\$4.95
11-203-50S	rear- stainless steel (11)	49-55	\$5.95

## Covered Sun Visor w/ end clips each

11-0205-BK	black	47-59	\$54.95
11-0205-BR	brown	47-59	\$49.95
11-0205-G	grey	47-59	\$49.95
11-0205-M	maroon	47-59	\$49.95
11-0205-R	red	47-59	\$49.95

**Sun Visor End Clips** Stain- steel end clips for uncovered visor

11-0205-C	pair	47-66	\$3.50
-----------	------	-------	--------

**Sun Visor Bracket** includes screws-bright chrome like finish NOT like OE

11-205-L	left	47-53	\$33.95
11-205-R	right	47-53	\$33.95
11-205-1L	left	54-55	\$33.95
11-205-1R	right	54-55	\$33.95

## Sun Visor Bracket Screw kit

11-0205-2	3 pcs	47-59	\$1.25
-----------	-------	-------	--------

1955 year is 1<sup>st</sup> series not second series 1955-59

## Bill's Truck Shop

Phone (905) 725-3460 / (905) 725-2022 / (905) 404-2302



11-206-DSV



11-207-K



madrid vinal



11-0SC

## SEAT COVERS

**Seat Cover** *Heavy Duty vinyl similar to original colour and grain w/stitched foam backing*  
**Madrid vinyl** *inquire about other colour combinations---USA made includes foam uderpadding*

		<u>Year</u>	<u>New</u>
11-206-DSV	dark saddle non-pleated vinyl	47-55	\$449.95
11-206-DSV-P	dark saddle pleated vinyl	47-55	\$445.95
11-206-BKV-P	black pleated vinyl	47-55	\$445.95
11-206-BKV	black non-pleated vinyl	47-55	\$339.95
11-206-MV-P	maroon pleated vinyl	47-55	\$445.95
11-206-MV	maroon non-pleated vinyl	47-55	\$449.95
11-206-GV	medium gray vinyl non pleated	47-55	\$399.95

## Seat Upholstery Installation Kit

11-207-K	includes burlap and cotton padding	47-55	\$36.95
----------	------------------------------------	-------	---------

## Seat to Frame Clip kit

11-0SC	70 pcs	37-59	\$18.50
--------	--------	-------	---------

*Bill's Truck Shop*

Phone (905) 725-3460 / (905) 725-2022 / (905) 404-2302

# Interior-Seats-hardware

Group 11

		<u>Year</u>	<u>New</u>
<p>11-208</p>  <p>11-0209</p>  <p>11-0307-S</p> <p>11-208-1</p>   <p>8-0070</p>	<p><b>Seat Frame Bumpers and Screws</b> between upper seat frame and cab.</p> <p>11-208 pair</p> <p><b>Seat Adjustment Rod Grommet</b></p> <p>11-208-1</p> <p><b>Seat Spring Tie Clip</b></p> <p>11-0209 secures spring together set of 3</p> <p><b>Spring-seat track adjust</b></p> <p>11-0307-S one per side</p> <p><b>Screws-seat upper retaining</b></p> <p>11-207-US 3 x 10-24 screws</p>	<p>47-55</p> <p>50-54</p> <p>47-72</p> <p>47-55</p> <p>47-55</p>	<p>\$8.95</p> <p>\$4.25</p> <p>\$2.95</p> <p>\$11.95</p> <p>\$1.25</p>
<p>11-207-US</p>  <p>11-207-SF</p> 	<p><b>Seat Adjuster kit-replacement for rod style</b></p> <p>8-0070 Cable-seat adjust kit w/ adjustable turnbuckle</p>	<p>50-87</p>	<p>\$12.95</p>
 <p>11-207-PR</p>	<p><b>Seat-upper &amp; lower</b></p> <p>11-207-PR</p>	<p>47-55</p>	<p>1655.0</p>

*Bill's Truck Shop*

Phone (905) 725-3460 / (905) 725-2022 / (905) 404-2302

# Interior-Seats-hardware

Group 11

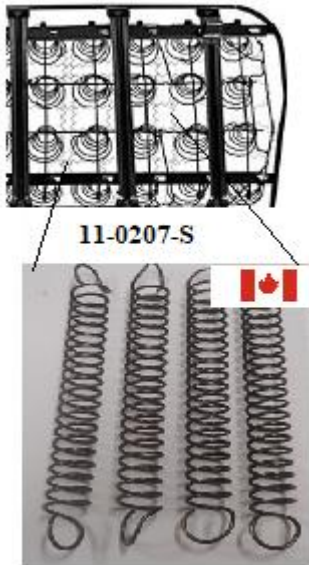

### Screws-seat upper retaining

		<u>Year</u>	<u>New</u>
11-207-US	3 x 10-24 screws	47-55	\$1.25

### Springs NEW

11-0207-S	spring-seat base tension spring-set of 4	Secures the standing coil springs	47-59	\$14.95
-----------	------------------------------------------	-----------------------------------	-------	---------

### Spring-Seat handle-lock return

11-207-HS	one on each track	each	47-55	\$9.95
-----------	-------------------	------	-------	--------

### Seat Track---requires kit # 11-207-50HK

11-207-47T	OE was cable adjust side to side		47-50	
11-207-50T	50-55 OE was rod adjust side to side—pair use as replacement for all years		47-55	\$234.95

### Nut kit-seat track

11-207-50HK	cab base & seat base	12 pcs	47-55	\$11.95
-------------	----------------------	--------	-------	---------

*Bill's Truck Shop*

Phone (905) 725-3460 / (905) 725-2022 / (905) 404-2302



11-211



11-212-FM



11-0HSD



11-213-53



11-213-R

11-0213-S



10782

**Inquire about any other colours not listed**

Year

New

**Carpet with Underlay-** Cut to fit with edges sewn & heel pad- can be special ordered w/o seat frame (add F) and w/o gas tank in cab 49-55

Available in **cut pile or loop pile**

**Can also be ordered w/o pedal holes**

11-210-G	loop pile w/ seat frame	grey	47-55	\$299.95
11-210-BL	loop pile w/ seat frame	black	47-55	\$289.95
11-210-BR	loop pile w/ seat frame	brown	47-55	\$299.95

Other colours available on special order

11-210-BL-F-T	black w/o seat frame & tank in cab		47-55	\$319.95
	grey w/o seat frame & tank in cab		47-55	\$289.95

**CARPET- 2 yards – call for other colours**

8-000Y-01	black-loop pile approx 80 “ x 72”			\$144.95
-----------	-----------------------------------	--	--	----------

**Rubber Floor Mat-black** no holes are cut in mat-there are die-stamped markers where holes can be cut out –fits all models accept COE

11-211	auto & standard trans		47-55	\$259.95
--------	-----------------------	--	-------	----------

**Felt Mat**

11-212-FM	felt underlay for rubber mat		47-55	\$44.95
-----------	------------------------------	--	-------	---------

11-0HSD	Universal heat & sound insulation – 3/8 single sided foil backed w/ jute liner 4 x 6			\$52.95
---------	--------------------------------------------------------------------------------------	--	--	---------

**Inner Firewall Cover** Pre-cut rubber and felt

11-213-53	firewall holes must be enlarged for plastic retainers		47-53	\$89.95
11-213-54	firewall holes must be enlarged for plastic retainers		54-55	\$89.95

**Inner Firewall Cover Retainers**

11-213-R	set of 8 plastic		47-53	\$10.95
11-213-54R	set of 9 plastic		54-55	\$11.95
11-0213-S	steel original type each		47-59	\$6.50

10782	Dimmer switch grommet ( included w/new carpet)			\$8.95
-------	------------------------------------------------	--	--	--------

# Interior-Seat Belts

# Group 11

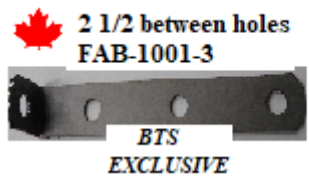

When ordering seat belts there are many issues that will have to be addressed –eg-buckets-bench-height of seat-mount location etc / note- 3 point system lock buckle must be on side of person

Some applications may require an extender-see below for 6” metal ext or 12” belt extension

**Belt Extension w/ hdw**

Part Number	Color	Price
SB-12XBK	black	\$24.95
SB-12XBL	navy blue	\$24.95
SB-12XR	red	\$24.95
SB-12XT	tan	\$24.95
SB-12XG	gray	\$24.95

**Metal Extension**

FAB-1008-1	1 “ 90 deg “ ext	\$11.95
FAB-1001-3	8 “ ext w/3 holes @ 2 1/2 apart- cut to desired length as required	\$11.95

**Seat Belts /lap style-w/ hdw.-per person**

Push button STD ( coloured) 22”long w/female end & 38” long w/ male end // or lift lever ( chrome) type DLX 22” long male end & 38” long female end- 60 “ DLX 42” long male end & 30” long female end-72”

SB-N2PB	black w/ std buckle	\$79.95
SB-N2PR	red w/ std buckle	\$79.95
SB-N2PG	grey w/ std buckle	\$79.95
SB-N2PT	tan w/ std buckle	\$79.95
SB-N2PN	navy blue w std buckle	\$79.95
SB-N2PM	maroon w/ std buckle	\$79.95
SB-N2LB	black w/chrome buckle	\$89.95
SB-N2LB-72	black w/chrome buckle 72” long	\$89.95
SB-N2LG	grey w/ chrome buckle	\$89.95
SB-N2LN	navy blue w/chrome buckle	\$59.95
SB-N2LN-72	blue w/chrome buckle 72” long	\$59.95
SB-N2LR	red w/ chrome buckle	\$89.95
SB-N2LTAN	tan w/ chrome buckle	\$89.95

## Bill's Truck Shop

Phone (905) 725-3460 / (905) 725-2022 / (905) 404-2302

# Interior-Seat Belts

# Group 11

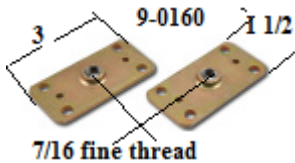
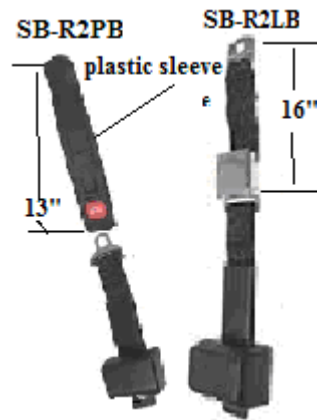

When ordering seat belts there are many issues that will have to be addressed –eg-buckets-bench-height of seat-mount location etc / note- 3 point system lock buckle must be on side of person

Some applications may require an extender-see below for 6” metal ext or 12” belt extension

2-point retractable w/ hdw-- 13 “ female w/ plastic sleeve-16” w/loose end

Push button STD or lift lever ( chrome) type DLX

			<u>Year</u>	<u>New</u>
SB-R2PB	black w/ std buckle	each		\$149.95
SB-R2PR	red w/ std buckle	each		\$149.95
SB-R2PG	grey w/ std buckle	each		\$149.95
SB-R2PT	tan w/ std buckle	each		\$149.95
SB-R2PM	maroon w/ std buckle	each		\$149.95
SB-R2PN	blue w/ std buckle	each		\$149.95
SB-R2LB	black w/ dlx	each		\$159.95
SB-R2LR	red w/ dlx	each		\$144.95
SB-R2LG	gray w/ dlx	each		\$144.95
SB-R2LT	tan w/ dlx	each		\$144.95

3-point retractable w /hdw and chrome lift latch ( air plane style) approx 24” inner female

SB-R3LB	black w/ chrome buckle	each		\$249.95
SB-R3LDB	dark blue w/chrome buckle	each		\$186.95

3-point retractable w /hdw

Push button STD ( coloured) or lift lever ( chrome) type DLX approx 10” inner female

SB-R3PB	black w/ std buckle	each		\$214.95
SB-R3PG	gray w/ std buckle	each		\$214.95
SB-R3PM	maroon w/ std buckle	each		\$214.95
SB-R3PT	tan w/ std buckle	each		\$214.95
SB-R3PN	navy blue w/ std buckle	each		\$214.95

### Anchor Plates

9-0160	w/ shoulder belt -7/16 fine thread / pr	47-66		\$34.95
--------	-----------------------------------------	-------	--	---------

Seat Belt Retractors-pr a reproduction of an OE option- for non retractable seat belts-prevents belt from falling out vehicle doors

9-0SBR	pair			\$34.95
--------	------	--	--	---------

*Bill's Truck Shop*

Phone (905) 725-3460 / (905) 725-2022 / (905) 404-2302

# Door/Window Parts

Due to the fluctuation of the Canadian and American dollars call for current prices

Group 12



			<u>Year</u>	<u>New</u>
<b>Inside Door Handle</b> w / set screw				
12-01DH	chrome		47-66	\$29.95
<b>Inside Window Handle</b> w/ set screw				
12-01WH	chrome w/ black knob		47-66	\$29.95
<b>NOTE</b> -check for wear on shaft splines –handles must slide on without excessive play-set screw to seat in groove-not splines				
<b>Inside Handle Gasket Set</b>				
12-01HG	sponge seals & fibre washers-4 handles		47-66	\$10.95
<b>Interior Handle Escutcheon</b>				
12-01HE	off white	each	47-87	\$2.95
<b>Inside Handle Set Screw for OE handles only-some applications used a 2<sup>nd</sup> lock set screw above</b>				
12-0204	¼ x 20 hex head	each	47-66	\$0.60
12-0204-S	set screw 1/4-20x3/8		47-66	\$1.00
<b>Outside Door Handles (with mounting gaskets)</b>				
12-205	turns down handles	pair	47-51	\$109.95
12-0107	pushbutton w/o right side button / lock	pr	52-59	\$99.95
<b>Outside Door Lock With Key (2 keys) each</b>				
12-205-1	in right door below handle also used on panel-suburban rear door	includes 2 keys	47-51	\$69.95
12-205-3	one lock w/ 2 keys		52-55	\$144.95
12-205-4	with 2 matching locks & keys		52-55	\$144.95
12-205-47K	w-1 dr/1 ign/ 1 glove box lock & 2 keys		47-51	\$129.95
12-205-52-K	w-2dr/1 ign / 1 glove box lock & 2 keys		52-53	\$159.95
12-205-54-K	w-2dr/1 ign/1 glove box lock cyl-2 keys		54-55	\$159.95
<b>Door Lock Gasket</b>				
12-205-1G			42-51	\$1.95
<b>Rear Door Handle &amp; Lock Gasket</b>				
12-205-LHG	panel-suburb rear door	2pcs	47-55	\$2.95
<b>Door Lock Retainer</b>				
12-205-1R	U-clip in door end to secure lock in door		47-51	\$12.95
<b>Outside Handle Gasket Set</b>				
12-205-5	moulded rubber w/ lock gasket		47-51	\$4.50
12-0205	w/o-ring for lock		52-66	\$5.95
<b>Outside Handle Scratch Shields - chrome plated</b>				
12-0185		pair	52-59	\$46.95

*Bill's Truck Shop*

Phone (905) 725-3460 / (905) 725-2022 / (905) 404-2302

# Door/Window Parts

Due to the fluctuation of the Canadian and American dollars call for current prices

# Group 12



		<u>Year</u>	<u>New</u>
<b>Door Hinge Bolts</b> (each) pickup truck			
12-0207-B	3/8 x 1 fine thread w/washer--each	47-55	\$1.15
12-0307-CN	3/8 fine thread rectangular nut each	47-54	\$17.95
<b>Door Hinges</b>			
12-207-LU	left upper w/ check springs	47-55	\$124.95
12-207-RU	right upper w/check springs	47-55	\$124.95
12-207-LL	left lower	47-55	\$124.95
12-207-RL	right lower	47-55	\$124.95
<b>Door Hinge Rebuilt Kit</b>			
12-0HPK	2 (11/32) pins / 4 (13/32) OS brass bushing	47-91	\$14.95
<b>Door Hinge Springs</b>			
12-207-2	on upper hinge-pair	47-55	\$10.95
<b>Lower Door Access Panels</b> (each)OE has 1/4 hole for machine screw & 54-55 has hole for # 8 screw			
12-207-47L	left	47-55	\$89.95
12-207-47R	right	47-55	\$89.95
<b>Lower Door Hinge Access Panel Screws</b> -both sides			
12-207-4	1/4 machine screw -stainless steel 10 pcs	47-53	\$8.95
12-207-5	OE doors have #8 screw 10 pcs	54-55	\$3.45
<b>Door Latch Spring</b>			
12-208	on latch to prevent handle sag	47-51	\$9.95
<b>Door Latch Screw Kit</b>			
12-208-2	2 doors 8 pcs	47-51	\$9.95
12-0208-3	3pcs	52-59	\$3.45
<b>Door Latch Repair Clip</b> Fits over worn tumbler			
12-0DLC	corrects a lot of door closing issues each	47-63	\$12.95

*Bill's Truck Shop*

Phone (905) 725-3460 / (905) 725-2022 / (905) 404-2302

# Door/Window Parts

Due to the fluctuation of the Canadian and American dollars call for current prices

Group 12



**Door Latch-- Door Latch-----door latch & strikers CANNOT be used to adjust door fitment**  
 See next page on NEW style 47-51 and 51-55 door latch kits

			<u>Year</u>	<u>New</u>	<u>Used</u>
12-208-L	new improved	left	47-51	\$79.95	
12-208-R	new improved	right	47-51	\$79.95	
12-208-1L		left	52-55	\$76.95	
12-208-1R		right	52-55	\$76.95	

The easy latch kit is a vehicle specific bolt-on, bear jaw rotary claw latch kit. This kit features contoured jam plates to match the features of your vehicles doors. These are in no way a universal application. The bear jaw rotary claw latches are each designed to work with the exterior handles, interior handles, and the exterior door lock cylinders of the specified vehicles. Each piece of the bear jaw latches are zinc plated to fight corrosion. The internal claws are case hardened and black oxide coated. Each kit comes with everything you need for two doors. Latch plates, vehicle specific bear jaw rotary claw latches, templates, hardware, detailed instructions, striker plates, and even stainless steel striker bolts. The Easy Latch kit will have your doors opening and closing smoothly and safely. All of the kits are designed, manufactured, and assembled here in the US. Most of our Altman Easy Latch Kits jam plates are available in your choice of paint to match steel or mirror polished stainless steel.

47-51 doors do not have a OE lock on the drivers side-the Altman latch allows you to lock w/ inner door handle- a new lock must be installed on the left door if you want it to lock like the pass side-----handles NOT included

### Easy Latch kit

12-2EL-47	uses OE w/ turn down handles		47-51	\$519.95	
12-2EL-47S	w/ shaved door handles		47-51	\$399.95	
12-2EL-52	w/ OE w/push button handles-pair		52-55	\$519.95	
12-2EL-52S	w/ shaved door handles		52-55	\$349.95	

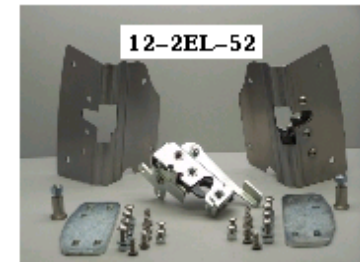







*Bill's Truck Shop*

Phone (905) 725-3460 / (905) 725-2022 / (905) 404-2302

# Door Rear-Panel-Suburban

Due to the fluctuation of the Canadian and American dollars call for current prices

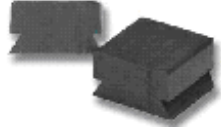
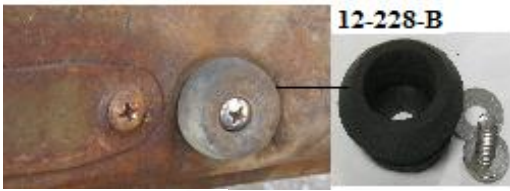
Group 12

		<u>Year</u>	<u>New</u>	<u>Used</u>
 <p>12-220-5K</p>	 <p>12-223-U 13-0223-S</p>			
 <p>12-205-1R</p>	 <p>12-205-1G</p>			
 <p>1-0207-B</p>				
	<p><b>Door Lock Retainer –Panel/Suburban</b> 12-205-1R U-clip in door end to secure lock in door</p>	47-55	\$12.95	
	<p><b>Door Lock Gasket</b> 12-205-1G pickup front right and 47-55 rear door on panel and suburban</p>	42-55	\$1.95	
	<p><b>Spring-rear door latch spring New # 12-0223-S</b> 12-0223-S use on up or lower each</p>	47-59	\$3.95	
	<p><b>Rear Door Control Rod</b> 12-224-R rod 24" long up &amp; lower each</p>	47-55	\$24.95	
 <p>12-228-B</p>				
 <p>12-205-PS</p>				
	<p><b>Door Bumper includes hdw</b> 12-228-B left door lower-replacement</p>	47-55	\$9.95	
	<p>12-205-PS rear barn door panel/suburb-base is tapered to match door location-front turn down handle can be modified to replace rear door handle</p>	47-55	\$47.95	

*Bill's Truck Shop*

Phone (905) 725-3460 / (905) 725-2022 / (905) 404-2302

# Door-Window

Due to the fluctuation of the Canadian and American dollars call for current prices

Group 13

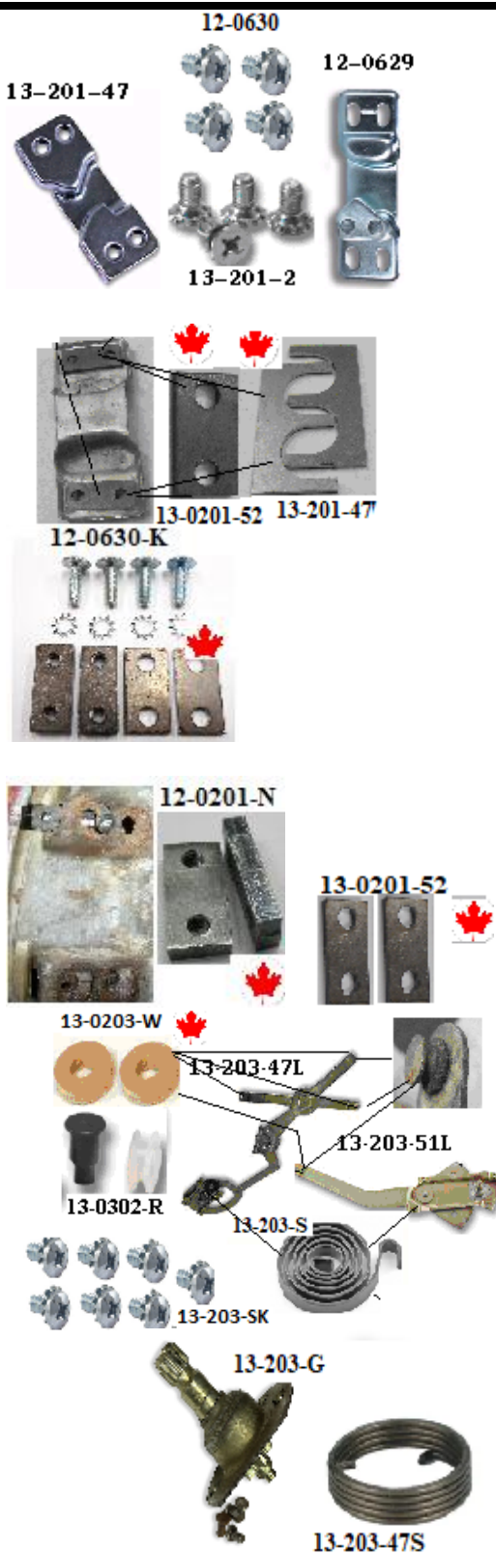

		<u>Year</u>	<u>New</u>
<b>Door Striker</b> mounts on door jamb (each)			
13-201-47L	left-while stock lasts	47-51	\$14.95
13-201-47R	right -while stock lasts	47-51	\$14.95
13-201-47P	<b>sold as pair only -</b>	47-51	\$34.95
12-0629-PR	<b>sold as pair only</b>	52-63	\$12.95
12-0629-R	fits panel / suburban with rear barn doors	52-63	\$14.95
<b>Door Striker Screw Kit</b>			
13-201-2	( ¼ NC ) (4) per side	47-51	\$3.00
12-0630	screws w/ washers (4) per side	52-63	\$2.95
<b>Door Striker Nut Plate</b>			
12-0201-N	threaded plate in backside of "B" pillar for striker screws ( ¼ NC ) pr	47-57	\$12.95
<b>Door Striker Shims</b> top & bottom for tsriker adjust			
13-201-47	0.064" thick pr	47-51	\$3.80
13-0201-52	1/8 x 1 7/16 long x ¾ wide pr	52-63	\$12.95
<b>Door Striker Hdw kit</b>			
12-0630-K	4 x ¼-20 NC Philips drive screws w/ washer,,shims & nut plates 1 side	52-early 57	\$19.95
<b>Window Regulator-new 47-55 regulators have the stud/roller combo(13-0302-R) NOT stud w/ leather washer</b>			
13-203-47L	left	47-50	\$109.95
13-203-47R	right	47-50	\$109.95
13-203-51L	left	51-55	\$99.95
13-203-51R	right	51-55	\$99.95
<b>Window Regulator Screw kit</b>			
13-203-SK	7 screws w/external tooth washer	47-51	\$3.95
13-0203-SK	4 screws w/ external tooth washers	52-72	\$3.45
<b>Window Regulator Rollers-47-55 had a solid pin for the roller- w 2 leather washers on each stud- can be replaced w/ 55-63 type w/ nylon wheel</b>			
13-0302-R	roller & pin	55-63	\$6.25
<b>Window Regulator Washer-leather washer on stud to guide &amp; stop vibration- 1 per stud-applies to OE regulators only w/o nylon rollers-if your stud is worn-place in vice and turn ½ locates flat spot in different position</b>			
13-0203-W	pair	36-55	\$2.50
<b>Window Regulator Gear Assembly w/ rivets</b>			
13-203-G		47-50	\$59.95
<b>Spring-Window Regulator Gear-inside gear assembly</b>			
13-203-47S	fits L or R	47-50	\$7.95

*Bill's Truck Shop*

Phone (905) 725-3460 / (905) 725-2022 / (905) 404-2302

# Door-Window

Due to the fluctuation of the Canadian and American dollars call for current prices

Group 13



			<u>Year</u>	<u>New</u>
<b>Door Trim-OUTER</b>				
13-206-L	painted	left	47-55	\$89.95
13-206-R	painted	right	47-55	\$89.95
13-206-SS	stainless steel	pair	47-55	\$349.95
<b>Outer Door Trim-screw kit –both sides</b>				
13-206-SK	8 pcs		47-55	\$7.95
13-207-L	painted	left	47-50	\$144.95
13-207-R	painted	right	47-50	\$144.95
<b>Door Glass Trim Screw set-inner</b>				
13-207	16 pcs		47-55	\$5.95
<b>Door Glass Frame Screws (barrel nut &amp; screw)</b>				
13-0208	each	pair	47-63	\$1.50
13-211-51 sash w/ roller guide 17" long left or right – each				
Can also be used when installing no vent window glass w/o frame---- caution- center glass on sash so roller does not extend past guide				
			51-55	\$61.95
<b>Door Glass Roller Guide -19" long used when installing once pc 47-50 glass in 51-55 w/ 51-55 window regulator----- also used on 47-50 original application- cut to fit/drill holes</b>				
13-211-19	require mount holes to be drilled	each		\$44.95
<b>Guide Screw kit-roller guide to sash</b>				
13-211-47SK	8 screws w external tooth washer	2 doors	47-50	\$6.95

*Bill's Truck Shop*

Phone (905) 725-3460 / (905) 725-2022 / (905) 404-2302

# Door-Window

Due to the fluctuation of the Canadian and American dollars call for current prices

Group 13

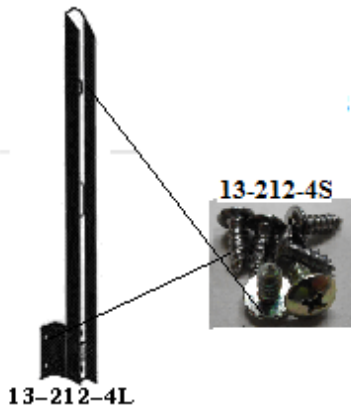
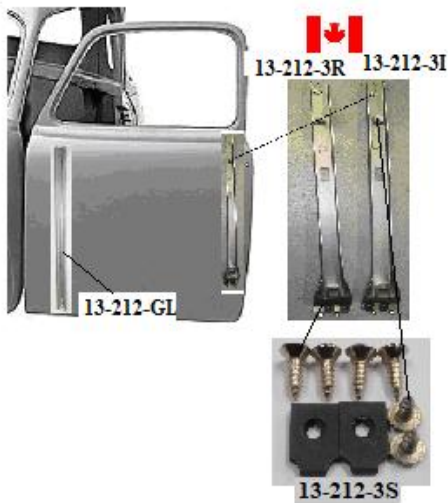

12-0205-K

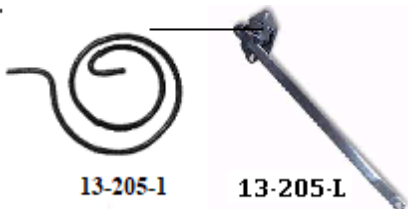

## Door Glass Guide Channel-vertical guide below handle -47-50 w/ out vent window-51-55 w/ vent window

				<u>Year</u>	<u>New</u>	<u>Used</u>
13-212-3L	rear	left	w/ hdw	47-50	\$39.95	
13-212-3R	rear	right	w/hdw	47-50	\$39.95	
13-212-4L	rear	left	w/hdw	51-55	\$32.95	
13-212-4R	rear	right	w/hdw	51-55	\$32.95	

## Screws-Vertical Door Glass Channel @ door edge

13-212-3S	counter sunk/Philips drive	w/o vent window	10 pcs	both sides	47-50	\$4.25
13-212-4S	pan head/Philips drive-w	/vent window	6 pcs	both sides	51-55	\$1.95

## Door Control

13-205-L	left	47-55	\$49.95
13-205-R	right	47-55	\$49.95

## Door Control Hdw kit -both sides

12-0205-K	6(zinc) screws w/ tooth washer-Philips drive	47-72	\$2.95
-----------	----------------------------------------------	-------	--------

## Door Control Spring

13-205-1	fits L or R-correct sagging handles	47-55	\$15.95
----------	-------------------------------------	-------	---------

*Bill's Truck Shop*

Phone (905) 725-3460 / (905) 725-2022 / (905) 404-2302

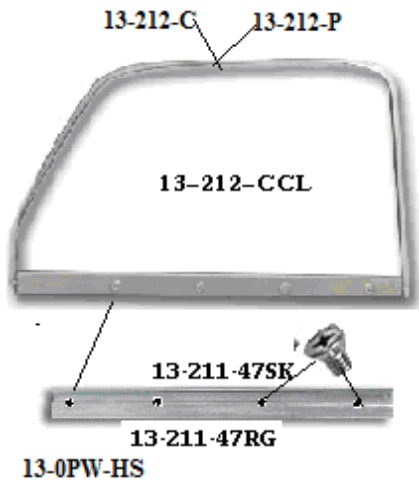

**Door Glass Frame Assembly --do not include roller guide**

			<u>Year</u>	<u>New</u>
13-212-CCL	chrome frame w/ clear glass	left	47-50	\$289.95
13-212-CCR	chrome frame w/ clear glass	right	47-50	\$289.95
13-212-BCL	black frame w/ clear glass	left	47-50	\$289.95
13-212-BCR	black frame w/ clear glass	right	47-50	\$289.95

**NOTE**-requires 7 ft per frame of glass setting tape #1-0GST-1-----1/12 W x 0.047 thick



**Door Glass Roller Guide** -19" long used when installing once pc 47-50 glass in 51-55 w/ 51-55 window regulator----- also used on 47-50 original application- cut to fit/drill holes

13-211-19	require mount holes to be drilled	each		\$44.95
-----------	-----------------------------------	------	--	---------

**Guide Screw kit-roller guide to sash**

13-211-47SK	8 screws w external tooth washer	2 doors	47-50	\$6.95
-------------	----------------------------------	---------	-------	--------



**Power Windows**- includes chrome switches, wiring harness, US made Sieman motors on original style window regulators w/ complete instructions- Brass iolite thrust bearings at pivots-----CALL FOR MORE INFO

13-247-PW	doors w/o vent windows	w/ door switches	47-50	\$984.95
13-251-PW	doors w/ vent windows	w/door switches	51-55	\$999.95

To switch to crank handle switches-add cost below

**Crank Handle Switches**

13-0PW-HS	check shaft length	pair	40-72	\$225.00
-----------	--------------------	------	-------	----------

**Bill's Truck Shop**

Phone (905) 725-3460 / (905) 725-2022 /(905) 404-2302

# Door-Window

Due to the fluctuation of the Canadian and American dollars call for current prices

Group 13

13-214-LBT



13-0213-S



13-213-HK

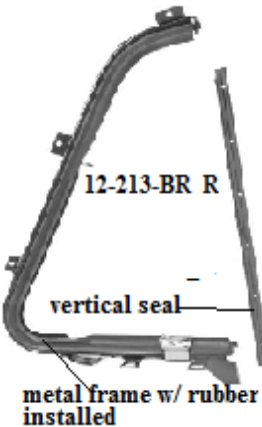

12-213-BR R

vertical seal

metal frame w/ rubber installed

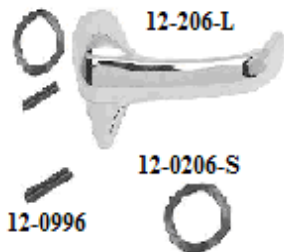

12-206-L

12-0206-S

12-0996

## Inquire about used vent window

13-214-LB black post/chrome glass frame w/ clear glass-left  
NEW PRODUCT!!  
13-214-RB black post /chrome glass frame w-clear glass-right

13-214-LCC stainless post/chrome vent frame w/ clear glass-left  
13-214-RCC stainless post/chrome vent frame w/ clear glass-right  
13-214-LCT stainless post/chrome vent frame w/ tinted glass-left  
13-214-RCT stainless post/chrome vent frame w/ tinted glass-right

Vent Window install hardware kit

13-213-HK 9 pcs per side

**Vent Handle Kit** Chrome plated with pin and washer

12-206-L left  
12-206-R right

**Vent Frame w/ weather stripping--outer frame only**  
re-use vertical post--requires vent assembly kit #1-0VHK-64

13-213-BR-L left side  
13-213-BR-R right side

Vent Window Frame Tension Spring

**13-0213-S** each 51-91 \$11.95

Vent Handle Tension Spring/Washer

**12-0206-S** each 51-72 \$0.60

Vent Handle Roll Pin

**12-0996** each 51-72 \$0.30

Year

New

51-55 \$569.95

51-55 \$569.95

51-55 \$579.95

51-55 \$599.95

51-55 \$599.95

51-55 \$599.95

51-55 \$599.95

51-55 \$5.95

51-55 \$19.95

51-55 \$19.95

51-55 \$199.95

51-55 \$199.95

51-91 \$11.95

51-72 \$0.60

51-72 \$0.30

*Bill's Truck Shop*

Phone (905) 725-3460 / (905) 725-2022 / (905) 404-2302

# Fuel System

Due to the fluctuation of the Canadian and American dollars call for current prices

Group 14

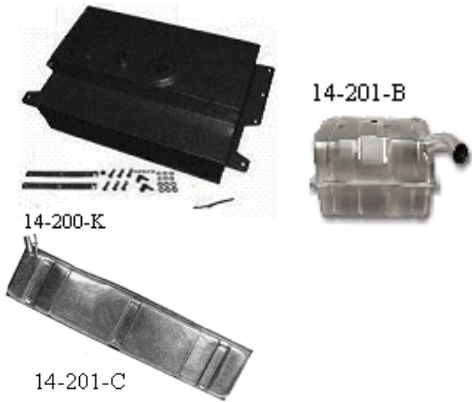

		<u>Year</u>	<u>New</u>
<b>Note - original fuel sender are 0- 30 ohm</b>			
<b>Gas Tank kit</b> 19 gallons-top right of centre fill-rear frame mount w/ hdw internal baffles ,zinc plated, silver painted-center front sender-side mount bkts middle of tank			
<b>-does not include fuel sender</b>		47-53	\$125.00
14-200-K	36" L x 14" W x 11" D	47-53	\$599.95
14-200-54-K	36" L x 14" W x 11" D	54-55	\$599.95
<b>Gas Tank</b>			
14-201-B 47-48 under bed- 1/2-3/4 pickups and 47-55 panel/suburban 13.5 gal-----these fuel tanks will also fit in 1 ton and up trucks w/ the larger fuel tank( minor modification may be required )-use the 14-201-2 supports			
14-201-C	in cab	49-55	\$344.95
<b>Tank support w/ straps</b>			
14-201-3	in cab	49-55	\$194.95
<b>Gas Tank Insulator kit</b>			
14-0GTP	2" x 40 " pair	47-66	\$9.95
<b>Gas Tank to Cab Bumpers</b> -back of gas tank to cab			
14-201-5	set of 3	49-55	\$7.95
14-201-5E	each	49-55	\$2.75
<b>Gas Tank Drain Floor Seal</b>			
14-0305	tank drain/fuel line	49-59	\$4.95
<b>Gas Tank Bracket w/ straps kit</b>			
14-201-2	47-48 pickup & 47-55 panel /suburban	47-55	\$199.95
14-201-2S	straps only set for above pair	47-55	\$89.95

*Bill's Truck Shop*

Phone (905) 725-3460 / 725-2022 / Fax (905) 404-2302

# Fuel System

Due to the fluctuation of the Canadian and American dollars call for current prices

Group 14



14-201-5



14-202 14-202-1 14-0202-5



14-202-3 14-202-2 14-202-4



14-0212 14-0305 14-0425

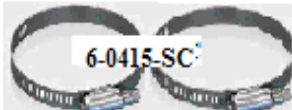

6-0415-SC



14-0212-C

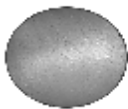

14-20GD



## Gas Tank to Cab Bumpers –back of gas tank to cab

14-201-5	set of 3	49-55	\$7.95
14-201-5E	each	49-55	\$2.75

## Gas Tank Drain Floor Seal

14-0305	tank drain/fuel line	49-59	\$4.95
---------	----------------------	-------	--------

## Gas Tank Filler Neck Grommet

14-202-2	on bed side	47-48	\$18.95
14-202-3	on cab	49-55	\$9.95
14-202-4	panel/suburban	47-55	\$9.95

## Gas Tank Filler Neck Pipe

14-202	correct curved 2 ¼ x11”pipe- pickup bed	47-48	\$39.95
14-202-PS	panel-suburban ½ ton	47-55	\$44.95
14-202-1	pickup truck w/ tank in cab <b>kit</b> -grommet, hoses w/ clamps & pipe	49-55	\$106.95

## Gas Tank Filler & Vent Hose

14-0202-5	2 ¼ x 6 “ long 47-48 pickup and 47-55 panel/surburban -located in right bed side	47-55	\$21.95
14-0212	pair pickup	49-59	\$21.95

## Gas Tank Filler Hose Clamp (4)

14-0212-C	correct OE style 4pcs	49-59	\$12.95
14-0212-S	crew type hose clamps 4 pcs	49-59	\$8.25
6-0415-SC	2 ½ screw type hose clamps-pr	47-48 & 47-55	\$3.75

## Fuel Line Grommet (thru floor) OD 1” / I.D. 3/8”

6-0510-GS	when using sender 14 -304 on 49-53 trucks	49-71	\$4.95
-----------	-------------------------------------------	-------	--------

## Fuel Fill Delete Plate

14-20GD	weld in-when removing tank from cab	48-54	\$23.95
---------	-------------------------------------	-------	---------

*Bill's Truck Shop*

Phone (905) 725-3460 / (905) 725-2022 (905) 404-2302

# Fuel System

Due to the fluctuation of the Canadian and American dollars call for current prices

Group 14

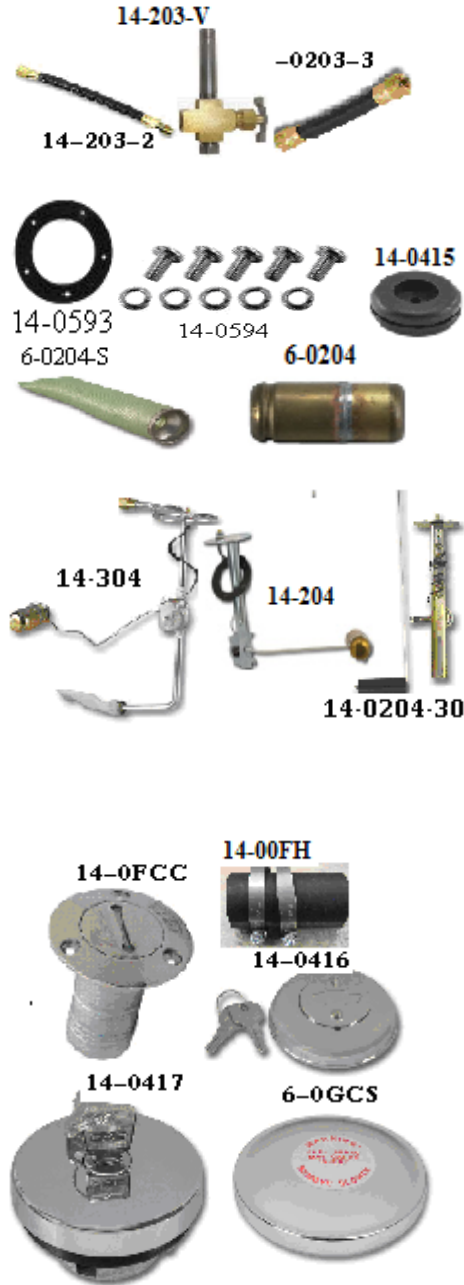

	<u>Year</u>	<u>New</u>
<b>Flexible Fuel Line (under tank)</b>		
14-203-2	49-53	\$32.95
14-0203-3	54-59	\$31.95
<b>Fuel Shut-off Valve</b>		
14-203-V @ tank outlet pipe to hose	49--53	\$64.95
14-0310 2" pipe( 1/8) w/ elbow w/ no valve used		
<b>Gas Tank Sender Wire Grommet</b>		
14-0415 on floor	36-59	\$2.95
<b>Gas Tank Sender Unit</b>		
14-204 without fuel pickup w/ gasket -will also fit		
47-49 under bed tank gravity fed 30 ohm	47-55	\$69.95
14-304 OE is 0- 30 ohm with fuel pickup	54-59	\$64.95
14-0204-90 universal application-90 ohm	47-59	\$64.95
14-0204-30 universal application-30 ohm	31-59	\$64.95
<b>Gas Tank Sender Unit Gasket</b>		
14-0593	47-66	\$2.95
<b>Gas Tank Sender Screw Kit</b>		
14-0594 6 pcs	47-66	\$2.95
<b>Gas Tank Sender Float</b>		
6-0204 brass	47-72	\$11.95
<b>Fuel Sender Pickup Screen</b>		
6-0204-S OE metal type for 5/16 line	54-72	\$28.95
<b>Gas Cap – Original Type- vented</b>		
6-0GCS stainless steel NEW PRICE!!	47-70	\$8.95
6-0GCP paint to match	47-70	\$27.00
<b>Locking Gas Cap---non vented</b>		
14-0416 w/ bowtie cover	47-70	\$74.95
14-0417 chrome -smooth w/2 keys	47-70	\$22.95
<b>Cool Cap-flush mount, billet aluminum, screw cap w/ 1 1/2 fill neck,3 " flange NON venting</b>		
14-0FCC		\$104.95
14-00FH fuel hose- neoprene 4" long x 1 1/2 ID w/ clamps		\$165.95

*Bill's Truck Shop*

Phone (905) 725-3460 / (905) 725-2022 / (905) 404-2302

# Glass - Trim

Due to the fluctuation of the Canadian and American dollars call for current prices

Group 15

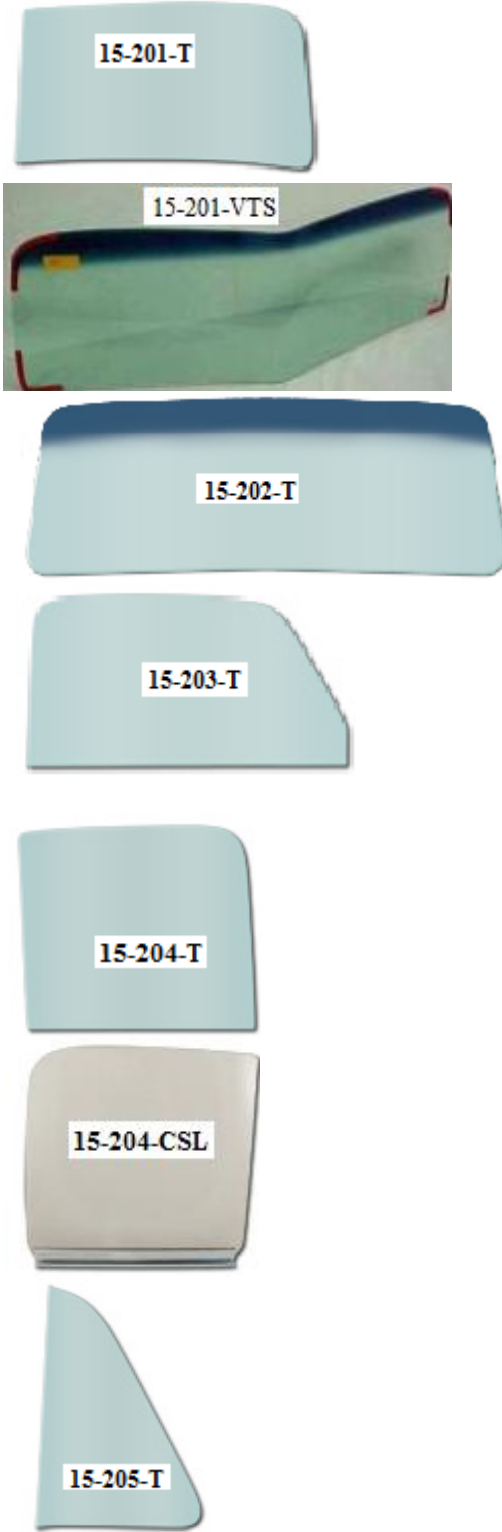

*-Front glass is laminated / side and rear glass are tempered*

			<u>Year</u>	<u>New</u>
<b>Windshield</b> (47-53) 2 piece / (54-55) 1 piece				
15-201-VTS	1 pc V-bent design-green tint w/shade top—windshield includes seal --will not accept stainless trim		47-53	\$599.95
15-201-C	left or right / clear	each	47-53	\$99.95
15-201-T	left or right / green tint	each	47-53	\$119.95
15-202-C	clear		54-55	\$359.95
15-202-T	tinted only		54-55	\$359.95
15-202-TS	tinted w/ upper shaded band		54-55	\$359.95
<b>Door 15-202-T Glass</b>				
15-203-C	clear	each	47-50	\$53.95
15-203-T	green tint	each	47-50	\$59.95
15-203-G	smoked grey		47-50	\$79.95
each			47-50	\$79.95
15-204-C	clear	each	51-55	\$64.95
15-204-T	green tint	each	51-55	\$74.95
15-204-G	smoked gray	each	51-55	\$79.95
<b>Door Glass w/ Sash</b>				
15-204-CSL	left- clear		51-55	\$224.95
15-204-CSR	right- clear		51-55	\$224.95
<b>Vent Glass</b>				
15-205-C	clear L & R	each	51-55	\$54.95
15-205-T	green tint L & R	each	51-55	\$59.95
15-205-G	smoked grey L & R	each	51-55	\$49.95

**Uses 1-0GST-1 on vent glass install**

*Bill's Truck Shop*

Phone (905) 725-3460 / (905) 725-2022 (905) 404-2302

# Glass - Trim

Due to the fluctuation of the Canadian and American dollars call for current prices

Group 15

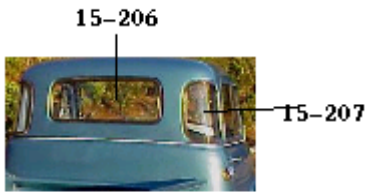

15-208



15-210

-Front glass is laminated / side and rear glass are tempered

Year

New

**Rear Glass**

15-206-C	clear	47-55	\$89.95
15-206-T	tinted	47-55	\$104.95
15-206-G	smoked grey	47-55	\$99.95

**Corner Glass**

15-207-CR	clear -R	47-55	\$79.95
15-207-CL	clear -L	47-55	\$79.95
15-207-TR	green tinted -R	47-55	\$89.95
15-207-TL	green tinted -L	47-55	\$89.95
15-207-SR	grey smoked glass-R	47-55	\$79.95
15-207-SL	grey smoked glass- L	47-55	\$79.95

**Glass Setting Tape** –rubber- for door and vent glass

1-0GST	0.062 thick-vent glass	per foot	\$3.95
1-0GST-1	thinner 0.047 thick	per foot	\$2.95

**NOTE- 1955 trucks are 1<sup>st</sup> series like 47-54 and 2<sup>nd</sup> series that are like 1955-59  
1947-53 have a 2 pc windshield and 1954-55 have a 1 pc windshield**

**Back Door Glass-Panel / Suburban**

15-208-CL	clear -Left	47-55	\$139.95
15-208-CR	clear-Right	47-55	\$139.95
15-208-TL	green tinted--L	47-55	\$149.95
15-208-TR	green tinted – R	47-55	\$149.95

**Back Hatch Glass-tempered Panel / Suburban**

15-210-C	clear	47-55	\$495.00
15-210-T	tinted	47-55	\$499.00

*Bill's Truck Shop*

Phone (905) 725-3460 / (905) 725-2022 / (905) 404-2302

# Windshield

When installing glass into the sash-do not seat to bottom when urethaning in

# Group 16



			<u>Year</u>	<u>New</u>
<b>Windshield Outer Center Moulding</b>				
15-215-SS	stainless steel		47-53	\$74.99
<b>Windshield Inner Post Trim</b>				
15-216-47	15-216-47	15-216-47	47-48	
15-216-P	15-216-P	15-216-P	47-53	\$39.95
<b>Windshield Inner Trim Post Retainers</b>				
15-216-R	15-216-R	15-216-R	47-53	\$12.95
<b>Windshield Inner Post Screw set</b>				
15-216-S	15-216-S	15-216-S	47-53	\$3.25
<b>Windshield Inner Trim w/ defrost vent outlet</b>				
15-220-L	15-220-L	15-220-L	47-53	\$174.95
15-220-R	15-220-R	15-220-R	47-53	\$174.95
<b>Windshield Inner Trim- locating clip</b>				
15-220-C	15-220-C	15-220-C	47-53	\$29.95
<b>Windshield Inner Trim Screw Kit</b>				
15-220-47	15-220-47	15-220-47	47-53	\$9.95
15-220-54	15-220-54	15-220-54	54-55	\$2.50
<b>Windshield Lower Moulding</b>				
15-225	15-225	15-225	54-55	
15-220-54	15-220-54	15-220-54	54-55	\$2.50
15-220-S	15-220-S	15-220-S	54-55	\$10.00
<b>Glass Setting Tape –rubber- for door and vent glass</b>				
1-0GST	1-0GST	1-0GST		\$3.95
1-0GST-1	1-0GST-1	1-0GST-1		\$3.95
<b>Windshield Moulding -outer</b>				
23-210-47	23-210-47	23-210-47	47-53	\$139.95
<b>Windshield Center Moulding-outer</b>				
15-215-SS	15-215-SS	15-215-SS	47-53	\$74.95

**Bill's Truck Shop**

Phone (905) 725-3460 / (905) 725-2022 / Fax (905) 404-2302 email: bill@billstruckshop.com

# Lighting

Due to the fluctuation of the Canadian and American dollars call for current prices

# Group 16

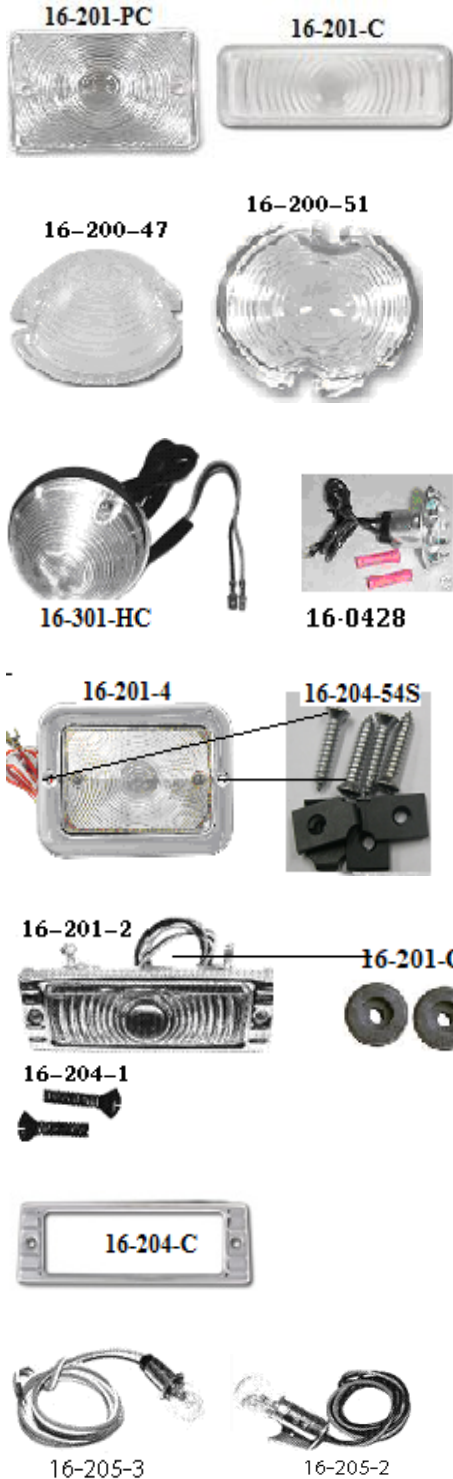

		<u>Year</u>	<u>New</u>	<u>Used</u>
<b>Park lamp Lens (each)</b>				
16-201-C	Chev-glass	47-53	\$11.95	
16-201-PA	Chev-GMC/amber	54-55	\$2.95	
16-201-PC	Chev-GMC/clear	54-55	\$9.95	
<b>Park lamp Housing Assembly w/lens &amp; wiring &amp; 12 volt bulb</b>				
16-201-2	w/ turn signals, <b>clear lens</b>	47-53	\$64.95	
16-201-2A	w turn signal <b>amber lens</b>	47-53	\$64.95	
16-201-2A-LED	LED w/ amber lens	47-53	\$129.95	
16-201-4B	Chev/GMC w/ out signals-clear lens	54-55	\$44.95	
16-201-4	Chev/GMC w/ turn signals-clear lens	54-55	\$99.95	
See 16-0428 for replacement socket				
<b>For a quick inexpensive solution on 47-53 GMC park lights-use 55-57 park/signal light assemblies w/ either clear or amber lens</b>				
16-301-HC	Chev/ with clear lens - each	55-57	\$49.95	
16-301-HA	Chev/ with amber lens - each	55-57	\$49.95	
<b>Park lamp Install kit</b>				
16-204-54S	housing to fender w/ u-nuts 8 pcs	54-55	\$6.95	
<b>Park lamp Harness Grommet</b>				
16-201-G	in rear of housing /Chev only pair	47-53	\$4.95	
<b>Park lamp Bezel (each)</b>				
16-204-C	Chev chrome each	47-53	\$17.95	
<b>Park lamp Lens Screw</b>				
16-201-LS-54	4 pcs stainless screw	54-55	\$2.95	
16-204-1	Chev pair	47-53	\$1.95	
<b>Front Park lamp / Turn Signal Kit-to add signals to original park lamp assemblies add 16-205-D6 when staying w/ 6 volt system</b>				
16-205-2	w/ 12 volt bulb each	47-53	\$11.95	
16-205-3	w/ 12 volt bulb each	54-55	\$10.95	

*Bill's Truck Shop*

Phone (905) 725-3460 / (905) 725-2022 / (905) 404-2302

# Lighting

Due to the fluctuation of the Canadian and American dollars call for current prices

Group 16

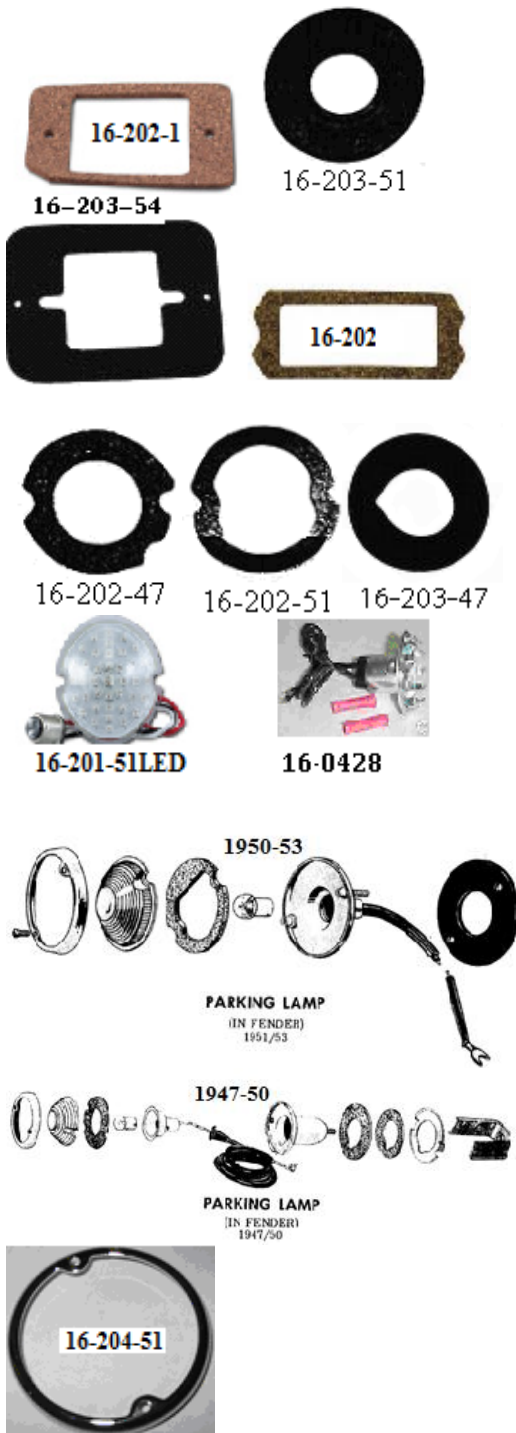

### Park lamp Lens Gasket (pair)

		<u>Year</u>	<u>New</u>
16-202	Chev	47-53	\$6.50
16-202-47	GMC-cork material	47-50	\$4.00
16-202-51	GMC-cork material	51-53	\$495
16-202-1	Chev-GMC	54-55	\$6.50

### Park lamp Housing to Fender Gasket (pair)

16-203-47	GMC	47-50	\$9.95
16-203-51	GMC (rubber)	51-55	\$14.95
16-203-54	GMC-Chev	54-55	\$16.95

### Socket-signal & brake

16-0428	2 wire for signal-brake & running light- accepts 2 pin off-set pin bulb	each	\$7.95
---------	-------------------------------------------------------------------------	------	--------

### Park lamp-LED 3 wire w/ park signal & ground

16-201-51LED	w/ clear lens-requires original housing & bezel to mount	51-53	\$79.95
--------------	----------------------------------------------------------	-------	---------

### Park lamp Lens

16-200-47	GMC glass w/ 2 3/8 lens	47-50	\$34.95
16-200-51	GMC glass w/ 2 11/16 lens	51-53	\$22.954

*Bill's Truck Shop*

Phone (905) 725-3460 / (905) 725-2022 / (905) 404-2302

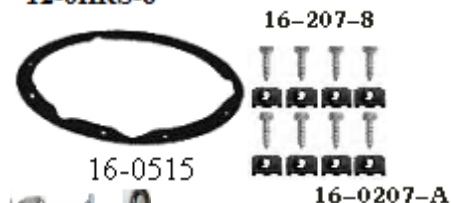
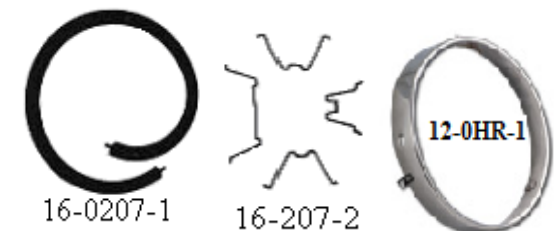
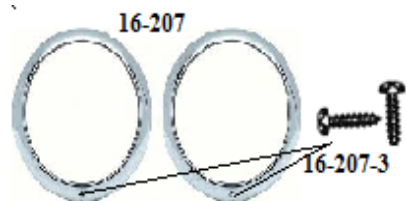
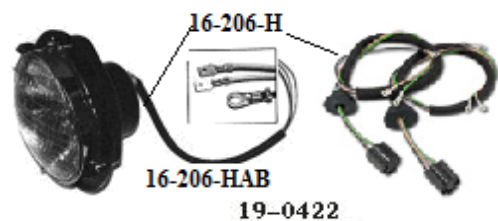

### Headlamps---

it is safe to use a Halogen 6006 (H6006) as long its watts rating is roughly the same (~40-50) Max amp draw on high beam: 8.2 and on low beam: 6.2

		<u>Year</u>	<u>New</u>
16-0206-6VH	6 volt Halogen		\$34.95
16-0206-12	12 volt Halogen		\$22.95

### Headlamp Assembly

16-206-HA	w/ universal harness w/out light	47-55	\$104.95
16-206-HAB	w/ OE style harness and 12 v bulb	47-55	\$183.95

### Headlight Pot

19-0422	Chev & GMC	L & R	each	41-55	\$44.95
---------	------------	-------	------	-------	---------

### Headlamp Harness w/grommets

16-206-H		pair	47-55	\$39.95
----------	--	------	-------	---------

### Socket-headlamp harness repair

16-0001	3 wire	each		\$4.50
---------	--------	------	--	--------

### Headlamp Rims stainless steel, w /screws, clips

16-207		pair	47-55	\$69.95
--------	--	------	-------	---------

### Headlamp Rim Seals- wire core as original

16-0207-1			47-57	\$23.95
-----------	--	--	-------	---------

### Headlamp Rim Seal Clips

16-207-2	4 pcs per light		47-55	\$5.95
----------	-----------------	--	-------	--------

### Headlamp Rim Screws

16-207-3	stainless steel	pair	47-55	\$0.80
----------	-----------------	------	-------	--------

### Headlamp Bulb Retainer Ring w/ screws

12-0HR-1		each	47-55 1 <sup>st</sup> and 62-72	\$19.95
----------	--	------	---------------------------------------	---------

### Headlamp Bulb Retainer Ring Screws (6)

12-0HRS-6				\$5.95
-----------	--	--	--	--------

### Headlamp Adjusting Screws and Nut

16-0207-A	1 screw w/ threaded nylon nut		47-57	\$4.95
-----------	-------------------------------	--	-------	--------

### Headlamp Adjuster Spring

16-0207-S	w/ mount screw	each	47-59	\$4.95
-----------	----------------	------	-------	--------

### Headlamp Bucket to Fender Gaskets

16-0515		pair	47-57	\$11.95
---------	--	------	-------	---------

### Headlamp Bucket to Fender Screws and J-Nuts

16-207-8	one side	(16 pcs)	47-55	\$10.95
----------	----------	----------	-------	---------

**Bill's Truck Shop**

Phone (905) 725-3460 / (905) 725-2022 / (905) 404-2302

# Lighting

Due to the fluctuation of the Canadian and American dollars call for current prices

Group 17



## Headlight Ring Support/Post

16-0208 secures to light pot lower w/ hdw each 47-57 \$8.95

## Headlamp Bucket Wire Grommets

17-0721 pair 37-57 \$5.95

## Headlight Wiring Inner Fender Grommet

17-0201 (OD-3/4-ID1/2) pair 47-early 56 \$3.95

## Headlamp Terminal Block mounts on inner fender.

17-202-3 3-pin 47-53 \$19.95

17-202-4 4-pin--- required when adding signals 47-55 \$21.95

## Taillamp Assembly with Wiring -w/ correct cloth wire & braided loom

---- Black w/ Chrome Bezel

17-203-LB black w/chrome bezel left 40-53 \$89.95

17-203-RB black w/chrome bezel right 40-53 \$89.95

17-203-2B black w/ stainless steel bezel 54-55 \$79.95

---- All Chrome

17-203-LC chrome housing left 40-53 \$94.95

17-203-RC chrome housing right 40-53 \$94.95

17-203-2SS stainless steel each 54-55 \$86.95

## Taillamp Assembly w/ LED lightning

17-203-LED-L stainless steel housing left 40-53 \$124.95

17-203-LED-R stainless steel housing right 40-53 \$124.95

17-203-LED-LC stainless steel w/ clear lens-red -R 40-53 \$124.95

17-203-LED-RC stainless steel w/ clear lens-red -L 40-53 \$124.95

17-0303-LED-S step side stainless steel housing w/wiring -each 54-59 \$104.95

17-0303-LED -P step side-black housing w/ wiring each 54-59 \$99.95

## Taillamp Lens (each)

----Pickup

17-204-GWD glass w/ blue dot installed 40-53 \$21.00

17-204-P plastic 40-53 \$8.95

17-204-1P plastic 54-55 \$5.95

## License Light Lens-in left taillight

18-201 plastic -for left taillight 40-53 \$3.95

## License Light Lens Gasket

18-201-G 40-53 \$1.95

## Tail Lamp Lens-Panel or Suburban

17-0204-D oval red w/rear barn doors 47-56 \$21.95

17-204-G -round red w/ clam shell doors 47-56 \$9.95

*Bill's Truck Shop*

Phone (905) 725-3460 / (905) 725-2022 / (905) 404-2302

# Lighting

Due to the fluctuation of the Canadian and American dollars call for current prices

Group 17

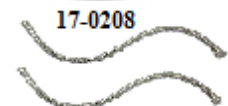

Tailamp Lens Gasket (pair)		Year	New
17-204-4	pickup	47-53	\$4.95
17-0204-5	step side pickup	54-59	\$4.50
17-0204-6	suburb / panel truck w/ barn door - oval lens	47-56	\$4.95

Tailamp Bezel (each)		Year	New
17-205	chrome pickup	47-53	\$8.95
17-205-1	chrome pickup	54-55	\$8.25
17-0205-2	suburb / panel truck w/ barn door - oval lens	47-56	\$33.95

Tailamp Wire Conduit / stainless steel		Year	New
17-0208	18 inches long pair		\$19.95
17-0208-12	12 inches long pair		\$15.95

**Bulbs** Signal or park. Single (S) or double (D) contact (each)

Bulbs		Year	New
16-205-DS6	6 volt-1pin/ 3 candle power-short w/ matching lock pin - ft signal & rear-signal brake-3 candle power		\$2.95
16-205-DS6-21	6 volt-1pin/ 3 candle power-short w/ matching lock pin - ft signal & rear-signal brake - 21 candle power		\$1.10
16-205-DT6	6 volt-1pin/21 candle power-tall w/ matching lock pin- front signal & rear brake lights		\$3.95
16-205-D6	6 volt-2 pin- 3 candle power-tall w/ offset lock pins		\$2.95
19-0179	3 CP 12 volts-when signals added to ft lights		\$1.75
19-0179A	amber / 3 CP 12 volts when signals added to ft lights		\$2.75
19-0176	clear 12 volt - double contact w/ parallel lock pins 21 candle power		\$5.50

LED BULB		Year	New
19-0650	single contact w/ parallel pins 12 V upgrade on 47-53 taillight assembly		\$11.95

Dash Bulbs		Year	New
18-0DB-6v	6 v single contact/level pins		\$1.95
18-0DB-12v	12 v single contact/ level pins		\$1.75

*Bill's Truck Shop*

Phone (905) 725-3460 / (905) 725-2022 / (905) 404-2302

# Lighting

Group 18

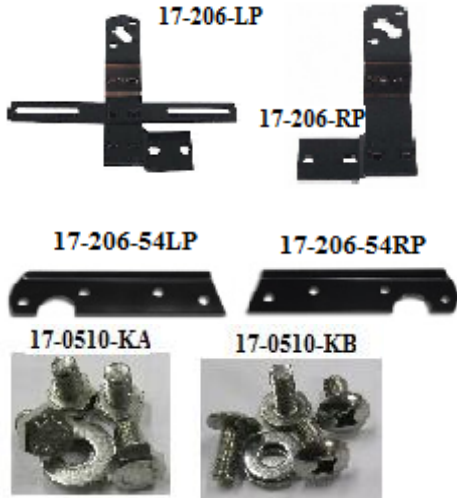

**Taillamp Bracket** 1947-53 Left w/ license bracket.  
Fit 1/2 - 3/4 ton trucks

**Painted**

		<u>Year</u>	<u>New</u>
17-206-LP	left	47-53	\$26.95
17-206-RP	right	47-53	\$20.95
17-206-54LP	left	54-55	\$10.95
17-206-54RP	right	54-55	\$10.95

**Chrome**

17-206-LC	left	47-53	\$42.95
17-206-RC	right	47-53	\$29.95
17-206-1LC	left	54-55	\$13.95
17-206-1RC	right	54-55	\$13.95

**Taillight Bkt Bolt kit**

17-0510-KA	Philips drive w/ washer & nut stainless steel 12 pc kit	47-72	\$7.95
17-0510-KB	7/16 hex head w/ washer 7 nut -stainless steel 12 pc kit	47-72	\$7.95

**NEW-** taillight brackets- use when installing roll pan w/ plate light----uses 2 x **right side** lights ( w/o plate light) installs on rear of stake pocket like OE -positions taillight closer to stake pocket and flush w/ tailgate---includes hdw-see picture below

17-207-P	paint to match	pair	47-53	\$32.95
17-207-S	brushed stainless	pair	47-53	\$44.95

## Bill's Truck Shop

Phone (905) 725-3460 / (905) 725-2022 / (905) 404-2302

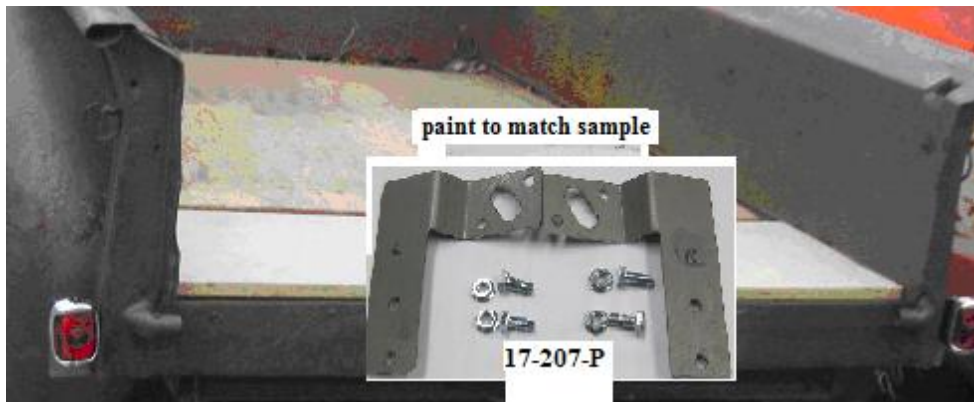

# Lighting

Group 18

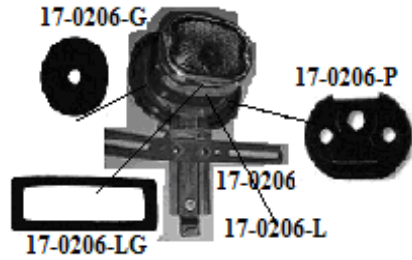
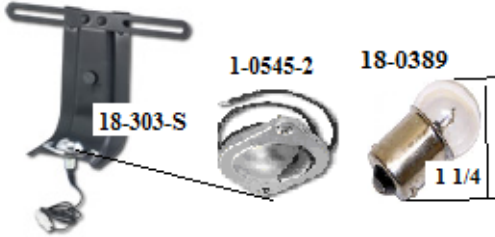

### License Plate Bracket & Lamp Assembly

		Year	New
18-303-S	step side plate bkt ass.	54-59	\$59.95
1-0545-2	replacement light assembly	54-72	\$16.95

<b>Taillamp Assembly w/ plate bracket</b> -mounts on left rear door on panel, suburban w side by side doors			
18-0389	bulb-plate light-single contact-level pins		
12V	6 CP	each	\$1.95
16-205-DS6	6 volt single contact 3 candle power	40-55	\$2.95

### Taillamp Assembly Mount Pad

		Year	New
17-0206-P	moulded rubber pad	47-56	\$69.95

### Taillamp Harness Grommet

		Year	New
17-0206-G	in door behind housing	47-56	\$2.50

### License Light Lens

		Year	New
17-0206-L		47-56	\$39.95

### License Lens Gasket

		Year	New
17-0206-LG		47-56	\$1.75

### Taillamp Lens--pan/surb w/ gate

		Year	New
17-0207-L	4 " plastic/round	34-55	\$24.95

### Taillamp Body Switch

		Year	New
17-0207-S	door & body contact switch-pr	37-55	\$89.95

### Fender-signal & park light (red & amber lens)

		Year	New
17-0567	roof & top of fender mount/big truck		\$26.95

### Hood Light Kit

		Year	New
	OE accessory kit		\$69.95

### Bullet Side Lights- original style brake-signal and running light on upper body on panel & suburban trucks-----OE accessory option

			Year	New
17-210	black	each	47-55	\$174.95
17-210-SS			47-55	\$159.95

*Bill's Truck Shop*

Phone (905) 725-3460 / (905) 725-2022 / (905) 404-2302

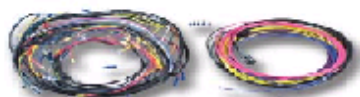

18-204-G



18-0588



18-0203



18-2481



18-0205-S

18-0205-OE

18-205-R

37-0315



18-0023-A



18-0987



19-0655-K

**Wiring Harness** - A complete harness to replace the original includes signals PCV coated, colour coded, numbered ends w/ instruction. **Gen** harness for OE charging system & **Alt** for internal regulator alt style  
*Great for stock trucks*

18-204-G	w/ generator	47-49	\$389.95
18-204-A	w/ alternator	47-49	\$389.95
18-204-1G	w/ generator	50-52	\$389.95
18-204-1A	w/ alternator	50-52	\$389.95
18-204-2G	w/ generator	53-55	\$389.95
18-204-2A	w/ alternator	53-55	\$389.95

**Custom Classic Updated Wiring Harness kit- by American Autowire --for the customized truck**

An excellent replacement updated wiring harness w/ blade type 18 fuse -21 circuit -includes plugs, switches for original or aftermarket gauges-HEI or point type dist harness- column connectors for stock or updated columns-front, rear & dome, under dash light harness-updates for original or AC updates, power windows, seats, stereo, electric fuel pumps etc-includes complete instructions, grommets, connectors, fuses, flasher extra wiring ties

18-2481		47-55	\$1349.95
---------	--	-------	-----------

**Fusible Link**

18-0588 9 " 12 gauge slow burn wire- fuse wire is usually 4 gauges smaller then circuit wire w/ connectors-excellent safety precaution installed to ignition feed wire at starter approx. 20-25 amps---add to starter-ignition dash feed

\$4.99

**Ignition Resistor**

18-0203 reduces ignition from 12v to 9v

47-59 \$29.95

**Wire Harness Clips**

18-205-R	@ upper rad support to right headlight 4 required	47-55	\$11.95
18-0205-S	for sheet metal/bulk wire each	47-59	\$1.95
18-0205-OE	original style for sheet metal	47-59	\$3.79

18-0205-F	at frame locations each	47-59	\$1.95
37-0315	insulated clamp style w/ hdw pair		\$3.75

**Fuse Holder-accessory**

18-0987	sealed w/ hdw & fuse- note fuse size		\$5.95
---------	--------------------------------------	--	--------

**ATO Spade Fuses**

18-0064	10 Amp ATO fuse-red		\$0.90
18-0066	20 Amp ATO fuse-yellow		\$0.90
18-0068	30 Amp ATO fuse-green		\$0.80

**Ground Strap Kit**

19-0655-K	5 pcs		\$39.95
-----------	-------	--	---------

*Bill's Truck Shop*

Phone (905) 725-3460 / (905) 725-2022 / (905) 404-2302



18-OWL-3

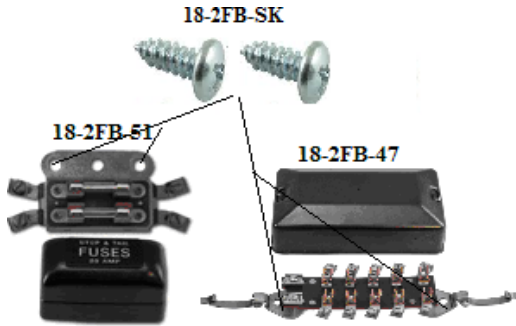

18-2FB-SK

18-2FB-51

18-2FB-47



15-0HL

18-0018



14-042-H

14-242-S



18-0209-6

18-0135



17-0045

**Wiring Loom** -seamless, black fabric ,heat resistant harness shield

18-OWL-1	1/4 in dia.	Per foot	\$1.95
18-OWL-3	3/8 in dia	Per foot	\$1.95
18-OWL-5	1/2 in dia	Per foot	\$1.95

**Wiring Conduit** –plastic,black,ribbed,split wiring covering

18-0WC-1	1/4 in dia	Per foot	\$1.19
18-0WC-3	3/8 in dia	Per foot	\$0.95
18-0WC-5	1/2 in dia	Per foot	\$1.15

**Fuse Box** – firewall mount w/ 2 or 5 fuse locations-complete OE used w/ Delco Remy logo

18-2FB-47	5 pin - H & L beam,park,tail,stop lights	47-50	
18-2FB-51	2 pin tail , stop lights	51-55	
18-2FB-SK	OE style mounting screws	pair 47-55	\$1.25

**Accessory Switch**-vintage style -under dash mount

17-0045	fused/rotary any acc lamps w/20 amp fuse-illuminated when on		\$24.95
---------	--------------------------------------------------------------	--	---------

**Under Hood Lamp**---early 1960 GM reproduction option

15-0HL		\$69.95
--------	--	---------

**Horn Button**-column mount

18-0018	6 or 12V application	\$9.95
---------	----------------------	--------

**Horn**

14-042-H	12v high tone-replacement	47-87	\$32.95
14-042-L	12v low tone-replacement	47-87	\$32.95

**Horn Support** on intake manifold

14-242-S	applies to OE horn	37-52	\$27.95
----------	--------------------	-------	---------

**Horn Relay**---most 6 volt horns draw up to 15Amps each

18-0209-6	6 volt only up 20 amp w/dual horn screw on terminals	41-56	\$59.95
18-0209	universal 6 or 12V w/ screw terminals Rated 14-18 amps @ 20 sec max	41-56	\$44.95
18-0135	universal 6 or 12 volt w/ push on terminal		\$24.95

*Bill's Truck Shop*

Phone (905) 725-3460 / (905) 725-2022 / (905) 404-2302

# Wiring-Switches

Due to the fluctuation of the Canadian and American dollars call for current prices

Group 18

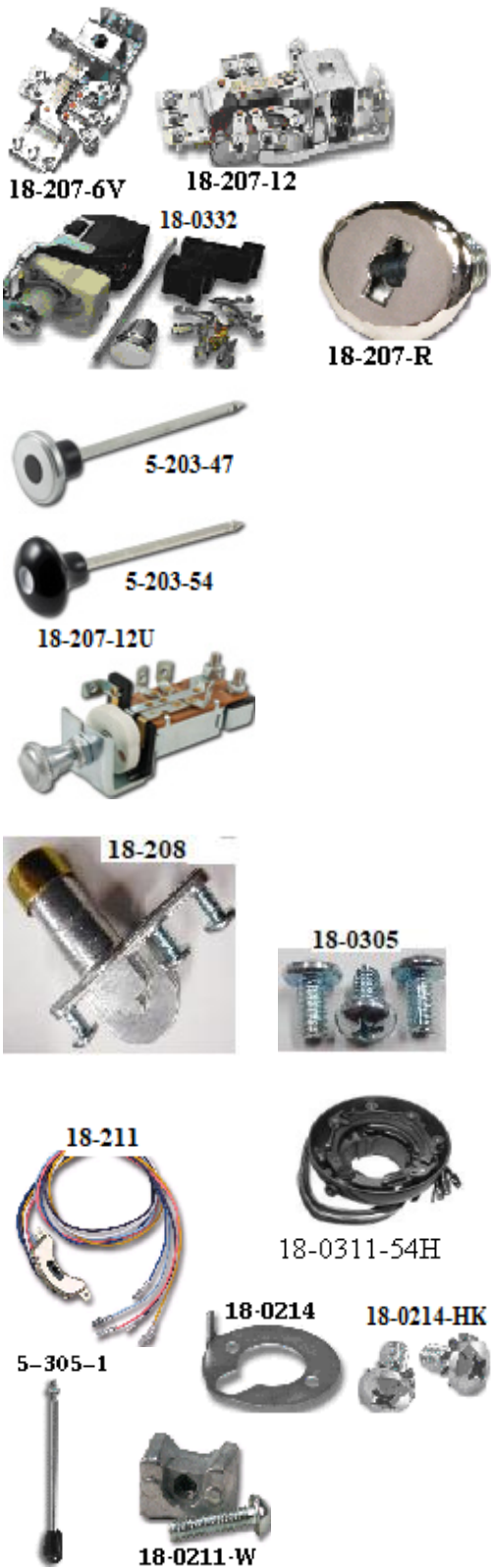

## Headlamp Switch

18-207-6	original style w/o fused dome& stop light circuit 6 volt w/ o rod-knob	47-55	\$88.95
18-207-6V	original style w/ fused dome& stop light circuit 6 volt w/o rod-knob	47-55	\$89.95
18-207-12	original style w/o fused dome& stop light circuit 12 volt w/ o rod-knob	47-55	\$99.95
18-207-12U	Headlight Switch-12V universal application w/rod & chrome knob screw on pins	47-59	\$37.95
18-0332	must be used when adding halogen lights to carry increased amp load -includes "D" shaped rod, aluminum knob and retainer	47-59	\$49.95

## Headlight Switch Retainer Nut

18-207-R	stainless steel	47-55	\$18.95
----------	-----------------	-------	---------

## Light Knob and Rod

5-203-47	stainless w/ maroon details	47-53	\$14.95
5-203-54	black w/ white center	54-55	\$13.95
5-204-54K	black knob only	54-55	\$5.95

## Dimmer Switch w/ screws

18-208		24-55	\$18.95
--------	--	-------	---------

## Dimmer switch -screw kit

18-0305	3 pcs	39-61	\$1.00
---------	-------	-------	--------

## Turn signal Switch

18-211	correct eye terminals in column bowl	54-55	\$36.95
--------	--------------------------------------	-------	---------

## Turn signal Housing Assembly w/ signal switch

18-0311-54H	Original cup style on column	54-56	\$199.95
-------------	------------------------------	-------	----------

## Turn Signal Lever

5-305-1		54-59	\$21.95
---------	--	-------	---------

## Turn signal Wedge w/ screw

18-0211-W		54-59	\$3.75
-----------	--	-------	--------

## Turn signal Cancel Plate

18-0214		54-59	\$5.60
18-0214-HK	2 screws w/ washers	54-66	\$1.25

*Bill's Truck Shop*

Phone (905) 725-3460 / (905) 725-2022 / (905) 404-2302



18-0551-U



18-213-P

18-0311



18-0213-F6

14-0SF-12



18-0213-F12-L2



18-0213-F12-L



18-0DB-12v

18-0PB-W



18-0DB-SN



18-0DB-W



18-0DB-S

18-0HB-12V



18-0010



18-0170-8



### Turn signal Switch Assembly

w/ brake lights control- With wiring diagram. Universal - comes w/6 indicator volt bulb -- use 3 pin flasher make sure switch has good ground to column

18-0551-U can be used on 6v or 12v

### Turn signal Flasher Plug and Harness w/Bkt

18-213-P 47-59 \$55.95

### Turn signal Flasher

18-0213-F6 6 volt 3 pin \$29.95

18-0213-F12-L 12 volt 3 pin-use w/ LED lights \$18.95

18-0213-F12-L2 12 volt 2 pin w/ ground wire use w/ LED lights \$26.95

18-0213-F12 12 volt 3 pin \$21.95

14-0SF-12 12 volt 2 pin \$6.95

14-0SF-12HD 12 volt HD electronic \$14.95

### Upper Column Bearing w/ Horn wire

18-0311 47-59 \$94.95

### Dash Bulbs

18-0HB-6v smaller 7/16 head for high beam indicator \$2.15

18-0DB-6v single contact/level pins \$1.95

18-0DB-12v single contact/ level pins \$1.75

### Socket-Dash Bulb

18-0DB-S USED OE metal socket w/ new harness 47-66 \$5.95

18-0DB-SN new plastic replacement socket w/ ,6" wire 47-66 \$5.95

**Wiring-Dash Bulb**--replaces dash bulb wiring when insulation is broken away using your original metal socket-reuse original steel socket

18-0DB-W replacement terminal w/ 8" wiring for OE steel sockets \$1.75

### Wiring-taillight/park w/ single pin

18-0PB-W -bulb # 63, 67, 81, 89, 93, 209, 1003, 1073, 1129,1133,1141,1156 \$3.50

### Fuses-barrel style 1 ¼ long

18-0003 3 amp \$0.99

18-0004 4 amp \$0.99

18-0005 5 amp \$0.99

18-0010 10 amp \$0.99

18-0015 15 amp \$0.99

18-0020 20 amp \$0.99

### Ground Strap-tin coated copper wire

18-0170-8 8" 11 gauge w/ 3/8 eyelets \$11.95

*Bill's Truck Shop*

Phone (905) 725-3460 / (905) 725-2022 / (905) 404-2302



### Ignition Switch-universal type

18-0579 new replacement when key start ( 4 position ) is required-direct fit into OE switch support w/ trim nut to secure-5 male spade terminals -uses key # 18-013 or 18-013-B 47-55 \$59.95

### Ignition Switch-

18-216-53 original style w/ foot start- mounts in switch support 47-53 \$59.95

18-216-54 original style w / foot start-mounts in switch support 54-55 \$69.95

### Ignition Switch Bezel—for 54-55 ignition switch

3-430-B a good replacement bezel from 64-66 chev truck 54-55 \$11.95

### Ignition Cylinder w/OE Style Keys

18-013 (double removal hole) 47-66 \$23.95

18-013-B extension allows for vehicle to be started w/o keys if not placed in lock position-also need keys to place in lock position- w/ 2 keys ( double removal hole ) 47-66 \$25.95

### Support-ignition switch

18-216-S bracket to mount OE style switch 47-53 \$28.95

### Push Button Start Switch

18-0TB2 dash mount push button start switch-w/ aut trans or electric start solenoid 15A@12V 5/8 shaft dia \$19.95

### Starter Switch -foot Start with side terminal

18-0202-ST with side terminal for 12V ignition 38-59 \$29.95

18-0202 w/ out side terminal w /6 volt 38-59 \$32.95

### Ignition Resistor

18-0203 reduces ignition from 12v to 9v 47-59 \$29.95

### Brake Light Switch

18-204 w/ screws 42-55 \$14.95

### Brake Switch Screw kit

18-0217 pair 42-59 \$1.00

### Cigarette Lighter Assembly w/o wire

18-210-53 w/ chrome knob 47-53 \$38.95

18-210-54 w/ black knob-white center 54-55 \$38.95

*Bill's Truck Shop*

Phone (905) 725-3460 / (905) 725-2022 / (905) 404-2302

# Mirrors

Due to the fluctuation of the Canadian and American dollars call for current prices

Group 20



		<u>Year</u>	<u>New</u>
<b>Outside Mirror Arm</b>			
<b>Painted</b>			
20-202-RP	right	47-55	\$39.95
20-202-LP	left	47-55	\$39.95
<b>Chrome</b>			
20-203-RC	right	47-55	\$49.95
20-203-LC	left	47-55	\$9.95
<b>Outside Mirror Arm Gasket w/ moulded lip</b>			
20-203-G		47-55	\$3.95
<b>Outside Mirror Arm Screw Set</b>			
20-203-S	Stainless Steel w/ hdw	pr 47-55	\$4.95
20-203-OE	collared style-Philips drive-steel	pr 47-55	\$5.00
<b>Outside Mirror Head</b>			
When setting the mirror head for viewing loosen the 3 set screws on back of head & tighten when in desired location-this prevents scratching the pivot ball and future rusting-also lube w/ grease			
20-0PM	round/ribbed/painted	47-70	\$19.95
20-0CM	round/ribbed/chrome	47-70	\$25.95
20-0PRM	rectangular/painted	47-70	\$24.95
20-0SRM	rectangular/stainless	47-70	\$29.95
<b>Peep Mirror Chrome Plated.</b>			
Mirror bracket, clamps on top edge of door.			
20-0PM-C	4 " w/ curved arm-chrome	L or R	\$39.95
9-0PM-S	4" w/straight arm-chrome	L or R	\$37.95
<b>Inside Mirror Head - Day/Night Chrome</b>			
20-206-DN		47-53	\$79.95
20-0206-DN		54-59	\$69.95
<b>Inside Mirror Head stainless steel</b>			
20-206	w/ correct 2 1/4 long post	47-53	\$59.95
20-0306	Stainless Steel	54-59	\$39.95
<b>Inside Mirror Bracket</b>			
20-207-SS	stainless steel	47-53	\$11.95
20-207-54	chrome-w/screws	54-55	\$33.95
<b>Big Truck Extension Mirror-black</b>			
20-0704	includes mount hdw		

*Bill's Truck Shop*

Phone (905) 725-3460 / (905) 725-2022 / (905) 404-2302

# Wiper

Due to the fluctuation of the Canadian and American dollars call for current prices

# Group 21

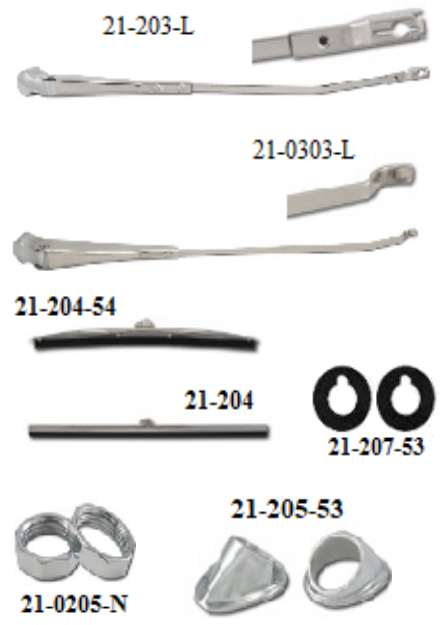

				<u>Year</u>	<u>New</u>
<b>Electric Wiper Motor</b> requires removing original bushing & grommet & installing new nylon bushing in kit with switch, wiring and instructions -USA made					
21-201-1	CHEV/GMC	12 volt		47-53	\$499.95
21-201-1-6V	CHEV/GMC	6 volt		47-53	\$349.95
21-201-3	CHEV/GMC	12 volt		54-55	\$479.95
21-201-3-6V	CHEV/GMC	6 volt		54-55	\$319.95
21-0200	pulse wiper control 3 speed w/ washer—accepts 5-304-B bezel			47-72	\$199.95
<b>Bushing kit w/ new electric wiper motor</b>					
21-0001	4 replacement nylon bushing w/ washers				\$7.95
<b>Wiper Switch—accepts 5-304-B trim bezel</b>					
21-0201-S	universal 2 speed switch w/o washers			47-58	\$19.95
<b>Wiper Switch Bezel</b>					
5-304-B	switch bezel when installing electric wipers				\$12.50
<b>Wiper Arm Stainless Steel (each)</b>					
21-203-L	original style	left		47-53	\$24.95
21-203-R	original style	right		47-53	\$24.95
21-203-1L	snap-in style	left		47-53	\$22.95
21-203-1R	snap-in style	right		47-53	\$21.95
21-0303-L		left		54-59	\$24.95
21-0303-R		right		54-59	\$24.95
<b>Wiper Blade (each)</b>					
21-204-8	original style	8 "		29-53	\$6.00
21-204-9	original style	9 "		47-53	\$6.00
21-204-10	original style	10"		47-53	\$5.95
21-204-10N	snap-in style	10 "		47-53	\$24.95
21-204-54	snap-in style	11"		54-55	\$22.95
<b>Wiper to Cowl Bezels - die-cast, chrome plated.</b>					
21-205-53		pair		47-53	\$19.95
21-205-54		pair		54-55	\$18.95
<b>Wiper Bezel Nuts</b>					
21-0205-N		pair		47-59	\$8.95
<b>Wiper to Cowl Bezel Gaskets</b>					
21-207-53		pair		47-53	\$4.50
21-207-54		pair		54-55	\$4.50

*Bill's Truck Shop*

Phone (905) 725-3460 / (905) 725-2022 / (905) 404-2302

# Wiper-Parts

Due to the fluctuation of the Canadian and American dollars call for current prices

# Group 21

5-204-47M 5-204-54C

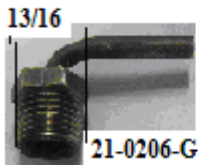

21-0206-VH



21-0206-H



21-0921



21-0936



21-0940

8-206

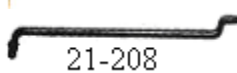

21-208



8-208-1

Year New

### Wiper Knob—will not fit new style electric switch

5-204-47C	chrome	47-53	\$12.95
5-204-47M	maroon	47-53	\$9.95
5-204-54C	Chev black	54-55	\$11.95
5-204-54G	GMC grey	54-55	\$7.75

### Wiper to Cowl Bezel Gaskets

21-207-53	pair	47-53	\$4.50
21-207-54	pair	54-55	\$4.50

### Wiper Control Gasket

21-206-53G		47-54	\$0.99
------------	--	-------	--------

### Vacuum Hose Firewall Grommet

8-206	11/16 hole dia	47-55	\$2.95
-------	----------------	-------	--------

### Vacuum Hose –vacuum wiper to engine outlet

21-0206-VH	3' 7/32 dia hose	47-59	\$3.25
------------	------------------	-------	--------

### Vac Outlet on Intake Manifold

21-0206-F	brass 90 deg ----3/8 OD	47-59	\$8.95
21-0206-G	brass 90 deg---- 13/16 OD		
21-0206-H	brass 90 deg---13/16 OD 2 pcs	47-59	\$14.50

### When adding a brake booster-requires 21-0936 & 21-0940 plus if using vac wipers 21-0921

21-0940	brass reducer		\$6.95
21-0936	brass elbow		\$7.95
21-0921	nylon "T" fitting 3/8 x3/8 & 1/4		\$2.50

### Wiper Control Link Rod

Between switch and wiper motor.

21-208		47-53	\$6.50
--------	--	-------	--------

### Wiper Control Link Grommets (pair)

21-208-1		47-55	3.50
----------	--	-------	------

*Bill's Truck Shop*

Phone (905) 725-3460 / (905) 725-2022 / (905) 404-2302

# Wiper-Parts

Due to the fluctuation of the Canadian and American dollars call for current prices

# Group 21



		<u>Year</u>	<u>New</u>	<u>Used</u>
<b>Wiper Transmission Arm Grommets</b>				
21-209	pair	47-53	\$3.50	
<b>Wiper Transmission Arm Retainer</b>				
Spring Retainer and Clips				
21-209-1		47-53	\$5.95	
21-0209-1		54-59	\$4.95	
<b>Wiper Transmission Arm and Pivot</b>				
21-210-47K	pair	47-53	\$199.95	
21-210-54K	pair	54-55	\$185.95	

*Bill's Truck Shop*

Phone (905) 725-3460 / (905) 725-2022 / (905) 404-2302



22-204



22-0204-S

22-0206-A



22-0206



22-0299



5-208-8



5-208-4

22-205-6



22-205-12V

22-205-OE



4-0211-ER



22-208

**2 year warranty-must use antifreeze- max 4 lb rad cap—must have rebuildable core- w/ charged gas bulb must**

**Heater Control Seal kit**

22-204-K	w-springs, clips & instructions	47-55	\$56.95
22-0204-S	seal only	47-63	\$22.95

**Heater Hose Water Shut-off Valve-manual**

22-0206	5/8 hose to 3/8 pipe	37-62	\$49.95
22-0206-A	5/8 in 5/8 out	37-62	\$39.95

**Throttle Cable w/ Knob –use this cable to control water valve (22-0209) -set w/ cable “IN” water flow closed**

5-208-8	stainless steel & maroon	47-53	\$32.95
5-208-4	black w/ white “T”	54-55	\$32.95

**Water Control Valve-control from inside the truck**

22-0299	heater hose-manual control water valve -pull to open 5/8 by 5/8 hose dia- can use cable 5-208-8 or 54 5-208-4 w ( T ) cable to control setting	47-87	\$42.95
---------	------------------------------------------------------------------------------------------------------------------------------------------------	-------	---------

**Heater Switch - Under dash Type Universal**

22-205-6	w/ lighted control ( black marking) 6 volt	47-55	\$34.95
22-205-12V	w/ lighted control 10 amp/ 12 V	47-59	\$44.95

**Voltage Reducer-for radio & heater motor**

4-0211-ER	1 ohm 50 watt metal encasement		\$13.95
-----------	--------------------------------	--	---------

**Heater Hose Grommets-in firewall**

22-208	w/ Deluxe /Fresh Air Heater	47-55	\$8.95
--------	-----------------------------	-------	--------

**Heater Hose**

Accel			
18-0401	5/8 black-per foot		\$3.95
18-0402	3/4 black-per foot		\$4.25

*Bill's Truck Shop*

Phone (905) 725-3460 / (905) 725-2022 / (905) 404-2302

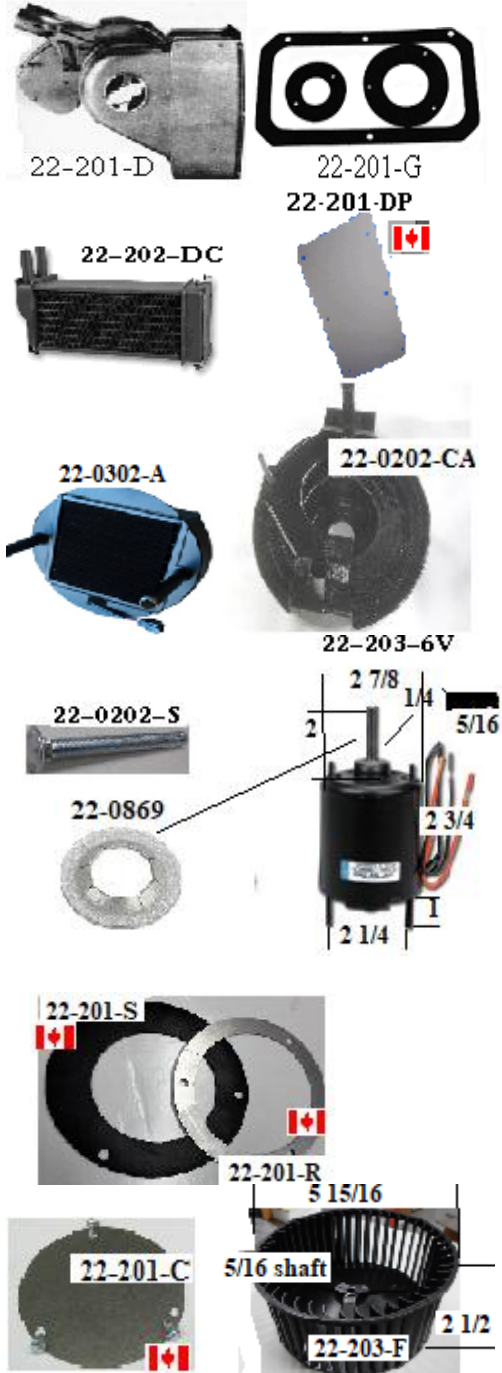

**Heater Housing Mount Bolt**-secures body to firewall

22-0202-S 1/4 x 2 "bolt w/ hdw 47-59 \$1.00

**Heater Housing Cover Plate w/hdw** 16GA galvanized

22-201-DP includes 6 1/4 x 1/2 Philips drive screws & washers 47-55 \$15.95

**Deluxe Heater Gasket Set**

22-201-G w/ Deluxe /Fresh Air Heater 47-55 \$17.95

**Heater Core**

22-202-DC - deluxe heater w/ 8Lx 4 1/2 H x 3 1/2 W w/end brackets- rectangular core **also called Deluxe/ Fresh Air Heater** ---does not fit 54-55 heater with recirculator option w/ the tall one inch wide vertical door. 47-53 \$419.95

**Heater Core Assembly w/ 12v motor**

22-0302-A replacement assembly w/ 12 V motor -new square core w/ round tanks- must install support from old assembly 47-57 \$449.95

**Heater Core Assembly (copper ) w/ 11/16 pipe outlets**

22-0202-CA round assembly- no motor 47-57 \$389.95

**Heater Motor-Standard or Deluxe**

22-203-6V 6 volt w/ round recirculating heater 2 way rotation 1/4 shaft w/ 5/16 sleeve adaptor 47-55 \$129.95

22-0759-12V 12 V motor for round style heater cores w/ 1/4 inch dia shaft-2 5/16 stud -3.75 body length- 2 way rotation **Recirculating Heater includes 5/16 shaft adapter sleeve** 47-59 \$149.95

22-0203-HM12 12 V motor for rectangular heater w/ 5/16 shaft -mount bolt spacing 2 5/16-----4.20 " body length 2 wire for rev or forward rotation all w/ **Deluxe/ Fresh air heaters** 47-66 \$109.95

**Heater Motor Fan**

22-203-F plastic replacement 47-55 \$29.95

**Retainer-fan-used to locate fan on shaft lower & secure upper**

22-0414 1/4 ID used on 1/4 motor shaft pair \$1.00

22-0869 5/16 ID used on 5/16 motor shaft pair \$1.00

**Heater Motor-Deluxe @ firewall**

22-201-R ring w/ screws 47-55 \$12.95

22-201-S neoprene seal for ring 47-55 \$4.95

22-201-C cover w/ std heater 47-55 \$12.95

**Bill's Truck Shop**

Phone (905) 725-3460 / (905) 725-2022 / (905) 404-2302

# Heater Parts

Due to the fluctuation of the Canadian and American dollars call for current prices

Group 22



**Heater Control Stands** supports for dlx heater control rod w/grommet & def cable

22-216-S	pair	47-55	\$32.95
----------	------	-------	---------

**Heater Control Rod Grommet**

22-216-G	in right temp control rod stand	47-55	\$1.95
----------	---------------------------------	-------	--------

**Fresh Air Door Cable**- controls the 1" vertical vent door from fresh air to recirculator - vertical door on heater box at kick panel -used on 1953 and 54-55 truck w/ correct looped end

5-208-8	Use throttle cable as replacement	47-53	\$32.95
---------	-----------------------------------	-------	---------

22-216-54	black knob w/white center	54-55	\$44.95
-----------	---------------------------	-------	---------

**Defroster Outlets**

22-210	replacement are plastic	each 47-53	\$33.95
--------	-------------------------	------------	---------

**Defroster Duct Hose-original cloth/wire type**

22-209	1.75 x 54"	47-53	\$54.95
--------	------------	-------	---------

22-209-P	plastic 1.75"	47-53	\$32.95
----------	---------------	-------	---------

22-0209	2" x40"	54-63	\$54.95
---------	---------	-------	---------

22-0209-P	plastic 2"	54-63	\$32.95
-----------	------------	-------	---------

**Manual Defroster Lever Decal**

22-0212	fresh air & recirculating heater	47-59	\$7.95
---------	----------------------------------	-------	--------

**Heater Mylar Decal** -Chev/red & blue on silver-- GMC red on silver-decal used on 53-55 heaters

22-213-1	Chev- w/ fresh air heater	53-53	\$3.75
----------	---------------------------	-------	--------

22-213-R	Chev- w/fresh air & recirculating heater	53-53	\$3.95
----------	------------------------------------------	-------	--------

22-213-G	GMC- w/ fresh or recirculating heater	53-55	\$10.95
----------	---------------------------------------	-------	---------

22-213-4F	Chev - w/ fresh air heater	54-55	\$5.75
-----------	----------------------------	-------	--------

22-213-4R	Chev - w/ recirculating heater	54-55	\$5.95
-----------	--------------------------------	-------	--------

**Heater ID Plate** Aluminium, 3" round.-used on earlier 47-52 heaters

22-214-C	Chev 3" red/blue on silver	47-52	\$49.95
----------	----------------------------	-------	---------

22-214-G	GMC 3" red/ silver	47-52	\$47.95
----------	--------------------	-------	---------

*Bill's Truck Shop*

Phone (905) 725-3460 / (905) 725-2022 / (905) 404-2302



22-215-M

**Heater Knobs – Warmer-water flow control knob**

22-216-53	stainless knob w/maroon center	53-53	\$49.95
22-216-54	black knob w/white center	54-55	\$44.95



22-0201

22-0058

**Heater Accessory Kit**

22-0201 a compact 12 volt replacement-includes switch & cable operated defrost -does not include hose & vents 5/8 pipe outlets- will accept 1 3/4 or 2" defrost hose on defrost outlets grommet # 22-208 requires 22-0058 adapters for firewall outlet

Year

New

22-0058	brass 5/8 outlets 90 deg pair		\$19.95
---------	-------------------------------	--	---------

**Heater Hose Grommets-in firewall**



22-208

22-208	w/ Deluxe /Fresh Air Heater	47-55	\$8.95
--------	-----------------------------	-------	--------

*Bill's Truck Shop*

*Phone (905) 725-3460 / (905) 725-2022 / (905) 404-2302*

# Emblems-Trim

Due to the fluctuation of the Canadian and American dollars call for current prices

Group 23



23-208-G



23-0727



23-205-GMC

23-202-G



23-202-G1



BTS exclusive  
made in USA



23-206-G



23-205-3



23-205-4



23-205-GMC

GMC\_GMC-GMC-GMC-GMC

Year

New

**Hood Side Emblem -Chrome w/hardware**

23-202-G	GMC white w/red details	pair	47-54	\$139.95
23-202-CG	GMC chrome w/red details	pair	47-54	\$189.95

**CANADA built truck emblems**

23-202-G1	100 GMC hood side emblem	each	47-55	\$45.95
-----------	--------------------------	------	-------	---------

**Accessory Hood Ornament**

23-205-GMC	chrome (special order )		47-55	\$649.95
------------	-------------------------	--	-------	----------

**Emblem Fastener kit**

23-0727	8 x 10-24x1 studs & 8 high dome nuts 16 ;pcs		47-59	\$14.95
---------	----------------------------------------------	--	-------	---------

**Hood Center Strip-mld may require adjusting to the hood contour before installing**

23-206-G	GMC stainless steel		47-54	\$99.95
----------	---------------------	--	-------	---------

**Accessory Hood Ornament**

23-205-3	chrome		47-53	\$214.95
23-205-4	Eagle/chrome - Chev		54-55	\$379.99

*Bill's Truck Shop*

Phone (905) 725-3460 / (905) 725-2022 / (905) 404-2302

# Emblems-Trim

Due to the fluctuation of the Canadian and American dollars call for current prices

Group 23



23-203-R/B



23-204-R



23-0727



23-206-C



23-0344

23-0345



CHEV_CHEV-CHEV-CHEV		Year	New
<b>Front Hood Emblem</b>			
With mounting hardware. Both fit all years.			
23-201-SS	Chev - stainless steel	50-53	\$139.95
23-201-CR	Chev - chrome	47-49	\$124.95
23-201-5	Chev - stainless steel NEW !!	54-55	\$394.95
<b>Hood Side Emblem -Chrome w/hardware</b>			
3100 are US model and 1300 are Canadian model			
23-202	CHEVROLET TRIFTMASTER pair	47-49	\$89.95
23-202-1	CHEVROLET pair	49-53	\$89.95
23-202-2	3100 pair	49-52	\$74.95
23-202-2/36	3600 USA each	47-51	\$89.95
23-202-2/38	3800 USA each	47-51	\$89.95
23-202-3	3100 pair	53-54	\$55.95
23-202-4	3100 / CHEVROLET-1 <sup>st</sup> series pair	55-55	\$165.95
23-202-5	1300 Canada model each	47-55	\$34.95

### Front Hood Emblem Mounting Gasket-Chev

23-202-47		47-53	\$6.95
23-202-54		54-55	\$6.25

### Front Hood Emblem Decals-Chev

23-203-RB	red and blue decals	47-53	\$19.95
-----------	---------------------	-------	---------

### Grill and Hood Emblem Decals-Chev

23-204-RB	red stripes w/ black letters	54-55	\$14.95
23-204-RW	red stripes w/ white letters	54-55	\$14.95
23-204-WB	white stripes w/ black letters	54-55	\$14.95
23-204-WW	white stripes w white letter	54-55	\$14.95

### Emblem Fastener kit- for threaded studs type only

23-0727	8 x 10-24x1 studs & 8 high dome nuts 16 :pcs	47-59	\$14.95
---------	----------------------------------------------	-------	---------

### Hood Center Strip- mld may require adjusting to the hood contour before installing

23-206-C	Chev stainless steel	47-54	\$149.95
23-206-SC	Chev steel	47-54	\$179.95
23-206-SC-5	Chev/steel -large truck-57" long	47-54	

### NAPCO

23-0344	Body emblem each	51-59	\$114.95
23-0345	shift pattern plate	54.59	\$39.95

Bill's Truck Shop

Phone (905) 725-3460 / (905) 725-2022 / (905) 404-2302

# Grills

Due to the fluctuation of the Canadian and American dollars call for current prices

# Group 24

24-201-CR



24-202-CG



24-201-S

24-201-C

24-202-C



24-201-MK

24-201-HK



24-201-2

**Chevy Grill 1/2-3/4 and 1 ton includes install hdw**

24-201-P	painted	47-53	\$795.95 \$1099.95
24-201-CR	chrome w/ cream back bars	47-53	
24-201-BR	chrome grille w/ black bars	47-53	\$1199.95
24-201-CC and supports	all chrome including back bars	47-53	\$1199.95
24-202-CG	chrome	54-55	\$2679.95

**Grill Hardware Assembly & install Kit**

24-201-HK	Chev	47-53	\$32.95
-----------	------	-------	---------

**Grill Install kit**

24-201-MK	Chev	bolts w/ j-nuts	47-53	\$11.95
24-202-MK	Chev	bolts w/ j-nuts	54-55	\$35.95

**Lower Valance Hdw kit**

24-201-2	j-nuts w/ screws 36 pcs-Chev	47-53	\$20.95
----------	------------------------------	-------	---------

**Grill Nose**

24-202-C	Chrome Plated	54-55	\$149.95
24-202-S	Steel	54-55	\$129.95

*Bill's Truck Shop*

Phone (905) 725-3460 / (905) 725-2022 / (905) 404-2302

24-203-CS



24-203-CR



24-203-54-C

24-203-LE



4 bars flush



3 bars recessed



**GMC**

**GMC Grill**

24-203-CR chrome w/ white back supports 49-53 \$1399.95

**Grill Surround- GMC**

24-203-CS chrome 47-53 \$699.95

24-203-PS painted 47-53 \$599.95

1947-early 1948 GMC trucks had the CAR style bumper w/ the heavier forward mounted GMC grille-included support bars through the inner fender to frame for extra grille support-frame was approx 8" longer at front to support the grille which bolted directly to the frame -bumper bks are completely different

*Bill's Truck Shop*

Phone (905) 725-3460 / (905) 725-2022 / (905) 404-2302

# Hubcaps

Due to the fluctuation of the Canadian and American dollars call for current prices

Group 24

24-205-4SB



24-0205-S



24-206-S-R



24-205-SR



24-007-15S



24-007-15R



24-0201-15



Hubcap		Year	New
<b>Smooth- Baby Moon style</b>			
24-0205-S	stainless steel/smooth---w/ clip styles wheels only	each	\$99.95
24-0205-8	chrome/smooth ---fit outside ear wheels only	10 1/8 OD chrome	\$36.95
<b>Chevy</b>			
24-205-SR	½ ton stainless steel w/ red details- each	47-53	\$99.95
24-205-2SR	¾ to 1 ton- chrome w/red details fit 15 to 17 “ split wheels –can be used on any clip wheels need to check dept of floating rear axle	each	46-53
24-205-4SB	stainless steel w/ blue details -each	54-55	\$84.95
<b>GMC Note can also use on 54/55</b>			
24-206-S-R	stainless steel w/ painted red details- each	46-53	\$99.95
24-206-S-W	stainless steel w/ painted white details-each	46-53	\$99.95
<b>Beauty Ring (stainless steel)</b>			
24-007-15S	15 inch w/ smooth face	each	47-72
24-007-15R	15-inch w/ ribbed face	each	47-72
24-007-16S	16 inch w/ smooth face	each	47-72
24-007-16R	16 inch w/ ribbed face	each	47-72
<b>Moon Hub Caps—Salt Flat style</b>			
24-0201-15	15 “ wheels	brushed stainless steel	each
			\$27.95

Bill's Truck Shop

Phone (905) 725-3460 / (905) 725-2022 / (905) 404-2302

# Wheels

Due to the fluctuation of the Canadian and American dollars call for current prices

Group 24



## Wheel Clips –includes hdw

Clips for retaining original type hubcaps. (Each)

24-0905-15 ½ ton 15-16 “ 6 stud wheels

24-0905-15K ½ ton 15-16” 6 stud set of 5 w/hdw

Year

New

37-62

\$4.50

37-62

\$19.95



**Diameter**

Rim diameter is measured from tire bead seat area to tire bead seat area



**Width**

Rim width is measured from tire bead seat area to tire bead seat area

*Bill's Truck Shop*

Phone (905) 725-3460 / (905) 725-2022 / (905) 404-2302

# Bumpers and Brackets

Group 24

24-216-R



24-216-F



24-0586



### Bumper Bracket Kit w/ hardware

24-216-F	front 47-55 Chev and 49-55 GMC	47-55	\$189.95
24-216-R	rear 1/2 ton	47-55	\$194.95

3/4 ton & up have a lower "step" in the brackets for the deeper 4" frame see below

24-216-R1	rear 3/4 ton & 1 ton	47-55	\$349.95
-----------	----------------------	-------	----------

### Bolt-bumper bkt to frame

24-0586	1/2 x 2 w/ lock-flat washer & nut	each	\$3.95
---------	-----------------------------------	------	--------

### Spare Tire Mounts

24-2TH	hook w/ nut to support load bar	37-55	\$14.95
--------	---------------------------------	-------	---------

## Bill's Truck Shop

Phone (905) 725-3460 / (905) 725-2022 / (905) 404-2302

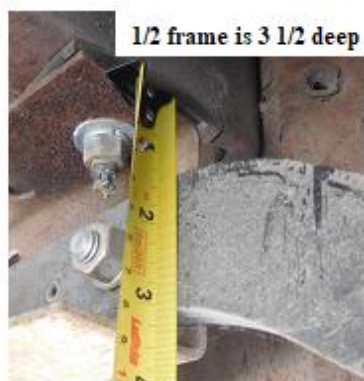



# Splash Aprons

Due to the fluctuation of the Canadian and American dollars call for current prices

Group 25

25-201-S



25-201-SG



25-202-P



25-203-C

25-203-4B



25-203-CB



1947-53 Chev big truck 3" wider end to end



Year      New

## Front Apron-bumper filler

25-201-S	steel	CHEV	47-53	\$169.95
25-201-C	chrome	CHEV	47-53	\$274.95
25-201-54S	steel	CHEV	54-55	\$159.95
25-201-4C	chrome	CHEV	54-55	\$279.95

25-201-SG	steel	GMC	Late 49-53	\$199.95
-----------	-------	-----	------------	----------

25-201-4FG	fibreglass	GMC	54-55	\$139.95
------------	------------	-----	-------	----------

## Rear Splash Apron-requires modification for 54-55 style drop-center bumpers

25-202-P	w/ fender ext-mounts at bumper		47-53	\$329.95
25-202-SP	suburban, panel-fibreglass w/ bkts		47-55	\$124.00

## Front License Bracket

25-203-B	black		47-53	\$21.95
25-203-C	chrome		47-53	\$29.95
25-203-4B	black		54-55	\$14.95
25-203-4C	chrome		54-55	\$29.95

## Front Plate Bracket Bolt set-secures bkt & plate

25-203-CB	4 stainless carriage bolts w/hdw		47-54	\$3.25
-----------	----------------------------------	--	-------	--------

## Rear Plate Bracket See group 17-18

*Bill's Truck Shop*

Phone (905) 725-3460 / (905) 725-2022 / Fax (905) 404-2302 email: bill@billstruckshop.com

Year      New

**Bed Wood**-Boards are cut to size with edges grooved-Kiln dried

No bed mount holes in boards

**NOTE**>47-51 w/ 8 bed strips( **9 boards**) or 51-53 w/ 7 bed strips ( **8 boards**) add \$70.00 when ordering w/ mount holes-special order



**RED OAK**

26-2234	Short Step	47-51	\$724.95
26-2248	Long Step 86'	47-51	\$759.95
26-2190	Long Step 107' 1 Ton	47-51	\$769.95
26-2236	Short Step	51-53	\$724.95
26-2250	Long Step 86'	51-53	\$759.95
26-2192	Long Step 107' 1 Ton	51-53	Inquire
26-0238	Short Step	54-59	\$624.95
26-0252	Long Step 89'	54-57	\$759.95
26-0433	Long Step 97'1/4 1 Ton	54-59	Inquire

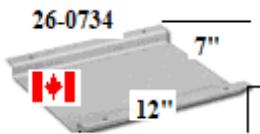

**Heat Shield** –to shield exhaust on wood floor over rear axle-prevents wood from burning

26-0734	galvanized/ includes hdw	each	47-72	\$33.95
---------	--------------------------	------	-------	---------

# Bed Strips

Due to the fluctuation of the Canadian and American dollars call for current prices

Group 26

Stainless steel bed strips are magnetic grade 430 bright stainless steel Year New

## Bed Strips

Stainless steel- pre punched w/ square holes 77"  
47-51 uses **8 strips (9 boards)**  
51-53 uses **7 strips(8 boards)**



### Steel Punched

26-2015	Short Step	77"	each	47-53	\$29.95
26-2042	Long Step	86 "	each	47-53	\$33.95
26-2329	Long Step	107' 1 ton	each	47-53	\$39.95
26-0018	Steel-Short Step	w/ 7pc	set	54-59	\$179.95
26-2045	Long Step	89' 7 pc	set	54-55	\$179.95
26-0684	Long Step	97' 1 Ton	set	54-59	\$199.95

### Polished Punched--- 77"

26-2013	Short Step	77"	each	47-53	\$59.95
26-2040	Long Step	86"	each	47-53	\$54.95
26-2327	Long Step	107' 1 Ton	each	47-53	\$59.95
26-0016	Short Step	w/7 pc	set	54-59	\$339.95
26-2043	Long Step	89'	set	54-55	\$379.95
26-0434	Long Step	107" 1 Ton	set	54-59	\$369.95

## PANEL & CANOPY EXPRESS

Inquire about 1 ton panel & canopy express

### SEE PICTURE FOR INFO

26-2664 Panel-Canopy Express 82" set has 4 short strips for wheel tubs-strips also sit UNDER end panel front and rear 12pcs **PST** ½ ton 47-51 \$349.95

26-2495 Panel-Canopy Express 79 ½ "  
-strips end @ front and rear sill **PST** 5pcs ½ ton 51-54 \$225.95

26-2497 Panel-Canopy Express 79 ½ "  
-strips end @ front and rear sill **STEEL** 5pc ½ ton 51-54 \$129.95

### Bed Bolt Kits

28-2590 Panel & Canopy Express ½ ton **STEEL** 47-51 \$125.00

**No bolt kit for 51-55 Canopy & Panel**

28-2286 Panel & Canopy Express ½ ton **PST** 47-51 \$189.95

**No bolt kit for 51-55 Canopy & Panel**

47-51---strips slide UNDER end covers at both ends bolts go through end plate and strips -total of 12 pcs



bolts are at end of strips -total of 5 strips  
51-54---strips STOP at end covers at both ends

*Bill's Truck Shop*

Phone (905) 725-3460 / (905) 725-2022 / (905) 404-2302

# Bed Strips

Due to the fluctuation of the Canadian and American dollars call for current prices

Group 26

Stainless steel bed strips are magnetic grade 430 bright stainless steel Year New

**BED STRIPS** can be ordered for special one of a kind application- call for pricing

**Stainless Steel w/ o holes**

26-0634	78 " long PST w/o holes	each	\$44.95
26-0160	89 " long PST w/o holes	each	\$59.95
26-0336	120 " long PST w/o hole	each	\$84.95

**Steel w/ o holes**

26-0007	77 1/8 long w/o holes	each	\$29.95
26-0008	97 " long w/o holes	each	\$39.95
26-0383	120" long w/o holes	each	\$59.95

When installing the bed and angle strip bolts do not over tighten-collapse the lock washer only - the bed strips will BEND when they are over tightened



**Custom "WOW" Bed Strips w/ hidden fasteners**

**Polished Stainless Steel:** custom strips w/ "T" type bolt slides on bottom of strip

26-0095	'T' bolts w /hdw as required -short bed requires 7	each	\$6.00
26-0083	97 " long - cut to fit	each	\$109.95

Custom Bed Strips w/ hidden fasteners



**STRIP KIT**

26-0083-K	7 strips 82 " w/ 49 "T" bolts and angle side hdw		\$899.95
-----------	--------------------------------------------------	--	----------

*Bill's Truck Shop*

Phone (905) 725-3460 / (905) 725-2022 / (905) 404-2302

# Angle Strips/Covers

Due to the fluctuation of the Canadian and American dollars call for current prices

Group 27



## Angle Strips

### Steel Punched -sold as pr

		<u>Year</u>	<u>New</u>
27-2111	Short Step	47-53	\$99.95
27-2132	Long Step 86'	47-53	\$89.95
27-2600	Long Step 1 Ton 107 "	47-53	119.95
27-0114	Short Step	54-59	\$84.955
27-2135	Long Step 89'	54-55	\$94.95
27-0140	Long Step 1 Ton	54-59	\$119.95

### Polished Punched -sold as pr

27-2109	Short Step	pair	47-53	\$129.95
27-2130	Long Step 86"	pair	47-53	\$139.95
27-2602	Long Step 107 "1 Ton		47-53	\$149.95
27-0112	Short step		54-59	\$144.95
27-2133	Long Step 89'		54-55	\$169.95
27-0437	Long Step 97' 1 Ton		54-59	\$159.95

When installing the bed and angle strip bolts do not over tighten-collapse the lock washer only - the bed strips will collapse when they are over tightened

*Bill's Truck Shop*

Phone (905) 725-3460 / (905) 725-2022 (905) 404-2302



# Bed Bolts

Due to the fluctuation of the Canadian and American dollars call for current prices

Group 28



**Bed Bolt Kits** Includes all necessary bolts, washers and nuts for mounting bed strips to wood and bed to frame. For replacement strips w/square holes. **Stainless steel bolts** are a non-magnetic grade w/ superior resistance to rust and corrosion

Ribbed bolt kits available (Inquire)

		<u>Year</u>	<u>New</u>
<b>Zinc</b>	<b>(BS = bed strips)</b>		
28-2350	Short step w/ 8 BS 77"	47-51	\$94.95
28-2377	Long Step 86". w/ 8 BS	47-51	\$94.95
28-2272	Long Step 107" 1 Ton .w/ 8 BS	47-51	\$104.95
28-2353	Short Step- w/ 7 BS	51-53	\$94.95
28-2275	Long Step 86".w / 7 BS	51-53	\$94.95
28-2278	Long Step 107" I Ton, w/ 7 BS	51-53	\$99.95
28-2356	Short Step	54-55	\$84.95
28-2281	Long Step 89"	54-55	\$84.95
28-0358	Long Step 97" I Ton	54-59	\$99.95

### Polished Stainless Steel

28-2348	Short Step w/ 8 BS	47-51	\$199.95
28-2375	Long Step 86".w/ 8 BS	47-51	\$219.95
28-2270	Long Step 107"/1 ton w/ 8 BS	47-51	\$221.95
28-2351	Short Step w/ 7 BS	51-53	\$199.95
28-2273	Long Step 86" w/ 7 BS	51-53	\$219.95
28-2276	Long Step 107" I Ton w/ 7 BS	51-53	\$221.95
28-2354	Short Step	54-55	\$194.95
28-2279	Long Step 89"	54-55	\$199.95
28-0439	Long Step 97" 1 Ton	54-59	\$199.95

*Bill's Truck Shop*

Phone (905) 725-3460 / (905) 725-2022/ (905) 404-2302

# Bed Bolts

Due to the fluctuation of the Canadian and American dollars call for current prices

Group 28



**Angle & Strips Bolt kit -PST** Use this kit when hiding bed to frame bolts under your boards  
28-2343

Year      New

51-53      \$94.95

**Bed Floor Offset Washers**

28-0211 1 ½ w/ offset square hole-stainless steel each \$7.95

28-0211-S 1 ½ w/ offset square hole-stainless steel each \$2.50

**BOLTS**

28-0114-P ¼ x 1' NC carriage bolt-PST w/ lock washer & nut each \$2.95

*Bill's Truck Shop*

Phone (905) 725-3460 / (905) 725-2022 / (905) 404-2302

# Front Bed Panels

Due to the fluctuation of the Canadian and American dollars call for current prices

Group 28



28-2609



28-0354-T



28-2695



28-2800-CS

**Front Bed Panel** Exact gauge with proper bends. 1947-53 front bed panels, includes mounting rod.

		<u>Year</u>	<u>New</u>
28-2609-T	½ & ¾ ton made in Taiwan	47-53	\$169.95
28-0354-T	made in Taiwan	54-59	\$189.95

### Front Bed Panel Mounting Bolts w/hdw

#### Zinc

28-2630-Z	8 bolts w/ washers & nuts zinc	47-53	\$5.95
23-0387-S	Cap screw style steel---step & fleet side	54-72	\$12.95

#### Stainless Steel

28-2800-CS	stainless steel carriage bolt w/ flat, lock washers & nuts-gives a smooth look to bed side mounting	47-53	\$11.95
28-2630-S	8 bolts w/ washers & nuts-stainless steel	47-53	\$7.95
23-0387-SS	Phillips head stain-steel / step & fleet	54-72	\$19.95

*Bill's Truck Shop*

Phone (905) 725-3460 / (905) 725-2022 / (905) 404-2302

# Tailgates & Covers

Due to the fluctuation of the Canadian and American dollars call for current prices

Group 29



## Tailgates

Complete - Stamped steel with correct bends-16 gage electro-galvanized steel US and Taiwan (T) **black primer** 1947-53 bed is side angle top—1954 up is side flat top

**Chevrolet** w/ block letters

29-2643-T	Taiwan made/black primer	47-53	\$429.95
-----------	--------------------------	-------	----------

23-0SCHEV-T	step side/Chevrolet-Taiwan made	54-87	\$495.95
-------------	---------------------------------	-------	----------

**GMC** w/ script letters

29-2644-T	Taiwan made/black primer	47-53	\$399.95
-----------	--------------------------	-------	----------

23-2GMC	step side with original GMC script	54-54	\$595.95
---------	------------------------------------	-------	----------

23-0SGMC	step side new style letters	54-87	\$495.95
----------	-----------------------------	-------	----------

## Blank (smooth)

29-2630-T	Taiwan made	47-53	\$349.95
-----------	-------------	-------	----------

23-0SBLANK	Taiwan made	54-87	\$279.95
------------	-------------	-------	----------

## Bowtie (embossed) special order

23-0694	US made	54-87	\$469.95
---------	---------	-------	----------

*Bill's Truck Shop*

Phone (905) 725-3460 / (905) 725-2022 / (905) 404-2302

# Tailgate Hardware

Due to the fluctuation of the Canadian and American dollars call for current prices

Group 29

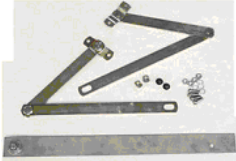

29-2835



22-0SLK-S



29-210



23-0SZ



22-0CCB

22-0547-S

23-0381



29-212-S

29-212-SS



## Tailgate Link kit- w/ instructions

		<u>Year</u>	<u>New</u>
29-2835	ZINC-arms w/ hdw for removal of chains	41-53	\$169.95
29-2835-S	stainless steel-arms w/ hdw for removal of chains	41-53	\$324.95

## Step side Stealth Tailgate Latches (pair)

Slotted stainless barrel w/spring loaded lock pin that is installed into the top gate roll & inserts in gate post

22-0SLK-S	stainless steel	pair	41-87	\$119.95
-----------	-----------------	------	-------	----------

## Tailgate Chains

29-210	cadmium plated-pr		32-53	\$49.95
29-210-SS	stainless steel-pr		32-53	\$97.95
23-0SZ	zinc		54-87	\$49.95
23-0SS	stainless steel		54-87	\$99.95

## Tailgate Chain Covers

22-0CCB	black-	pair	47-87	\$12.95
22-0CCC	clear-	pair	47-87	\$12.95

## Tailgate Trunions (Hinge)

		pair		
29-212-SS	chrome	pair	41-53	\$69.95
29-212-S	steel	pair	41-53	\$43.95
22-0547-S	zinc w bolts	pair	54-87	\$29.95
23-0381	urethane w/ SS bolt	pair	54-87	\$54.95

*Bill's Truck Shop*

Phone (905) 725-3460 / (905) 725-2022 / (905) 404-2302



30-201-B

23-0CSB



23-0GSB

30-201-2B



30-201-W

30-201-CR



30-0601-FI

### Tailgate Letters-stick decals

#### Black

		<u>Year</u>	<u>New</u>	<u>Used</u>
30-201-B	CHEVROLET / black	47-53	\$9.95	
23-0CSB	CHEVROLET / black	54-87	\$9.95	
30-201-2B	GMC / black	47-53	\$9.95	
23-0GSB	GMC / black	54-87	\$9.95	

#### White

30-201-W	CHEVROLET / white	47-53	\$9.95	
23-0CSW	CHEVROLET / white	54-87	\$9.95	
30-201-2W	GMC / white	47-53	\$8.95	
23-0GSW	GMC / white	54-87	\$9.95	

#### Chrome

30-201-CR	CHEVROLET / chrome	47-53	\$9.95	
23-0CSC	CHEVROLET / chrome	54-87	\$9.95	
30-201-2CR	GMC / chrome	47-53	\$9.95	
30-201-2SS	GMC / brushed stainless	47-53	\$9.95	
23-0GSS	GMC / brushed stainless	54-87	\$9.95	

#### Grey

30-201-G	CHEVROLET / grey	47-53	\$9.95	
----------	------------------	-------	--------	--

**Tailgate emblem** fleetside or stepside-  
87-88 Tailgate Emblem - FUEL INJECTION, adhesive back

\$49.95

*Bill's Truck Shop*

Phone (905) 725-3460 / (905) 725-2022 / (905) 404-2302

# Bed Cross Sills

Due to the fluctuation of the Canadian and American dollars call for current prices

Group 29

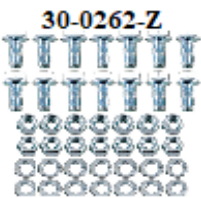
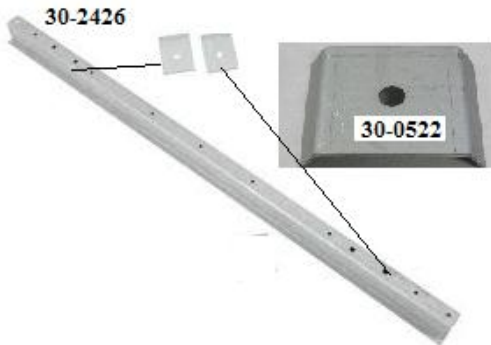
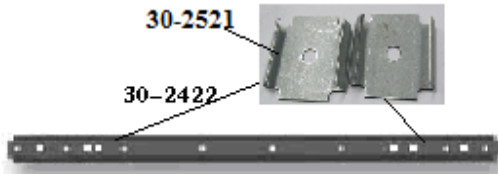

ALBED CROSS LISTED BELOW ARE 1/2 TON Year New  
 47-53 short beds use 1 front, 2 center and 1 rear cross sill---long step beds use 1 front, 4 center and 1 rear cross sill /// 54-55 uses 3 cross sills  
**NOTE**>47-51 w/ 8 bed strips( **9 boards**) or 51-53 w/ 7 bed strips ( **8 boards**)

**Bed Cross Sill** Includes bed support plates and are predrilled for strips & brackets (BS = bed strips)

30-2422	front w/ 8 BS-drilled for fit bed panel	47-51	\$69.95
30-2423	center w/ 8 BS	49-51	\$69.95
30-2599	2 <sup>nd</sup> sill @ fuel tank-w/ recess for under bed tank-does not bolt to frame	47-48	\$139.95
30-2424	front w/ 7 BS-drilled for fit bed panel	51-53	\$69.95
30-2425	center w/ 7 BS	51-53	\$69.95
30-2426		54-55	\$79.95

**Cross Sill Support Plates-step side**

30-2521		pair	40-53	\$6.50
30-0522	between sill and frame w/ bolt hole	each	54-87	\$2.50

**Rear Cross Sill**

**Sill support stands distance 1/2 -3/4 ton 44"**  
 -----1 ton 33 3/4"

30-2627	1/2 ton w/ 8 BS	47-51	\$259.95
30-2629	1 ton w/ 8BS	47-51	\$324.95
30-2617	1/2 ton w/ 7 BS	51-53	\$224.95
30-2618	3/4- 1 ton w/ 7BS	51-53	\$295.95
30-2713	1/2 ton	54-55	\$199.95
30-2714	3/4 Ton	54-55	\$269.95

**Reinforcement Strip** on bed floor at wheels

30-0437	54-59 long step & 58-59 fleet	54-59	\$44.95
23-0706	w/ out holes	54-87	\$25.00

30-0262-Z	Rear cross sill hdw-kit 42pcs	37-53	\$19.95
-----------	-------------------------------	-------	---------

*Bill's Truck Shop*

Phone (905) 725-3460 / (905) 725-2022 / (905) 404-2302

# Roll Pans and Hardware

Group 30

30-2604-T



30-0826-T



30-0204-T

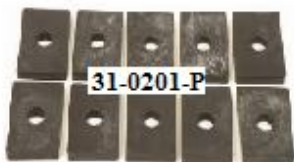

31-0201-P



31-0202-SS

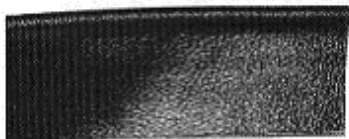

31-0WFB

30-2724-L



30-2724

Year      New      Used

**Rear Roll Pan (Steel)** Welds or screws to rear cross sill & bed sides-rear cross sill will have to be cut to accept plate box—**FIT SHORT BED ONLY**----- side extension to fender approx 8" long

**-with License Plate Box**

30-2604-T      smooth-made in Taiwan      47-53      \$274.95

30-0826-T      smooth-made in Taiwan      54-87      \$239.95

24-0483      smooth – **long step**      USA made      54-87      \$279.95

**-without License Plate Box**-using original side mount plate bkt for license plate

30-2816      smooth      47-53      \$189.95

30-2836      4 Row Louvered      47-53      \$239.95

24-0817      smooth w/ out plate box      54-87      \$249.95

24-0839      4 Row Louvered      54-87      \$239.95

**Rear Roll Pan Tag Light** For rear roll pan with license plate box

30-0204-T      top mount      \$12.95

**Bed Mounting Blocks and Pads**      hardwood & rubber pads

30-2724      short bed      47-53      \$26.95

30-2724-L      long bed      47-53      \$36.95

**Bed Mounting Pads – Rubber**

31-0201-P      10 pcs      54-72      \$14.95

**Rear Step Fender Bolt Kit** w/washers and nuts.

31-0202-SS      stainless steel w/clutch head screw      47-66      \$69.95

31-0202-SS-P      stainless steel w/philips head screw      47-66      \$69.95

25-06025      zinc w/ Philips head      47-72      \$26.95

**Rear Step Fender Welt Beading**

31-0FWB      black vinyl 25'      47-72      \$29.95

*Bill's Truck Shop*

Phone (905) 725-3460 / (905) 725-2022 / (905) 404-2302

# Bed Sides

Due to the fluctuation of the Canadian and American dollars call for current prices

Group 31

Year      New

Bed sides are made from 16 gauge electro-galvanized steel and come with angels installed, stake pockets, fender holes, .Items w/ T are off shore produced parts

Taiwan (T) are also OE style and are black primer



31-2635

31-2635-T      Taiwan made      short bed      left      47-53      \$749.95

31-2410



31-0407



31-0408

31-2636-T      Taiwan made      short bed      right      47-53      \$749.95

fender lines embossed

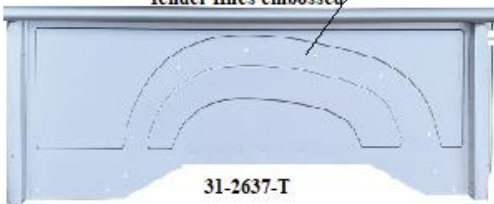

31-2637-T

31-2637-T      w/fender embossed      short bed      left      54-55      \$750.00

31-2638-T      w/fender embossed      short bed      right      54-55      \$750.00

**Stake Pocket** Vertical support at front & rear of step side bedside



23-2190

31-2413      rear left      47-53      \$129.95

31-2410      rear right      47-53      \$129.95

31-0408      front left      54-72      \$99.95

31-0405      front right      54-72      \$99.95

**Stake Pocket Covers** – steel w/ side clips

23-2190      steel/pair      47-53      \$44.95

*Bill's Truck Shop*

Phone (905) 725-3460 / (905) 725-2022 / (905) 404-2302

# Bed Parts

Due to the fluctuation of the Canadian and American dollars call for current prices

Group 31

31-0649

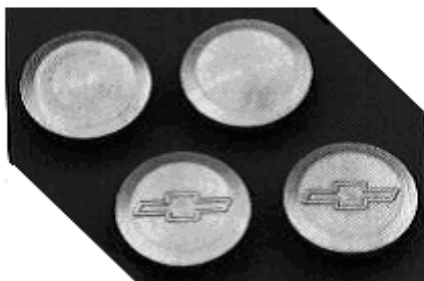

31-0752



22-0SLK-S

31-0864



22-0LFP

Year      New      Used

**Bed Hole Plugs** Aluminium plug fits in hole at front and rear of *step side* bed rails. With rubber O-ring -- press in

**Blank**      aluminium polished

31-0649-B      aluminum-brushed      pair      47-66      \$47.95

**STEPSIDE TAILGATE EDGE PROTECTOR**

Screw & or urethane to gate

22-0STP-B      black satin stainless steel      54-87      \$79.95

22-0STP      brushed stainless steel      54-87      \$79.95

**Step side Stealth Tailgate Latches (pair)**

These latches are great for people who are trying to eliminate the tailgate chains front their step side truck. These hidden latches use a slotted tubular channel to guide a spring loaded locking pin. They can be mounted inside the tailgate where they are completely out of sight. Only a small actuating knob is visible.

22-0SLK-S      stainless steel      47-87      \$159.95

22-0FLP

Flip down rear plate bkt

\$39.95

*Bill's Truck Shop*

Phone (905) 725-3460 / (905) 725-2022 / (905) 404-2302

# Running Boards & Parts

# Group 32

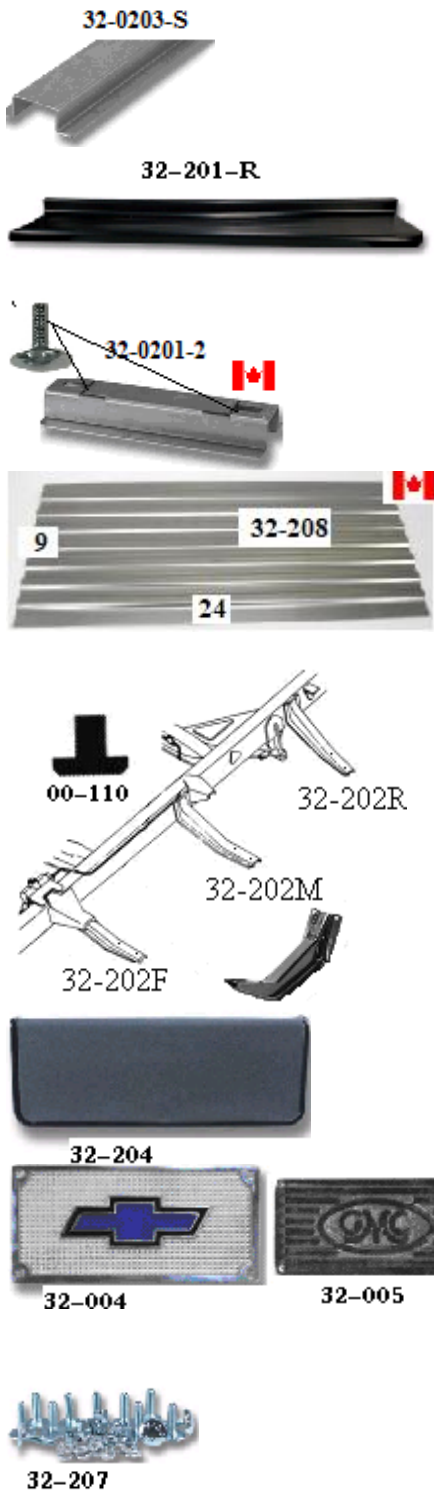

**Running boards - ribbed like original w/ support brackets**

			<u>Year</u>	<u>New</u>
32-201-R	short bed	R	47-55	\$449.95
32-201-RC	CHROME/short bed	R	47-55	\$564.95
32-201-L	short bed	L	47-55	\$449.95
32-201-LC	CHROME/short bed	L	47-55	\$594.95

32-0201-2	7' long - trim for location -	each	34-55	\$29.95
32-101-9	9" long trim for location-	each	34-46	\$29.95

**Running board Underside Reinforcement Brackets**

32-0203-S	30 "brace that is welded to running board w/ weld in holes for easy install	each	34-55	\$24.95
-----------	-----------------------------------------------------------------------------	------	-------	---------

**Running board Patch Panel**

32-208	18 gauge-- 9" W x 24" L	each	47-55	\$38.95
--------	-------------------------	------	-------	---------

**Running board Support - frame to running board- ft & center fit all models / center is also on the rear of all long step side trucks**

32-202-LK	3 pc set for <b>left</b> side-1/2 ton		47-55	\$259.95
32-202-RK	3 pc set for <b>right</b> side -1/2 ton		47-55	\$259.95

**Support Rivets-used on all cab. running board, shock etc brackets- for the original look**

00-110	5/16 x 1/2 soft steel			\$0.30
--------	-----------------------	--	--	--------

**Running board Safety Treads - reproduction of an original GM accessory**

32-204	black w/ non slip finish-9x21 pr w/ hdw		47-55	\$129.95
--------	-----------------------------------------	--	-------	----------

**Running board Step Plates pair w / hdw**

32-004	polished alum w/Chev bowtie-5 1/2 x11-pr			\$114.95
32-005	non pol alum w /older GMC design 5x10 5/8-pr			\$89.95

**Running board Bolt Kit -includes bolts in running board for skirt bkt -- 1 per board**

32-0207	steel - for 2 sides		36-55	\$16.95
---------	---------------------	--	-------	---------

*Bill's Truck Shop*

Phone (905) 725-3460 / (905) 725-2022 / (905) 404-2302

# Running Board Parts

Due to the fluctuation of the Canadian and American dollars call for current prices

Group 32

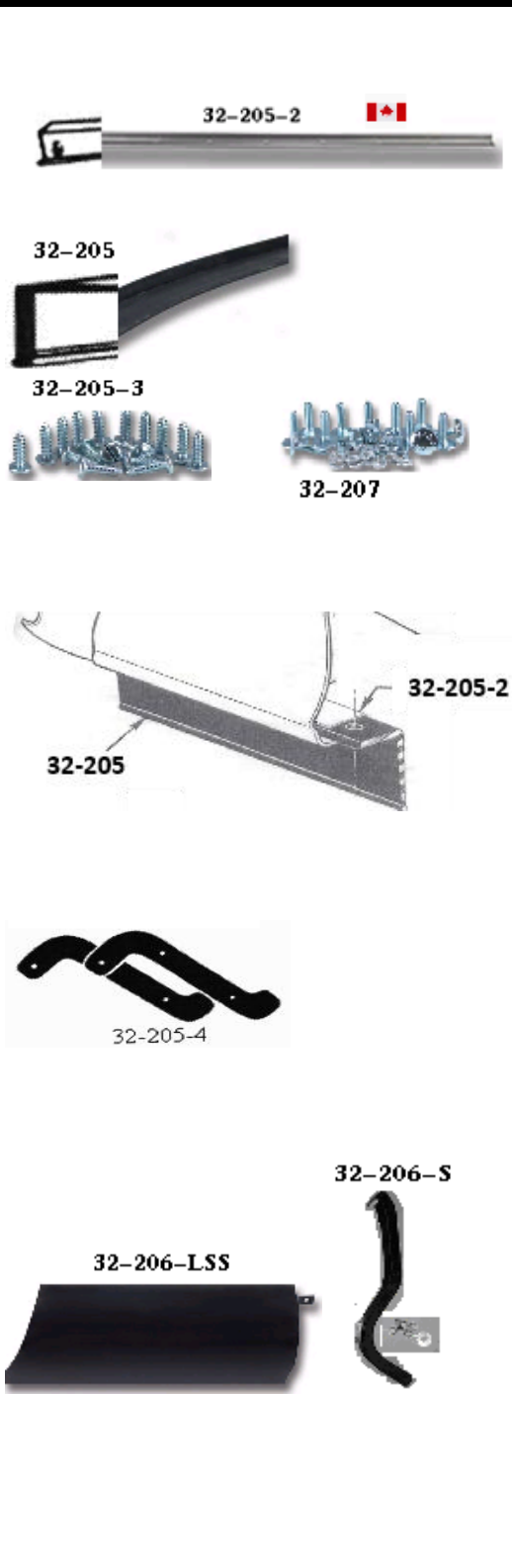

			<u>Year</u>	<u>New</u>
<b>Cab to Running board Seals</b>				
32-205	pickup	pair	47-55	\$48.95
32-205-1	panel/suburban	pair	47-55	\$54.95
<b>Running board Seal Retainer</b>				
32-205-2	pickup	1 per side-- 2 per side on panel/suburb	each	47-55
		Canada made		\$27.95
<b>Running board Seal Retainer Screw Set</b>				
32-205-3		18 pcs	47-55	\$5.95
<b>Running board Rear Fender Seals (pair)</b>				
32-205-4			47-55	\$10.95
<b>Running board Splash Apron w/o support</b>				
32-206-LSS	short step-left		47-53	\$99.95
32-206-RSS	short step-right		47-53	\$99.95
32-206-LLS	long step-left		47-53	\$129.95
32-206-RLS	long step-right		47-53	\$129.95
32-206-4LSS	short step-left		54-55	\$129.95
32-206-4RSS	short step-right		54-55	\$129.95
<b>Splash Apron Support w/ hdw</b>				
32-206-S	L or R	each	47-53	\$19.95
32-206-4S	L or R	each	54-55	\$19.95
<b>Running board Bolt Kit --includes bolts in running board for skirt bkt -- 1 per board</b>				
32-207	steel - for 2 sides		47-55	\$16.95

*Bill's Truck Shop*

Phone (905) 725-3460 / (905) 725-2022 / Fax (905) 404-2302 email: bill@billstruckshop.com

# Sheet Metal Repair Panels

# Group 33

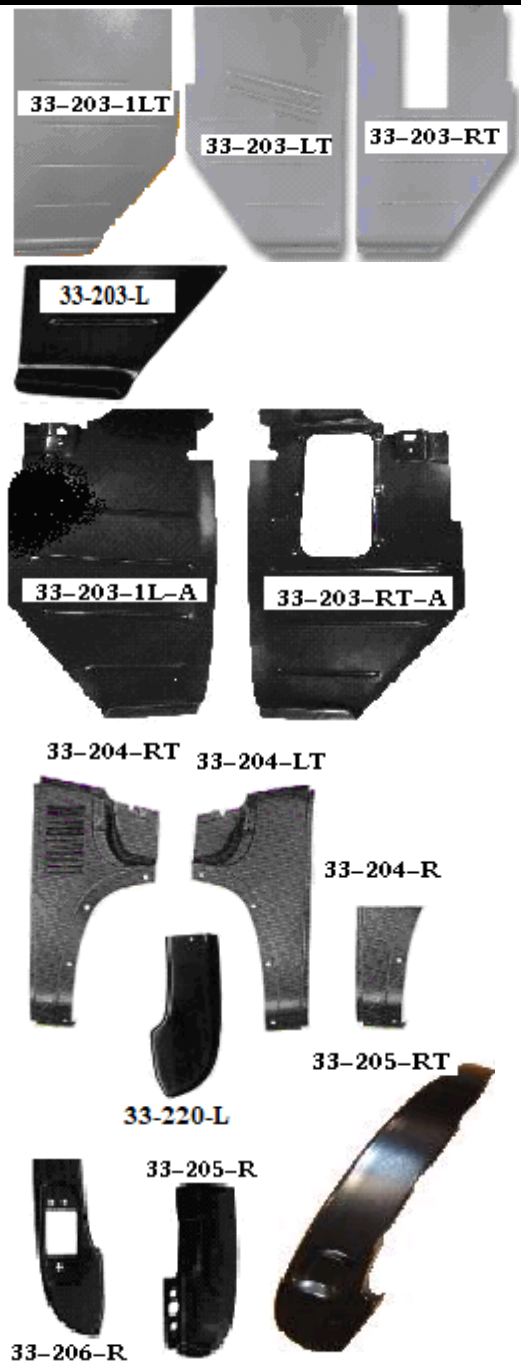

			<u>Year</u>	<u>New</u>
<b>Inner Cowl Panel-</b>				
33-203-L	9 " high	<b>left</b>	47-55	\$44.95
33-203-R	9 " high	<b>right</b>	47-55	\$44.95
33-203-LT	25 " high w/ vent louvers	<b>left</b>	47-50	\$69.95
33-203-1LT	25 " high w/ out vent louvers-(BUT can be installed )can also be used on 47-50 if closing left outer vent	<b>left</b>	50-55	\$105.95
33-203-1L-A	<b>full replacement panel</b> w/o louvers –install @ OE seams	<b>left</b>	50-55	\$105.95
33-203-RT	25 " high w/ dlx heater opening	<b>right</b>	47-55	\$74.95
33-203-RT-A	<b>full replacement panel</b> w/ dlx heater opening –install @ OE seams	<b>right</b>	47-55	\$104.95
<b>Outer Cowl - 16 " high</b>				
33-204-R		<b>right</b>	47-55	\$109.95
33-204-L		<b>left</b>	47-55	\$109.95
<b>Outer Cowl- "T" are full replacement panels</b>				
33-204-LT47	w/ cowl vent opening	<b>NEW left</b>	47-50	\$129.95
33-204-LT	w/ out cowl vent opening for 47-50	<b>left</b>	47-55	\$129.95
33-204-RT	w/ louvers	<b>right</b>	47-55	\$139.95
<b>Inner /Outer Cowl - "T" are full replacement panels</b>				
33-205-R	12' high	<b>right</b>	47-55	\$59.95
33-205-L	12" high	<b>left</b>	47-55	\$59.95
33-205-LT	24 " high	<b>left</b>	47-55	\$119.95
33-205-RT	24" high	<b>right</b>	47-55	\$119.95
<b>Hinge Pocket-front lower a "A" pillar–hinge nut w/ cage not included 13" tall</b>				
33-206-L		<b>left</b>	47-55	\$86.95
33-206-R		<b>Right</b>	47-55	\$86.95
<b>Lower Cab Rear "B" Pillar- door post lower @ rocker</b>				
33-220-L	12"	<b>left</b>	47-55	\$74.95
33-220-R	12"	<b>right</b>	47-55	\$74.95

*Bill's Truck Shop*

Phone (905) 725-3460 / (905) 725-2022 / (905) 404-2302

# Sheet Metal Repair Panels

# Group 33



33-209-R



33-209-IR



32-209-1R-47

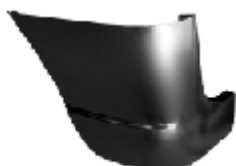

33-230-L



33-231-L

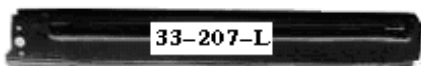

33-207-L



33-218-R



33-219

### Cab Corner-

		<u>Year</u>	<u>New</u>
33-209-L	15 " high & into door opening	47-55	\$109.95
33-209-R	15" high & into door opening	47-55	\$109.95
<b>Inner Cab Corner-1947-48 (no gas tank in cab) approx. 6" high----USA made</b>			
33-209-1L-47	left	47-48	\$35.95
33-209-1R-47	right	47-48	\$35.95
33-209-1L	left	47-55	\$59.95
33-209-1R	right	47-55	\$59.95

### Front Fender Rear Lower-approx 18" high

33-230-L	left	47-55	\$219.95
33-230-R	right	47-55	\$219.95

### Front Fender Front Lower

33-231-L	13 ¾ H	left	47-55	\$244.95
33-231-R	13 ¾ H	right	47-55	\$244.95

### Front Cab Support

33-218-L	left	47-55	\$69.95
33-218-R	right	47-55	\$69.95

### Rear Cab Support- come on 49-55 w/ side shackle mount only but need to be installed when changing 47-48 cabs to side shackle mount

33-219	fits right & left	49-55	\$46.95
--------	-------------------	-------	---------

### Rocker Panel ( note can also be used on COE cabs )

33-207-L	left	47-55	\$83.95
33-207-R	right	47-55	\$83.95

*Bill's Truck Shop*

Phone (905) 725-3460 / (905) 725-2022 / (905) 404-2302

# Sheet Metal Repair Panels

## Group 33

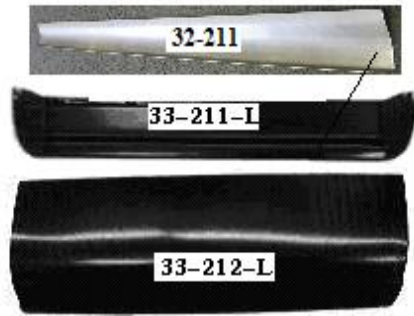

### Inner Door Lower 5 1/2" high

		Year	New
33-211-L	left	47-55	\$79.95
33-211-R	right	47-55	\$79.95

### Outer Door Bottom 12" high

33-212-L	left	47-55	\$94.95
33-212-R	right	47-55	\$94.95

### Retainer-Brake & clutch seat -w/ weld in holes

7-203-47R	1 1/2" wide	pair	47-51	\$19.95
7-203-52R		pair	52-55	\$12.95

BTS exclusive 



**Floor Pan w/Toe board**-all repro floor pans are made to use the smaller 47-51 seal retainer and are not installed on NEW pans w/o trans support see 33-217-SL & SR

33-217-1L	w/ 9" toe board	left	47-55	\$144.95
33-217-1R	w/ 9" toe board	right	47-55	\$144.95

### NEW FLOOR PANS REQUIRE-33-217-SL or SR

**Support-floor pan edge @ trans cover** ( do not come w/ replacement floor pans )

33-217-SL	left	47-55	\$14.95
33-317-SR	right	47-55	\$14.95

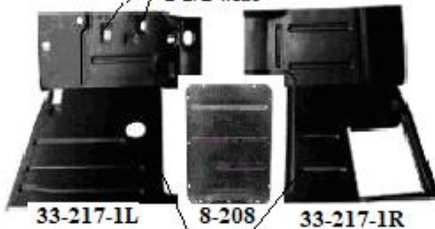

### Transmission Floor Cover 1/2 -1 ton

8-208	column shift	47-55	\$104.95
8-208-1	4-speed	47-55	\$119.95

33-217-SL  
33-217-SR



Check our website [www.billstruckshop.com](http://www.billstruckshop.com) for California trucks and parts

**Bill's Truck Shop**

Phone (905) 725-3460 / (905) 725-2022 / (905) 404-2302

# Sheet Metal Replacement Parts

# Group 34

Year      New



34-219-C

34-219-GS



49"

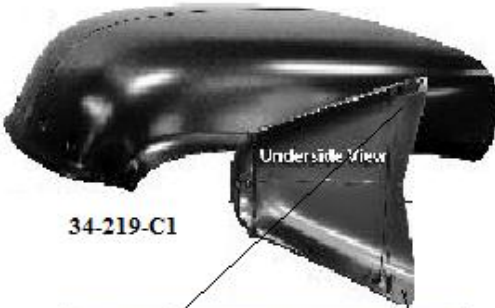

34-219-C1

Underside View



34-219-LB

34-219-RB



34-2112-SS

34-2112-HK



34-2113-B

## Hood --CHEV

34-219-CS 1 pc hood w/o center strip slits w/ emblem embossed **Chev** 47-55 \$1199.95

## HOOD--GMC

34-219-GS 1 pc/seamless hood GMC 47-55 \$999.95

GMC hood for 1/2-3/4 ton approx. 49" long from front to rear on side emblem line—bigger truck are approx. 52 "

## Hood Latch Panel-----CHEV

34-2112-SS stainless steel w/ release Chev 47-55 \$524.95  
 34-2112-B black w/ release Chev 47-55 \$329.95  
 34-2112-BWL black w/o release Chev 47-55 \$199.95  
 34-2112-HK stainless Philips drive bolts w/ washers excellent kit for the stainless latch panel 12 bolts w/ wash 47-55 \$15.95

## Hood Latch Panel-----GMC

34-2113-B black w/ out latch GMC 47-55 \$329.95  
 34-2113-C chrome w/ latch GMC 47-55 \$307.00

See section 3 for hood latches

*Bill's Truck Shop*

Phone (905) 725-3460 / (905) 725-2022 / (905) 404-2302

# Sheet Metal Replacement Parts

Group 34



34-220-R

**Inner Fender 3 per side - holes to be drilled for GMC grille supports**

34-220-L left 47-55 \$269.95

34-220-R 47-48 truck did not have a push pedal park brake & inner fender bolted directly to firewall-they will require # 34-220-S to install the replacement right inner on 47-48--- also have 6 " round holes in front w/ rubber liner for grille support bar 47-55 \$269.95

7-204-BS



34-220-S

34-220-S1

**Support-inner fender w/ park brake**

34-220-S on L firewall for inner fender & park support 47-55 \$99.95

34-220-S1 new replacement inner to outer fender support when NOT installing the OE style park brake assembly-----NEW ITEM 47-55 \$34.95



34-2113-U

GMC



34-2113-F

**Upper Rad Support Brace**

34-2113-U 47-55 \$159.95

**Upper Front Rad Shroud**

34-2113-F 47-55 \$189.95



34-2113-B

*Bill's Truck Shop*

Phone (905) 725-3460 / (905) 725-2022 / (905) 404-2302

# Sheet Metal Replacement Parts

Group 34

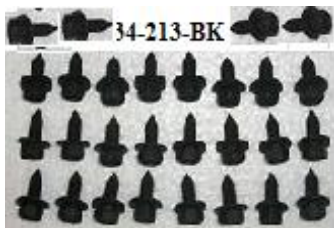

When purchasing rad supports ( Chev or GMC ) please confirm after viewing pictures at bottom of page---some GMC w/ Chev 6 cyl will have a Chev Rad support

### Rad Support

34-213-C **Chev** has side by side mounts on bottom-----includes fender support braces 5 pcs 47-55 \$769.95

34-213-CB has side by side mounts on bottom ----  
-----w/o out fender support braces 3 pcs 47-55 \$475.95

34-213-UB ----rad support upper cross brace-w/nut installed--not included in new rad supports -Chev only- can also be used when installing Chev rad (top fill) in GMC truck ( rad front fill )-secures hood latch panel to support when NOT using upper GMC cover /bar #34-2113-F 47-55 \$124.95

34-213-G **GMC**-does not use upper cross brace-see previous page for GMC upper hood latch braces & panels 49-55 \$499.95

### Upper Rad Support Brace

34-2113-U 47-55 \$159.99

### Bolt-kit-rad support

34-213-BK 28 pcs 47-55 \$34.95

### Fender-Rad Support Brace

34-221-RBR 1/2 -3/4- 1 ton right 47-55 \$89.95

34-221-RBL 1/2 -3/4- 1 ton left 47-55 \$89.95

34-221-RB truck w/ 18 wheels and up each L or R 47-55

## Bill's Truck Shop

Phone (905) 725-3460 / (905) 725-2022 / (905) 404-2302



# Sheet Metal Replacement Parts

# Group 34



34-221-FS



34-221-SB



34-243

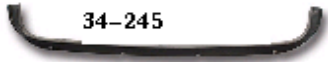

34-245

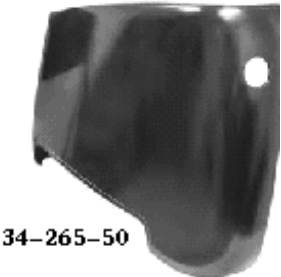

34-265-50



34-221-47L

park light hole

## Front Fender Bolt kit-inner & outer fenders

		<u>Year</u>	<u>New</u>
34-221-FS	stainless steel bolts, washers, nuts, screws	47-55	\$62.95

## Fender -Firewall Braces-firewall to fenders

34-221-SB	left or right w/ bracket	each	47-55	\$39.95
34-211-BSS	stainless steel w/ bkt & hdw	pair	47-55	\$134.95

## Fender-Rad Support Brace

34-221-RBR	½ -3/4- 1 ton	right	47-55	\$89.95
34-221-RBL	½ -3/4- 1 ton	left	47-55	\$89.95

34-221-RB	truck w/ 18 wheels and up	each L or R	47-55	
-----------	---------------------------	-------------	-------	--

## Rear Cab Inner Braces

34-243	set of 3	47-55	\$99.95
--------	----------	-------	---------

## Rear Cab Outer Cross Sill-belt line

34-245		47-55	\$119.95
--------	--	-------	----------

## Cab Rear Lower Panel

34-265-50	up to belt line—NO gas hole	47-55	\$664.95
-----------	-----------------------------	-------	----------

## Front Fenders-fender to rad support brace not included

34-221-47L		left	47-53	\$799.95
34-221-47R		right	47-53	\$799.95
34-221-47GL	GMC w/ park light hole	left	47-53	\$849.95
34-221-47GR	GMC w/park light hole	right	47-53	\$849.95
34-221-54L		left	54-55	\$799.95
34-221-54R		right	54-55	\$799.95

*Bill's Truck Shop*

Phone (905) 725-3460 / (905) 725-2022 / (905) 404-2302

# Sheet Metal Replacement Parts

# Group 34



		<u>Year</u>	<u>New</u>
<b>Cab Floor</b>	-bare for custom trucks		
34-206-A	w/out seat frame/tank support etc	47-55	\$999.95
<b>Cab Floor -original style</b>			
34-206-B	w/ seat frame(loose)/tank support -correct for 49-55 w/ fuel tank in cab	47-55	\$1199.95
<b>Seat Frame Support</b>	-ft & rear supports on cab floor -includes tank base w/ straps		
34-206-S		47-55	\$299.95
<b>Cab Firewall</b>	w/ front floor		
34-209	w/o heater application holes	47-55	\$495.00
<b>Dash Panel</b>	—OE 47-48 dash is not recessed for column shift lever as they were all floor shift		
34-211-47	Chev/GMC 1st series	47-53	\$575.00
<b>Support-dash to firewall</b>			
34-211-47S		47-53	\$70.95

*Bill's Truck Shop*

Phone (905) 725-3460 / (905) 725-2022 / (905) 404-2302

# Sheet Metal Doors/Fenders

Group 34



		<u>Year</u>	<u>New</u>
<b>Doors</b> -all doors empty shells only			
34-247-LD	w/ turn down handles w /o vent window L	47-50	\$799.95
34-247-RD	w/ turn down handle w/o vent window R	47-50	\$799.95

34-253-LD	w/push button handle w/ vent window L	52-55	\$825.95
34-253-RD	w/push button handle w/ vent window R	52-55	\$825.95

### Door Hinges

See section 12

**Lower Door Access Panels** (each)OE used has 1/4 hole for machine screw & 54-55 has hole for # 8 screw—all replacements are the 47-53 style

12-207-47L	left	47-55	\$89.95
12-207-47R	right	47-55	\$89.95

### Rear Fenders w/ upper inner support brace (pickup only) all sizes trucks

34-230-L	left	47-55	\$899.95
34-230-R	right	47-55	\$899.95

### Crown Brace-Rear Fender

34-230-CB	fits left or right	each	47-55	\$59.95
-----------	--------------------	------	-------	---------

Used parts pricing vary depending on condition

### Rear Fender Front Lower @ running board

33-225-L	6" high	left	47-55	\$69.95
33-225-R	6" high	right	47-55	\$69.95
33-225-S	<b>"L" reinforcement w/ rear fender patch @ running board pr</b>		47-55	\$13.95



*Bill's Truck Shop*

Phone (905) 725-3460 / (905) 725-2022 / (905) 404-2302

# Sheet Metal Doors/Fenders

Group 34

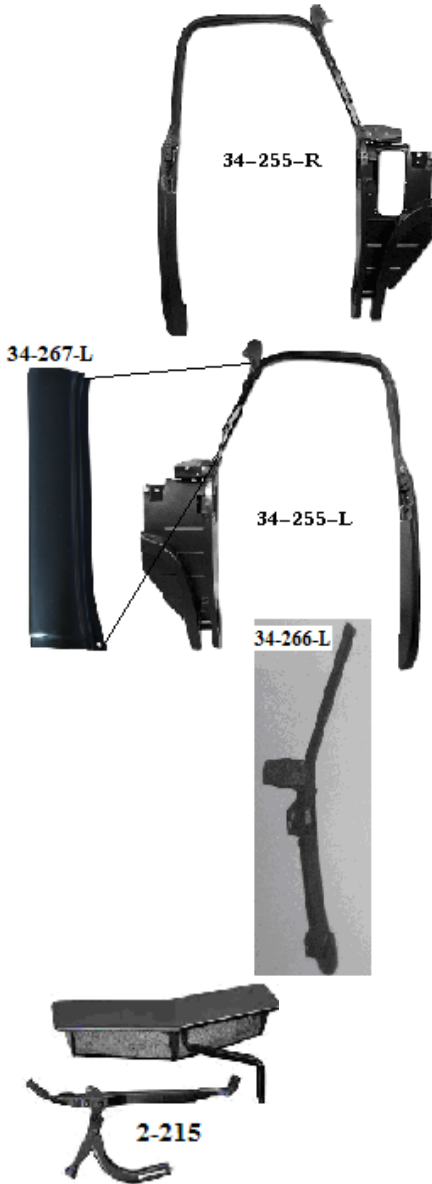

### Outer Door Frame

			<u>Year</u>	<u>New</u>
34-255-L	w/ inner @ inner to outer cowl panel	left	47-51	\$924.95
34-255-R	w/inner @ inner to outer cowl panel	right	47-51	\$725.00
34-255-52L	w/ inner @ inner to outer cowl panel	left	52-55	\$650.00
34-255-52R	w/ inner @ inner to outer cowl panel	right	52-55	\$650.00

### Front Door "A" Pillar approx 51" tall

34-266-L	includes hinge pockets w/ coarse thread nut installed		47-55	\$299.95
34-266-R	includes hinge pockets w/ coarse thread nut installed		47-55	\$299.95

### Pillar-outer "A" approx. 14" long

34-267-L		left	47-55	\$49.95
34-267-R		right	47-55	\$49.95

### Top Cowl Vent assembly

2-215	call for used parts		47-53	\$249.95
-------	---------------------	--	-------	----------

*Bill's Truck Shop*

Phone (905) 725-3460 / (905) 725-2022 / (905) 404-2302

# Sheet Metal REPLACEMENT PANELS

Group 34



		<u>Year</u>	<u>New</u>
<b>Cab- Inner Window /Roof Panel</b>			
34-245-3	w/ corner windows	47-55	\$499.00
<b>Cab-Outer Window/Roof Panel</b>			
34-246-1	w/ rear window only	47-55	\$570.00
34-246-3	w/ corner window	47-55	\$592.00
<b>Cab Roof</b>			
34-250-47		47-53	\$594.95
34-250-54		54-55	
<b>Inner Roof Panel-front</b>			
34-251		47-53	\$139.95
<b>Windshield Centre Post Support</b>			
34-252	roof to dash –support for window seal & trim	47-53	\$14.95
<b>Cab Cowl Panel outer w/cowl vent opening</b>			
34-260-47		47-53	\$495.00
34-260-54		54-55	
<b>Lower Splash Apron-supports inner fenders @ rad</b>			
34-262	Chev only	47-55	\$299.95
34-262-G	3 pc set GMC only	47-55	\$299.95
Inquire about separate GMC splash apron pcs			

*Bill's Truck Shop*

Phone (905) 725-3460 / (905) 725-2022 / (905) 404-2302

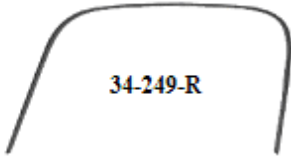

Used cab price can vary depending on condition Year New  
CAB w/ corner windows cab (5 window) can be ordered w/ many door combination—cab and doors are bare of working parts ---INQUIRE – used can be w/ or w/o corner window **Bare cab**

ONLY NEW CABS ARE PRICED IN AMERICAN \$

34-270-47	w/ turn handles w/ o vent window	47-50	Inquire
34-270-51	w/ turn handles w/ vent window	51-51	Inquire
34-270-52	w/ push handles-w/ vent window	52-53	Inquire
34-270-54	w/ push handles-w/ vent window	54-55	Inquire

**Cab Drip Rail**

34-249-L	left	47-55	\$89.95
34-249-R	right	47-55	\$89.95

*Bill's Truck Shop*

Phone (905) 725-3460 / (905) 725-2022 / 905- 404-2302

**CUSTOM REPAIR PANELS**

**Group 35**



**Upper Cowl Filler**

35-2002

Year

New

47-55

\$79.95

**Kick Panels**

35-2003

pair

47-55

\$200.00

**Toe Board**

35-2005

2 pcs

47-55

\$269.05

*Bill's Truck Shop*

Phone (905) 725-3460 / (905) 725-2022 / (905) 404-2302



# Suburban-Panel

# USA -CANADA MADE PARTS

Group 35

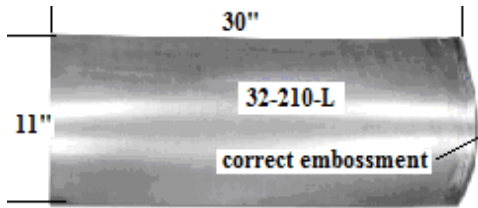

32-213-LR



32-213-RR

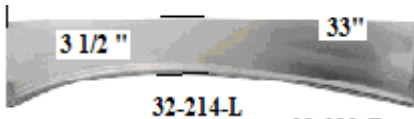
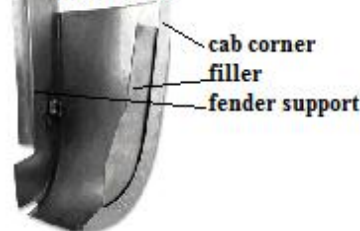

32-214-L

32-211-R



32-215-L



32-216

32-217

## Quarter Panel Repair 30 " long x 10.5 high

		Year	New
32-210-L	left	47-55	\$149.95
32-210-R	right	47-55	\$149.95

## Quarter Panel Fender Support Front—part of rear inner arch @ front of rear fender to body—cage nuts attached

32-211-L	left	47-55	\$54.95
32-211-R	right	47-55	\$54.95

## Quarter Panel Corner w/ Support @ rear—includes section to attaches rear of rear fender to rear corner w/ cage nuts attached & corner filler

32-213-LR	3 pcs	approx. 13"		
left			47-55	\$249.95
32-213-RR	3 pcs	approx. 13"		
right			47-55	\$249.95

## Rear Fender Arch 33 " long x 3 1/2" wide

32-214-L	left	47-55	\$119.95
32-214-R	right	47-55	\$119.95

## Rear Fender Repair-front lower

32-215-L	lower 6 1/2 x 10"long	left	47-55	\$69.95
32-215-R	lower 6 1/2 x 10"long	right	47-55	\$69.95

## Rear Valance Outer Edge @ rear door sill (tailpan) w/ rear barn doors 2 pcs

32-216	left &			
right/pr		47-55	\$159.95	

## Rear Valance replacement w/ rear barn doors 2 pcs (tailpan)

32-217	left &	47-55	\$159.95
right/pr			

Bill's Truck Shop

Phone (905) 725-3460 / (905) 725-2022 / (905) 404-2302

32-218-R



**Rear Fender---sub or panel**

**NEW**

32-218-L	left	47-55	\$1149.95
32-218-R	right	47-55	\$1149.95

32-0105-R



**Panel-Suburban rear door-gate**

32-0105-R	lift gate		
	recoiled/counterbalance-each	47-59	\$114.95

**Bill's Truck Shop**

Phone (905) 725-3460 / (905) 725-2022 / (905) 404-2302

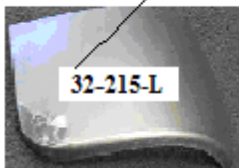
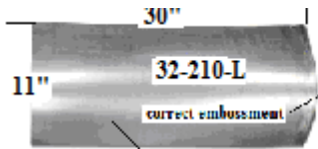

32-211-R



# Radio

Due to the fluctuation of the Canadian and American dollars call for current prices

# Group 36



		<u>Year</u>	<u>New</u>
<b>Telescopic Antenna</b> w/ cable and hardware & instructions			
36-205-T		47-55	\$154.95
<b>If installing a new ant in the existing hole make sure it is in the correct location as it will only fit in the OE location-tight up to the window seal-need to save a square edge on the antenna gasket-see picture</b>			
<b>Side Mount Antenna</b> -universal w/ cable and hardware -stainless steel			
36-0205-S	dual stand side mount	36-59	\$49.95
36-0205-S1	single stand side mount	36-59	\$49.95
<b>Radio Face Plate</b> Tuning Indicator			
36-207-47	plastic, Chevy, white letters w/tapered back case	47-49	\$24.95
36-207-50	plastic, Chevy, white letters w/ flat back on case	50-53	\$24.95
36-207-47G	plastic, GMC, red letters w/ tapered back on case	47-49	
36-207-50G	plastic, GMC, red letters w/ flat back on case	50-53	\$24.95
36-207-54	glass, Chevy, white letters	54-55	\$24.95
36-0207-54G	glass, GMC, white letters	54-59	\$24.95
<b>Radio Face Bezel</b>			
36-212-54	Chev and GMC	54-55	\$39.95
<b>Radio Bezel Spacer Casket</b>			
36-209-G	pair	47-53	\$2.75
<b>Radio Speaker Sponge</b>			
36-210-S	molded-around speaker opening	47-53	\$27.95
<b>Voltage Reducer</b> -for radio & heater motor			
4-0211-ER	1 ohm 50 watt metal incised		\$13.95
<b>Radio Power Wire</b> w/ fuse holder			
36-209-W	2 wire cotton braided like original	47-53	\$34.95



36-209-SL  
36-209-SLH



36-209-SU



### Radio Spacer

36-209-SU	upper -fits over tuning shafts between dash and case	pair	47-53	\$9.95
36-209-SL	lower – support radio @ base	pair	47-53	\$8.95

### Radio Mount Hdw

2 screws w/ washers

36-209-SLH	secures radio to lower dash		47-53	\$2.00
------------	-----------------------------	--	-------	--------

### Radio Dial Housing

36-209-DH	plastic maroon		47-53	\$34.95
-----------	----------------	--	-------	---------

### Radio Pushbutton & Tuning knobs

36-209-PB	tan- push button controls	5pcs	47-53	\$24.95
36-209-TV	tan- tuning-volume controls	4 pcs	47-53	\$29.95
36-209-54TV	black- tuning-volume controls	4pcs	54-55	\$35.95
36-209-54GTV	GMC grey-tuning-volume controls	4pcs	54-55	\$35.95

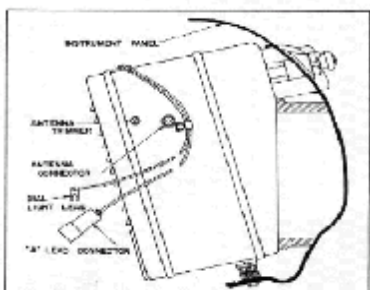

36-209-PB



36-209-DH

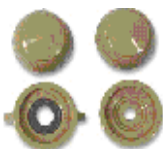

36-209-TV



36-209-54TV



GMC

*Bill's Truck Shop*

Phone (905) 725-3460 / (905) 725-2022 / (905) 404-2302

# Radio

Due to the fluctuation of the Canadian and American dollars call for current prices

Group 37



36-2013-DVC



36-220-KP



36-3USA-2

36-00VB



5-0HAN



5-00RC

**Dual Voice Cone Speaker**-one speaker w/ dual tweeters to provide 140 watts in the original speaker location- w/ brackets

36-2013-DVC 140 watts 47-53 \$99.95

**Kick panel Speaker set**-Plastic panels w/moulded speaker (4 " 2 way 60 watt speakers)-pair

36-220-KP 47-55 \$189.95

36-220 assembly w/o speakers 47-55 \$139.95

**Radio-AM/FM** – new 12V ,electronic shafts, aux inputs for iPod,MP3,DVD,Satellite, seek & scan, digital clock,200 watts w/ chrome bezel & CHEV logo-fits original location w/o any modification- w/ Chev logo

36-2USA-2 47-53 \$319.95

36-2USA-2-GMC 47-53 \$319.95

36-2USA-6 same as above w/ 240 watts & CD change controller 47-53 \$349.95

36-2USA-7 740 AM-FM Radio -w/bluetooth 47-53 \$549.95

**Radio-AM/FM** – new 12V ,electronic shafts, aux inputs for iPod,MP3,DVD,Satellite, seek & scan, digital clock,200 watts w/ chrome bezel & CHEV logo-fits original location w/o any modification-**Chev USA 740 W/ BLUETOOTH**

47-53 \$449.95

**Volt Booster**-will operate 12 volt negative ground accessories from 6 or 8 volt negative ground electrical systems. The maximum output power is a function of input voltage. When used in a 6 volt system, it can continuously supply more than 3- 1/2 amps with the engine off, and about 5 amps with the engine running at a fast idle. Because of its very efficient design, its current draw is negligible when no load is applied (10 milliamps).

NOT RECOMMENDED FOR: Power actuated door locks, trunk release solenoids, air conditioner clutches, fans, blowers, power windows, or other electromechanical devices.

36-00VB \$89.95

Amplified Electronic AM/FM Hidden Antenna—requires 12 volt-includes 80" cable- peel- stick application

5-0HAN universal \$49.95

**Condenser---Radio(noise) Suppression Condenser**

5-00RC when using point ignition \$36.95

*Bill's Truck Shop*

Phone (905) 725-3460 / (905) 725-2022 / (905) 404-2302

# Brakes

Due to the fluctuation of the Canadian and American dollars call for current prices

# Group 37



37-201-FR

37-0202-F



37-0330



37-203-F

37-0203-FL



37-0208-R



37-0325

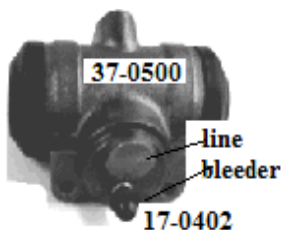

37-0500

17-0402

<b>Brake Shoes</b> (per axle) bonded shoes unless noted			
37-0201-FR-P	front or rear shoes set of 4 w /huck style brakes-adjusters on wheel cylinders-		
	bonded <b>premium grade</b> -non-asbestos w/FF (C.F )		
	coefficient of friction 11 x 1 3/4	36-50	\$69.95
37-201-FR	front or rear shoes set of 4 w /huck style brakes-adjusters on wheel cylinders - <b>service grade / bonded 11 x 1 3/4</b>	36-50	\$69.95
37-0202-F	1/2 ton front shoes 2" set of 4	51-62	\$49.95
37-0202-R	1/2 ton rear shoes 1 3/4 set of 4	51-59	\$79.95
37-0330	53-59 front & rear-64-70 rear 3/4 ton Brake shoe set- 12 x 2 set of 4	53-70	\$79.95
37-0014	14 x 2 1/2 -set of 4 46-52 1 ton rear & 46-52 1 1/2 front relined/bonded-huck style	46-51	\$225.00
37-0012	12 x2 set of 4 46-52 1 ton rear & 46-52 1 & 1 1/2 front relined/bonded-huck style	46-52	\$195.00
37-0204	14 x 2 1/2 rear set of 4 1 ton	53-59	Inquire

<b>Wheel Cylinder</b> (each) brake lines exit to front			
37-203-F	w/adjuster on cyl-36-50 1/2 ton-37-52 3/4 ton----37-42 1 ton---36-50 1 1/2 ton-47-50 2 ton 1/1/4 dia L or R front – each Huck style	36-52	\$69.95
37-203-R	w/adjuster on cyl - rear L or R 36-50 1/2 36-45 3/4 ton Huck style 1 3/16 cup size	36-50	\$99.95
37-0358	w/adjuster on cyl –rear L or R 37-45 w/ 14' brakes,46-52 3/4 rear L or R & 46-52 1 ton front 1 3/8 cup	37-52	Inquire
37-0203-FL	front left 1/2 ton 1 1/8 cup	51-59	\$39.95
37-0204-FR	front right 1/2 ton 1 1/8 cup	51-59	\$39.95
37-204-R	1/2 rear L or R 1 " cup	51-55	\$59.95
37-0209	3/4 front L or R 1.125 cup	53-59	\$79.95
37-203-1R	3/4 rear L or R	47-52	\$79.95
37-0209	3/4 rear L or R 1 1/4cup	53-59	\$79.95
37-0325	1 ton w 14 x 2 1/2 shoes/ huck style brakes - cast housing & adjuster 1 3/8 cup -fits L & R	46-52	\$189.95
37-0358	1 ton front L or R 1 3/8 bore	46-52	\$99.95
37-0209	1 ton front L or R 1 1/4 cup	53-59	\$79.95
37-203-3R	37-52 3/4 ton rear L or R- 1ton 46-52 ft or rear 1 3/8 cup size w/ huck style brakes	47-52	\$89.95
37-0209	1 ton rear L or R 1 1/4 cup	53-59	\$79.95
37-0208-R	1 1/2 -2 ton rear 1/ 1/2 dia –Huck style each	36-50	\$155.00
37-0499	rear cylinder or rear w/ dual cylinder 1 1/2- 2 ton Chev & GMC fit L or R each	53-59	\$155.00
37-0500	front cylinder or rear w/ dual cylinder 1 1/2- 2 ton Chev & GMC fit L and R each	53-59	\$155.00

## Bill's Truck Shop

Phone (905) 725-3460 / (905) 725-2022 / (905) 404-2302

# Brakes

Due to the fluctuation of the Canadian and American dollars call for current prices

# Group 37



37-0204-3/16



37-0054



37-0038



37-0050



17-0402



37-0051

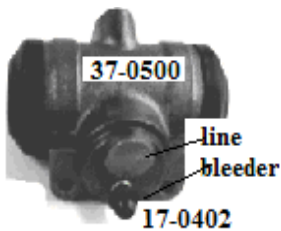

37-0500

17-0402



45-0134

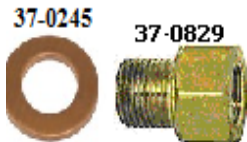

37-0245

37-0829

### Wheel Cylinder Overhaul kits- includes cups, springs & adjusters

37-0204-3/16	1 3/16 w/ huck style brakes 1936-1950 1/2 ton, 1936-1945 3/4 ton with smaller 11 inch brakes. "rear"	36-50	\$29.95
37-0204-1/4	1 1/4 w huck style brakes-1936-1950 1/2 ton and 1936-1952 3/4, 1, 1 1/2, and 2 ton."front"	36-52	\$34.95
17-0036	1 1/8 " bore		\$20.95
17-0046	1 " bore		\$11.95
37-0054	1 1/4 " bore		\$29.95
37-0038	1 3/8 bore (1.375)		\$36.95

### Wheel Cylinder Cups

37-0124	1 1/8 cup size	each	\$1.25
37-0138	1 3/8 cup size---	each	\$5.00
37-0125	1 1/4 cup size	each	\$3.95

### Wheel Cylinder Push Rod

37-0050		each	51-72	\$6.95
---------	--	------	-------	--------

### Bleeder Screw

17-0402	3/8 head 3/8 x 24	each	47-72	\$1.65
---------	-------------------	------	-------	--------

### Brake Shoe Guide Plate

37-0051	1/2 & 3/4	each	51-87	\$9.95
---------	-----------	------	-------	--------

### Hydraulic Brake Light Switch

45-0134	w/ adaptors & 3/16 line fittings & adaptors--closed circuit @ 45PSI			\$32.95
45-0134-S	switch only			\$18.60

### Master Cylinder line adaptor

37-0829	5/16 inverted male w/ 1/4 female includes brass washer & 3/16 & 1/4 line fitting			\$7.95
---------	----------------------------------------------------------------------------------	--	--	--------

### Washer-master cylinder adaptor

37-0245	3/4 OD-.1/2 IN			\$2.25
---------	----------------	--	--	--------

*Bill's Truck Shop*

Phone (905) 725-3460 / (905) 725-2022 / (905) 404-2302

# Brakes

Due to the fluctuation of the Canadian and American dollars call for current prices

# Group 37

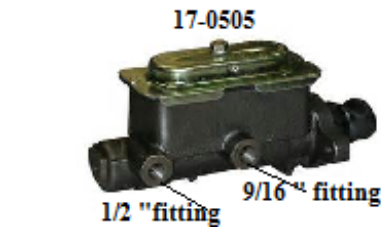
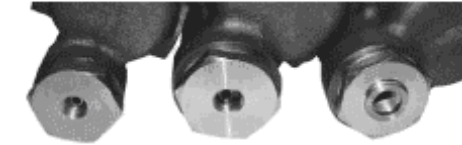
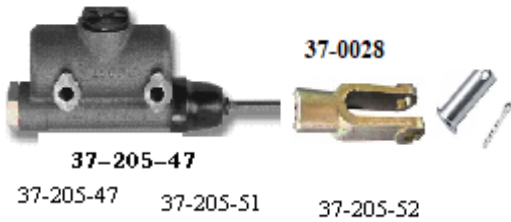

### Master Cylinder

	Year	New
37-205-47 1/2 ton w/ 1 7/16 end cap fitting w/ direct brake line fitting 1" bore	47-50	\$149.95
37-205-51 1/2 ton w/ 1 1/2 end cap w/ direct line application 1 1/8" bore	51-51	\$159.95
37-205-52 1/2 ton w/ 1 1/2 end cap w/ block fitting application 1 1/8 bore	52-55	\$179.95
Master cyl # 37-205-52 can use on all above w/ correct adapter for lines 1 1/8 bore		
37-206-7 48-51 3/4T-47-52 1 T-47-55 1 1/2 T & 2-2 1/2T - w/ direct brake line fitting 1 1/4 bore	47-55	\$249.95

### Master Cylinder Rebuild Kit

37-0003 1 bore	36-51	\$44.95
37-0146 1 1/8 bore	51-59	\$59.95
37-0033 1 1/4 bore -3/4 & 1 ton	36-52	\$49.95

### Master Cylinder Boot

10-0504-MB w/ manual brakes	47-72	\$7.95
-----------------------------	-------	--------

### Master Cylinder Fill Cap

37-0211 1 1/4 OE metal w/gasket	40-59	\$34.95
37-0211-A 1 1/4-plastic w/ gasket	40-59	\$21.95
37-0211-B 1 9/16	47-59	

**Master Cylinder Adapter kit-** a great upgrade to dual master for -includes hardware & instruction-if pedal shaft bushing are worn they MUST be replaced

37-2MCA	47-54	\$199.95
---------	-------	----------

**Master Cylinder – new 1" bore dual master for adapter kit**

17-0505 w/ drum brakes –see next page for brake line fittings <b>confirm your pipe size</b>		\$109.95
17-5246 master cylinder 1 1/8 (1.125)bore & deep bush rod for 3/4 ton up trucks when converting to dual master		\$159.95

*Bill's Truck Shop*

Phone (905) 725-3460 / (905) 725-2022 (905) 404-2302

# Brakes

Due to the fluctuation of the Canadian and American dollars call for current prices

Group 37



37-0759

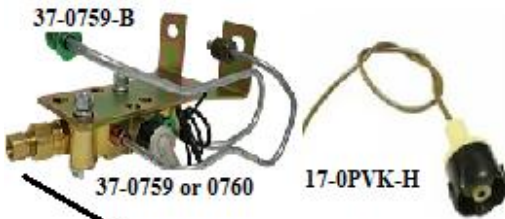

37-0759-B

37-0759 or 0760

17-0PVK-H



17-0038  
17-0016  
17-0020



36-0PCH

## Harness-proportioning valve switch

17-0PVK-H replacement harness w/ socket

\$12.95

## Master Cylinder w/ prop valve & bracket-when installing updated master under cab w/booster

37-0759 disc-drum prop valve w/ lines & bracket

47-59

\$179.95

37-0760 disc-disc prop valve w/ lines & bracket

47-59

Bracket kit w/o master cylinder

37-0759-B includes disc-drum valve,,lines,harness

47-59

\$169.95

## Prop valve rear fitting

17-0038--Fitting--9/16-18 inverted male to 3/8-24 female

\$6.99

17-0016 Fitting--9/16-18 inverted male to 7/16-24 female

\$6.95

17-0020 Fitting--9/16-18 inverted male to 1/2-20 female

\$6.95

## Brake Booster & PCV Hose

36-0PCH 3/8 x 35" long w/ clamps

\$24.95

## Universal brake booster

45-0DD8 8" dual diaphragm zinc plated

\$169.95

*Bill's Truck Shop*

Phone (905) 725-3460 / (905) 725-2022 / (905) 404-2302

# Brakes

Due to the fluctuation of the Canadian and American dollars call for current prices

# Group 37

37-210-E



37-0210-RS

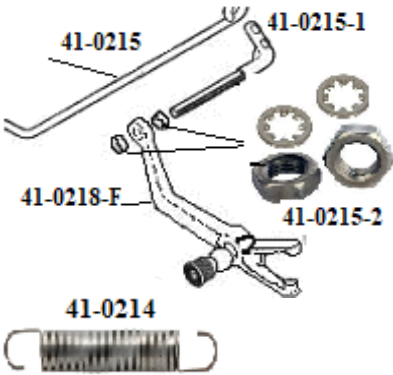

**Brake Pedal Return Spring** w/ 12" extension

37-0210-RS @ master cylinder 47-59 \$9.50

37-210-E 9" extension 47-55 \$4.95

**Clutch Pedal Return Spring @ clutch offset rod**

41-0214 47-59 \$5.95

**Clutch Linkage Rod @ pedal arm**

41-0215 47-59 \$17.95

**Clutch Linkage Offset Adjust Rod @ fork**

41-0215-1 47-59 \$27.95

**Nuts-Jam nut for clutch adjust rod-pr**

41-0215-2 pair of adjusting nuts w/ washers 47-59 \$2.95

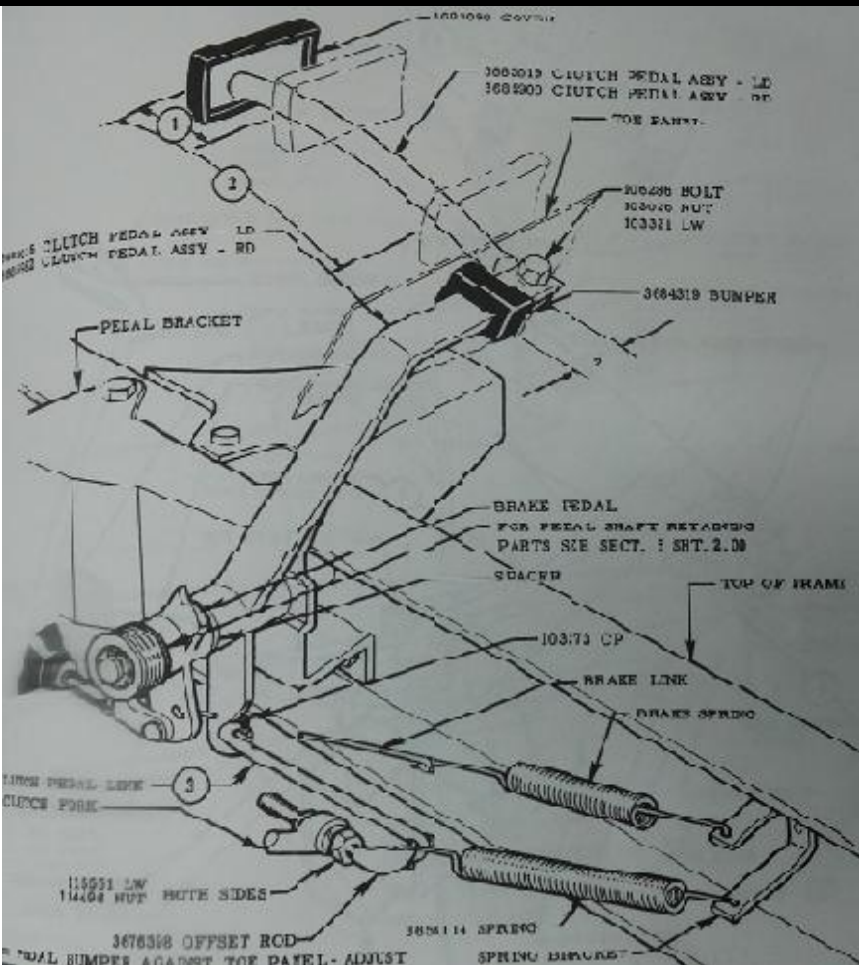

# Brakes

Due to the fluctuation of the Canadian and American dollars call for current prices

Group 37

37-0243

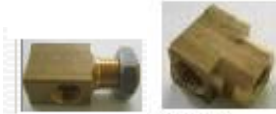

37-0247

37-0248



37-0203-B



37-0203-BB

3/16 pipe  
1/2 dia  
20 TPI



1/4 pipe  
9/16 dia  
18 TPI



37-0594



37-0248



37-0471



37-0476

tube OD 3/16-3/8-24 thread

## Brake Hose Gasket 7/16 ID

			Year	New
37-0243	7/16	each		\$3.25
37-0795	3/8 ID	each		\$1.25

## Brake Line Division Block

37-0247	brake line "T" on R frame rail-secured w/ nut	51-57	\$38.95
---------	-----------------------------------------------	-------	---------

## Rear Axle Division block

37-0248	38-70 Rear flex hose splitter block- secures to diff housing bracket w/ clip - flex line 7/16-20 on one side and 3/8-24 on the other 2 sides NOT 53 & 54	38-70	\$29.95
37-0249	Rear axle block fitting 1/4 line	36-65	\$34.95

## Wheel Cylinder Block- @ rear wheel cylinders between lines-use original bolt to secure

37-0203-B	36-50 1/2---51-53 3/4 to 2 ton---60-63 3/4 to 1 ton	each	36-50	\$29.95
-----------	-----------------------------------------------------	------	-------	---------

## Wheel Cylinder Block Bolt

37-0203-BB	includes 2 brass washers	36-50	\$17.95
------------	--------------------------	-------	---------

## Brake Fitting-oversize

37-03025	( blue ) 1/4 pipe-9/16 dia-18 threads per inch	\$3.50
37-03026	( gold ) 1/4 pipe-1/2 dia-20 threads per inch	\$3.50
37-03023	( green ) 3/16 pipe-1/2 dia-20 threads per inch	\$2.00
37-03024	( olive ) 3/16 pipe 9/16-18 threads per inch	\$3.50

## Plug Fitting

37-0594	1/4 brass plug -C360 inverted flare	\$1.98
37-0595	5/16 brass plug--C360 inverted flare	

## Tube Nut

37-0013	1/4 tube nut inverted flare-7/16 thread x 24 threads per inch	\$1.00
37-0010	3/16 tube nut inverted flare-3/8 thread x 24 threads per inch 7/16 socket	\$0.50
37-0000	3/16 tube nut inverted flare-3/8 thread x 24 threads per inch 3/8 socket	\$0.80

## Rear Axle Division block

37-0248	secures to diff housing bracket w/ clip to split ( 3/16 ) brake lines 1/2 ton NOT 53 & 54	51-66	\$29.95
---------	-------------------------------------------------------------------------------------------	-------	---------

## Division Block w/ mount bracket ( universal )

37-0476	3/16 tube 3/8-24 thread	\$29.95
---------	-------------------------	---------

37-0471	"T" fitting 3/8-24 3/16 lines	each	\$10.95
---------	-------------------------------	------	---------

*Bill's Truck Shop*

Phone (905) 725-3460 / (905) 725-2022 / (905) 404-2302

# Brakes

Due to the fluctuation of the Canadian and American dollars call for current prices

Group 37

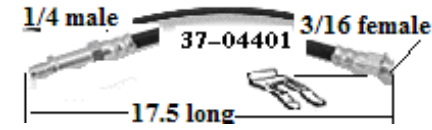
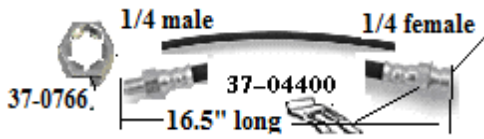

**Brake Hose** (each) 47-50 has 1/4 pipe /51-55 3/16 pipe fitting-----all hoses approx. 17" long  
04401 requires nut to secure to frame

		<u>Year</u>	<u>New</u>
37-04400	1/4 line- 1/2 ton front-each	47-50	\$29.95
37-04401	3/16 line - 1/2 ton front-rear-each	37-55	\$36.95
37-04400	1/4 line- 1 ton front-each	47-52	\$29.95
37-04401	3/16 line- 1/2-3/4 ton-1 ton front-each	53-55	\$36.95
37-04400	1/4 line 1/2 ton rear -each	47-55	\$29.95
37-04400	1/4 line 3/4 ton rear-each	47-55	\$29.95

**Hose ID-** #04401 extended @ wheel cylinder end w/ "U" clip to secure /// use 04400 "U" clip to secure

### Brake Hose Lock Nut

37-0766	secures hose # 04402 to frame	47-59	\$1.25
---------	-------------------------------	-------	--------

### Brake Hose Gasket 7/16 ID

37-0243	brass seal & cylinder	each	36-87	\$3.25
---------	-----------------------	------	-------	--------

### Brake Hose Clips

37-0215-C		each		\$1.65
-----------	--	------	--	--------

### Brake Line Division Block

37-0247	brake line "T" on R frame rail-secured w/ nut	51-57	\$38.95
---------	-----------------------------------------------	-------	---------

### Rear Axle Division block

37-0248	secures to diff housing bracket w/ clip to split (3/16) brake lines 1/2 ton NOT 53 & 54	51-66	\$29.95
---------	-----------------------------------------------------------------------------------------	-------	---------

**Wheel Cylinder Block-** @ rear wheel cylinders between lines-use original bolt to secure

37-0203-B	36-50 1/2---51-53 3/4 to 2 ton---60-63 3/4 to 1 ton	each	36-50	\$29.95
-----------	-----------------------------------------------------	------	-------	---------

### Wheel Cylinder Block Bolt

37-0203-BB	includes 2 brass washers	36-50	\$17.95
------------	--------------------------	-------	---------

### Brake Fitting-oversize

37-03025	( blue ) 1/4 pipe-9/16 dia-18 threads per inch	\$3.50
37-03026	( gold ) 1/4 pipe-1/2 dia-20 threads per inch	\$3.50
37-03023	( green ) 3/16 pipe-1/2 dia-20 threads per inch	\$2.00
37-03024	( olive ) 3/16 pipe 9/16-18 threads per inch	\$3.50

### Clamp-insulated

37-0315	3/8 w/ hdw	pair	\$3.75
---------	------------	------	--------

*Bill's Truck Shop*

Phone (905) 725-3460 / (905) 725-2022 (905) 404-2302

# Brakes

# HUCK BRAKE S

Group 38



**Retainer/clip-stud lock-fits cars and trucks**

NEW

37-0200-S	small-approx 7/16 ID	each	36-50	\$2.25
37-0200-L	large - approx. 9/16 ID	each	36-50	\$2.25
37-02SL	kit 4 large and 2 small (6 pcs) does 1 axle		36-50	\$12.95

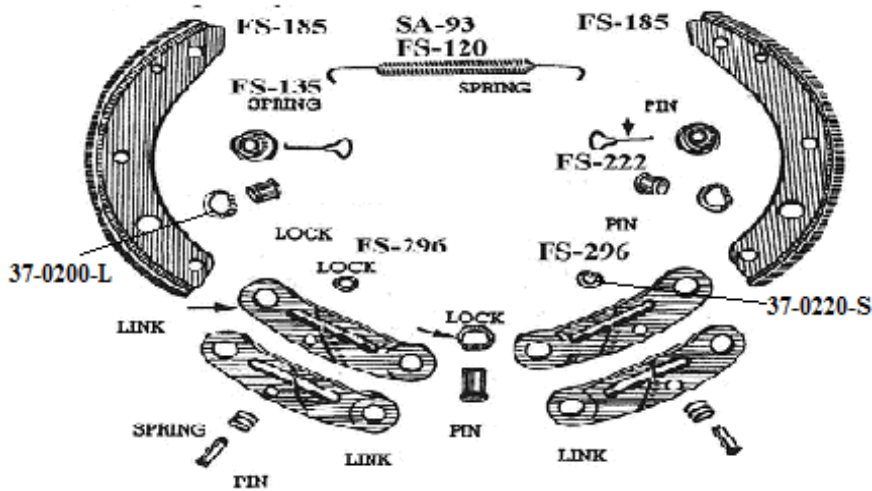

# Brakes

Due to the fluctuation of the Canadian and American dollars call for current prices

Group 38



		<u>Year</u>	<u>New</u>
<b>Brake Shoe Return Spring</b>			
38-0201-FR	½ ton front & rear-each	36-50	\$5.95
38-0201-FR	¾ ton front each	37-52	\$4.95
38-0202-FR	46-52 ¾ rear & 36-52 1 - 1 ½ & 2 ton front and rear	5/8 inch x 7 9/16 each	36-52 \$22.95
<b>Brake Shoe Hold-Down Spring (each wheel)</b>			
38-204	½ Ton, Ft. or R, pair	36-50	\$9.95
38-0138	¾ ton up -w/ 2 ¾ pin 12" shoes and up/ ft and rear per axle	51-87	\$14.95
<b>Brake Spring Kit -hold down &amp; return per axle</b>			
38-0206-FR	front & rear axle 1/2 ton	51-63	\$18.95
<b>Brake Adjuster Screw w/o self adjusting brakes</b>			
38-0208	fits L or R front & rear	each	51-62 \$16.95
<b>Backing Plate Adjuster plug</b>			
38-0250	ft or rear	each	36-87 \$1.95
<b>Parking Brake Cable.</b>			
38-210-OEWR	original style - <b>wire wrapped</b> - ½ ton-47-51 requires reusing original brake arm cable adaptors-or new -#17-0210-C	47-55	\$89.95
38-210-OE	original style - <b>rubber wrapped</b> ½ ton-47-51 requires reusing original brake arm cable adaptors-or new -#17-0210-C	47-55	\$44.95
38-210-3-----	47-55 Chev ¾ & 47-55 GMC long step ½ approx 49" long w/ inline grease fitting	47-55	\$99.95
38-210-4	rear brake cable 1 ton up- w /huck style brakes-total cable 64"-casing 24" threaded rod 6" long----- special order	47-55	\$125.00
<b>Connector-park brake cable</b>			
17-0210-C	w/ huck style brakes	each	36-50 \$24.95
38-210-N	- <b>Rear brake cable</b> - when replacing w/ new car style rear end original style lock on frame bracket ( bracket hole must be drilled to ½ " ) w/ clip style for round hole on backing plate -total cable 2 " longer/threaded rod 2" longer see picture	47-55	\$125.00

## Bill's Truck Shop

Phone (905) 725-3460 / (905) 725-2022 (905) 404-2302

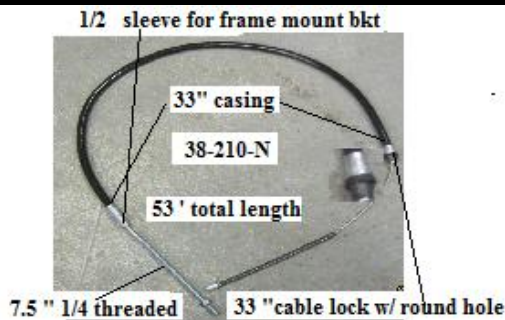

# Brakes

Due to the fluctuation of the Canadian and American dollars call for current prices

Group 38

Year      New



37-230-R

-remove bolt-& close to 1/16 gap-drill hole to 9/16"  
-casing 30 1/2" -total cable length 45"



-1/2" OD  
-threaded rod 6 1/2"

-round style retainer for backing plate  
-spring may require shorting on shoe size

### Brake Cable Yoke Ends

37-0027	2 1/2" long w/ pin	each	5/16 NF	47-55	\$19.95
38-222-4	4" long w/ hdw	5/16 NF for			
	long bed trucks	1/2 / 3/4 & 1 ton	each	47-55	\$24.95



4"  
38-222-4

### Pin-cable yoke end w/ cotter pin

38-0435	5/16 x 1 1/4			47-55	\$1.45
---------	--------------	--	--	-------	--------



37-0027

2 1/2"

38-0435

### Parking Brake Cable Boot

37-0214		each		47-59	\$4.25
---------	--	------	--	-------	--------

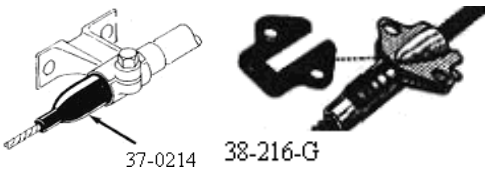

37-0214

38-216-G

### Gaskets-Parking brake cable backing plate

38-216-G		pair		47-55	\$4.95
----------	--	------	--	-------	--------

*Bill's Truck Shop*

Phone (905) 725-3460 / (905) 725-2022 / (905) 404-2302

# Brakes

Due to the fluctuation of the Canadian and American dollars call for current prices

Group 38



### Brake Drum (each)

		<u>Year</u>	<u>New</u>
37-0215	36-50 front brake drum ½ ton w/ huck style brakes and 1936-45 ¾ ton rear 11 x 2 1/4	36-50	\$239.95
37-0216	36-50 rear brake drum ½ ton- w/ huck style brakes & 37-42 ¾ ton each 11 X 2 1/4	36-50	\$199.95
37-0217	front or rear 11x2" each	51-70	\$79.95
37-0200	front brake drum 12 x 2 ¾ and 1 ton	53-62	\$169.95

**Fits 64-75 1/2-3/4 ton rear 2 and 4 wheel drive, 64 1/2 ton 2 wheel drive front, and 65-75 1/2 ton 2 and 4 wheel drive front.-can use to upgrade to self adjusting brakes from 51-63**

17-0508	Brake Adjuster kit w/ 11 brakes L side	64-75	\$29.95
17-0509	Brake Adjuster kit w/ 11 brakes R side	64-75	\$29.95
17-0444	Park brake arm retainer clip w/ tension washer 2 pair /both sides	60-91	\$2.95
17-0444-SK	Stud- park brake arm to shoe 2 pins w/hdw		\$9.95

**These park arms used the stud w/ C clip to secure to the shoe ( not the bolt w/nut )**

17-0701	Park brake cable arm-left ½ ton	64-91	\$34.95
17-0702	Park brake cable arm-right ½ ton	64-91	\$34.95

### Park Brake Bar

37-0745	51-77 Strut-park brake 1/2-ton approx 7 ½ long w/ 11 brakes	51-77	\$11.95
---------	-------------------------------------------------------------	-------	---------

### Park Brake Bar Spring

37-0744	@ cross bar & front shoe each	51-87	\$2.95
---------	-------------------------------	-------	--------

### Adjuster arm Spring

17-0507	each		\$3.95
---------	------	--	--------

*Bill's Truck Shop*

Phone (905) 725-3460 / (905) 725-2022 / (905) 404-2302

# Brakes

Due to the fluctuation of the Canadian and American dollars call for current prices

# Group 38

Year      New      Used

### Parking Brake Kit

Everything need to install a NEW style push peddle park brake w/ OE or replacement rear end-includes pedal assembly, ft & 2 rear cables, ft cable support and threaded rod w/ joints to rear cable cross support

38-2200-K      47-55      \$449.95



38-0219-HS

### Park Brake Handle Spring w/hand brake

38-0219-HS with brake @ trans      29-59      \$13.95

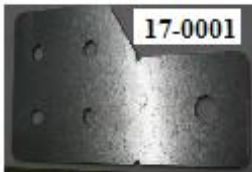

17-0001

### Brake Cable Support

17-0001 11 gauge galvanized steel-can be used to anchor park cables on frame-bend support to each application-9/16 cable hole-may require enlarging/includes hdw-bend bkt to fit application

\$18.95

## Bill's Truck Shop

Phone (905) 725-3460 / (905) 725-2022 / (905) 404-2302



38-2200-K

# Chassis

Due to the fluctuation of the Canadian and American dollars call for current prices

# Group 38



### Wheel Studs

38-230-S	7/16-20	each	47-50	\$3.25
38-0230-S	7/16-20 X 1 3/8	each	51-70	\$3.95

### Wheel Nut

38-0230-N	7/16-20	each	36-70	\$4.25
38-0144	7/16-20 13/16-1 3/8 deep/chrome	each		\$2.25

### Spindle Nut and Washer

15-0193	1/2 ton	each	41-87	\$14.95
---------	---------	------	-------	---------

### Spindle Dust Cap

17-0977	approx 2 3/32 " OD	1/2 ton & some 3/4 ton check dia	each	47-62	\$9.95
17-0977-1		1 ton up			

### Wheel Bearings w/race-front-please order all parts after checking # stamped on parts

38-0325 -I	inner wheel bearing- ball type-	1/2 ton	38-59	\$79.95
38-0325-O	outer wheel bearing-ball type-	1/2 ton	38-61	\$129.95
38-0325-6I	inner wheel bearing- ball type-	3/4 & 1 ton	36-52	Inquire
38-0325-6O	outer wheel bearing-ball type	3/4 & 1 ton	36-52	Inquire
38-0325-3I	inner wheel bearing- ball type-	3/4 & 1 ton	53-59	Inquire
38-0325-3O	outer wheel bearing-ball type	3/4 & 1 ton	53-59	Inquire

### Wheel Bearing Kit-upgrades to tapered roller bearings and includes seals- 1/2 ton

38-04759-BK			47-59	\$224.95
38-04759-S				

Grease seal-replacement for bearing kit	each	47-59	\$13.95
-----------------------------------------	------	-------	---------

### Grease Seal-front

38-0326	1/2 ton 2 wh drive	each	38-59	\$24.95
38-0669	3/4, 1 and 1-1/2 ton	each	35-59	\$27.95

*Bill's Truck Shop*

Phone (905) 725-3460 / (905) 725-2022 / (905) 404-2302

# Suspension

Due to the fluctuation of the Canadian and American dollars call for current prices

# Group 39



39-205-F



39-0227

39-0225

39-0221



## Shackle Kit Threaded Pins, bushings, side plates, seals and all mounting hardware

		<u>Year</u>	<u>New</u>
39-201F	½ ton - ¾ ton, front w/ 1 ¾" spring	47-55	\$89.95
39-301-FR	40--55 1-, 1 ½-, 2 ton front & 55-59 -½-, ¾ ton w/2 " spring front and rear 2 1/8 eye to eye	40-57	\$94.95
39-201R	½ ton, rear w 1 ¾" spring	34-55	\$89.95
39-202R	¾ -1 ton, rear-pins & bushing -w/ cast shackle 2 pins w/ bushings per side	47-55	\$119.95

## Rear Spring Shackle Support

39-0203-S	cast iron support w/ new bushing- 33-68 ¾ - 1 ton and 33-59 1 ½ - 2 ton ---w 2 ½ wide spring each-----special order	33-68	\$124.95
-----------	---------------------------------------------------------------------------------------------------------------------	-------	----------

## Spring Eye Bolt & Bushing @ fixed end of spring

39-204-FR	front ½ & ¾-rear ½ ton w 1 ¾" spring each	34-55	\$49.95
39-205-F	1 & 1 ½ ton w/ 2 "spring -grease fitting on nut end each	41-55	\$69.95
39-205-R	rear ¾ -1 ton w/ 2 " spring-grease fitting on thread end w/ lock pin each	37-55	\$59.95

## Tapered Lock Pin w/nut

39-0205-P		47-59	\$24.95
-----------	--	-------	---------

## Shackle Rubber Seals (each)

39-0206		34-66	\$1.50
---------	--	-------	--------

## King Pin Set -pins, bushings, shims, end caps, & lock pins

OS. 010 oversize /STD standard size (check before order)  
OS is to compensate for "I" beam

39-208-53OS	.910 shaft dia. 5.312 / .010 over size pin ½ ton	41-55	\$139.95
39-208-53ST	.866 X 5.312 pin ½ ton & 41-45 ¾ & 1 ton	41-55	\$199.95
39-208-1-47ST	0.921 pin OD 46-52 ¾ -1 ton & 41-50 1 ton	46-52 46-50	\$199.95
39-208-1-53ST	¾ & 1 ton	53-55	\$199.95
39-0208-41OS	41-50 1 ½ , 46-52 ¾, 1 ton	41-52	

## Grease/Zerk Fittings

39-0225	1/8-28 Pipe thread 45 degree-each		\$2.95
39-0225	1/8-28 Pipe thread-straight---each		\$2.95
39-0221	¼ -28 Pipe thread-straight---each		\$1.95

*Bill's Truck Shop*

Phone (905) 725-3460 / (905) 725-2022 / (905) 404-2302

# Suspension

Due to the fluctuation of the Canadian and American dollars call for current prices

# Group 39



39-210-R



39-210M-R



39-210M-F



39-210M-F

39-210A-F



39-0004-FR

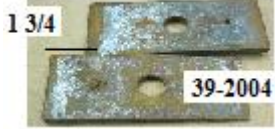

39-2004



39-0211

**Alignment Solution for Installing a Late Model Rear End in a 1947-1954 Pick Up**  
 On the original rear end, the spring centerbolt is offset to the front of the spring by 2" to 3". If you install a modern rear end (with an open driveshaft) and retain the original springs, the wheels will end up offset forward (inside) of the original wheel openings in the fenders. To correct this problem, remove the original springs and reverse them end to end (front to back) as they are the same on both ends. This will bring the spring centerbolt to the rear of the axle and place the new rear end in the center of the fender wheel openings.

### Want to lower your truck

-remove leafs to 7 on front and 7-8 on rear and use the (1") shorter ft shackles on rear -an inexpensive way to lower the overall height of the truck by 2 to 3 "

**Main Leaf Spring**-replace the main leaf only if bushing eyelets are broken or worn OR if leaf is broken- bushing not included

					<u>Year</u>	<u>New</u>
39-210M-F	front	1/2 ton only	each	47-55	\$139.95	
39-210M-R	rear	1/2 ton only	each	47-55	\$139.95	

### Main Leaf Assist Spring

39-210A-F	2 <sup>nd</sup> leaf w/ curl at spring eye @ shackle			47-55	\$95.00
-----------	------------------------------------------------------	--	--	-------	---------

### Pinon & Caster Angle Shim set--Aluminum

39-0004-FR	2 " wide 4 deg w/ bolt-ft caster or rear pinion angle	47-54 ¾ ton & 55-59 ½-¾ ton	47-59	\$54.95
------------	-------------------------------------------------------	-----------------------------	-------	---------

39-0004-2	caster/pinion	1/34 " wide 2 deg pr w/ bolts	39-54	\$48.95
-----------	---------------	-------------------------------	-------	---------

39-0004-4	caster/pinion	1 ¾ " wide 4 deg pr w/ bolts	39-54	\$54.95
-----------	---------------	------------------------------	-------	---------

### Leaf Spring Center Bolt w/nut ----- confirm size

39-0211-3/8	3/8 x 7 "	each	47-72	\$5.95
-------------	-----------	------	-------	--------

39-0211-5/16	5/16 x 5 "	each	47-72	\$5.95
--------------	------------	------	-------	--------

## Bill's Truck Shop

Phone (905) 725-3460 / (905) 725-2022 / (905) 404-2302

# Suspension

Due to the fluctuation of the Canadian and American dollars call for current prices

# Group 39

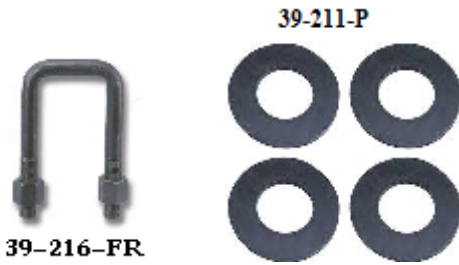

### Rear Axle Spring Seat Side Pads

		Year	New
39-211-P	set of 4	47-49	\$6.95

### U-Bolts w / nuts ----- 5 " tall

39-216-FR	for 1 3/4 " spring front or rear	each	40-55	\$16.95
-----------	----------------------------------	------	-------	---------



**Shock Absorber** –cylinder type gas shocks-can also be installed on 47-49 trucks w/ 50-55 w/ brackets  
Also lower bkts require replacing as they are not the correct angle for cylinder shocks -

39-213-F	gas /front 1/2 -3/4 & 1ton	each	47-55	\$59.95
10.250 short-16 3/4	extended			

39-213-R	gas/rear 1/2 & 3/4 ton	each	47-55	\$69.95
12.50 short—21.250	extended			

When installing on 3/4 & up where shock mount on rear end -shock requires lower sleeve and bolt



### Shock bushing kit- 2 bush , 2 washers , 1 nut

39-0134	1 end			\$5.95
---------	-------	--	--	--------



**Shock Absorber Mount Brackets** w/cylinder shocks-can also be used on 47-48 to upgrade shocks to cyl type  
Also lower bkts require replacing as they are not the correct angle for cylinder shocks

39-215	upper left or right/front or rear -each	47-55	\$49.95
--------	-----------------------------------------	-------	---------

### Lower shock brackets are FLAT w/ lever action shock

39-215-47FLR	lower front right w/ lever shock	47-49	
--------------	----------------------------------	-------	--

39-215-47FLR	lower front left w/ lever shock	47-49	
--------------	---------------------------------	-------	--

39-215-FLR	OE style front lower – right	49-55	\$28.95
------------	------------------------------	-------	---------

39-215-FLL	OE style front lower – left	49-55	\$28.95
------------	-----------------------------	-------	---------

39-215-RL	rear lower - left or right w/ hdw	49-55	\$44.95
-----------	-----------------------------------	-------	---------



Bill's Truck Shop Phone (905) 725-3460 / (905) 725-2022 / (905) 404-2302

# Suspension

Due to the fluctuation of the Canadian and American dollars call for current prices

# Group 39



## Shock Absorbers-SINGLE Action Lever Style- rebuilt and painted ready to operate like new

		<u>Year</u>	<u>New</u>
39-214-RF	½ & ¾ ton right front	47-49	\$145.00
39-214-LF	½ & ¾ ton left front	47-49	\$145.00
39-214-RR	½ right rear	47-49	\$145.00
39-214-LR	½ left rear	47-49	\$145.00

## Shock Absorber Link w/ single action shocks- includes bushings ,pins and sleeves-hole to hole 8 ½ long

39-214-1	front	each	47-49	\$41.95
39-214-1	rear	each	37-49	\$41.95

## Shock Absorber Link w/ double action shocks

39-215-1	vertical rod at rear		37-49	\$29.95
----------	----------------------	--	-------	---------

## Shock Link Bushing Kit

39-214-B	2x bushing w/sleeves, pins w / single action shock		30-49	\$26.95
39-215-B	single rubber bushing-each		37-49	\$19.00
39-0215-BK	pair -bushing & washers w/ 7/16 pin style link	1 kit per shock	37-49	\$29.95

## Axle Bumper

39-218F	front 1/2 ton	each	40-55	\$13.95
39-0218	47-55 rear & 55-59 ft & rear	each	47-59	\$10.95
15-0560-BP	universal application axle/frame /control arm bumpers polyurethane 2" tall	pr		\$36.95

## Steering Drag Link-pitman arm to steering knuckle--- 12" stud to stud

39-223-47	½ - ¾ -1 & 1 1/2 ton		47-52	\$169.95
39-223-53	½ - ¾ -1 & 1/ 1/2 ton		53-55	\$209.95

## Tie Rod Repair kit and 41-52 drag link

39-0220-RK	½ - ¾ & 1 ton for both sides		29-59	\$44.95
------------	------------------------------	--	-------	---------

## Ball Stud-threaded installation type

39-225-P	(3/4 shoulder) on pitman arm		34-52	\$32.95
39-225-S	(5/8shoulder ) on end of steering arm		47-52	\$44.95
39-0225-2	( ½shoulder ) at tie rod end 1/2 ton -each		34-59	\$49.95

*Bill's Truck Shop*

Phone (905) 725-3460 / (905) 725-2022 / (905) 404-2302

# Steering

Due to the fluctuation of the Canadian and American dollars call for current prices

Group 39

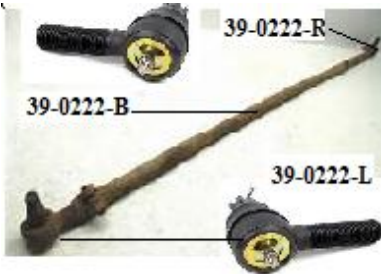
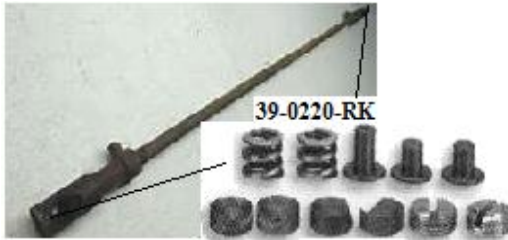
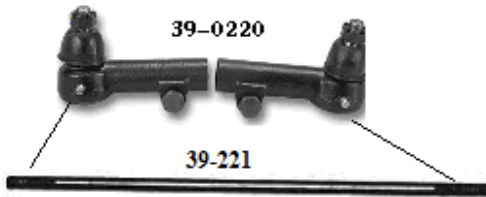

### Tie Rod Ends-----NEW style w/ solid male bar

39-0220 replacement type- pr 1/2 and 3/4 ton- requires solid treaded bar between wheels see # 39-221

Year New

34-59 \$95.95

### Tie Rod Link-solid bar with male treaded ends

Some tie rod links came w/ hollow tube -need to replace to solid bar type when upgrading to new style tie rod ends -threads on bar-**wire wheel sealer of threads before installing ends**

39-221 between wheels 1/2 ton 47-55 \$79.95

### Tie Rod Repair kit and 41-52 drag link

39-0220-RK 1/2 - 3/4 & 1 ton for both sides 29-59 \$44.95

### Tie Rod Ends ---- NEW style w/ hollow style w/ female bar 1/2 & 3/4--tapered shaft

39-0222-L left tie rod end 34-59 \$69.95

39-0222-R right tie rod end 34-59 \$69.95

### Tie Rod Cup Boot

39-0176 w/ 9/16 shaft diameter each \$5.95

39-0177 w/ 5/8 shaft diameter each \$5.95

### Grease Fittings

39-0225 large 1/8 pipe thread -straight pair \$2.95

39-0227 large 1/8 pipe thread - 45 deg pair \$7.95

*Bill's Truck Shop*

Phone (905) 725-3460 / (905) 725-2022 / (905) 404-2302

# Steering

Due to the fluctuation of the Canadian and American dollars call for current prices

Group 39



47-52



40-0056



5-0230-N

18-0311



40-0055



40-0149

40-202

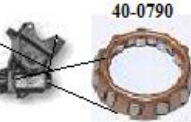

40-0790

41-0141



40-208-S



40-0001



40-201-1



40-2808

Year      New

### Pitman-Sector Shaft Seal

40-0055      47-72 w/ manual steering      37-72      \$19.95

### Pitman-Sector Bushing kit

40-0056      2 brass bushing w/ seal      37-72      \$69.95

### Pitman Shaft Nut w/ lock washer

40-0055-N      w/ manual steering box      37-72      \$4.00

### Steering Box –used sold as “AS IS “

Rebuilt columns do not include new upper bearing-  
#18-0311-confirm if required—includes 5-0230-N  
Grease packed during assembly-no lube required-tube  
length- top of box casting to top of tube-rebuilt require  
exchange core

40-208-47-3      3-speed-column shift      47-53      \$395.00

40-208-47-4      4-speed-floor shift      47-53      \$395.00

40-208-54-3      3-speed-column shift      54-55      \$395.00

40-208-54-4      4-speed-floor shift      54-55      \$395.00

### Steering Box Thrust Bearing (only) upper or lower

40-0790      41-59      \$44.95

### Steering worm gear w/ shaft

40-208-S      \$449.95

### Steering box- lower bearing w/ threaded adjuster

40-0149      41-59      \$109.95

### Steering Box -bearing w/ race -lower worm gear

40-0141      41-59      \$69.95

### Upper Column Bearing -

18-0311      with horn wire      47-59      \$94.95

### Steering Wheel Retaining Nut w/ washer

5-0230-N      47-72      \$1.95

### Steering Box Rebuild Kit Includes bearings w/race, bushings, gaskets , seal ,bearings and instructions

40-201-1      does not include ball bearing set      47-55      \$169.95

### Steering Box Bearing set

40-0001      60 pcs 9/32 steel ball bearings      \$34.95

### Steering Box Gasket set

40-0808      end cap & cover      41-46 & 55-59      \$9.95

40-2808      end cap & cover      47-55      \$7.95

*Bill's Truck Shop*

Phone (905) 725-3460 / (905) 725-2022 / (905) 404-2302



# Mounts-Engine-Trans-Body

# Group 40

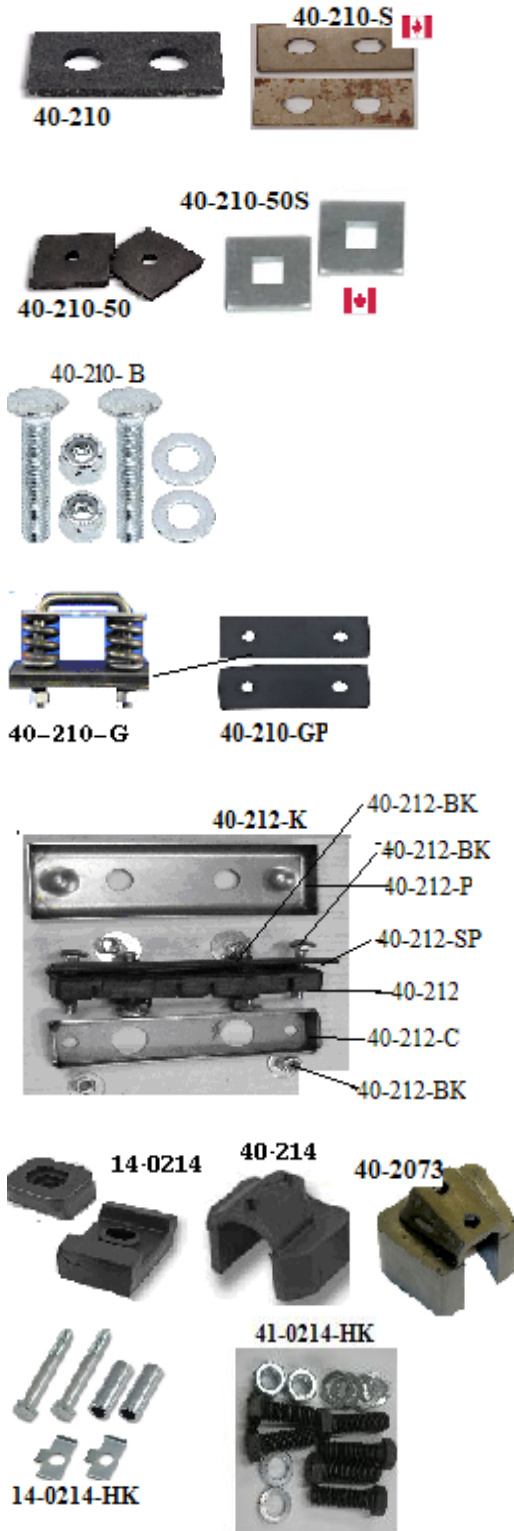





		<u>Year</u>	<u>New</u>
<b>Radiator Support Mounting Pads</b>			
40-210	1 pad w/ 2 holes---center mount	47-49	\$2.95
40-210-50	2 pads----- side / side mount pair	50-55	\$3.95
<b>Radiator Support Shim-helps correct fit sheet metal alignment</b>			
40-210-S	1/8 thick pair	47-49	\$5.95
40-210-50S	1/8 thick pair	50-55	\$5.95
<b>Radiator Support Bolt Kit</b>			
40-210- B	pair	47-55	\$3.95
<b>Radiator Support Mount Assembly-GMC</b>			
40-210-G	w/ u- bolt, springs, plates, pads	47-55	\$69.95
<b>Radiator Support Pads-GMC</b>			
40-210-GP	pair	47-53	\$4.00
<b>Front Motor Mounts Pad</b>			
40-212		32-55	\$26.95
<b>Front Motor Mount Pad Shield</b>			
40-212-P		32-55	\$14.95
<b>Ft Engine Mount Bolts—4 bolts w/hdw</b>			
40-212-BK	2 x 3/8 @ cushion to frame (2 bolts washer& lock nut ) and 2 x 7/16 at engine to cushion plate	32-55	\$5.95
<b>Ft kit-Chev</b>			
40-212-K		32-55	\$99.95
<b>Rear Motor Mounts</b>			
40-214	each	37-53	\$29.95
14-0214	1 upper & 1 lower- also 54-59 w/auto trans	54-72	\$36.95
40-2073	1937-1947 Chevrolet).(1939-1959 GMC) (1947-1953, 3/4, 1, 1 1/2, 2 ton Chevrolet and GMC)..(1952 -1953 GMC with Hydromantic Trans (wedge shape-3 " wide) each	37-59	\$29.95
<b>Rear Motor Mount Install hdw kit</b>			
41-0214 HK	for both sides	37-53	\$9.95
14-0214-HK	sleeves/bolts & locks 6 pcs 2 sides	54-95	\$26.95

*Bill's Truck Shop*

Phone (905) 725-3460 / (905) 725-2022 / (905) 404-2302

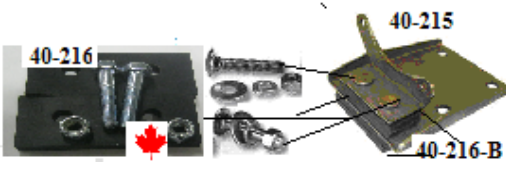
# Mounts-Engine-Trans-Body

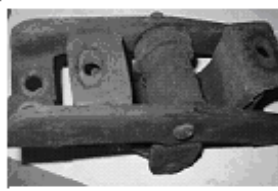
# Group 40

		<u>Year</u>	<u>New</u>
	<b>Rear Transmission Mount</b> 3 speed trans only		
	40-215 complete steel /rubber bracket assembly	48-55	\$169.95
			
	40-216-B upper brace w/ lower plate	47-55	\$49.95
	<b>Rear Transmission Mount Repair Pads w/Bolts</b>		
			
	40-216 2 pads/2 bolts	47-55	\$10.95
			
	<b>Cab Mount Kit</b> With hardware		
			
	40-227-47 w/ center mount hdw & side bumpers	47-48	\$139.95
	40-227-49 w/ side shackle -over haul kit	49-55	\$39.95
	40-227-49S cab to frame shackle set		
			
	<b>NOTE-</b> the frame bracket mount holes could be vertical or on an angle—may require frame drilling	49-55	\$239.95
	40-227-P panel, suburban, canopy express	47-55	\$72.95
			
	<b>Shims</b>		
	40-227-49S	49-55	

*Bill's Truck Shop*

Phone (905) 725-3460 / (905) 725-2022 (905) 404-2302

# Engine Parts

# Group 41

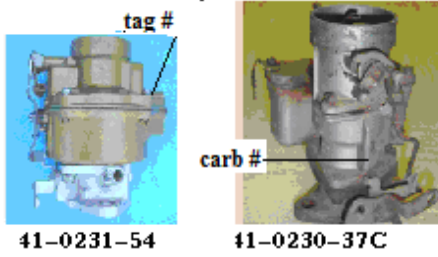

41-0064      41-0063



41-0111



41-0158



41-0231-0      41-0231-0G

**INFO-before ordering-confirm carb w/ tag# / carb # and or visual ID carb kits are NOT RETURNABLE also carb mount stud spacing --- - kits do not include float-----NON returnable**

### Carburetor Rebuild kit

		<u>Year</u>	<u>New</u>
41-0111	Carter YF--- 32-62 Chev car & truck /54-55AMC 50-53IHC /50-67Jeep /51-54 Kaiser-Nash	32-62	\$63.50
41-0063	Carter W-1 --- 32-48 Chev car & truck / 47 Kaiser	32-48	\$169.65
41-0065	Carter W 1---49-49	49-49	\$102.95
41-0064	Carter W-1--- 41-52 Chev car & truck	41-52	\$127.65
41-0158	Rochester 6 cyl	50-62	\$69.95

### Carb Float

41-0093	Carter YF---37-67 Chev & GMC truck / AMC 54-76 Checker Motors / 64-65 Chev car / 37-67 Ford & Mercury / 67-74 Ford truck / 68-82 International / 50-53 Jeep / 50-76 Kaiser & Frazer 51-54 Nash / 55 Olds / 66-67 Opel ( Buick) / 68 72 Pontiac / 64-67 Studebaker		
41-0095	Rochester w/ 6 cyl	41-62	\$34.95

### Carburetor Insulation Plate

41-0231-0	216/235 w/ -2 3/4 stud spacing	37-53	\$11.95
41-0231-1	235 w / 2 15/16 stud spacing	54-62	\$11.95

### Carburetor Base Gasket

41-0231-0G	216/235 w/ 2-3/4 stud spacing	37-53	\$6.95
41-0231-G	235 gasket - 2 15/16 stud spacing	54-62	\$5.25

*Bill's Truck Shop*

Phone (905) 725-3460 / (905) 725-2022 / (905) 404-2302

# Engine Parts

# Group 41



41-201-48



41-0201-54



41-0201-49



41-203

41-203-N



41-0310



41-0208

41-208

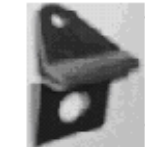

41-208-B



41-0211-S



41-0211-R

41-0211-K

41-0211

41-0211-L

## Oil Filler Cap----see previous page for info

		<u>Year</u>	<u>New</u>
41-201-48	fits on breather pipe-	37-48	\$12.95
41-0201-49	on valve cover -twist on / not vented w/ vented valve cover	49-78	\$7.50
41-0201-54	on valve cover/vented 6 cyl w/ non vented valve cover	54-67	\$12.95

## Valve Cover Grommets

41-203-G	w/ 2 center bolts	pair	47-53	\$4.95
----------	-------------------	------	-------	--------

## Valve Cover Nuts- Acorn style-stainless steel

41-203-N	34-53 Chev & 39-59 GMC	pair	34-59	\$6.95
41-203-NS	34-53 Chev & 39-59 GMC	stain-steel/pair	34-59	\$9.95

## Accelerator Return Spring

41-208	6 cyl	47-49	\$14.95
41-0208	6 cyl	50-59	\$9.95

## Accelerator Spring Mount Bracket

41-208-B	secures to oil pan for spring	41-53	\$17.95
----------	-------------------------------	-------	---------

## V8 Throttle Linkage-for converting to V-8

41-0310	47-52 require 53-57 gas pedal	47-59	\$89.95
---------	-------------------------------	-------	---------

## Spring-Starters pedal return

41-0211	47-59	\$5.50
---------	-------	--------

## Tension spring kit-@ starter pedal rod

41-0211-K	47-59	\$2.95
-----------	-------	--------

## Spring-starter pedal shaft anti rattle spring

41-0211-S	47-59	\$4.95
-----------	-------	--------

## Accelerator Swing Bolt on engine block

41-0209-S	37-49	\$24.95
-----------	-------	---------

*Bill's Truck Shop*

Phone (905) 725-3460 / (905) 725-2022 / (905) 404-2302

# Engine Transmission

# Group 41

Year      New



### Clutch Fork Ball Stud

41-0216-S      w/ 7 1/6 shaft—6 cyl only      38-59      \$19.95

41-0216-S1      with 3/4 shaft—V 8 only      55-72      \$39.95

### Clutch Fork /Ball Stud Spring clip

41-0217      38-72      \$14.95

*Bill's Truck Shop*

Phone (905) 725-3460 / (905) 725-2022 / (905) 404-2302

# CLUTCH

## Group 41



		<u>Year</u>	<u>New</u>
<b>Pilot Bushing</b>			
41-0440	fits 6 & 8 cyl	47-87	\$14.95
<b>Clutch Release Bearing</b>			
41-0086	6 cyl & most V8 1 7/8 long	38-75	\$69.95
41-0087	1 1/4 long	47-84	\$69.95
<b>Clutch Disc</b>			
41-0230-D	9 1/8 w/ 3 speed trans	38-53	104.00
<b>Clutch kit</b>			
41-0230	NEW 9 1/8" clutch w/ pressure plate Release bearing, pilot bushing & align tool all w/ 3 speed transmission w/6 bolt pressure plate	38-53	\$395.95
41-0049	NEW 11 clutch kit w/ 4 speed trans	51-62	\$249.95

*Bill's Truck Shop*

Phone (905) 725-3460 / (905) 725-2022 / (905) 404-2302

# Engine Transmission Parts

Group 41

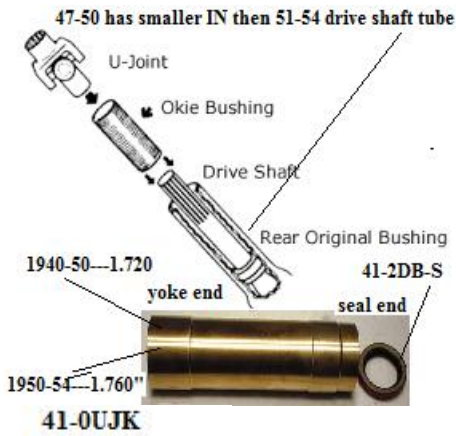

41-UJK

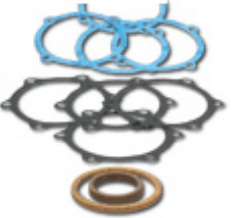

41-UJG



41-0UJR



41-2DSC



41-2201

## Transmission Gasket Set

		<u>Year</u>	<u>New</u>
41-2TG-3	3-speed	37-55	\$49.95
41-02TG-4	39-72 SM420 & 48-65 Muncie 4-speed	37-72	\$39.95

**Drive Shaft Bushing-** help to prevent u-joint damage and oil leaks.

41-2DB	40-50 cars - 1/2 chev & 40-50 GMC 1/2 ton	40-50	Inquire
--------	-------------------------------------------	-------	---------

41-2DB-1	1/2 ton Chev & GMC	51-55	Inquire
----------	--------------------	-------	---------

## Drive Shaft Bushing Seal

41-2DB-S	1/2 ton	40-50	\$22.95
----------	---------	-------	---------

41-2DB-1S		51-55	\$12.95
-----------	--	-------	---------

## U-Joint Repair Kit

41-0UJK	1/2 ton 3 and 4 speed	40-55	\$129.95
---------	-----------------------	-------	----------

## U-Joint Ball Seals and Gasket set

41-UJG	1/2 & 3/4 tons	29-53	\$41.95
--------	----------------	-------	---------

## U-Joint Retainer

41-0UJR	cup retainer only	40-54	\$5.95
---------	-------------------	-------	--------

## Cushion-driveshaft carrier





41-2DSC	3/4 & 1 ton	47-53	\$26.50
---------	-------------	-------	---------

*Bill's Truck Shop*

Phone (905) 725-3460 / (905) 725-2022 / (905) 404-2302

# Transmission

# Group 41

		<u>Year</u>	<u>New</u>
 <p>41-233-L</p>	<p><b>Bell Housing</b>            41-2800-47      47-49 has no shift lever pivot bolt on left side-used w / 3 speed floor shift trans            41-2800-50      w/ 3 speed column shift trans</p>	47-49	\$75.00
 <p>41-223-SK</p>	<p><b>Transmission Shift Lever Tension Spring kit-3 speed column shift</b>            41-223-SK    4 springs washers &amp; cotter pins</p>	49-55	\$14.95
 <p>41-0136</p>	<p><b>Shift Repair bushing w/ spring</b>            41-0136    corrects loose shift lever on 3 speed top loader</p>	37-47	\$36.95
 <p>41-0SM420-TS    SM420 4 speed trans</p>	<p><b>Shifter repair kit- 4 speed floor shift</b>            41-0137    4 pc kit</p> <p>The SM-420 4-speed transmission was produced by General Motors between the years of 1947 &amp; 1967. Starting in 1966 General Motors offered the NP-435GA for its light truck applications as an option. The NP-435-GA became the standard 4-speed sometime in the late 1960s. The cast iron case with large bulge on the passenger side makes the SM-420 easy to identify. Ribbing was added to the bulge on later cases, The ribbed SM-420 case should not be confused with the later SM-465 transmission. How can you tell which 4-speed your 1966 has, if reverse is to the driver &amp; down, it's the SM-420, if to the passenger &amp; down</p>	47-87	\$34.95
 <p>41-03305      41-0137</p>	<p><b>SM420 4 speed transmission parts</b>            Tailstock/rear yoke seal            41-0SM420-TS</p>	47-67	\$38.95

*Bill's Truck Shop*

Phone (905) 725-3460 / (905) 725-2022 / (905) 404-2302

New

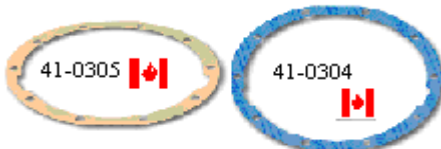

### Axle Seals-rear

41-0695	1/2 ton	each	38-63	\$25.95
41-081B	3/4 ton w/ out Dana rear axle-dana rear axle cover has straight sides-other axle has round cover		47-72	\$24.80
41-0870				

### Rear Axle Plug w/ gasket

41-0225			47-62	\$29.95
41-0225-G	plug gasket (leather)		47-62	\$4.95

### Rear Axle Cover Gasket

41-0304	1/2 - 3/4 10 bolt rear end 37-63 Chev 39-66 GMC 1/2 ton 1/16 (.063) thick		37-66	\$7.95
41-0088	3/4 - 1 - 1 1/2 H072-52 Eaton w/ 10 bolt cover		37-72	\$22.95

### Rear Differential Carrier Gasket

41-0305	1/2 - 10 bolt rear end 37-63 & 37-45 3/4 ton 39-70 1/2 GMC 1/32 (.031) thick		37-63	\$8.95
---------	------------------------------------------------------------------------------	--	-------	--------

### Pinion Seal

41-0970	3/4 - 1/ ton- 1 1/2 ton- w/ open drive shaft		46-65	\$49.95
---------	----------------------------------------------	--	-------	---------

### Bearings

#### Outer Axle Bearing

41-0502-EL	1/2 ton outer	each	38-62	\$99.95
------------	---------------	------	-------	---------

#### Inner Axle Carrier Bearing

41-0011-S	inner side bearings w/ race	each	40-55	\$84.95
-----------	-----------------------------	------	-------	---------

#### Pinion Bearing

41-0011-R	rear pinion bearing-rear		36-54	\$139.95
41-0011-F	front pinion bearing-front		40-54	Inquire

*Bill's Truck Shop*

Phone (905) 725-3460 / (905) 725-2022 / (905) 404-2302

# REAR END

# Group 41

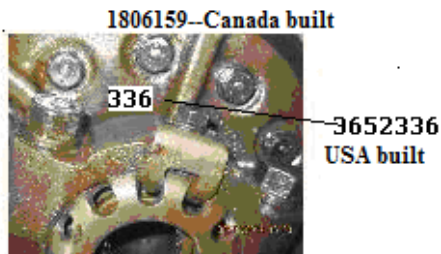

41-0260-CP

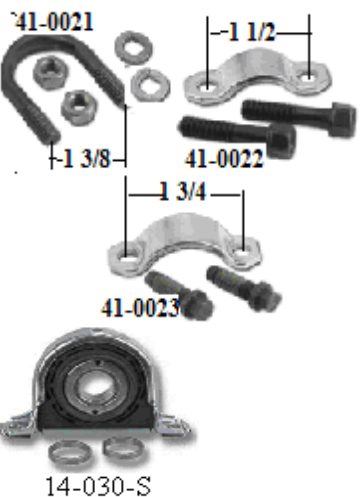

**Ring/Pinion set 3: 55 – 1 includes complete instruction**

41-0260-CP	40-53	\$699.95
------------	-------	----------

**Rear Axle Vent @ some trans**

16-0270	plastic w/ cover	64-72	\$7.95
16-0271	metal screw in	47-63	\$24.95
16-0270-K	rear axle vent w/ hose	60-87	\$11.95

**U-joint Retainer**

41-0021	1 3/8 center to center	each	\$12.95
41-0022	1 1/2 center to center	each	\$12.95
41-0023	1 3/4 center to center-metric	each	\$11.95

**Driveshaft Hanger Bearing Assembly**

14-030-S	1.3780" ID	54-94	\$99.95
----------	------------	-------	---------

*Bill's Truck Shop*

Phone (905) 725-3460 / (905) 725-2022 / (905) 404-2302

# FUEL PUMP

## Group 41



**Fuel Pump-requires using your OE fittings in pump- includes gasket---may require fuel line adjustment**

41-0149	w/ glass bowl filter	37-62 Chev/39-59 GMC	37-62	\$179.95
41-0429	w/o glass bowl	37-57 Chev/ when using this pump there should be a filter assembly @ carb #41-0668- pipe in and outlet hole in line OE style	37-57	\$124.95
41-0912	vac/fuel pump combination	39-59 GMC & 37-62 Chev	37-62	\$159.95
41-2241	GMC 6 cyl		47-53	\$55.00

**Fuel Pump Fitting-in and out let pipe**

41-0148	---fitting 1/8 NPT male x 5/16 tube OD			\$5.95
---------	----------------------------------------	--	--	--------

**Fuel Pump Rebuild kit**

41-0149-RK	glass bowl AC fuel pump		37-62	\$139.95
------------	-------------------------	--	-------	----------

**Fuel Hose**

41-0516	5/16 neoprene hose	----per foot		\$3.49
41-038	3/8 neoprene hose	----per foot		\$3.49

**Gas Filter Assembly-OE GM option**

41-0668	glass bowl w/ filter -mount at carb-new install requires 41-0668-H		40-62	\$39.95
---------	--------------------------------------------------------------------	--	-------	---------

**Gas Filter Fitting hdw kit- installing at carb**

41-0668-H	1 x 1/1/2 pipe—1 x straight -- 1x 90 deg line adaptor for straight or side pipe entry		40-62	\$19.95
-----------	---------------------------------------------------------------------------------------	--	-------	---------

**Gas Filter**

41-0668-F	filter for glass assembly w/ gsk		40-62	\$10.95
-----------	----------------------------------	--	-------	---------

*Bill's Truck Shop*

Phone (905) 725-3460 / (905) 725-2022 / (905) 404-2302

# OIL



**In-line fuel filter-steel-steel**  
**41-0032 w/ hose & clamp**

**Year New**

\$11.95



**Oil Filter Assembly**

41-0201-A original used assembly

37-62

**Cartridge Oil Filter** The Fram cannisters use a 7/8" wrench on the top bolt and have a crimped bottom w/ black top & orange canister-fram # C4 or C4P2 The A/C cannister uses a 5/8" wrench on the top bolt and has a smooth bottom.

41-0201-1 4 1/8 W x 5 9/16 H **FRAM** 37-62 \$24.95

41-0201-2 4 1/2 W x 5 H **AC** 37-62 \$29.65

41-0201-GMC 3 1/2 x 5 9/16 H **GMC ONLY** located on right ft of 6 cyl engine 39-62 \$22.95

41-0201-GMC-HD 4 W x 8 H **HD commercial** 39-62 \$29.95



**Oil Line Block kit - 3 pc set**

41-0249-A 2 outlet plug for oil gauge and filter line-screws in block

47-62

\$19.95

41-0249-1 1/8 pilot nut-line compression fitting \$2.95

41-0249-2 1/8 tube OD x 1/8 male pipe adapter \$5.95

41-0249-3 1/8 NPT "T" 3 outlet female \$7.95

41-0249-4 1/8 x 1" connector tube \$2.35



41-0201-A



**Oil Filter Decals**

41-020F-1 W/ Fram type -- 6 cyl engine

47-59

\$14.95

41-2AC W/ AC type-- 6 cyl engine

45-55

\$9.95



**Oil Filter Lines**

41-0249L 216-235 6cyl w/ nec fittings pair

37-62

\$69.95

*Bill's Truck Shop*

Phone (905) 725-3460 / (905) 725-2022 (905) 404-2302

# Engine Parts

# Group 41



### Generator Radio Warning Tag

41-OGT

Year

New

47-62

\$5.95

### Generator & Starter Tag----not numbered

41-000T w 12 volt gen or starter w/ rivets

55-62

\$8.95

41-000T-R pr of install rivets pair

\$3.50

### Air Breather Wing Nut-----check stud size

41-0741 1/4 x 20

40-66

\$0.75

41-0741-10 10 x 32

40-66

\$2.95

### Air Cleaner Element

41-0238 6" oil wetted copper mesh filter

41-55

\$69.95

*Bill's Truck Shop*

Phone (905) 725-3460 / (905) 725-2022 / (905) 404-2302

# DECALS

Group 41

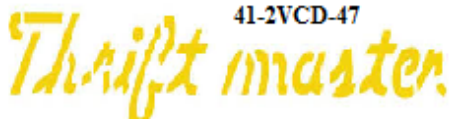

41-2VCD-47



41-2VCD-54



41-020C



41-020A



41-020B

### Engine Valve Cover Decals

		<u>Year</u>	<u>New</u>	<u>Used</u>
41-2VCD-47	THRIFTMASTER	47-53	\$6.00	
41-2VCD-54	THRIFTMASTER 235	54-55	\$5.00	
41-2VCD-54J	JOBMASTER 261	54-55	\$5.95	

### Air Cleaner Decals

		<u>Year</u>	<u>New</u>	<u>Used</u>
41-020A	oil bath type / angle style top –AC heavy duty	47-53 & 55-59	\$5.95	
41-020B	oil whetted element /flat style top –AC light duty	47-59 & 40-46	\$5.95	
41-020C	oil bath type-AC heavy duty	54-55	\$4.25	

*Bill's Truck Shop*

Phone (905) 725-3460 / (905) 725-2022 / (905) 404-2302

# Engine Parts-Radiator

Due to the fluctuation of the Canadian and American dollars call for current prices

Group 41



18-0401



18-0425

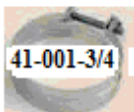

22-0205-1



22-0205

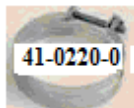

## Rad Hoses (formed hose)

			Year	New
41-2HU	1 3/16 "outlet	upper -6cyl	47-55	\$34.95
41-02HU-B	1 1/2 " outlet	upper 60-62 235/261	47-62	\$44.95
41-2HL	1 1/2 " outlet	lower-6cyl	47-55	\$48.95
41-2HL-B	w/ later 235/261 engine---	w/ larger 1/3/4 outlet on pump-cut to fit 1 1/2 @ rad	47-55	\$44.95

## Thermostat Housing- when adding newer 235 engine reuse or purchase the earlier outlet for correct 1 1/2 house size—see page 154-155 for gaskets

18-0245	-outlet-thermostat	216- 235 6 cyl 1 1/4 outlet	40-54	\$69.95
18-0245-B	-housing-thermostat/base	216/235 6 cyl	40-62	\$69.95

## Heater Hose Retainer w/ screw

22-0205	original used-	on pass inner fender	40-59	\$19.95
22-0205-1	heater or acc	AC line retainer	40-87	\$16.95

## Heater Hose —approx 3.5 to 4 ft required to secure on inner fender-MOST heater hoses are 5/8 -CONFIRM

18-0401	5/8 black-per foot			\$3.95
18-0402	3/4 black-per foot			\$4.25

## Thermostat

18-0160	160 deg			\$14.95
18-0180	180 deg			\$14.95
18-0195	195 deg			\$14.95

## Radiator Hose Clamps OE style screw clamps

41-001-1/2	OE style upper	1 1/2	each	\$5.50
41-001-3/4	OE style lower	1 3/4	each	\$6.95
41-002-0	OE style lower	2"	each	\$7.95
41-0220	1 1/2 - 2" screw type			\$4.95
41-0228	1 3/4"-2" wrap- screw type	each		\$2.50
41-004-3	2 1/16 – 2 1/4 OE style			\$7.95

## Heater Hose Clamps

41-0220	up to 1" wrap- screw type	each		\$1.95
41-0220-0	up to 1 " flat OE style	each	36-59	\$3.25

## Radiator Cap

41-0RC	w/ non pressure system		37-52	\$11.95
41-2RC-4A	4 lb w/ pressure system-replacement		47-55	\$14.95
41-0RC-16	16 lb rad cap for non stock engine application		47-87	\$13.95

Bill's Truck Shop

Phone (905) 725-3460 / (905) 725-2022 / (905) 404-2302

# Engine Parts-Radiator

Due to the fluctuation of the Canadian and American dollars call for current prices

Group 41



41-0252

41-2RAD-GA-B



41-2RAD-CA-S



**Radiator Dimensions:**

Total: 22" tall x 22.13" wide w bkts  
 Core: 16.5" tall x 19.25" wide 2" thick  
 Inlet: 1.5" drivers side  
 Outlet: 1.5" passenger side  
 Tanks 2.5" thick  
 Tubes 0.63" thick

18-00HA-2,

41-0254



GMC truck rad fill/cap are in front of the rad-(engine side ) as the upper rad support/hood latch panel brace does not allow for top fill---Chev rad fill/cap are on top and the upper rad support/hood latch panel brace is on the front side of support---to fit OE style frames NOT S10

**Radiators-brand new radiators in two different models- standard for 6&8 cyl ( 3 row tubes) or desert cooler for V-8 HD application ( 4 row tubes)- 1/2 " tubes @ 9/16 on center Chev only all have 1 1/4 inlet and 1/1/2 outlet pipe copper / brass construction -Chev rad are top fill & GMC front-when installing a SB Chev you can use 55-59 cyl rad hoses-call for more info 41-3U8 & 41-3L8 cut to fit**

<b>41-2070</b>	20 3/4 x 19 3/4 x2 w/ 3 row- hose - copper/brass connection for 6 cyl application w/ trans cooler-requires fitting # 41-0252 when installing auto transmission	47-55	\$899.95
<b>41-2070-4R</b>	20 3/4 x 19 3/4 x2 w/ 4 row- V8 copper/brass application w/ trans cooler	47-55	\$899.95

**NEW ALUMIMUM - on OE 6 cyl confirm thermostat housing inlet side 1 1/2 or 1 1/4**

Core size is 19 1/4" x 22 3/4". Top Inlet is 1 1/4". Lower Outlet is 1 1/2 for 6 cyl & 1 3/4 for 8 cyl application. These are welded construction there is no epoxy used in these radiators.-----trans fittings have flared seats for lines

<b>41-2RAD-CA-BLS w/ LS engine upgrade</b>	3 row w/ up (1.1/4) & lower(1 1/2) rad hose outlets on R side- includes steam port and auto cooler	47-55	\$449.95
--------------------------------------------	----------------------------------------------------------------------------------------------------	-------	----------

<b>41-2RAD-CA-B</b>	3/row w/ auto cooler,14 lb rad cap Chev only w/V8 1 3/4 lower pass outlet OD & 1.5 up center inlet	47-55	\$445.95
---------------------	----------------------------------------------------------------------------------------------------	-------	----------

<b>41-2RAD-CA-BB BLACK</b>	3/row w/ auto cooler,14 lb rad cap Chev only w/V8 1 3/4 lower pass outlet OD & 1.5 up center inlet	47-55	\$445.95
----------------------------	----------------------------------------------------------------------------------------------------	-------	----------

<b>41-2RAD-CA-BS</b>	47-54 Rad/Chev 2/ row aluminum w/cooler V8	47-55	
----------------------	--------------------------------------------	-------	--

<b>41-0252</b>	fittings- 1/2 oil cooler male thread 1/4 NPT oil line-9/16 drive pair		\$19.95
----------------	-----------------------------------------------------------------------	--	---------

<b>41-2RAD-CA-6</b>	2/ row w/ auto cooler,14 lb rad cap Chev only w/ OE 6 cyl 1 1/2 up--1 1/2 lower outlet	47-55	\$395.95
---------------------	----------------------------------------------------------------------------------------	-------	----------

**GMC RAD**

<b>41-2RAD-GA-B</b>	OE GMC has rad fill on side facing cab - 3/row w/ auto cooler,14 lb rad cap GMC only--	47-55	\$395.00
---------------------	----------------------------------------------------------------------------------------	-------	----------

<b>41-2RAD-CA-S</b>	NEW ITEM Replacement rad when installing a 1947-54 CHEV truck on an S10 frame-- 3- row aluminum rad w/ trans cooler--- may require minor modification FAN shroud# 41-2FS-1 will not fit this application	47-55	\$449.95
---------------------	----------------------------------------------------------------------------------------------------------------------------------------------------------------------------------------------------------	-------	----------

<b>41-2RAD-CA-SLS</b>	same as above w/ LS engine	47-55	\$449.95
-----------------------	----------------------------	-------	----------

**Radiator Petcock**

41-0254	brass	40-87	\$8.95
---------	-------	-------	--------

**Hose Adaptors**

18-00HA-1	Hose adaptors -adjusts up from 1 3/4 to 2 "		\$11.95
18-00HA-2	Hose adaptors -adjusts up from 1 1/2 to 1 3/4 "		\$11.95

*Bill's Truck Shop*

Phone (905) 725-3460 / (905) 725-2022 / (905) 404-2302

# Radiator

Due to the fluctuation of the Canadian and American dollars call for current prices

Group 41

Year      New

44-0016- R



44-0016-SD

44-0016-S



41-2RAD-CA-B

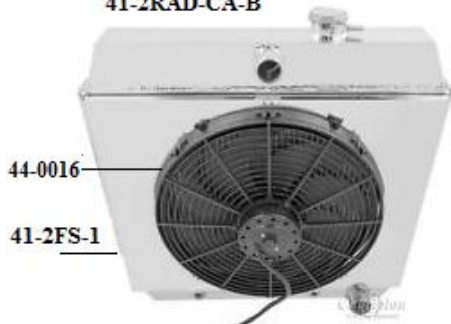

44-0016

41-2FS-1

44-0910

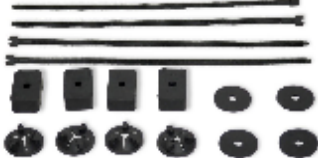

41-0FS-3

20-3/4" H x 19-1/4" W



41-2FS-1



### Relay-electric fan control

**44-0016-R** This adjustable electric fan switch with thermostat allows you to run your electric fan-installs temp probe in rad fins

universal      \$42.95

### 44-0016-S

This Electric Fan Relay with Thermostat kit allows you to run your electric cooling fan in a much more efficient manner. It powers up your electric fan when your motor reaches -175-185 degrees F and powers down when your motor reaches 170 degrees F w/ temp sender 50-60 amp relay

universal      \$69.95

### 44-0016-SD

Dual fan relay Kit, 80 Amps, 12V, temp sender, two 40 Amp relays, On at 195 degrees, Off 180 degrees, Harness, Kit

universal      \$114.95

### Electric Fan

**44-0016** Produces a 1600 CFM Rating at 18.4 or 14 amp draw.  
 • This fan is 3 1/4" deep through the center of the motor; it gradually thins to 1 1/2" at the outer edge.  
 • Curved blades are quiet and push the same amount of air as a straight blade.  
 • Factory built as a puller, mounted inside and pulls the air through the radiator.  
 • 12V REVERSIBLE 'S' BLADE - Blades & polarity of the wiring can be reversed & it becomes a pusher

universal      \$99.95

**44-0014** 13.82 " wide//2 58 " deep 1200 CFM 12 V 90 W reversible

universal      \$99.95

**44-0012** 12 " wide 870 CFM 12 V reversible

universal      \$89.95

### Install Kit-electric fan

44-0910      \$16.95

### Fan Shroud

41-2FS plastic-cut for fan opening      47-55      \$79.95

### Fan Shroud

41-2FS-1 aluminum shroud -accepts 1 single 16" electric fan secures to rad      47-55      \$129.95

### Universal-----upper fan guard

41-0FS-3 polished stainless steel 3" deep x 20 dia      universal      \$42.00

41-0FS-5 polished stainless steel 5" deep x 20 dia      universal      \$42.00

*Bill's Truck Shop*

Phone (905) 725-3460 / (905) 725-2022 / (905) 404-2302

# Water Pump -ETC

Due to the fluctuation of the Canadian and American dollars call for current prices

Group 41

Water Pump	Year	New
5/8 pulley has 2 1/4 fan bolt spacing-- 41-2165 Chev- NEW 216-235 w/ 5/8 pulley on block and head	41-52	\$199.95
41-2166 Chev -NEW 216-235 w/ 3/8 pulley -on block only	53-55	\$224.95
<b>GMC water pumps outlets are opposite of Chev Water Pump-conversion-shortened 55-59 water pump w/ 3/8 belt pulley when installing 1955-62 235 CI engine in 1954 earlier truck-no need to move rad forward-see 2 styles</b>		
41-235-K w/ 4 1/4 pulley for 3/8 belt -use early 216 fan		\$319.95
41-235-K1 w /6" pulley ,spacer for 3/8 belt-use 1955 up 235 fan		\$319.95
41-2HL-B HOSE w/ later 235 w/ larger 1/3/4 outlet on pump	47-55	\$44.95
<b>Heater hose fitting @water pump &amp; thermostat housing</b>		
41-0881 5/8 hose fitting	41-54	\$17.95

1 1/2 bolt spacing

15/16 shaft dia



41-2165

5/8 pulley



1 1/2 bolt spacing

15/16 shaft

3/8 pulley



41-2166

4 1/4 pulley 3/8 belt



41-235-K

41-235-K1



41-0881



41-0167

41-2HL-B



Bill's Truck Shop

Phone (905) 725-3460 / (905) 725-2022 / (905) 404-2302

# Water Pump-ETC

Due to the fluctuation of the Canadian and American dollars call for current prices

Group 41



		Year	Price
<b>Thermostat Housing</b> -straight forward-angle V8			
18-0453	used when installing V8 w/ OE type rad		\$22.95
<b>Hose-rad overflow drain 30" 3/8 thin walled-ribbed hose</b>			
10-00FH			\$9.95
<b>Radiator Overflow Bottle kit</b>			
41-2255	OE GM accessory w/ instructions	47-55	\$139.95
<b>Heater Hose Clamps</b>			
41-0220	up to 1" wrap- screw type	each	\$1.95
41-0220-0	up to 1" flat OE style	each	\$3.25
41-0004	7/32-5/8	each	\$1.25
41-0007	5/16 - 11/16	each	\$1.25
41-0009	1/2 - 29/32		\$1.25
<b>Fan Belt</b>			
41-2FB-47	w/ 5/8 wide pulleys	47-52	\$32.95
41-2FB-47-A	w/ 5/8 pulley & / alt- .53 wide x 41" long		
	-runs lower in 5/8 wide crank & water pump & still fits new alt pulley	47-52	\$39.95
41-02FB-1	w/ 3/8 wide pulleys	37-54	\$26.95
41-03FB-2	GMC w/ 3/8 groove pulley 6 cyl	39-59	\$27.95
41-03FB-3	GMC w/ 5/8 groove pulley 6 cyl	39-59	\$29.95
41-03FB-4	GMC w/ 3/4 groove pulley 6 cyl	39-59	\$22.95
<b>Fan Blade</b>			
41-FBL	216 or early 235 ci engine only- 1" center shaft hole w/ 1 1/4" pump bolt pattern	37-53	\$49.95
<b>Water Pump-engine fittings</b>			
41-0058	5/8 hose fitting 1 1/2" long		\$11.95
41-0034	3/4 hose fitting 1 1/2" long		\$11.95
41-0034-L	3/4 hose fitting 2 1/2" long		\$11.95

*Bill's Truck Shop*

Phone (905) 725-3460 / (905) 725-2022 / (905) 404-2302

# Ignition-Engine Parts

Due to the fluctuation of the Canadian and American dollars call for current prices

Group 41



	Year	New
<b>Distributor</b>		
41-0D-235 235 CI engine/ plus \$30-00 core charge if core is not useable includes new cap, rotor, points, condensor	53-62	Inquire
<b>Distributor Vacuum Advance</b>		
41-0DVA 6cyl	37-62	\$59.95
<b>Clips-vac &amp; fuel</b>		
41-0195 3 pcs set secures dist vac line to fuel line	37-62	\$16.95
<b>Dist Cap</b>		
41-2DC-47 6 cyl dist cap 2 " high 33-53 Chev & 39-59 GMC	33-59	\$39.95
41-02DC-53 6 cyl dist cap	53-62	\$45.95
<b>Dist Rotor</b>		
41-2DR-47 6 cyl dist rotor 33-53 Chev & 39-59 GMC	33-59	\$22.95
41-02DR-53 6 cyl dist rotor	53-62	\$28.95
<b>Ignitions Points w/Condenser</b>		
41-02PC	41-62	\$62.95
<b>Ignition Resistor</b>		
18-0203 reduces ignition from 12v to 9v	47-59	\$29.95
<b>Spark Plug Wire Set w/ sealed plug caps 7mm</b>		
41-02PW-6 6 cyl	47-62	\$59.95
41-02PW-6C 6 cyl correct carbon core (helps reduce radio static ) "open metal ends" 90% @ spark plug' used on 216 (also can be used on the 235) w/ two rubber rings to secure wires in sets of three-correct for 35-53 but also will work on 54-55	35-53	\$49.95
<b>Delco Electronic Ignition-6V</b> —delivers twice the voltage to the spark plugs-improves start-up-fuel mileage-performance—uses existing coil & dist		
41-0168-6 6cyl 6 volt neg ground	40-55	\$224.95
<b>Spark Plugs</b>		
41-02SP-47 10 mm Chev only	41-48	\$6.00
41-02SP-49 14 mm 6cyl 37-40 & 49-62 Chev-----39-59 GMC		\$7.95
<b>Ignition Coil</b>		
41-2IC-6 6 volt		\$44.95
41-02IC-12 12 volt		\$42.95
<b>Spark Plug Wire Tubing</b>		
41-0710 chrome tubing for 216 / 235 w/ center bolt type valve cover pair	40-52	\$33.75

*Bill's Truck Shop*

Phone (905) 725-3460 / (905) 725-2022 / (905) 404-2302

# Ignition-Engine Parts

Due to the fluctuation of the Canadian and American dollars call for current prices

Group 41

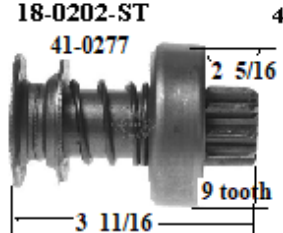

**CORE CHARGE apply to starter & gen \$25.00**

**Starter-----REBUILT**

		Year	New
41-027-6	6 cyl , 6 volt w/ ft start	38-55	\$349.95
41-027-12	6 cyl converted to 12V ft start	38-55	\$495.95
41-027-12/6	6 cyl 12V starter converted to 6V for 55-62 235 engine—installed in 38-55 6 volt trucks	55-62	\$349.95

**Starter Switch -foot Start with side terminal**

18-0202-ST	with side terminal for 12V ignition	38-59	\$29.95
18-0202	w/ out side terminal w /6 volt	38-59	\$32.95

**Starter Drive**

41-0277	9 tooth 2 5/16 width drive	38-55	\$79.95
---------	----------------------------	-------	---------

**Starter Brush set**

41-0059		41-62	\$15.95
---------	--	-------	---------

**Generator-----confirm 3/8 OR 5/8 pulley and 5 1/2 " or 7 " case**

41-0G-6V	6 volt	REBUILT	47-63	\$349.95
41-0G-12V	12 volt	REBUILT	47-63	\$295.00

**Voltage Regulator-replacement ----neg ground**

18-210-6	6v w/ screw on terminals	40-55	\$269.95
18-0210-12-25	12 volt w/ 25 amp gen	47-62	\$69.95
18-0210-12-35	12 volt w/ 35 amp gen	47-62	\$69.95
18-0210-HK	OE style set of 3	47-62	\$1.95

**Alternator-SI 1 wire activates on RPM-NO voltage regulator required**

19-0055	12 volt- 55 amp- NEW-requires 1 wire hook up may require turning housing for positive pin		\$229.95
---------	-------------------------------------------------------------------------------------------	--	----------

19-0033	female integral alt plug w/ terminals		\$7.95
---------	---------------------------------------	--	--------

19-0044	6 volt (GM type 10S) 55 amp 3/8 belt pulley		\$199.00
---------	---------------------------------------------	--	----------

41-2FB-47-A	w/ 5/8 pulley & / alt- .53 wide x 41" long -runs lower in 5/8 wide crank & water pump & still fits new alt pulley	47-52	\$39.95
-------------	-------------------------------------------------------------------------------------------------------------------	-------	---------

19-0380	Replacement harness when adding SI alt	41-53	\$69.95
---------	----------------------------------------	-------	---------

**Alternator Brackets w/ 6 cyl engine**

41-2AB	37-55 Chev-GMC pickup & 51-54 pass car to convert from a gen to alternator-may require modification to adjust arm	37-55	\$99.95
--------	-------------------------------------------------------------------------------------------------------------------	-------	---------

**Bill's Truck Shop**

Phone (905) 725-3460 / (905) 725-2022 / Fax (905) 404-2302

# Engine Parts

Due to the fluctuation of the Canadian and American dollars call for current prices

Group 41

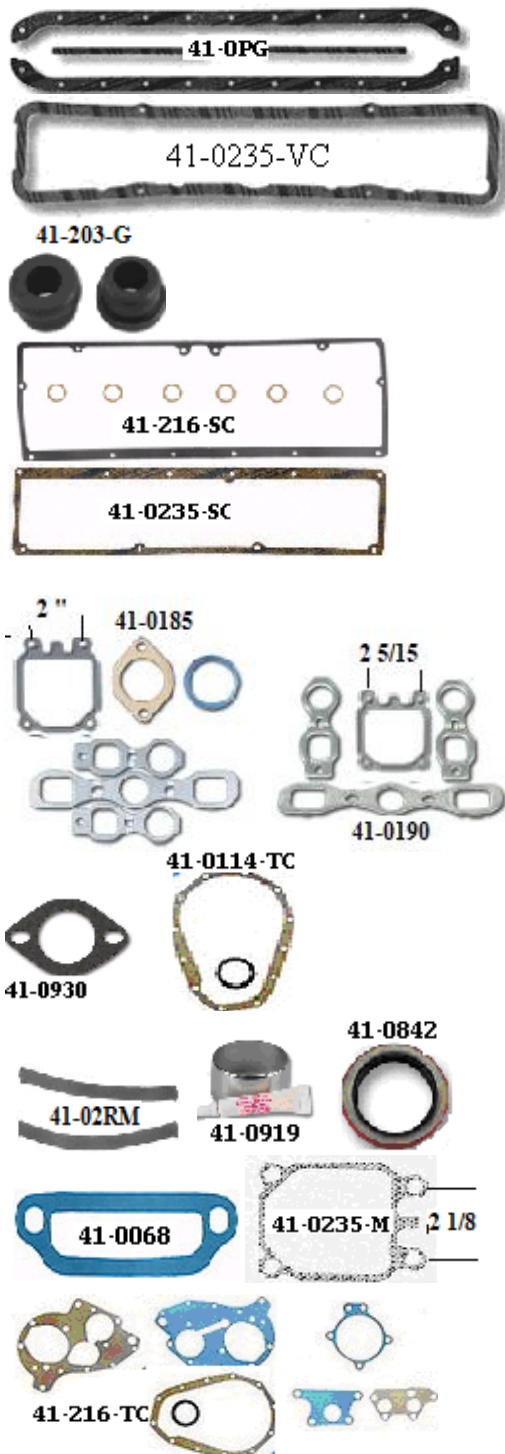

		<u>Year</u>	<u>New</u>
<b>Oil Pan Gasket set</b>			
41-0PG	37-53 -216/41-55 -235 engine	37-55	\$34.95
41-0PG-55	235 engine	55-62	\$59.95
41-0PG-GMC	228-236-248-270 6 Cyl GMC	39-59	\$44.95
<b>Rear Main Seal set</b>			
41-02RM	216-235-261 engine- NEW 2 pc rope	40-62	\$62.99
41-02RM-B	216-235-261 engine OLD 2 pc rope	40-62	\$19.95
41-02RM-GMC	228-236-248-270-302	39-62	\$62.99
<b>Valve Cover Gasket</b>			
41-0235-VC	fits both 216-235 w/ top or side mount bolts	37-62	\$35.95
41-0228-VC	228/236/248/270/302 GMC 6 cyl	39-62	\$44.95
<b>Valve Cover Grommets</b>			
41-203-G	w/ 2 center bolts 34-53		
Chev/39-59 GMC	pair	34-59	\$4.95
<b>Side Cover Gasket</b>			
41-216-SC	216 engine -push rod cover w/o-ring	37-52	\$43.95
41-0235-SC	216-235 engine- push rod cover	53-62	\$29.95
41-0228-SC	226-236-248-270 6 cyl GMC	39-59	\$29.95
<b>Timing Cover Gasket set 228/236/248/270-52-59-302</b>			
41-0114-TC		37-62	\$59.95
<b>Timing Cover Crank Seal</b>			
41-0842	1 pc	37-62	\$27.95
<b>Balancer Repair kit</b>			
41-0919	corrects groove-w/ sleeve 6 cyl-SB v8	47-87	\$24.95
<b>Intake to Exhaust Manifold Gasket only-1 pc</b>			
41-216-M	216 engine 2 7/16	37-53	\$7.95
41-0235-M	235 engine 2 1/8	53-62	\$7.95
<b>Intake &amp; Exhaust Manifold to Head Gsk set</b>			
41-0190	includes between intake & exhaust ,pipe to manifold etc 216 engine-check inner stud spacing	37-50	\$39.95
41-0185	includes between intake & exhaust ,pipe to manifold etc 235 engine check inner stud spacing	50-62	\$38.95
41-0008	6 cyl 248-270 (50-51)/ 302 (52-59) GMC	50-59	\$28.95
<b>Thermostat Gasket</b>			
41-0930	all 6 or 8 cyl		\$3.95
<b>Thermostat Housing to Block Gasket</b>			
41-0068	216--235	37-62	\$4.95

*Bill's Truck Shop*

Phone (905) 725-3460 / (905) 725-2022 / (905) 404-2302

# Engine Parts

Due to the fluctuation of the Canadian and American dollars call for current prices

Group 41

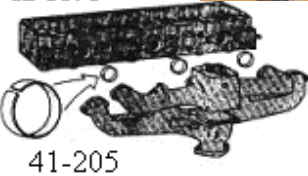
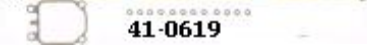
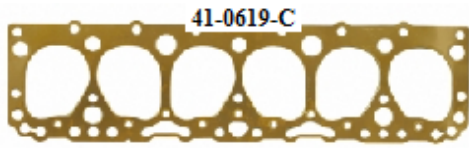

**Engine Valve Grind set**-includes head-intake-exhaust-valve cover-push rod cover-oil pan-valve stem seals-thermostat-water outlet etc

41-0619	235 6 cyl	53-62	Inquire
---------	-----------	-------	---------

**Engine Rebuild Kit**

41-2539	235 6 cyl	50-52	\$199.95
---------	-----------	-------	----------

**Water Pump to Block Gasket**

41-0069	216 & 235 6 cyl	47-54	\$9.95
---------	-----------------	-------	--------

41-0069-53	235 6 cyl	55-62	\$5.95
------------	-----------	-------	--------

**Water Pump to Cover Plate Gasket**

41-0070	216 & 235 6 cyl	47-55	\$4.50
---------	-----------------	-------	--------

41-0070-53	235 6 cyl	53-62	\$4.00
------------	-----------	-------	--------

**Fuel Pump Gasket**

41-0075	6 & 8 cyl	47-86	\$3.95
---------	-----------	-------	--------

**Intake Manifold Alignment Sleeves**

41-0205	34-53 207 & 216 Chev CI engine/41-49 235 Chev engine / 39-59 GMC engine ----	34-53	
	approx 1 3/8 OD set of 3	38-59	\$11.95

41-0205-1	235 & 261 CI Chev engine	50-62	\$16.95
	approx 1 1/2 OD set of 3		

**Valve Cover Grommets**

41-203-G	w/ 2 center bolts	pair	47-53	\$4.95
----------	-------------------	------	-------	--------

**Valve Cover Nuts- Acorn style-stainless steel**

41-203-N	34-53 Chev & 39-59 GMC	pair	34-59	\$6.95
----------	------------------------	------	-------	--------

41-203-NS	34-53 Chev & 39-59 GMC	steel/pair	34-59	\$9.95
-----------	------------------------	------------	-------	--------

**Cam Gear-fibre type**

41-0500	Cam Gear-216/228/235/248/270	42-62	\$84.95
---------	------------------------------	-------	---------

*Bill's Truck Shop*

Phone (905) 725-3460 / (905) 725-2022 / (905) 404-2302

# Exhaust Parts

Due to the fluctuation of the Canadian and American dollars call for current prices

Group 41

		<u>Year</u>	<u>New</u>
	<b>41-0400</b>		
	<b>41-0400-1</b>		
	<b>41-0206</b>		
	<b>41-0899</b>		
	<b>41-0507</b>		
	<b>41-0957</b>		
	<b>41-0135</b>		
	<b>41-0103</b>		
	<b>41-0235-SH</b>		
	<b>41-2235</b>		
	<b>44-0303</b>		
<b>Heat Riser Spring</b>			
41-0206	6 cyl	37-65	\$32.95
<b>Exhaust pipe to manifold stud</b>			
41-0507	one stud (3/8 x 2 1/2 long) w/ deep brass nut -- each		\$9.95
41-0957	brass nut- style pr		\$5.40
<b>Exhaust pipe to manifold stud-oversize</b>			
41-0507-OS	7/16 x 2 1/2-- to replace broken/drilled stud from manifold		\$5.95
<b>Exhaust Flange w/ 2" pipe</b>			
41-0899	3 1/8 center to center on stud		\$15.95
<b>Exhaust Donut-w floating flange</b>			
41-0400	ft pipe to manifold 2" ID		\$6.95
<b>Exhaust Gasket-some pipes w/ fixed flange bolt flat to manifold 2 15/16 approx stud spacing</b>			
41-0400-1	ft pipe to manifold flat gasket		\$3.00
<b>Exhaust Clamp</b>			
41-0115	1 1/2 "		\$2.25
41-0134	1 3/4 "		\$4.50
41-0020	2 "		\$4.95
41-0218	2 1/8"		\$3.30
41-0025	2 1/4 "		\$4.45
<b>Muffler-Frame Bracket</b>			
41-2235		47-55	\$29.95
<b>Muffler Strap w/ hook</b>			
41-0235-SH		40-59	\$13.95
<b>Muffler Strap</b>			
41-0235-S	satin coated steel 20 " long	40-59	\$8.95
<b>Tailpipe Hanger</b>			
41-0135		47-59	\$18.95
<b>Universal Exhaust Hanger</b>			
41-0103			\$21.95
<b>Exhaust Deflector</b>			
44-0303	stainless steel w/ Chev logo		\$34.95

*Bill's Truck Shop*

Phone (905) 725-3460 / (905) 725-20(905) 404-2302

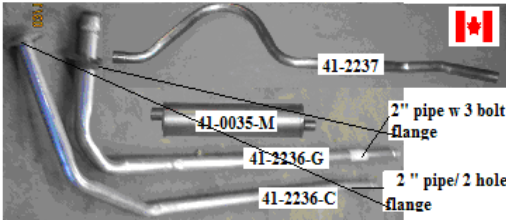

**Front Pipe—**for short bed –see ext for long bed-  
---galvanized pipe

41-2236-C	2"pipe 6 cyl Chev w/ 2 hole flange	47-55	\$224.95
41-02236-G	2" pipe 6 cyl GMC w/ 3 hole flange	47-55	\$169.95

**Tailpipe**

41-2237	1 3/4 pipe 6 cyl Chev & GMC w/ turn down end to exit below rear bumper on short step & behind bumper on long beds	47-55	\$159.95
41-2237-L	2 "extension pipe for 8 and 9 ft beds to exit tailpipe below rear cross sill cut to fit application	47-55	\$59.95

**Muffler**

41-0035-M	21"L x 5"W accepts 2" inlet pipe & 1 3/4 outlet pipe-----ID spec	40-59	\$99.95
-----------	------------------------------------------------------------------	-------	---------

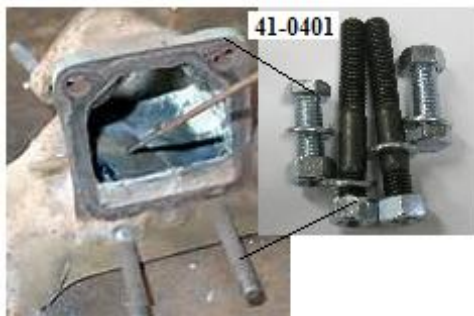

**Exhaust to Intake bolt kit**

41-0401	2 bolts ( 1 ¼ ) & 2 studs ( 3 ¼ ) w/ hdw		\$9.95
---------	------------------------------------------	--	--------

*Bill's Truck Shop*

Phone (905) 725-3460 / (905) 725-2022 / (905) 404-2302



**Proportioning Valves**

17-0PVKS-2 \$149.95  
 Brake Proportioning Valve -disc/drum w/ lines-when converting to disc front **Brass**

17-0PVKS-4 \$149.95  
 Brake Proportioning Valve -disc/disc w/ lines-when converting to disc front and rear **Brass**

17-0PVKS-A4  
 Brake proportioning valve-disc-disc & disc drum w/ lines & basket \$159.95

17-0PVK-H  
 Replacement harness w/ socket \$12.95

**Disc Brake kit**

47-59-5 **lug disc brake kit**—uses stock ½ spindles & hubs  
 Kit includes rotors, 5x 4 ¾ bolt pattern--- calipers, brackets, flex hoses and hardware Bearing upgrade(tapered roller w/ seals is recommended? may not work with stock wheels-1947-49 may require re-drilling lower spindle holes from 7/16 to ½

45-0WBK-5 ½ ton 47-59 \$724.95

47-59 **6 lug disc brake kit**—uses stock ½ spindles & hubs.Kit-includes rotors, callipers, brackets, flex hoses and hardware Bearing upgrade(tapered roller w/ seals) is recommended-may not work with stock wheels-47-49 may require re-drilling lower spindles holes from 7/16 to ½ “

45-0WBK-6 ½ ton 47-59 \$799.95

**Wheel Bearings kit-upgrades to tapered roller**

bearings w/ grease seals ½ ton only

38-04759-BK 47-59 \$224.95

38-04759-S replacement grease seal each 47-59 \$13.95

47-59 **Disc brake upgrade bkt kit ½ ton** 47-59 \$174.95

45-0DBK-5  
 5 x 4 ¾ bolt pattern-add callipers, 11”, rotors w/ bearing upgrade kit, brackets, flex hoses and hardware-bolts to stock spindles. Converts your straight axle to disc brakes-used factory holes on ½ ton spindle-kit includes calliper brackets, bearing adaptors & hdw-used 70-77 Camaro rotors & callipers--will also have to upgrade to dual master & prop valve

17-0BR13 Inner wheel bearing each \$16.95

17-0BR49 Outer wheel bearing each \$12.95

17-0BR2 Outer wheel bearing each \$4.95

17-0984 grease seal each \$6.95

**Phone (905) 725-3460 / (905) 725-2022 / (905) 404-2302**





**Intake Vacuum Port**

17-0VP-1 1 port hose fitting - 3/8 intake hole- for power brakes \$29.95  
 17-0VP-2 \$29.95

**Brake Booster & PCV Hose**

Hose-booster vac w/clamps-OE style 3/8 40 " long w/ curved end \$18.95

**Brake Booster Check Valve w/ Grommet**

17-0BV-B black \$12.95



**Universal brake booster**

45-0DD8 8" dual diaphragm zinc plated \$169.95

**Residual pressure valve-  
 Inlet & outlet-3/8-24 inverted flare**

45-0RPV-2 2 lb disc brakes \$15.95  
 45-0RPV-10 10 lb drum brakes \$15.95

*Phone (905) 725-3460 / (905) 725-2022 / (905) 404-2302*

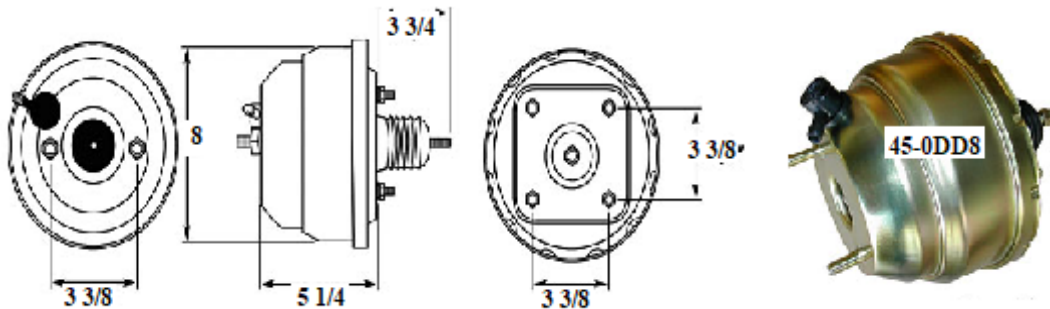

Ever had problems with a spongy pedal or slow, unresponsive brakes? If so, you may need a residual pressure valve installed in your brake line. A residual valve acts like a one-way or check valve to maintain brake system pressure to eliminate the problems of a spongy pedal. This 2 PSI residual valve is installed in line between the master cylinder and disc brake calipers to keep 2 PSI of residual pressure at the caliper after the brake pedal is released. This ensures that you will have a high, firm pedal next time you press the brake pedal. If your master cylinder is located below the floorboard, installing a 2 PSI residual valve is highly recommended. If your master cylinder is mounted on the fire wall, a residual valve is generally not needed because gravity will provide a natural residual pressure within the brake line.

Hold 10 lb of line pressure at all times- Keeps wheel cylinder cups expanded and ready to move  
 For use in brake line supplying drum brakes- Should be mounted as close to the master cylinder



42-2SM-4



		<u>Year</u>	<u>New</u>
<b>Shop Manual</b> Exact reprints of the original factory shop manuals, Includes data, specifications, capacities, wiring diagrams, etc – <i>supp year requires previous year</i> .			
42-2SM-8	Chevrolet	47-53	\$39.95
42-2SM-4	Chevrolet	54-54	\$39.95
42-2SM-5	Chevrolet	1955 Supplement	\$19.95
42-2SM-G	GMC	47-54	\$39.95
<b>Owners Manual</b> With GM plastic folder.			
<b>Chevrolet</b>			
42-247-48C		1947-48	\$22.95
42-249C		1949	\$22.95
42-250C		1950	\$29.95
42-251C		1951	\$29.95
42-252C		1952	\$29.95
42-253C		1953	\$29.95
42-254C		1954	\$29.95
42-255C	1st series	1955	\$29.95
<b>GMC w/o bag</b>			
42-247-48G		1947-48	\$22.95
42-249G		1949	\$17.95
42-250G		1950	\$17.95
42-251G		1951	\$17.95
42-252G		1952	\$17.95
42-253G		1953	\$17.95
42-254G		1954	\$17.95
42-255G	1st series	1955	\$17.95
<b>Accessory List &amp; Price Schedule</b> Helps to identify NOS accessory parts for your year & model.			
42-247A		1947	\$5.25
42-248A		1948	\$5.25
42-249A		1949	\$5.25
42-250A		1950	\$5.25
42-251A		1951	\$5.25
42-252A		1952	\$5.25
42-253A		1953	\$5.25
42-254A		1954	\$5.25
<b>Radio-Service &amp;Shop manual</b>			
42-2RM		47-53	\$9.95

**Bill's Truck Shop**

Phone (905) 725-3460 / (905) 725-2022 / (905) 404-2302

# Literature

# Group 42



**Accessory Installation Manual Detailed** illustrations of all accessories and explains how they are installed. *for passenger cars and trucks*

	<u>Year</u>	<u>New</u>
42-249M	1949	\$10.00
42-251M	1951	\$11.00



42-2FAM

**Factory Assembly Manual** Exploded views of the assembly of the trucks. Pertains to all years and GMC also.

42-2FAM	47-54	\$54.95
---------	-------	---------



42-2WD

**Wiring Diagrams**

42-2WD-47	47-53	\$9.95
42-2WD-54 and 1 st 55	54-55	\$9.95

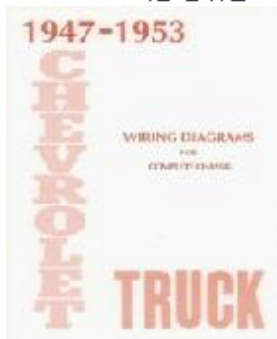

## Bill's Truck Shop

Phone (905) 725-3460 / (905) 725-2022 / (905) 404-2302

# Accessories

# Group 44



44-0303



44-030

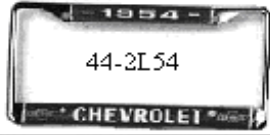

44-2L54



44-028



44-009



44-006



44-007



44-0SE



44-0TV



44-2150

13-210



### Exhaust Deflector –stainless steel

44-0303 w/ Chevy logo each \$34.95

### Licence Plate Frame–chrome w/ blue details–year at top w/ CHEVROLET at bottom. each

	Year	New
44-2L47	47-47	\$14.95
44-2L48	48-48	\$14.95
44-2L49	49-49	\$14.95
44-2L50	50-50	\$14.95
44-2L51	51-51	\$14.95
44-2L52	52-52	\$14.95
44-2L53	53-53	\$14.95
44-2L54	54-54	\$14.95
44-2L55	55-55	\$14.95

### Licence Plate Fasteners

44-028	set of 4 chrome bullets	\$4.95
44-029	stainless steel carriage bolts w/ hdw set of 4	\$2.95
44-030	4 nylon nuts w/ w screws	\$6.95

### Traffic Light Viewer Repro of factory accessory.

44-0TV 47-59 \$89.95

### Door Vent Shades Original GM option (pair)

44-2150 Stainless steel pair 51-55 \$69.95

*Bill's Truck Shop*

Phone (905) 725-3460 / (905) 725-2022 / (905) 404-2302

# EXTERIOR SUN VISORS

Group 44



44-0SV-1 Chevy-Pontiac-Olds 2 & 4 dr sedan, coupe, wagon w/ 2pc windshield universal fit- steel/black metal w/stainless trim

Year      New

49-53      \$724.95



**Outside Sun Visor**-a beautiful reproduction of the Fulton 800 style-w/ all hardware and instruction-for split windshields

44-2SV **steel/ black** adjustable-will fit Chev-Ford-Dodge-Plymouth cars & trucks w/ split windshield

37-53      \$699.95

44-2SV-A **aluminum/green** adjustable  
47-53 Chev-GMC truck / 41-48 pass car & wagon

47-53      \$665.00



44-2SU-S stainless steel long & short center supports for Fulton visors pair

37-53      \$69.95

44-2SB-L outer left side (dog bone) support

37-53      \$114.95

44-2SB-R outer right side (dog bone) support

37-53      \$114.95

44-2S-VR center adjust rods w/ hdw pair

37-53      \$99.95

]

*Bill's Truck Shop*

Phone (905) 725-3460 / (905) 725-2022 / (905) 404-2302

# EXTERIOR SUN VISORS

Group 44

Year      New



44-2SV-54

**Outside Sun Visor**-a beautiful reproduction of the Original GM accessory-w/ all hardware and instruction

54-55

\$724.95

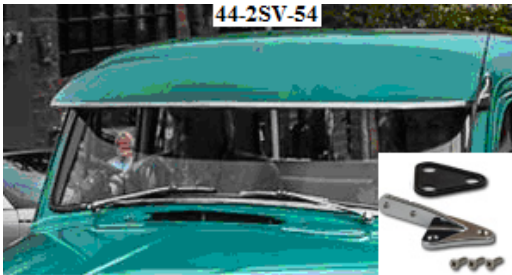

44-2SV-54



44-2SB-54

44-2SB-54      outside visor ( 1pc) supports-pr

54-55

\$149.95

*Bill's Truck Shop*

Phone (905) 725-3460 / (905) 725-2022 / (905) 404-2302

# PERFORMANCE ACCESSORIES



## Rad Overflow Tank

		<u>Year</u>	<u>New</u>
44-0255-15	15 " polished stainless steel	universal	\$89.95
44-0255-13	13 " polished stainless steel	Universal	\$79.95

44-0PVC	Gas pedal w/chrome vertical bars, rubber insert, spring loaded, adjustable arm & L or R mount	universal	\$109.95
---------	-----------------------------------------------------------------------------------------------	-----------	----------

44-0TBS	Accel bkt @ carb w/ return springs stainless steel	universal	\$29.95
---------	----------------------------------------------------	-----------	---------

44-0TBS-1	Accel bkt @ engine w/ return springs-stainless steel	universal	\$19.95
-----------	------------------------------------------------------	-----------	---------

44-0TBS-2	Throttle cable bkt w/ 350/400 kickdown adapt stainless steel	universal	\$34.95
-----------	--------------------------------------------------------------	-----------	---------

7-0007	Accel spring set	universal	\$14.95
--------	------------------	-----------	---------

## Adjustable Throttle Cables

44-0TC-24	24 ' long/black coating	universal	\$34.95
-----------	-------------------------	-----------	---------

44-0TC-24-SS	24" long/stainless steel	universal	\$54.95
--------------	--------------------------	-----------	---------

Pedal Pad-universal			
45-0213			\$49.95

Pedal Pad Mount-universal			
45-0213-M			\$49.95

*Bill's Truck Shop*

Phone (905) 725-3460 / (905) 725-2022 / (905) 404-2302

# STEERING UPGRADES



40-0175BCS

40-0150BCS-A

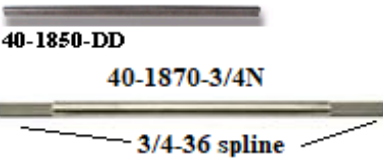

40-1850-DD

40-1870-3/4N

3/4-36 spline



40-0626-AD

41-0UJ18

41-0UJ3



40-00SF



40-0CSR

**Column Saver kit** allows reusing the original column w/ Mustang  
If front ends or any other replacement steering box-installs housing w/ bearing in original column-complete w/ instructions

40-0175BCS 47-59 GM trucks & cars w/ 1 3/4 column

40-0150BCS GM w/ 1 1/2 column

40-0150BCS-A GM trucks & cars w/ 1 1/2 column w/ 3/4 x 3/4 DD U-joint & stub shaft

**Column Steering Shaft** extension 3/4 DD shaft when extending from column to steering rack or box

40-1850-DD-BO -black oxide 18"

40-1850-DDN nickel plated 18"

40-0024 STEEL 24"

40-3650-DD unplated steel 36"

40-3650-DD-NP nickel plated 36"

40-1870-3/4N nickel plated 3/4 round x 36 spline 24" long

Year

New

47-59 \$144.95

47-59 \$89.95

47-59 \$134.95

\$24.95

\$64.95

\$69.95

\$69.95

\$83.95

\$79.95

## Collapsible Steering Shaft

40-0626-AD 1" DD to 3/4 DD" Adjustable steering shaft 16" to 26" nickel plated

40-0636-AD 1" DD to 3/4 DD" Adjustable steering shaft 24" to 35" nickel plated

\$119.95

\$129.95

## Intermediate Shaft & Flange

40-00SF 9 1/4 w/ rag joint flange -accepts 3/4 DD shaft w/ dust boot- **operates as a collapsible safety shaft**

40-00SR 4" long 3/4 round input end w/rag joint flange end-drill & pin to column shaft (recommend welding tube to shaft)

\$39.95

\$39.95

*Bill's Truck Shop*

Phone (905) 725-3460 / (905) 725-2022 / (905) 404-2302

# STEERING UPGRADES

Year      New

**Steering Shaft –u-joint** when joining new columns to new steering systems (eg 3/4-30 spline to double D shaft)  
 CNC machined Billet Steel- **always drill a dimple in shaft where set screw seats**



41-0UJ1	9/16-26 x 3/4-DD (mustang manual rack)	\$109.95
41-0UJ2	3/4-36 x 3/4 round	\$69.95
41-0UJ3	3/4-30 x 3/4-DD	\$109.95
41-0UJ3-B	3/4 -30 x 3/4 DD BLACK	\$54.99
41-0UJ4	3/4 -36 x 3/4 - 36	\$109.95
41-0UJ5	3/4-36 x 3/4-DD (mustang power rack)	\$79.95
41-0UJ5-B	3/4 36 x 3/4 DD BLACK	\$59.95
41-0UJ6	3/4-DD x 3/4-DD	\$89.95
41-0UJ6-B	3/4 DD x 3/4 DD BACK	\$59.95
41-0UJ7	3/4 DD x 1-DD	\$79.95
41-0UJ9	13/16-36 x 3/4-DD	\$79.95
41-0UJ16	3/4-DD x 3/4 smooth	\$109.95
41-0UJ17	3/4 DD x 17MM	\$109.95
41-0UJ18	3/4- 36 x 1-DD	\$109.95
41-0UJ24	3/4-30 x 1-DD	\$109.95
41-0UJ26	1DD x 1-DD	\$109.95
41-00SS	3/4 steering shaft support	\$39.95

**Double Steering u-joint**

41-0DUJ6	3/4DD x 3/4“ DD	\$179.95
41-0DUJ32	3/4-36 x 3/4“DD	\$199.95
41-0DUJ98	1” DD x 3/4”DD	\$179.95
41-0DUJ98-B	1” DD x 3/4“ DD black	\$89.95

41-00SS



**Steering Shaft Support**

41-00SS	3/4 steering shaft support	\$39.95
---------	----------------------------	---------

*Bill's Truck Shop*

Phone (905) 725-3460 / (905) 725-2022 / (905) 404-2302

# STEERING UPGRADES

Year      NEW

**41-0RJ30**



**41-0SC36**

**Steering Rag Joint**

41-0RJ30	1"DD x 3/4 -30 spline	\$134.95
41-0RJ36	3/4 -36 x 11/16 -36	\$134.95
41-0RJ36-3/4DD	3/4"DD x 11/16 -36 spline	\$134.95
41-0RJ366-3/4DD	3/4 DD x 3/4-36 spline	\$134.95
41-0RJ36-1DD	1"DD x 3/4 -36 spline	\$134.95
41-0RJ366-1DD	1DD x 11/16 -36 spline	\$134.95
41-0RJ10	1"DD x 3/4" DD	\$134.95

**Steering Rag Joint (mini 2 7/8 OD)**

41-0RJ24-M	1"DD x 3/4 30 spline	\$114.95
41-0605S	3/4 DD x 3/4 30 spline x 3/4 round- includes drift pin	\$79.95

**45-0PSCV**



**Steering Shaft Coupler**

41-0SC36	3/4 DD x 3/4 x 36	\$75.00
----------	-------------------	---------

**15-0301**



**Power Rack Control Valve w/ adapt fitting**

45-0PSCV	when using early power steering pumps on mustang steering rack—reduces amount of fluid flow	\$24.95
----------	------------------------------------------------------------------------------------------------	---------

**angle mount**



**Power Steering Pump Bkt kit- fits small block  
Chev w/ long or short neck water pump-will  
require additional crank pulley**

15-0301		\$69.95
---------	--	---------

*Bill's Truck Shop*

Phone (905) 725-3460 / (905) 725-2022 / (905) 404-2302

# STEERING UPGRADES

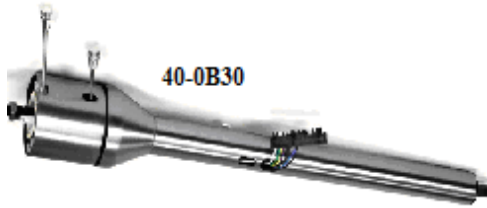

40-0B30



40-0B33-S



3-0010-3

40-0CS-2x2.5



40-0LCS



40-0LCS-4



## IDIDIT Steering Columns

Year   New

Includes dash & firewall support-4 way flasher-self cancelling signals-1"DD output shaft-8 position tilt-w/shift has NO neutral safety switch   US made includes dash mount and floor support 2.5 shaft OD

40-2754-ATB	auto w/ tilt-black	47-55	Inquire
40-2754-TB	no shift-tilt-black	47-55	Inquire

**Tilt Columns-w/ new style GM signal switch**  
NO P/N-rev switch

### UNIVERSAL APPLICATION

**Includes shift levers & indicator w/ shift-use your OE support -add support bushing # 5-0316 & lower column seal #7-308-4**

40-0B33-S	Tilt Column-33"/black -auto-1" DD shaft	\$699.95
40-0B32	Tilt column-32"/black-no shift/1"DD shaft	\$699.95
40-0B32-S	Tilt Column-32"/black - <b>auto</b> -1" DD shaft	\$699.95
40-0B30	Tilt Column-30"/black- <b>no shift</b> /1"DD shaft	\$699.95
40-0B30-S	Tilt Column-30"/black -auto-1" DD shaft	\$699.95
40-0B33-S	Tilt column-33" /black w/ aut 1" DD shaft	\$699.95

**Shift Indicator**-required on all columns   acrylic-stick on

3-0010-3	w/3 speed auto	\$44.95
3-0010-4	w/4 speed auto	\$44.95

### Upper Column Support w/ 2" tube

40-0CS-2x2.5	polished aluminum	47-59	\$99.95
--------------	-------------------	-------	---------

### Lower Column Support

40-0LCS	swivel polished w/ 2" shaft	\$104.95
40-0LCS-4	adjustable swivel 2" shaft	\$63.95

*Bill's Truck Shop*

Phone (905) 725-3460 / (905) 725-2 (905) 404-2302

# STEERING UPGRADES

Year      New

## REPLACEMENT STEERING WHEELS

*Steering Wheel-comfort grip-black includes mounting hub-Chev horn cap-horn contact plate and mounting screws*

\$369.95

**5-5625** Classic GM styled brushed stainless steel 3-spoke steering wheel with black cushioned grip. Includes chrome horn button with Chevrolet Bowtie. 15 inches diameter with 4 1/2" dish.

5-5625-P Horn Contact Plate w/ comfort steering wheel

\$36.95

5-5625-H Hub-steering wheel mounting

\$89.95

5-5625-C Cap-horn cap-Chev black/red/white details

\$79.95

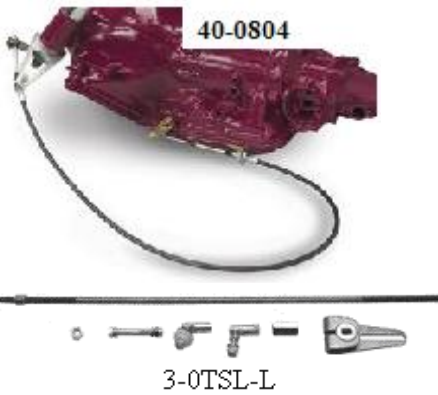
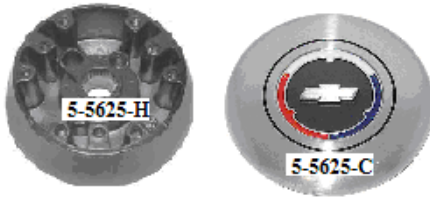

40-0804

**Transmission shift kit –GM 2 “ column mount/ 6’ cable w/all bkts & hdw---** TH350, TH400, 700-R4, TH200, 200-R4, 4L60 and 4L80E

\$119.95

**Automatic Shift Linkage kit**-universal linkage from column bracket to trans-used on installation of newer columns - stainless steel

3-0TSL-L

\$94.95

*Bill's Truck Shop*

Phone (905) 725-3460 / (905) 725-2022 / (905) 404-2302

# PERFORMANCE UPGRADES

Year      New



**19-0412**  
**Torque Converter Lockup Kit**, Pressure Switch, In-line Fuse, GM, 200-4R, 700R4, Kit

\$179.95

50-0155



50-0142



15-0810



**Power Steering Pulley**

15-0508    Double pulley/nut on-replaces GM 3941107  
 15-0810    single groove-press on-back spaced-replaces GM 3834720

\$69.95

\$69.95

**Water Pump Pulley**

50-0155    5.5" in w/6" outer double pulley @ water pump  
 2 ¼ hole spacing replaces GM # 14023155  
 50-0142    6" double pulley -w/ short neck water pump w/  
 1 ¾ hole spacing replaces GM # 3995642

\$129.95

\$94.95

**Phone (905) 725-3460 / (905) 725-2022 / (905) 404-2302**

# PERFORMANCE UPGRADES

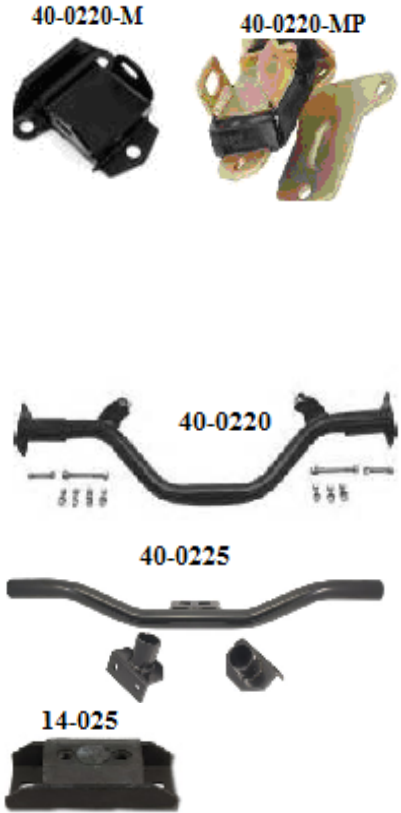

Year      New

**V8 Crossmember.**

40-0220    Adapts GM small block motors to early truck frames      47-59      \$119.95

**V8 Motor Mount** Use with V8 Crossmember,  
 40-0220-M    OE rubber style      \$22.95

40-0220-MP    polyurethane w/zinc frame    each      \$64.95

**Transmission Cross member** Use to install standard or automatic transmissions

40-0225      47-59      \$119.95

**Rear Transmission Mount Pad**

14-025      use with std / PG / 350/700 trans      \$26.95

14-025-1      turbo 400      \$34.95

*Phone (905) 725-3460 / (905) 725-2022 / (905) 404-2302*



Power steering pitman arm when converting to power steering box  
45-0759PA-PS standard height \$59.95  
45-0759PA-PR reversed for lowered trucks \$74.75

I



update your existing axle to any 3-inch diameter rear end. This kit also contains provisions for modern shock absorber mounting-welding required  
47-54 Rear Axle Conversion kit  
45-24RCK \$199.95  
45-24RAS axle seat only pair \$21.95



**1947-54 Chevy Pickup Truck 4-Link Suspension Kit, Complete**

45-24LINK-----\$1895.00

**1947-54 Chevy & GMC----- Lowers your truck 4-6"**

- Truck and GMC Truck coil-over 4-link rear suspension provides the best ride for any Classic truck. These 4-link kits attach directly to the stock frame rails and the adjustable axle brackets let you set the height in one of three positions. A bolt-in upper coil-over crossmember is included. All brackets are made from 1018 mild steel. Our 4-link bars are double adjustable and made from DOM tubing. The double adjustable feature not only allows for precise rear end positioning, but allows you to adjust your pinion angle as well-plain steel items require welding

**INCLUDES**

- Upper Shock Crossmember (Black Powder Coated)
- Frame Brackets (Black Powder Coated)
- Axle Mount Brackets (Plain steel)
- Panhard Bar (Weld On, Zinc Coated Bar, Plain Brackets)
- 4 Bars Set (Zinc Coated)
- Coil-over Shocks (Aldan American)
- All hardware



47-55 Frame **mount brake booster**-bolts in the stock location-- includes 7" dual diaphragm booster, master cylinder, proportioning valve, mount bracket w/pedal & hardware-disc/ drum application-brake lines will need modifying—**for auto trans application-standard trans may require modification**

45-2BBD-8 drum-drum & disc/drum application w/ pedal \$519.95

45-2BBD-8S disc-disc & disc-drum application when using **original brake pedal**

\$624.95



47-55 Firewall mount **brake booster**-bolts in the stock location using supplied pedal-includes 8" dual diaphragm booster, master cylinder, proportioning valve, mount bracket w/ hardware

**1947-1953**

45-23FBB drum – drum application \$519.95  
 45-23FBB2 disc-disc & disc- drum application \$624.95

45-23FB Firewall brake bracket kit w/ pedal \$299.95

**1954-1955**

45-23FBB2-54 disc – drum application Inquire  
 45-23FBB2-54-4 disc – disc application Inquire  
 45-23FBB-54 drum – drum application Inquire



# HARDWARE

49-0610	5/16-18 x 7/8 w/11/16 floating washer-NC	each	\$1.65
49-0612	5/16-18 x 1 w/7/8 floating washer-NC	each	\$2.10
49-0613	5/16 -18 x 3/4 w/ washer head -NC	each	\$2.25
49-0614	3/8-16 x 1 w/1 floating washer-NC	each	\$2.05
49-0615	3/8 -16 x1 1/2 w/ 1 1/8 floating washer NC	each	\$3.25

49-0620	5/16 -18 x 3/4 w/ OE style washer head	each	\$1.65
49-0621	5/16 -18 x1 1/16 dog point w/ floating washer-each		\$1.75

49-0710	5/16 - 18 U - nut	each	\$1.50
---------	-------------------	------	--------

49-0124	1/2 External tooth lock washer -flywheel bolts	each	\$0.35
---------	------------------------------------------------	------	--------

### BODY ALIGNMENT SHIMS -galvanized steel

20-000D	1/16 w/ 3/8 slot shim	each	\$1.25
20-000E	1/8 w/ 3/8 slot shim	each	\$1.45
20-000K	8 pc Shim kit 4 x 1/16 and 4 x 1/8	set of 8	\$10.95

### Totally Stainless bolt kits

Every Body Kit includes component kits-for Front Bumper, Door Hinges, Door Latch & Catch, Fender to Firewall Brace Rods, Front & Inner Fenders, Grill & Gravel Pan, Headlight & Parking Lens, Hood Hinges, Hood Latch, Catch & Braces, Interior, Outside

Mirror, Radiator Support, and Regulator & Relay.

49-2383	47-51 Chev -Body Bolt kit- 18-8 stainless steel w/ indented hex bolts-OE style/cab forward does not include bed any bed hdw		\$399.95
---------	-----------------------------------------------------------------------------------------------------------------------------	--	----------

49-2386	52-53 Chev -Body Bolt kit- 18-8 stainless steel w/ indented hex bolts-OE style /cab forward does not include bed any bed hdw		\$399.95
---------	------------------------------------------------------------------------------------------------------------------------------	--	----------



*Bill's Truck Shop*

Phone (905) 725-3460 / (905) 725-2022 /

