

Nov-2024

Bill's Truck Shop Limited

CHEV GMC
1ST DESIGN
1947-1955
1ST DESIGN
BUY TRADE
SELL

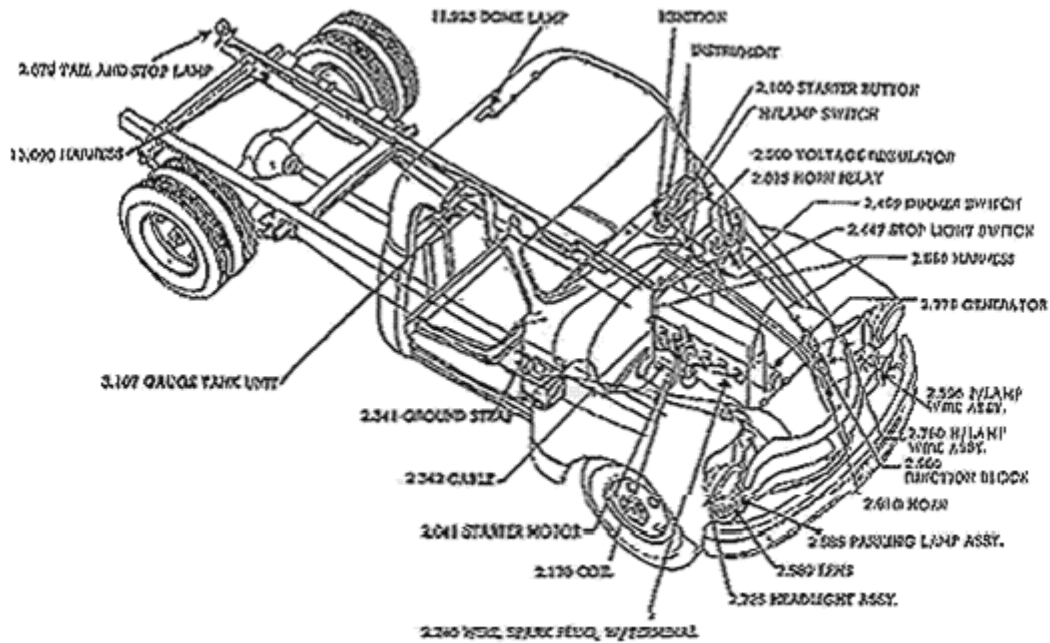

Phone: (905) 725-3460, (905) 725-2022

Fax: (905) 404-2302

web: billstruckshop.com

Email: bill@billstruckshop.com, rob@billstruckshop.com,

aaron@billstruckshop.com

GENERAL INFORMATION

Ordering Information: Please make sure you are ordering the correct parts. Verify page numbers and part numbers upon ordering. On larger orders please fax (905) 404-2302, email at bill@billstruckshop.com / rob@billstruckshop.com / aaron@billstruckshop.com or call for more information.

Payment: We accept VISA, MasterCard, Money Orders, E-Transfers, Personal and Company cheques. Payment plans also available on large restoration. Applicable taxes apply to all sales.

Shipping: Ship by your choice of Canpar, UPS, FedEx, Canada Post, or truck carrier on some large items. Most orders can be shipped same day for next business day delivery. Actual shipping charges will be applied. Also a \$10.00 COD surcharge applies.

Pricing: Prices are in Canadian currency. Due to constant fluctuation between the Canadian and U.S. dollar –refer to the prices in the catalogues as a **GUIDE ONLY!** Bill's Truck Shop Limited Ltd., reserves the right to make appropriate changes as necessary. We try to keep prices low by keeping a large inventory on hand at all times. WE never buy parts with YOUR money to sell to YOU so we never pre-charge you for normal stocking items that are out of stock.

Returns and Guarantees: If fault is found in the parts or workmanship of item purchased, full money back guarantee or exchange for new item. If fault occurs from installation or misuse, no return will be given. No refunds will be given on electrical components or literature. Call with any questions.

Back Orders: No shipping charges will be applied to regular stocked items, unless a manufacturer's back order applies. All back orders cancelled after 60 days.

Discounts: Business's may apply for discounts after providing valid business info. Regular customer discounts can be applied depending on volume purchases / monthly specials and payment type. (E.g.: 3% discount on cash sales - on applicable items only) Check our website for monthly specials.

Parts: There is an ever increasing supply of reproduction parts; they are not always listed in the catalogues. New items can be viewed on our website, www.billstruckshop.com or call for info.

Used Parts: Unlike many other parts suppliers we stock or locate many parts that are not reproduced. We import parts from (California) and bring back trucks, beds, cabs etc. Bill's Truck Shop Limited has made a commitment to supply many new and used parts for your restoration and as a result we are the largest truck part supplier in Canada. NO discounts on used parts. We also will take your used parts in on trade.

Hours of Operation:

Monday to Friday 8:00am to 5:00pm EST

Saturday 8:00am to 1:00pm – Confirm by appointment

Sunday and holidays –Closed

NOTE: IF DRIVING LONG DISTANCE TO VIEW OUR INVENTORY, PLEASE CALL AHEAD

Weather-stripping-Hardware

Group 1



1-201-S



1-0150-C

1-0207-B

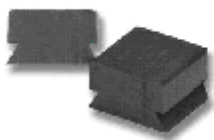

1-0207



1-204-2

Windshield -Deluxe will accept stainless steel trim

		<u>Year</u>	<u>New</u>	<u>Used</u>
1-201-S	standard-does not accept trim	47-53	\$94.95	
1-201-D	deluxe accepts trim	47-53	\$99.95	
1-201-54S	standard- does not accept trim	54-55	\$79.95	
1-201-54D	deluxe accepts trim	54-55	\$79.95	

Corner Glass Weather-strip (pair)

1-0150-B	w/ black lock strip	47-55	\$49.95	
1-0150-C	w/ chrome lock strip	47-55	\$59.95	

Rear & Corner Glass Weather-strip

1-0150-B	w/ black lock strip	47-66	\$49.95	
1-0150-C	w/ chrome lock strip	47-66	\$59.95	

Lock Strip per ft 7/16 W x 7/32W

1-0500	chrome replacement-sold per ft	47-66	\$3.00	
1-0748	black replacement-sold per ft	47-66	\$1.50	

Panel & Suburban Rear Glass Weather-strip

1-0204	seal for rear glass in doors and upper hatch - universal type----- cut ½ for rear door glass	47-59	\$59.95	
1-0204-OE	vulcanized 1 pc OE style for rear barn door glass ----- each	47-59	\$56.95	

Door Link Arm Bumper-Panel/Suburban

1-0207-B	rear barn door upper check arm bumpers-USA made pair	47-59	\$39.95	
----------	--	-------	---------	--

Rear Valance Seal-panel & suburban

1-0207	between rear bumper and rear valance	47-59	\$26.95	
--------	--------------------------------------	-------	---------	--

Suburban Side Window Weather-strip Kit

1-204-2	kit does 4 sliding side windows	47-55	\$379.95	
---------	---------------------------------	-------	----------	--

Bill's Truck Shop

Phone (905) 725-3460 / (905) 725-2022 / Fax (905) 404-2302 email: bill@billstruckshop.com

Weather-stripping-Hardware

Group 1

Used

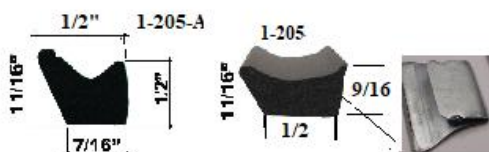
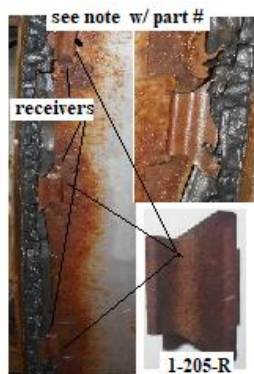

may require slotting seal for clip-secures seal to inner door frame NOT pushing to outer edge



Door Rubber Seals Glues to edge of door-view pictures provided-we have found over the years that 2 diff thickness door seal were used-order as required

1-205	11/16 tall x 1/2 wide base	Precision brand	47-55	\$35.00
1-205-A	11/16 tall x 7/16 base	-used on Canadian built trucks w/ seal retainer -off shore brand		
(1-205-R)	receivers at door hinge end of door	(see below)	47-55	\$9.95
1-0205-R	panel & suburb rear cargo dr seal	- pr	36-66	\$35.00

Lower Door Seal Retainer

1-205-1	steel	each	47-55	\$14.95
1-205-1SS	stainless steel	each	47-55	\$22.95

Retainer Screw Kit -2drs

1-205-SK		16 pcs	47-55	\$5.95
1-205-SKSS	stainless steel	16 pcs	47-55	\$6.95

Door Seal Retainer @ roll @ ft & rear of door

1-205-SR	-prevents seal from coming of roll	pr	47-55	\$4.95
1-205-R	47-53 Retainer-door-ft inner	each	48-55	\$3.25

Late 1948 to 55 1st had metal receivers spot welded on the door shell (@ front between door hinges) for the clips to slide into -this helped prevent door seal from coming off --may require slotting seal for clip when using NEW seals as they are thicker then OE-this part is on Canadian built trucks only

Door Bumper 2 doors

1-206-47		4pcs	47-51	\$4.95
1-206-52		2pcs	52-55	\$4.25
1-206-CS	door bumper set 4 surb-panel w/ clam shell		47-55	\$27.95

Bill's Truck Shop

Phone (905) 725-3460 / (905) 725-2022 / Fax (905) 404-2302 email: bill@billstruckshop.com

Weather-stripping-Hardware

Group 1



Super Weather-strip Adhesive-black

1-0WA \$16.95

Glass Setting Tape - for door and vent glass

1-0GST 1/12 W x 0.062 thick per foot \$2.30
 1-0GST-1 1/12 W x 0.047 thick per foot \$1.95

Cab Wind lace Rubber- on cab door opening

1947- Early '49 held w/ screw-on retaining strip.
 Late 49-54 w/ weld-on steel track.----colours are special order

	Pair		
1-211-47B	black	47-49	\$39.95
1-211-B	black	49-55	\$99.95
1-211-GT	grey/tan	49-55	\$99.95
1-211-DB	dark blue w/ dlx cab	54-55	Inquire
1-211-DG	dark green w/ dlx cab	54-55	Inquire

Wind lace Retainer on cab-47-50 retainer is held to cab w/ screws and 50-55 is welded to cab w/ seal inserted in groove NOTE the 50-55 style retainers can be installed on 47-50 w/ 50-55 style windlace

1-211-47			47-50	
1-211-50LU	upper	L	50-55	Inquire
1-211-50LF	front	L	50-55	Inquire
1-211-50R	rear -	fits L or R	50-55	\$36.00
1-211-50RU	upper	R	50-55	\$26.00
1-211-50RF	front	R	50-55	\$36.00
1-211-50-LK	3 pc kit for	left side	Late49-55	\$119.95
1-211-50-RK	3 pc kit for	right side	Late 49-55	\$119.95

To replace partial pc on ft or rear retainer use upper retainer

Lower Cab Wind lace Rubber – pair

Edge of floor at door opening ----colours are special order

1-212-47B	black	47-49	\$21.95
1-212-B	black	49-55	\$29.95
1-212-GT	grey/tan	50-55	\$34.95
1-212-DB	dark blue	50-55	\$34.95
1-212-DG	dark green	50-55	\$34.95

1947 to 1950 doors do not have vent windows

1951 First year for vent window and last for turn

Down door handles

Inquire about parts not listed

Bill's Truck Shop

Phone (905) 725-3460 / (905) 725-2022 / Fax (905) 404-2302 email: bill@billstruckshop.com

Weather-stripping - Hardware

Group 2

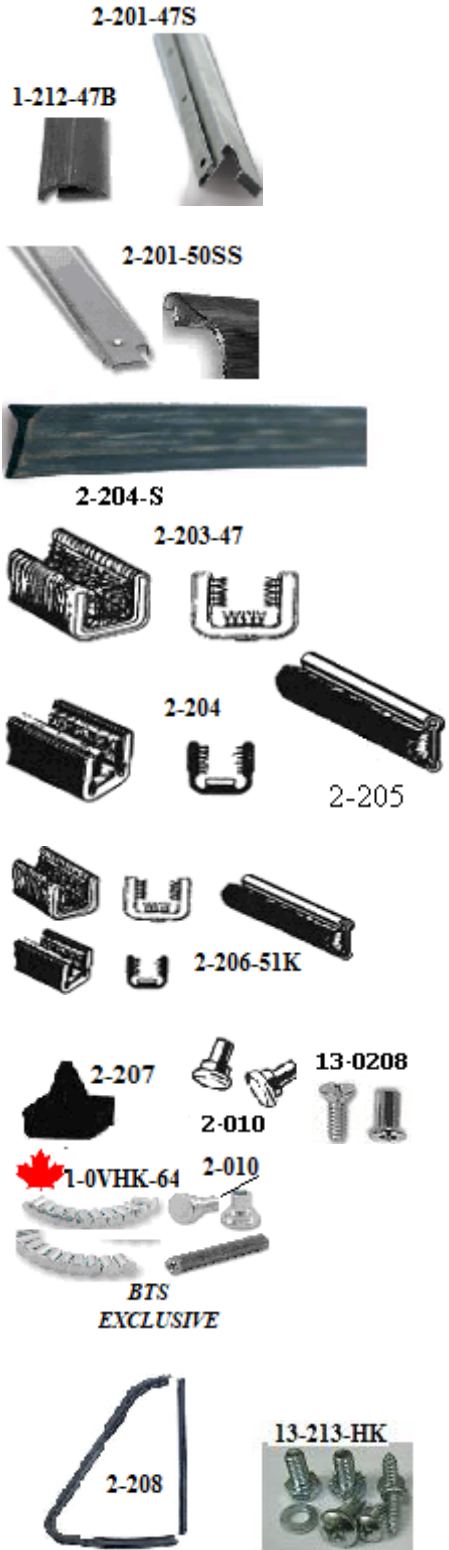

			<u>Year</u>	<u>New</u>
Lower Windlace Retainer -floor edge @ door.(each)				
2-201-47S	steel		47-49	\$24.95
2-201-47SS	stainless steel		47-49	\$39.95
2-201-50S	steel		49/50-55	\$14.95
2-201-50SS	stainless steel		49/50-55	\$32.95
Lower Wind lace Retainer Screws				
2-201-2SS	(16) - stainless steel		47-49	\$5.95
2-201-3SS	(8) - stainless steel		50-55	\$2.25
Door Glass Channel Runs -felt lined steel track for door glass				
2-203-47	w/o vent windows	pair	47-50	\$149.95
2-203-47-1	w/o vent windows	each	47-50	\$75.95
2-203-50	w/ vent window	pair	51-55	\$74.95
Division Bar Relining Channels-felt lined				
2-204		pair	51-55	\$59.95
Outer Window Rubber Seal				
2-204-S	fits on outer horizontal track inside door	pair	47-55	\$13.95
Door Window Inner &Outer Seals With Clips				
2-205-47		4 pcs	47-50	\$56.95
2-205-51		4 pcs	51-55	\$56.95
Door Glass Felt Kit-felt lined steel core w/ in-outer scraper				
2-206-47K	includes 203-47/205-51	6pcs	47-50	\$224.95
2-206-51K	includes 203-50/ 204/ 205-51	8pcs	51-55	\$189.95
Window Stop Bumper				
2-207		pair	47-55	\$4.95
Vent Window Weather-strip				
2-208	original design -	pair	51-55	\$64.95
Vent Assembly Pivot Rivets				
2-010			51-55	
2-010	pivots glass frame on assembly-	pair	64-87	\$6.25
Vent Assembly Kit-includes assembly , pivot rivets & tool				
1-0VHK-64	1951-55 and 64-87		51-87	\$16.95
Vent Window install hardware kit				
13-213-HK	9 pcs	per side	51-55	\$5.95
Door Glass Frame Screws (barrel nut & screw)				
13-0208	47-50 requires 4 per window	each	47-61	\$1.50

Bill's Truck Shop

Phone (905) 725-3460 / (905) 725-2022 / Fax (905) 404-2302 email: bill@billstruckshop.com

Vent Window - Cowl-Seals

Due to the fluctuation of the Canadian and American dollars call for current prices

Group 2



Door Hinge Seals

3-020-S panel/suburban w/ barn doors-set of 4

Year New Used

36-59 \$36.95

Top Cowl Vent assembly

2-215

47-53 \$249.95 \$100.0

2-215-54

54-55 \$125.0

Top Cowl Vent Hdw install kit

2-215-HK 18 pcs

47-53 \$8.95

2-215-4HK 20 pcs

54-55 \$8.95

Top Cowl Vent Gasket

2-215-1 sponge

47-53 \$7.95

2-215-2 sponge

54-55 \$7.95

Top Cowl Vent Drain Hose

2-215-3

47-55 \$6.95

Cowl Vent Knob-top vent and 47-50 side vent

2-215-M Maroon

47-53 \$13.95

2-215-B Black

54-55 \$12.95

Side Cowl Vent Assembly

3-201 on drivers side of cowl

47-50 \$75.00

Side Cowl Vent Gasket

3-201-S sponge

47-50 \$5.95

Side Cowl Handle Cover w/gasket

3-201-C w/machine screws like OE

47-50 \$21.95

Side Cowl Handle Gasket

3-201-G

47-50 \$4.25

Side Cowl Springs-pr

3-201-DS

47-50

Bill's Truck Shop

Phone (905) 725-3460 / (905) 725-2022 / Fax (905) 404-2302 email: bill@billstruckshop.com

Seals/Hardware-Fender-Hood-Doors

Group 3



3-204

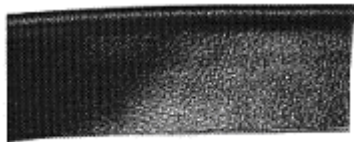

3-205



3-206



3-206-1



3-21RS



3-21FSS

Inner/Outer Fender Seal Kit

3-204 w/instructions 47-55 \$32.95

Outer Fender Weld Beading @ Cowl

3-205 6ft 47-55 \$6.00

Firewall to Fender Panels

Top of inner fender to firewall

3-206 1/2-3/4 and 1 ton pair w/ screws 47-55 \$16.95

3-206-1 1 1/2 ton up pair w/ screws 47-55 \$16.95

Front Fender Braces-fender to cab approx. 10 1/2 long 1/2, 3/4 & 1 ton

3-21FS steel/ front pair 47-55 \$36.95 \$15.00

3-21FSS stainless steel / front pair w/ hdw 47-55 \$42.95

Rear Fender Braces 11" long w/ short step

3-21RS steel / rear- short step pair 47-55 \$35.95 \$10.00

3-21RSS stainless steel / rear -short step pair w /hdw 47-55 \$74.95

3-21RS-P steel-panel/surban pair 47-55 \$18.95

3-21RS-L rear fenders approx 17" long w/ long step 47-55 Inquire

Bill's Truck Shop

Phone (905) 725-3460 / (905) 725-2022 / Fax (905) 404-2302 email: bill@billstruckshop.com

Hood Parts

Due to the fluctuation of the Canadian and American dollars call for current prices

Group 3

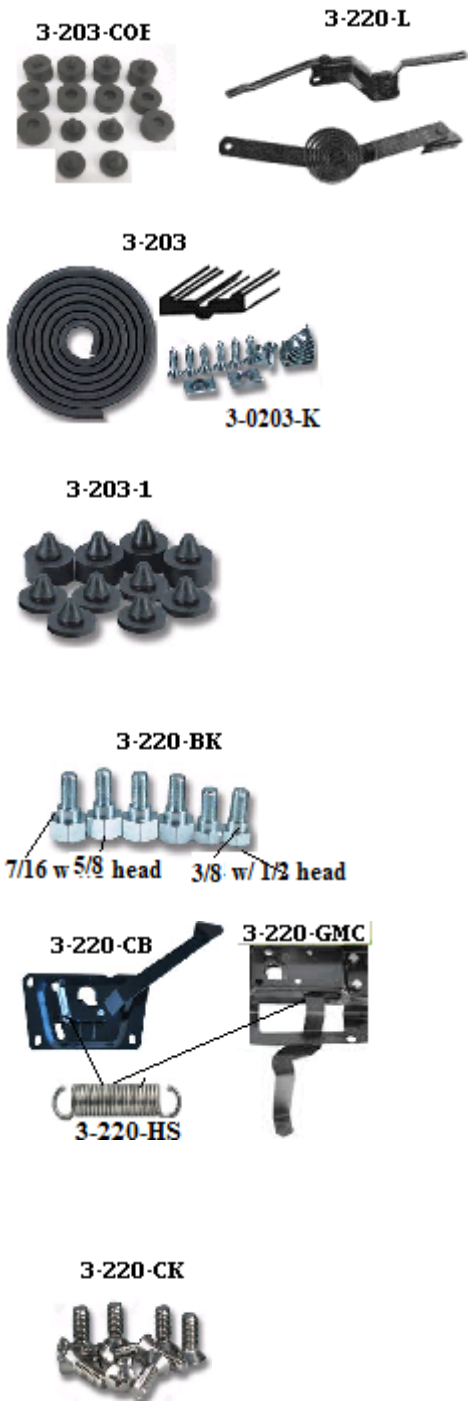

		<u>Year</u>	<u>New</u>	<u>Used</u>
Hood to Cowl Seal with hardware				
3-203	includes retainers & screws	47-55	\$15.95	
Cowl Seal Hardware kit				
3-0203-K	8 retainers w/ screws	36-55	\$4.95	
Hood Bumper Set				
3-203-1	may require urethane to secure 10 pcs- ----GMC hood side only	47-55	\$8.95	
3-203-COE		47-55	\$24.95	
3-203-G	GMC truck @ front of hood each	47-55	Inquire	
Hood Hinge w/ spring				
3-220-L	2 pc left	47-55	\$94.95	
3-220-R	2 pc right	47-55	\$94.95	
Hood Hinge Bolt Kit				
3-220-BK 4 x 7/16 collar and 2 x 3/8 collar Some early 1947 & early 48 w/ original hinges --- bolt size-maybe all 7/16 collar-- same also applies to COE trucks-all replacement hinges take the later bolt kit				
3-220-BK-47	6 x 7/16 collar bolts w/ OE	47 early	\$20.95	
	hood hinges	48	\$21.95	
3-220-7/16	hood hinge bolt each	47-55	\$3.00	
3-220-3/8	hood hinge bolt each	47-55	\$3.00	
Hood Release Assembly				
3-220-CB	black - Chev	47-55	\$90.95	\$30.00
3-220-CC	chrome - Chev	47-55	\$119.95	
3-220-GMC	GMC	47-55	\$119.95	\$40.00
Hood Release Handle Return Spring				
3-220-HS	ecures handle in lock position Chev & GMC	47-55	\$3.25	

Bill's Truck Shop

Phone (905) 725-3460 / (905) 725-2022 / Fax (905) 404-2302 email: bill@billstruckshop.com

Hood Parts

Due to the fluctuation of the Canadian and American dollars call for current prices

Group 3

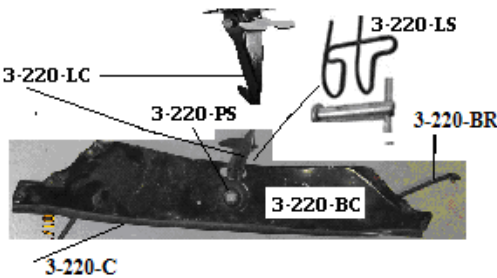
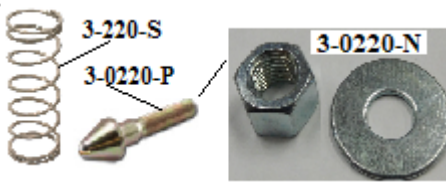

Safety Catch Assembly – second safety catch

3-220-LC	bolts on front of hood brace	Chevy & GMC	47-55	\$109.95
----------	------------------------------	-------------	-------	----------

Safety Catch Handle Spring w/ clevis pin –NEW

3-220-LS	on secondary hood safety catch		47-55	\$19.95
----------	--------------------------------	--	-------	---------

Hood Lock Pin and spring

3-0220-P	pin		47-55/67-74	\$12.95
3-220-S	spring		47-55	\$5.95

Hood Lock Pin- lock nut & washer

3-0220-N				\$1.50
----------	--	--	--	--------

Hood Latch @ Lock Pin Brace

3-220-BC	supports hood halves @ latch @ ft of hood-Chev		47-55	\$125.00
3-220-BG	supports hood halves @ latch @ ft of hood-GMC		47-55	\$125.00

Hood Brace Bolt kit @ front of hood

3-220-CK	stainless steel countersunk bolts to secure brace to hood halves and rods	ashers & nuts included -18pcs	Chev	47-55	\$9.95	
3-220-GK	stainless steel countersunk bolts to secure brace to hood halves		GMC	6 screws	47-55	\$4.95

Hood Support Rods w/ hardware

3-220-BL	right	Chev hood only		47-55	\$29.95
3-220-BR	left	Chev hood only		47-55	\$29.95

Hood Support @ rear of hood

3-220-RL	drivers side			47-55	\$75.00
3-220-RR	pass side			47-55	\$75.00

PICTURE

Bill's Truck Shop

Phone (905) 725-3460 / (905) 725-2022 / Fax (905) 404-2302 email: bill@billstruckshop.com

Dash Gauges

Due to the fluctuation of the Canadian and American dollars call for current prices

Group 4



4-200-47



4-200-47G



4-247-SCG



4-250-SC



4-254-C



2-204-1



2-204-2

47-49 Chev & 47-51 GMC high beam indicator is @ bottom and 50-53 Chev & 52-53 GMC is @ the top
Speedometer Gauge -please check that the needle clears the glass on install

		<u>Year</u>	<u>New</u>
4-200-47	Chev 80 MPH w / white needle	47-49	\$259.95
4-200-47RN	Chev 80 MPH w/ red needle	47-48	\$259.95
4-200-47G	GMC 80 MPH w/ red needle-tan background	47-51	\$259.95
		50-53-C	
4-200-50	Chev/GMC 90 MPH w / white needle/grey background	52-53-G	\$259.95
4-200-54	Chev	54-55	\$224.95
4-200-54G	GMC w/square dash	55-55	

Speedo Cluster Assembly

Complete new gauge cluster assemblies with either 6 or 12 volt and 6 or 8 cyl application-confirm needle & background colour---**EARLY 1947 dash cluster mount ears are 4 3/4 dist apart-later are 6"**

4-247-SC	Chev only 0-80 mph w/ white needle & letters high beam indicator @ bottom grey/brown background	47-48	\$369.95
4-247-SC-R	Chev only 0-80 mph w/ red needle w/ white letters high beam indicator @ bottom grey/brown background	47-48	\$429.95
4-247-SCG	GMC 0-80 mph w/ red needle-high beam indicator @ bottom cream back ground	48-51	\$369.95
		50-53-Chev	
4-250-SC	Chev & GMC 0-90 mph w/ white needle-gray/brown background - high beam indicator is @ top Oil gauge square nut must be secured when installing oil line-failure do to so will damage gauge-----NO WARRANTY	52-53-GMC	\$399.95
4-254-SC	54-55 Chev & 54 GMC 0-90 mph	54-55	\$399.95

Gauge Decal Kit Die-cut nylar decals in correct size,

shape & colour -Speedometer, odometer, and all 4 gauges			
4-204	80 MPH Chev w/ dark face-white numbers-high beam indicator @ bottom	47-49	\$22.95
4-204-1	80 MPH GMC w/ cream face w/ dark numbers	47-51	\$22.95
4-204-2	90 MPH Chev-GMC w/ dark face-white numbers-high beam indicator @ top	50-53	\$22.95
4-204-3	Chev black /light green	54-55	\$15.95
4-204-4	GMC w/ round cluster	55-55	\$31.00
4-0304-G	late 1st series 55 w/ square cluster	55-59	\$23.95

Bill's Truck Shop

Phone (905) 725-3460 / (905) 725-2022 / Fax (905) 404-2302 email: bill@billstruckshop.com

Dash Gauges

Due to the fluctuation of the Canadian and American dollars call for current prices

Group 4

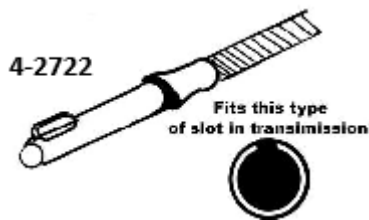
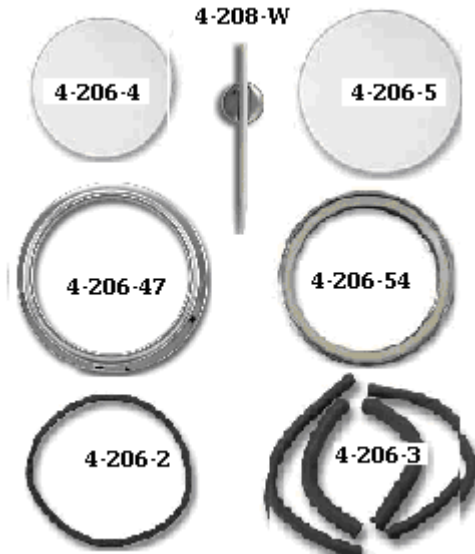

Speedo and Gauge Bezel

			Year	New	Used
4-206-47	chrome	each	47-53	\$21.95	
4-206-54	54-55 Chev&54 GMC stainless steel	each	54-55	\$39.95	

Speedo and Gauge Bezel Gaskets at bezel glass

4-206-2			47-53	\$2.95	
4-206-3			54-55	\$3.50	

Speedo and Gauge Glass

4-206-4		each	47-53	\$7.95	
4-206-5		each	54-55	\$7.95	

Speedometer Needle

4-208-R	red/orange	47-48-Chev/47-51 GMC	47-53	\$11.95	
4-208-W	white	49-53 Chev/52-53 GMC	49-53	\$9.95	

Speedometer Cable

4-0SCP	70 " w/ plastic housing		47-72	\$22.95	
4-0SCS	w/ steel casing 70 "		47-72	\$22.95	
4-0SCP-0	w/ plastic casing 75"		47-72	\$33.95	
4-0SCP-1	w/plastic casing 85"		47-72	\$52.95	
4-0SCP-2	w/plastic casing 100"		47-72	\$52.95	

4-2722	metal cable w/ key drive		38-55	\$112.95	
--------	--------------------------	--	-------	----------	--

Speedometer Cable Grommet

4-0208-5	cut on angle to center to install over cable		47-55 60-72	\$2.50	
----------	--	--	----------------	--------	--

Bill's Truck Shop

Phone (905) 725-3460 / (905) 725-2022 / Fax (905) 404-2302 email: bill@billstruckshop.com



4-210-50-12



4-210-VR



4-210-VRA



4-250-T8

4-247-T6G



4-0250-B



CONFIRM BACKGROUND & NEEDLE COLOUR

There have been some issues w/ the repro gauges as they have the pin style sweep needle instead of the inner sweep needle (see picture) and making contact w/ the upper gauge inner bezel-this requires removing some of this bezel for the needle to clear

Year New

Fuel Gauge –battery “in” post on the “E” side of the gauge
OE “F” fuel sender/tank side w/ 0 - 30 ohms fuel sender// **dash assembly must be grounded before testing**

4-210-47-6	Chev	w/ red needle-6volt	47-49	\$119.95
4-210-47-12	Chev	w/ red needle-12volt	47-49	\$119.95
4-210-50-6	Chev	w/ white needle-6volt	50-53	\$119.95
4-210-50-12	Chev	w/ white needle-12volt	50-53	\$119.95
4-210-54-6	Chev	w/ 6 volt	54-55	\$119.95
4-210-54-12	Chev	w/ 12 volt	54-55	\$119.95
4-210-55	1 st GMC			
4-210-47-G6	GMC	w/ red needle-6 volt	47-51	\$119.95
4-210-47-G12	GMC	w/ red needle-12 volt	47-51	\$119.95
4-210-50-6	GMC	w/ white needle-6volt	52-53	\$119.95
4-210-50-12	GMC	w/ white needle-12volt	52-53	\$119.95

Fuel Gauge Volt Reducer

4-210-VR	electronic reducer for gauges from 12 to 6 volts	47-55	\$22795
----------	--	-------	---------

Voltage Reducer when changing to 12 volts

4-210-VRA	universal style	47-55	\$5.95
-----------	-----------------	-------	--------

Temperature Gauge w/tubing V8 tube is 60 in long

4-247-T6	Chev	w/ 6 cyl-red needle-45”tube 100-212 deg-	47-49	\$122.95
4-247-T8	Chev	-w/ 8cyl-w/red needle-60” tube 100-220 deg -	47-49	\$122.95
4-250-T6	Chev	w/ 6cyl-w/white needle-45”tube 100-212 deg	50-53	\$122.95
4-250-T8	Chev	w/ 8cyl-w/white needle-60”tube 100-220 deg	50-53	\$122.95
4-254-T6	Chev	for 6 cyl engine-45 “ tube	54-55	\$122.95
4-254-T8	Chev	for 8 cyl engine-60 “ tube	54-55	\$122.95
4-255-T6	1 st GMC			55-55
4-247-T6G	GMC	w/ 6 cyl-red needle 45”tube 100-220 deg	47-51	\$122.95
4-247-T8G	GMC	w/ 8 cyl-red needle 60”tube - 100-220 deg	47-51	\$122.95
4-250-T6	GMC	w/ 6cyl-w/white needle-45”tube 100-212 deg	52-53	\$122.95
4-250-T8	GMC	w/ 8cyl-w/white needle-60”tube 100-220 deg	52-53	\$122.95

Temp Gauge Bushing

4-0250-B	brass bushing to adapt temp line to newer cyl head		\$12.95
----------	--	--	---------

NO WARRANTY ON GAUGES IF INSTALLED INCORRECTLY

Bill's Truck Shop

Phone (905) 725-3460 / (905) 725-2022 / Fax (905) 404-2302 email: bill@billstruckshop.com

Dash Gauges

Due to the fluctuation of the Canadian and American dollars call for current prices

Group 4

4-250-060



4-247-0



5-0LK

41-0249-A



4-250-V



4-247-V



4-0200-K



4-253-SK



Oil Gauge- you must secure the gauge nut when tightening oil line to gauge-no warranty on broken gauges

4-247-O	Chev -red needle -30 lbs w/ 6 cyl	47-49	\$99.95
4-247-O60	Chev -red needle-60 lbs w / 8 cyl	47-49	\$109.95
4-250-O	Chev -white needle 0- 30lbs w/ 6 cyl	50-53	\$99.95
4-250-O60	Chev -white needle 0- 60lbs w/ 8 cyl	50-53	\$109.95
4-254-O	Chev 0 - 60 lbs	54-55	\$109.95
4-255-O	1st GMC	55-55	
4-247-OG	GMC w/ red needle -60 lbs	47-51	\$99.95
4-250-O	GMC -white needle 0 -30lbs w/ 6 cyl	52-53	\$99.95
4-250-O60	GMrft5C -white needle 0 -60 lbs w / 8cyl	52-53	\$99.95

Oil Line kit

5-0LK	5 ft copper tubing w/ correct fittings	47-55	\$32.95
-------	--	-------	---------

Oil Line Block kit - 3 pc set

41-0249-A	2 outlet plug for oil gauge and filter line-screws in block	47-62	\$13.95
41-0249-1	1/8 pilot nut		\$1.65
41-0249-2	1/8 tube OD x 1/8 male pipe-gauge only		\$4.95
41-0249-3	1/8 NPT 3 outlet female		\$4.95
41-0249-4	1/ 8 x 1" connector tube		\$4.95

Voltage / Amp- Battery Gauge

4-247-V	Chev w/ red needle	47-49	\$99.95
4-250-V	Chev w/ white needle	50-53	\$199.95
4-254-V	Chev w/ white needle	54-55	\$109.95
4-255-V	1st GMC	55-55	
4-247-VG	GMC w/ red needle	47-51	\$76.95
4-250-V	GMC w/ white needle	52-53	\$99.95

NOTE-battery wire secures to pin on "D" side of gauge

Dash Gauge Insulator/warning Label kit

4-0200-K		47-59	\$1.75
----------	--	-------	--------

Dash Cluster hdw kit-secures cluster to dash studs

4-253-SK	8 nuts w/ washers	47-55	\$2.50
----------	-------------------	-------	--------

Bill's Truck Shop

Phone (905) 725-3460 / (905) 725-2022 / Fax (905) 404-2302 email: bill@billstruckshop.com

Dash Gauges Clusters

Due to the fluctuation of the Canadian and American dollars call for current prices

Group 4



4-247-SCG



4-250-SC



4-254-C



4-250-6C12



4-247-6G6



4-254-6C12

late 54 to 55 1st GMC



Speedo Cluster Assembly-

4-247-SC	Chev only 0-80 mph w/ white needle-high beam indicator @ bottom grey/brown background	48-49	\$369.95
4-247-SCG	GMC 0-80 mph w/ red needle-high beam indicator @ bottom cream back ground	48-51	\$369.95
		50-53-Chev	
4-250-SC	Chev & GMC 0-90 mph w/ white needle-gray/brown background – high beam indicator is @ top	52-53-GMC	\$399.95
Oil gauge square nut must be secured when installing oil line-failure do to so will damage gauge-----NO WARRANTY			
4-254-SC	54-55 Chev & 54 GMC 0 -90 mph	54-55	\$399.95

Gauge Cluster Assembly 47-49 Chev w / red needle grey/brown background

4-247-6C6	6cyl, 6 volt.0-30lb oil, 100-212 temp	48-49	\$549.95
4-247-8C12	8cyl, 12 volt.0-60lb oil, 100-212 temp	48-49	\$599.95
4-248-6C12	6cyl, 12 volt.0-30lb oil, 100-212 temp	48-49	\$599.95
4-249-6C12	6cyl, 12 volt.0-30lb oil, 100-220 temp	48-49	\$599.95
	GMC red needle w/ cream back ground		
4-247-6G6	GMC 6cyl,6 volt,0-60 lbs oil,100-220 temp	48-51	\$599.95
4-247-6G12	GMC 6cyl,12volt.0-60lbs oil,100-220 temp	48-51	\$599.95
4-247-8G12	GMC 8cyl,12 volt,0-60 lbs oil,100-220 temp	48-51	\$599.95

Gauge Cluster Assembly 50-53 Chev & 52-53 GMC w/ white needle-gray-brown background

		50-53C	
4-250-6C6	6cyl, 6 volt.0-30lb oil, 100-212 temp	52-53G	\$525.00
		50-53C	
4-250-6C6-1	6cyl, 6 volt.0-30lb oil, 100-220 temp	52-53G	\$525.00
		50-53C	
4-250-6C12	6cyl,12 volt.0-30lb oil, 100-220 temp	52-53G	\$599.95
		50-53C	
4-250-6C12-1	6cyl, 12 volt.0-30lb oil, 100-212 temp	52-53G	\$599.95
		50-53C	
4-250-8C12	8cyl, 12 volt.0-60lb oil, 100-220 temp	52-53G	\$599.95
		50-53C	
4-250-8C12-A	8cyl, 12 volt.0-60lb oil, 100-212 temp	52-53G	\$599.95

Gauge Cluster Assembly 54-55 Chev & 54 GMC

4-254-6C6	6 cyl , 6 volt	54-55	\$649.95
4-254-6C12	6 cyl , 12 volt	54-55	\$649.95
4-254-8C12	8 cyl , 12 volt	54-55	\$649.95

Bill's Truck Shop

Phone (905) 725-3460 / (905) 725-2022 / Fax (905) 404-2302 email: bill@billstruckshop.com

Dome Lamp

Due to the fluctuation of the Canadian and American dollars call for current prices

Group 4

Used

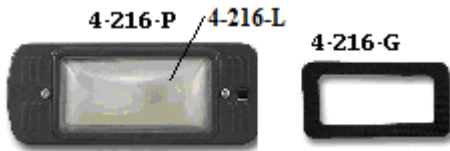

Dome Lamp Assembly w / hdw

4-216-P					
4-216-C					

Dome Lamp Bulb

16-205-DS6					
16-0205-12					

Dome Lamp Lens

4-216-L					

Dome Lamp Lens Gasket

4-216-G					

Dome Lamp Screw kit

4-216-S					

Bill's Truck Shop

Phone (905) 725-3460 / (905) 725-2022 / Fax (905) 404-2302 email: bill@billstruckshop.com

Dash Trim

Due to the fluctuation of the Canadian and American dollars call for current prices

Group 4

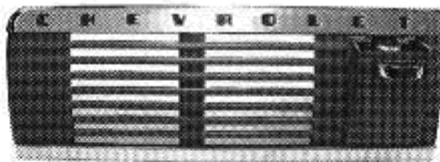

4-220-C

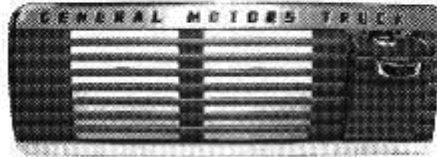

4-220-G



4-223-G

4-221-C



4-221-G



4-222



GMC



CHEV



4-ORIV

Center Dash Speaker Grill w/Ash Tray

	Year	New	Used
4-220-C stainless steel w/painted details includes up & low mld and ashtray w/chrome knob- <i>Chev</i>	47-53	\$199.95	\$100.00
4-220-CB same as above but w/o up & low trim-reusing your original trim	47-53	Inquire	
4-220-G stainless steel w/painted details includes up & low mld and ashtray w/chrome knob- <i>GMC</i>	47-53	\$199.95	\$100.00

Dash Trim –upper mld w/ logo

4-221-C CHEVROLET (Chev)	47-53	\$99.95	\$40.00
4-221-G GENERAL MOTORS TRUCK (GMC)	47-53	\$99.95	\$40.00

Dash Trim – lower mld

4-222 Chev & GMC	47-53	\$65.00	\$30.00
------------------	-------	---------	---------

Dash Trim Decal set

4-223-CB black vinyl /Chev truck CHEVROLET	47-53	\$5.95	
4-223-CW white vinyl /Chev truck CHEVROLET	47-53	\$5.95	
4-223-CR red vinyl /Chevy truck CHEVROLET	47-53	\$5.95	
4-223-G black vinyl/GMC truck GENERAL MOTORS TRUCK	47-53	\$5.95	

I.D. PLATES

-Exact reproduction to replace damaged plates

4-247-C 81.5 HP @ 3100RPM Chev 4600lbs	47-49	\$29.95	
4-247-G GMC open GVW	47-52	\$29.95	
4-250-C 85HP @ 3300 RPM Chev 4600 lbs	50-50	\$22.95	
4-251-C 85HP @ 3300 RPM Chev 4800lbs	51-52	\$36.95	
4-253-C 85HP @ 3300 RPM Chev 4800 lbs	53-53	\$22.95	
Note-47-52 plates were secured w / 2 x clutch drive screws			
4-253-G GMC open GVW	53-54	\$24.95	
4-254-C 105HP @ 3600 RPM Chev	54-55	\$22.95	

RIVETS-@ I.D. Plate-original plug style

4-ORIV pair of original style metal plugs	47-59	\$7.95	
---	-------	--------	--

Bill's Truck Shop

Phone (905) 725-3460 / (905) 725-2022 / Fax (905) 404-2302 email: bill@billstruckshop.com

Column-Dash

Due to the fluctuation of the Canadian and American dollars call for current prices

Group 5



		<u>Year</u>	<u>New</u>	<u>Used</u>
Steering Wheel—all used wheels w/ have some cracks				
5-200-47	black	47-53	\$444.95	\$100.00
5-200-47BR	brown	47-53	Inquire	\$100.00
5-0200-54	black	54-56	\$444.95	\$100.00
Horn Cap – Chevrolet				
5-201-47C	Chev chrome w/ painted details	47-53	\$74.95	\$10.00
5-201-47G	GMC stainless steel w/ painted details	47-53		\$50.00
5-201-54C	Chev chrome w/ painted details	54-55	\$89.95	\$20.00
5-201-54G	GMC stainless steel w/ painted details	54-55		\$75.00
Horn Contact & Cap Retainer				
5-201-2		47-53	\$39.95	
5-0301-3		54-59	\$39.95	
Horn Contact Pin Spring & Bushing				
5-0201-4	12 volt system	47-66	\$12.95	
5-0201-5	6 volt system w/ heavier internal cable	47-55	\$15.95	
Steering Wheel Retaining Nut w/ washer				
5-0230-N		47-72	\$1.95	
Spring-Upper Column Bearing				
5-0201-S		47-59	\$8.95	
Upper Column Bearing (with horn wire)				
18-0311		47-59	\$84.95	
Spinner- Steering wheel (Brodie)				
44-070BT	w/ Chev logo		\$29.95	
Wiper Knob-will not fit new style electric switch				
5-204-47C	chrome	47-53	\$12.95	
5-204-47M	maroon	47-53	\$7.75	
5-204-54C	Chev black	54-55	\$11.95	
5-204-54G	GMC grey	54-55	\$7.95	
Turn signal Lever with Knob				
5-305-1		54-59	\$19.95	
Cable Lock Stop				
5-0209			\$1.75	
Support				
5-0209-S	throttle & choke cable @ carb	47-59		\$20.00

Bill's Truck Shop

Phone (905) 725-3460 / (905) 725-2022 / Fax (905) 404-2302 email: bill@billstruckshop.com

Column-Dash

Due to the fluctuation of the Canadian and American dollars call for current prices

Group 5



		<u>Year</u>	<u>New</u>	<u>Used</u>
Choke Knob				
5-207-K	stainless steel & maroon	47-53	\$16.95	
5-207-4K	black & white	54-55	\$12.50	
Choke Cable w/ Knob				
5-207-8	stainless steel & maroon	47-53	\$28.95	
5-207-4	black & white	54-55	\$26.95	
Throttle Cable w/ Knob				
5-208-8	stainless steel & maroon	47-53	\$29.95	
5-208-4	black w/ white "T"	54-55	\$26.95	
Parking Brake Release Knob				
5-210-47	chrome	47-53	\$14.95	
5-210-54	black w/white B	54-55	\$13.95	
Gearshift Knob				
5-211-M	maroon	48-53	\$15.95	
5-211-54	black	54-55	\$13.95	
5-0211-F	floor shift - black	40-59	\$16.95	
Ashtray Assembly				
5-213	Chev	47-53		\$15.00
5-213-54G	GMC	54-55		\$30.00
5-213-54C	Chev	54-55		\$30.00
Ashtray Knob				
5-213-47	chrome	47-53	\$14.95	\$5.00
Steering Column Support Clamp				
5-216-C47	supports column at dash	47-53		\$50.00
5-216-C54	supports column at dash	54-55		\$50.00
Steering Column Support Bolt Insulator Pads				
5-0216-P	2 required @ support to dash	54-59	\$3.50	
Steering Column Clamp Bushing				
5-216		47-53	\$5.95	
5-216-2		54-55	\$3.95	

Bill's Truck Shop

Phone (905) 725-3460 / (905) 725-2022 / Fax (905) 404-2302 email: bill@billstruckshop.com

Firewall-Floor

Due to the fluctuation of the Canadian and American dollars call for current prices

Group 7

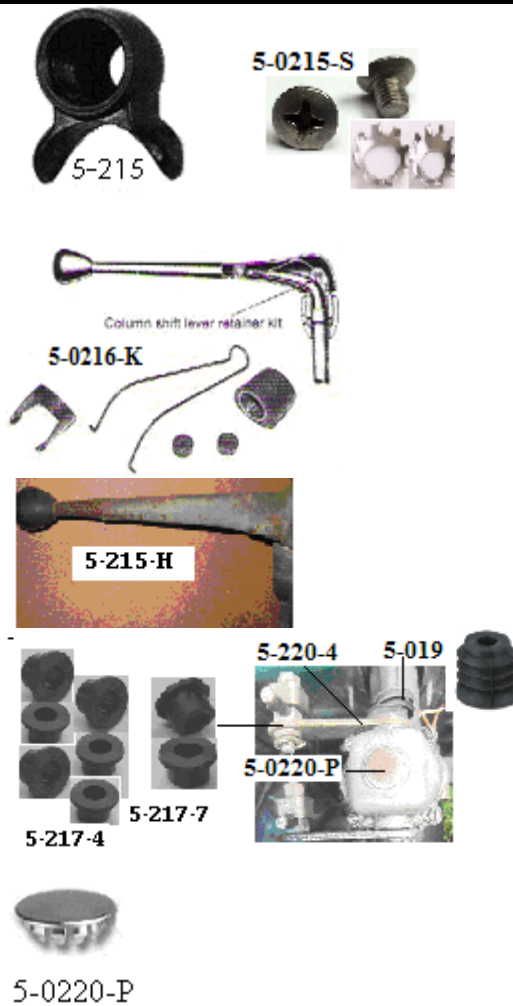

Column Shifter Bracket

5-215 upper column at shifter handle-flange is flush w/ top of bowl

Year New Used

47-55 \$29.95

Column Shift Bracket Screws

5-0215-S ¼ x 28- 3/8 fine thread-stainless steel –we now include external countersunk washer to help prevent screw from coming loose

pair 47-59 \$6.95

Shift Lever

5-215-H

49-55 \$25.00

Column Shift Lever Kit--

5-0216-K includes pins/springs& bushings

47-59 \$34.95

Shift Lever Bushings w/ column shift (rubber)

5-217-4 set of 6

54-55 \$8.95

5-217-7 set of 2 @ shift box

49-53 \$4.50

Shifter Boot at Shift Box

5-019 boot

48-59 \$4.95

5-019-S **spring**-prevents boot from sliding up shaft---OE GM service repair item

48-59 \$9.95

Shifter Box

5-220-8 on column-one arm shorter

48-53 \$50.00

5-220-4 on column-both arms /same length

54-55 \$50.00

Shifter Box Plug

5-0220-P stainless cap on 3 speed shift box

48-55 \$1.95

Spring-shift box selector

5-0220-S

48-59 \$12.95

Bill's Truck Shop

Phone (905) 725-3460 / (905) 725-2022 / Fax (905) 404-2302 email: bill@billstruckshop.com

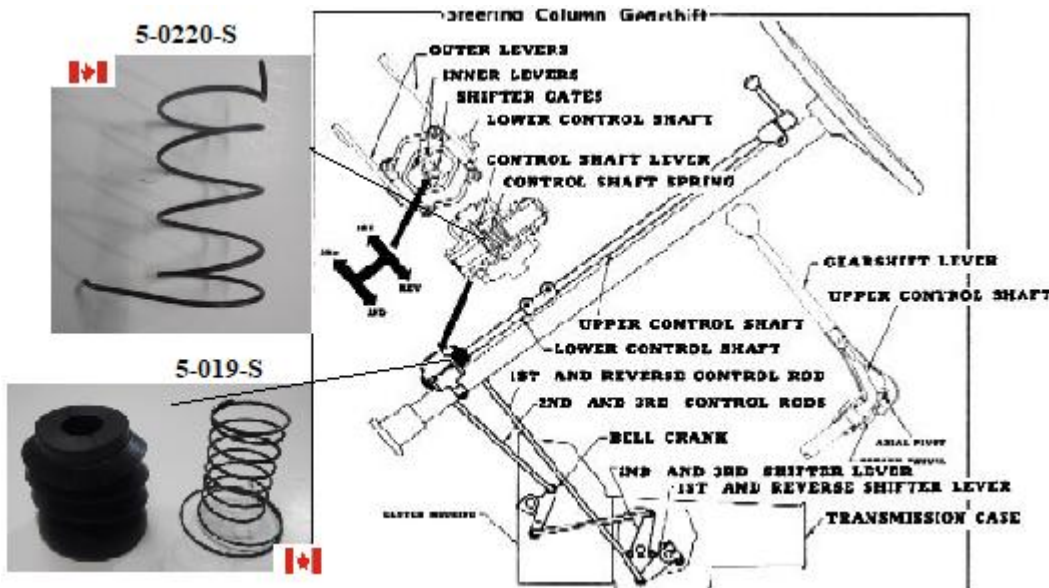

Firewall-Floor

Due to the fluctuation of the Canadian and American dollars call for current prices

Group 7



			<u>Year</u>	<u>New</u>	<u>Used</u>
Accelerator Linkage					
7-200	inquire	buy year & engine	47-55		Inquire
Accelerator Pedal					
7-201-47	accel rod	secures w/ pin	47-52	\$25.95	
7-0301-55	accel rod	pushes into rubber	53-57	\$26.95	
Accelerator Rod Pin					
7-0224	pin w/ cotter	pin-pedal to rod	40-52	\$1.00	
Accelerator Pedal Pivot Pin w/cotter pin					
7-0201-2			52-57	\$5.95	
Accelerator Pedal Shaft Floor Seal					
7-0201-4			41-59	\$4.50	
Accelerator Pedal Pivot w/ stop					
7-0201-5	2 pc	welds to floor	47-57		
Brake & Clutch Pedal Hardware					
47-55	arms-linkage-brackets	etc	47-55		Inquire
Brake-Clutch-Park Brake Pedal Pad					
7-203-1	glue on to prevent pulling off	each	47-55	\$5.95	
Brake & Clutch Floor Shaft Seals					
7-203-47		felt-pr	47-51	\$6.95	
7-203-52		felt-pr	52-55	\$5.95	
Retainer-Brake & clutch seat -w/ weld in holes					
7-203-47R	1 3/4 wide	pair	47-51	\$19.95	
7-203-52R		pair	52-55	inquire	
Clutch-Brake Arm Stop Bumper					
7-003-S	47-53 brake arm only	each	47-59	\$2.95	
Clutch-Brake Arm Stop Bumper					
7-003-S	47-53 brake arm only	each	47-59	\$2.50	
Brake & Clutch Pedal Bushings		(pair)			
7-203-B	brass oversize to repair worn shaft-machine as nec		47-55	\$33.95	

Bill's Truck Shop

Phone (905) 725-3460 / (905) 725-2022 / Fax (905) 404-2302 email: bill@billstruckshop.com

FOR ATTACHMENT SEE
BOOK 3707901-SECTION 1
SHEET 3. 03

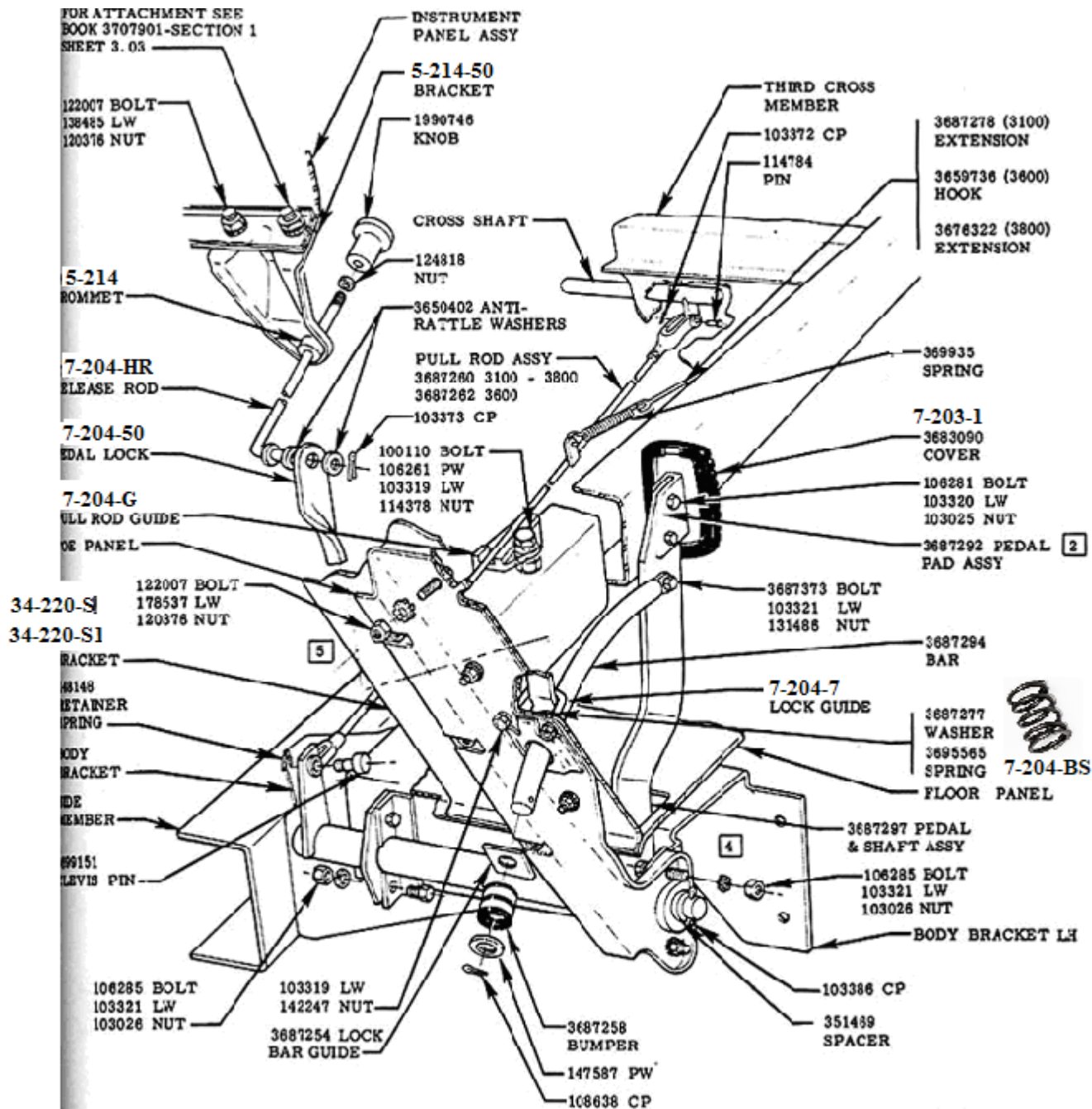

late 1948-55 Park Brake Instruction

MODELS
3102 - 3602 - 3802



		<u>Year</u>	<u>New</u>	<u>Used</u>
Parking Brake Assembly-pedal arm w/support & shaft				
7-204-47	pull handle and hdw	41-48		Inquire
7-204-49	push pedal-rods, linkage	49-55		Inquire
Parking Brake Control Rod-includes rod, clevis and spring-47 has pull lever park brake and early 48-49 had 2 pc rod				
7-204-48R	2 pc short bed	48-50		\$100.00
7-204-R	stainless steel rod short bed	48-55	\$164.95	\$75.00
7-204-RB	steel short bed	48-55	\$89.95	
Parking brake rod clevis w/ pin @ cross bar				
7-204-C	curved end	47-55	\$16.95	
Park Brake Rod Return Spring w/ extension rod				
7-204-RS		48-55	\$19.95	
Parking Brake Rod Guide				
7-204-G	locates rod on frame	48-55	\$9.95	
Pin-cable yoke end				
38-0435	5/ 16 x 1 14	47-55	\$1.45	
Parking Brake Release Lock Guide U-Bolt				
7-204-7	includes hdw	48-55	\$36.95	
Parking Brake Lock				
7-204-48		49-50		\$20.00
7-204-50	w/ twist @ top for release rod	50-55		\$10.00
Parking Brake Release Lock Guide U-Bolt				
7-204-7	includes hdw	48-55	\$33.95	\$10.00
Spring-parking brake bar spring @ firewall				
7-204-BS	OE # 3695565	48-55	\$8.95	
Support-inner fender w/ park brake				
34-220-S	on left firewall for inner fender & park support	48-55	\$89.95	
34-220-S1	new replacement inner to outer fender support when NOT installing the OE style park brake assembly and trucks w/ park at trans-left side	48-55	\$34.95	
NOTE-1947 & early 48 had park brake on floor next to trans shifter & OE in fenders were longer to cab-requires this bkt to install 49-55 inner fender on 47-48 trucks,panels,surburbans				

Bill's Truck Shop

Phone (905) 725-3460 / (905) 725-2022 / Fax (905) 404-2302 email: bill@billstruckshop.com

Firewall-Floor

Due to the fluctuation of the Canadian and American dollars call for current prices

Group 7



	<u>Year</u>	<u>New</u>	<u>Used</u>
Parking Brake Handle Rod			
7-204-HR	48-55		\$15.00
Parking Brake Rod Seal Bumper & Pin			
7-204-1	48-55	\$9.95	
Parking Brake Handle Rod Grommet			
5-214 at column support	48-55	\$1.95	
Parking Rod Support			
5-214-48 48 early 49 is 1 ½ tall w/no grommet	48-49		\$20.00
5-214-50 late 49-55 is 2 ½ tall w/ hdw	49-55		\$15.00
Parking Brake Lever Boot			
7-204-4	48-55	\$11.95	
Parking Brake Lever Boot Retainer			
7-204-5 w/screws (3)	48-55	\$15.95	
Boot Retainer Screws			
7-204-6 stainless –slot head set of 3	48-55	\$0.95	
Cover-park brake pedal w/ screws			
7-204-PC used on all trans park brake & custom park brake	48-55	\$14.95	
Steering Column to Floor Seal w/ flange & screws			
7-208-4 column shift	47-55	\$23.95	
7-208-5 floor shift	47-55	\$23.95	
Column Flange Screw Set			
7-208-6 2 pcs	47-55	\$0.95	
Starter Pedal Assembly			
7-210 linkage-rods etc	47-55		\$75.00
Starter Pedal Pad			
7-0315-P w/ foot pedal start-rubber	47-59	\$6.95	
7-0315-PS original steel pedal w/ knurled top	47-59		\$5.00
Starter Bellows			
7-0315	47-59	\$10.95	
Clutch Head Driver Set			
5-0CHSD-4 4 x screw drivers	47-61	\$33.95	
5-0CHS-4 4 x 3/8 drive sockets	47-61	\$34.95	

Inquire about used parts not listed

Bill's Truck Shop

Phone (905) 725-3460 / (905) 725-2022 / Fax (905) 404-2302 email: bill@billstruckshop.com

Floor-Firewall

Due to the fluctuation of the Canadian and American dollars call for current prices

Group 8



	Year	New	Used
Master Cylinder Access Plug -rubber w/ steel reinforcement-some OE all steel available used			
8-0325	47-59	\$10.95	
Vacuum Hose Firewall Grommet for vac wipers			
8-206 11/ 16 hole dia	47-55	\$2.95	
Main Wire Harness Firewall Grommet			
8-0105	36-59	\$3.95	
Main Supply & Ignition Wire Firewall Grommet -left upper cowl			
8-206-2 starter to ammeter wire & coil wire	47-55	\$1.95	
Four Hole Firewall Grommet			
8-206-3 4 hole-choke-throttle-temp line etc	47-49	\$3.75	
8-206-3R retainer w/ screws for grommet-	47-49		\$10.00
8-0206-4 temp line/choke/throttle fits 1 ' hole	50-59	\$3.95	
Speedometer Cable Grommet			
4-0208-5 cut on angle to center to install over cable	47-55 60-72	\$2.50	
Firewall Grommet kit			
4-47K includes 8-206/8-0105/8-206-2 x 2/8-0206-3 & 4-0208-5 6 pcs	47-49	\$17.95	
8-206-50K includes 8-206/8-0105/8-206-2 x 2/8-0206-4 & 4-0208-5 6 pcs	50-55	\$17.95	
Horn Wire Grommet			
8-206-4 in firewall/dash brace	47-55	\$2.50	

Bill's Truck Shop

Phone (905) 725-3460 / (905) 725-2022 / Fax (905) 404-2302 email: bill@billstruckshop.com

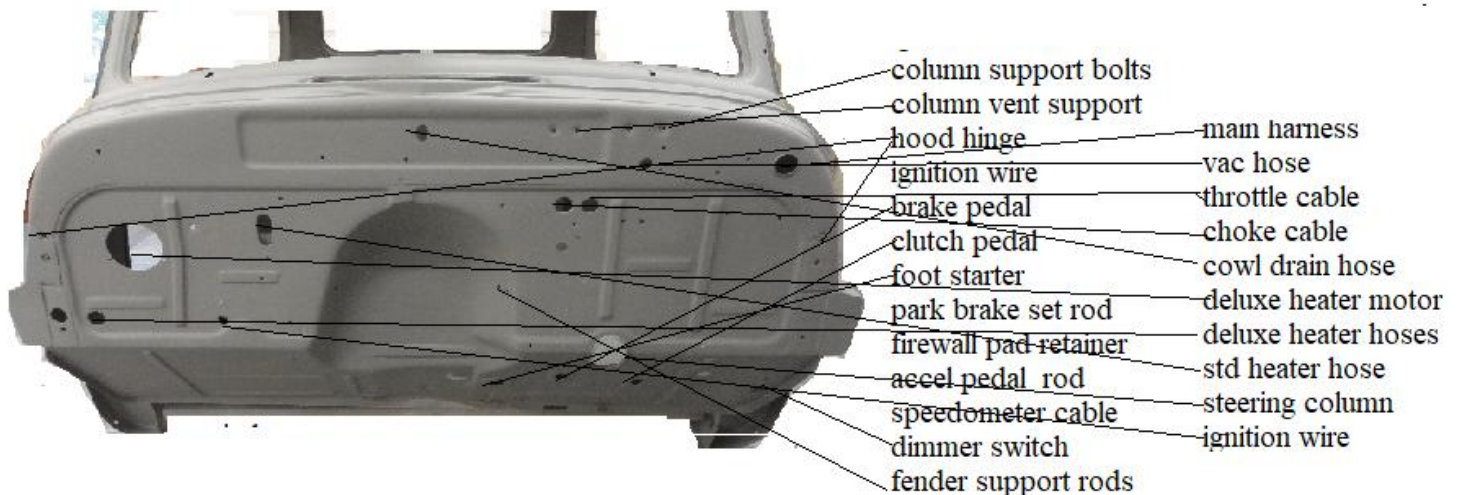

Floor-Firewall

Due to the fluctuation of the Canadian and American dollars call for current prices

Group 8

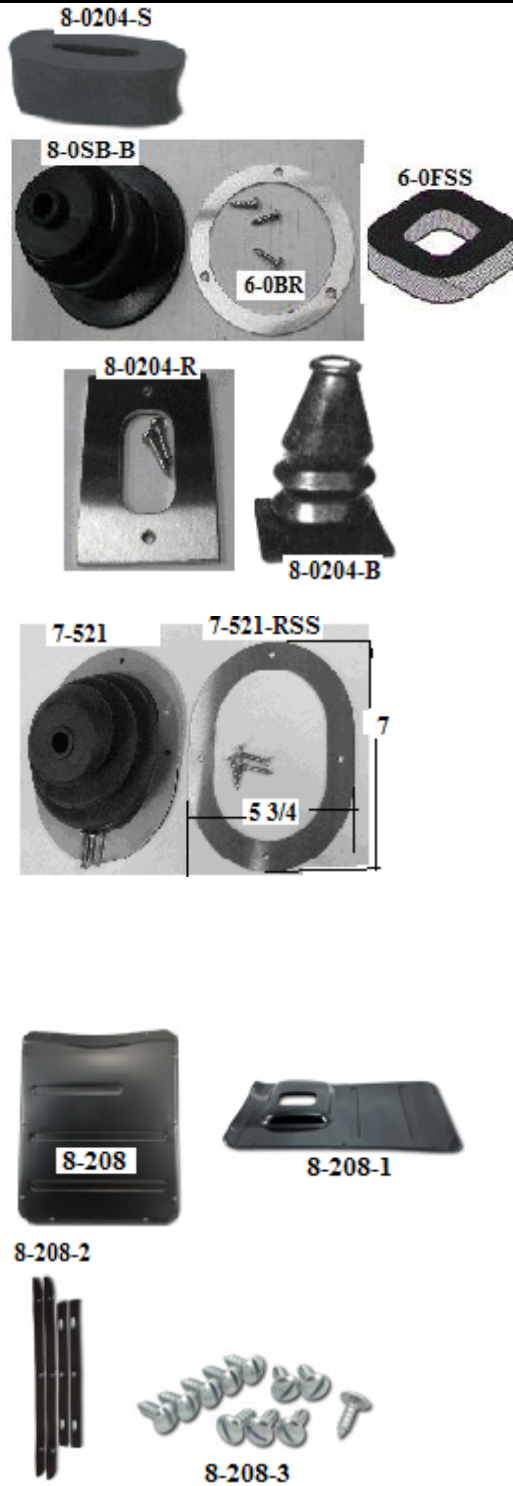

		<u>Year</u>	<u>New</u>	<u>Used</u>
Floor Shift Sponge Seal				
6-0FSS-37	w/ 3 speed floor shift	37-49	\$14.95	
6-0FSS		50-66	\$9.95	
Floor Shift Boot				
8-0SB-C	w/ Chev logo	47-66	\$28.95	
8-0SB-B	w/ no logo	47-66	NLA	
Floor Shift Boot Retainer				
6-0BR	14G brushed stainless steel w/screws	47-66	\$29.95	
Hand Brake Sponge Seal				
8-0204-S	floor mounted	37-59	\$5.50	
Hand Brake Boot				
8-0204-B		47-59	\$18.95	
Hand Brake Boot Retainer w/ screws				
8-0204-R	14G brushed stainless steel w/screws	47-59	\$15.95	
Shifter Boot-replacement for any 4-5 speed std trans				
7-521	Shifter Boot		\$27.95	
7-521-RSS	retainer-stainless steel w/ hdw		\$19.95	
Transmission Floor Cover ½ -1 ton				
8-208	column shift	47-55	\$92.95	\$50.00
8-208-1	4-speed	47-55	\$119.95	\$50.00
8-208-A	w/ automatic trans	47-55		\$150.00
Transmission Floor Cover Gasket				
8-208-2		47-55	\$14.95	
Transmission Floor Cover Screw Set (11)				
8-208-3		47-55	5.95	

Bill's Truck Shop

Phone (905) 725-3460 / (905) 725-2022 / Fax (905) 404-2302 email: bill@billstruckshop.com

Battery Tray - Cables

Due to the fluctuation of the Canadian and American dollars call for current prices

Group 8

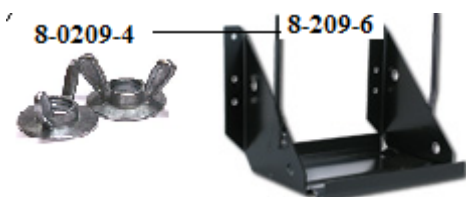

	Year	New	Used
Battery Compartment Cover			
8-209 pickup & panel/suburban and under driver seat - tool storage	47-55	\$124.95	\$80.00
OE Spring-battery cover retainer -secures cover to floor -usually missing on good used covers 2 required for OE covers-does not apply to repro covers			
8-209-S each	47-55	\$11.95	
Battery Cover Seal			
8-209-1	47-55	\$11.95	
Tool Compartment Cover			
8-209-T suburb/panel under right seat	47-55		
Battery Top Hold Down			
8-209-2	47-55	\$30.95	
Battery Hold Down Corner Pad set of 4			
8-209-3	47-55	\$14.75	
Battery Hold Down Nuts			
8-0209-4 wing nuts w/ washer seat--- pair	47-55	\$1.75	
Battery Tray Bottom			
8-209-5	47-55	\$23.95	
Battery Box - frame mount assembly			
8-209-6 9 1/4 wide x 7 1/4 deep	47-55	\$84.95	
Battery Box Shield on Frame			
8-209-7	47-55		\$25.00
Ground Strap-Battery braided strands as original			
8-0462 Battery to Frame 14"	47-59	\$39.95	
8-0463 Engine to Frame 12"	47-59	\$34.95	
Battery Positive Cable			
8-201-B #1 gauge w/o black cloth cover 34" long	47-55	\$44.95	
8-201-BS #1 gauge 34" long cloth covered	47-55	\$59.95	
NOTE-- the lower # gauge wire the bigger the wire is in size-important when using 6 volt systems			
Battery Cable End-replacement clamp style			
8-0880 battery cable end		\$3.95	
Battery Cable Cover-top post/slip on			
8-0760-R red/positive		\$2.95	
8-0760-B black/neg		\$2.95	

Bill's Truck Shop

Phone (905) 725-3460 / (905) 725-2022 / Fax (905) 404-2302 email: bill@billstruckshop.com

Glove Box Door/Dash

Due to the fluctuation of the Canadian and American dollars call for current prices

Group 9

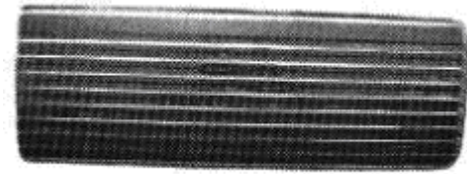

9-201



9-201-1



9-201-47T



9-201-6



9-201-47H

5-0GBB



9-201-11

5-0224

9-201-H



9-201-9

9-201-7

5-0222

5-0223



9-0201-13



5-0GBL

9-201-L

		<u>Year</u>	<u>New</u>
Glove Box Door			
9-201	Chev-GMC –stainless steel w/painted details	47-53	\$169.95
9-201-SS	Chev-GMC/ stainless steel	47-53	\$169.95
9-201-54G	GMC	54-55	
Glove Box Hinges			
9-201-47H	pr of side arms w/hdw	47-53	\$63.95
9-201-54H	@ bottom of door	54-55	Inquire
Glove Box Hinge Screw set			
9-201-47HS	arm screw set 8 pcs w/ washers	47-55	\$4.95
Glove Box Liner – cardboard- assembled with clip nuts installed & screws			
9-201-1	Chev	47-49	\$29.95
9-201-1G	GMC	47-49	\$29.95
9-201-2	Chev / GMC	50-53	\$29.95
9-201-3	Chev	54-55	\$29.95
9-201-4	GMC	54-55	\$29.95
Glove Box Screw set			
9-201-6	9 screws	47-49	\$3.95
9-201-5	6 screws	50-55	\$5.95
Glove Box Liner Trim w/ screws			
9-201-47T	replacement retainer that hold liner to dash-22 gauge satin coat steel-paint as required-NEW satin coat	47-49	\$16.95
Glove Box Door Bumpers			
5-0GBB	pair	47-72	\$2.50
Glove Box Lock & Key w/ original style key			
9-201-7		40-53	\$37.95
5-0221	w/o key	54-72	\$26.95
5-0222	w/ 2 keys	54-72	\$43.95
9-201-54	OE has 1 1/8 outer trim	54-55	
Glove Box Lock Gasket			
9-201-9		47-53	\$0.95
5-0223		54-72	\$1.25
Glove Box Lock Retainer Bracket W/ Screws			
9-201-11		47-53	\$8.95
5-0224		54-72	\$3.95
Glove Box Lock Striker w/screws			
9-0201-13		54-59	\$8.95
Glove Box J-Hook & Slide			
9-201-H		47-53	\$4.95
Glove Box Light Kit			
9-201-L	switch, support & harness	47-53	\$34.95
5-0GBL		54-72	\$19.95

Bill's Truck Shop

Phone (905) 725-3460 / (905) 725-2022 / Fax (905) 404-2302 email: bill@billstruckshop.com

Interior Parts

Due to the fluctuation of the Canadian and American dollars call for current prices

Group 10

10-201-BN



10-201-6A 10-201-6



10-201-4S

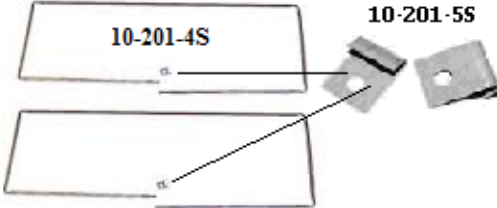

10-201-5S



10-203-BK



10-203-G



10-204-S

9-0773-AN



9-0773-AS

Door Panels Pre-cut cardboard punched panels-pair

Standard comes in flat finish

		<u>Year</u>	<u>New</u>	<u>Used</u>
10-201-BK	black	47-55	\$24.95	
10-201-BN	brown	47-55	\$24.95	
10-201-LG	light grey	47-55	\$24.95	

Deluxe Leather Style grain (pair)

10-202-BK	black	47-55	\$44.95	
10-202-BN	brown	47-55	\$44.95	
10-202-M	maroon	47-55	\$44.95	
10-202-G	grey	47-55	\$44.95	
10-202-BU-special order	blue	47-55	\$44.95	
10-202-GN-special order	green	47-55	\$44.95	

Door Panel Metal Frames w/ clips (pair)

10-201-4S	steel/zinc coated	47-55	\$48.95	
10-201-4SS	stainless steel	47-55	\$79.95	

Door Panel Metal Frame Clips (pair)

10-201-5S	steel	47-55	\$3.25	
10-201-5SS	stainless steel	47-55	\$3.50	

Door Panel Fasteners

10-201-6	stainless steel screws & washers	47-53	\$9.95	
10-201-6A	brown push in clips/ 12	54-55	\$9.95	

Kick Panel (pair)

10-203-BK	black	47-55	\$34.95	
10-203-BN	brown	47-55	\$34.95	
10-203-G	grey	47-55	\$34.95	

Arm Rest w/ instruction & hdw-black bases -- each

10-204-BK	black	47-55	\$69.95	
10-204-BN	brown	47-55	\$69.95	
10-204-M	(special order) maroon	47-55	\$69.95	
10-204-G	grey	47-55	\$69.95	
10-204-BG	(special order) blue/green	47-55	\$79.95	

Armrest Support Plate-steel plate to reinforce plastic base

10-204-S	each	47-55	\$18.95	
----------	------	-------	---------	--

Armrest Screw

9-0773-AS	¼ x 20 x 1 1/4 Philips screw	pair	47-72	\$2.00
-----------	------------------------------	------	-------	--------

Armrest Nut

9-0773-AN	cage nut	pair	47-72	\$4.95
-----------	----------	------	-------	--------

Bill's Truck Shop

Phone (905) 725-3460 / (905) 725-2022 / Fax (905) 404-2302 email: bill@billstruckshop.com

Interior Parts

Due to the fluctuation of the Canadian and American dollars call for current prices

Group 10

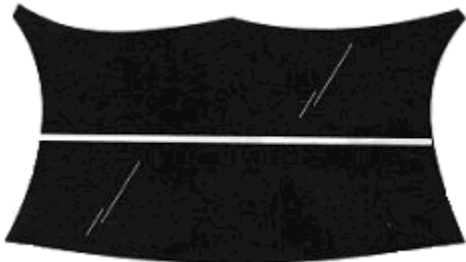

10-205



10-208-BK



10-201-BK

Headliner Cut to exact size.
49's specify screw-in center bow (early type) or floating center bow (late type)

Rear section 16 deep

		<u>Year</u>	<u>New</u>	<u>Used</u>
10-205-BK	black	47-early 49	\$74.95	
10-205-BN	brown	47-early 49	\$74.95	
10-205-LG	light grey	47-early 49	\$74.95	
10-205-PB	pearl beige	47-early 49	\$74.95	
10-206-BG	blue/green > special order	47-early 49	Inquire	

Rear section 14 " deep

10-206-BK	black	late 49-53	\$74.95	
10-206-BN	brown	late 49-53	\$74.95	
10-206-LG	light grey	late 49-53	\$74.95	
10-206-BG	blue/green > special order	late 49-53	Inquire	
10-206-PB	pearl beige	Late 49-53	\$74.95	
10-207-BK	black	54-55	\$74.95	
10-207-BN	brown	54-55	\$74.95	
10-207-LG	light grey	54-55	\$74.95	
10-207-PB	pearl beige	54-55	\$74.95	
10-207-BG	blue/green > special order	54-55	\$74.95	

Panel Truck 2 pc set-----**SPECIAL ORDER**

10-208-BK	black	47-early 49	\$119.95	
10-208-BN	brown	47-early 49	\$119.95	
10-208-LG	light grey	47-early 49	\$119.95	
10-208-BK-50	black	late 49-53	\$119.95	
10-208-BN-50	brown	late 49-53	\$119.95	
10-208-LG-50	light grey	late 49-53	\$119.95	

10-209-BK	black	54-55	\$119.95	
10-209-BN	brown	54-55	\$119.95	
10-209-LG	light grey	54-55	\$119.95	

Suburban 5 pcs

10-210-BK	black	47-53	\$279.95	
10-210-BN	brown	47-53	\$279.95	
10-210-LG	light grey	47-53	\$279.95	
10-211-BN	brown	54-55	\$279.95	
10-211-BK	black	54-55	\$279.95	

Bill's Truck Shop

Phone (905) 725-3460 / (905) 725-2022 / Fax (905) 404-2302 email: bill@billstruckshop.com

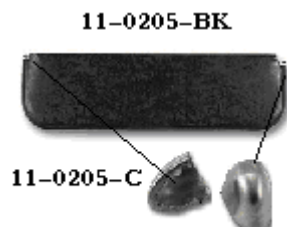
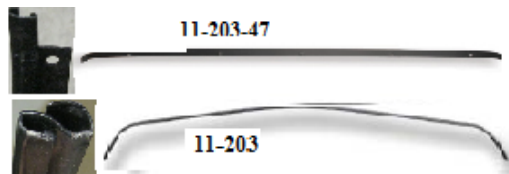
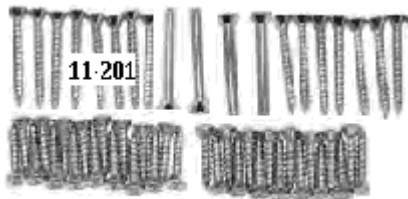

include w/ new visors

includes screws w/ new



Interior Trim Screw Kit

windshield & door inner trim-stainless steel

Part Number	Quantity	Year	New	Used
11-201	51 pcs	47-53	\$19.95	
11-201-54	33 pcs	54-55	\$8.95	

Center Headliner Retainer

Part Number	Description	Year	New	Used
11-203-47	secured w/ 7 screws	47-early 49	\$59.95	\$30.00
11-203	floating "S"	49-55	\$59.95	\$35.00

Rear Headliner Retainer

Part Number	Description	Year	New	Used
11-203-47R	secured w/ 7 screws	47-early 49		\$60.00
11-203-50R	secured w/ 11 screws	49-55	\$64.95	\$50.00

Headliner Retainer Screw Kit

Part Number	Description	Quantity	Year	New	Used
11-203-C	center retainer-stainless steel	(7)	47-49	\$2.50	
11-203-R	rear retainer- stainless steel	(10)	47-49	\$2.95	
11-203-50	rear- black	(11)	49-55	\$4.95	
11-203-50S	rear- stainless steel	(11)	49-55	\$5.95	

Covered Sun Visor w/ end clips each

Part Number	Color	Year	New	Used
11-0205-BK	black	47-59	\$49.95	
11-0205-BR	brown	47-59	\$49.95	
11-0205-G	grey	47-59	\$49.95	
11-0205-M	maroon	47-59	\$49.95	
11-0205-R	red	47-59	\$49.95	

Sun Visor End Clips Stain- steel end clips for uncovered visor

Part Number	Quantity	Year	New	Used
11-0205-C	pair	47-66	\$3.50	

Sun Visor Bracket includes screws-bright chrome like finish NOT like OE

Part Number	Side	Year	New	Used
11-205-L	left	47-53	\$31.95	\$10.00
11-205-R	right	47-53	\$31.95	\$10.00
11-205-1L	left	54-55	\$31.95	\$10.00
11-205-1R	right	54-55	\$31.95	\$10.00

Sun Visor Bracket Screw kit

Part Number	Quantity	Year	New	Used
11-0205-2	3 pcs	47-59	\$1.25	

1955 year is 1st series not second series 1955-59

Bill's Truck Shop

Phone (905) 725-3460 / (905) 725-2022 / Fax (905) 404-2302 email: bill@billstruckshop.com



11-207-BKV



11-207-K



madrid vinal



11-0SC

Seat Cover-Sierra grain—USA made

			<u>Year</u>	<u>New</u>	<u>Used</u>
11-207-BKV	black	vinyl	47-55	\$235.00	
11-207-BNV	brown	vinyl	47-55	\$235.00	
11-207-GRV	grey	vinyl	47-55	\$235.00	
11-207-BMV	maroon Sierra grain	vinyl	47-55	\$235.00	
11-207-BKF	black	fabric	47-55	Inquire	
11-207-BNF	brown	fabric	47-55	Inquire	

SEAT COVERS

Seat Cover *Heavy Duty vinyl similar to original colour and grain w/stitched foam backing for pleating Madrid vinyl inquire about other colour combinations---USA made*

11-206-DSV	dark saddle non-pleated vinyl		47-55	\$379.95	
11-206-DSV-P	dark saddle pleated vinyl		47-55	\$379.95	
11-206-BKV-P	black pleated vinyl		47-55	\$379.95	
11-206-BKV	black non-pleated vinyl		47-55	\$379.95	
11-206-MV-P	maroon pleated vinyl		47-55	\$379.95	
11-206-MV	maroon non-pleated vinyl		47-55	\$379.95	

GMC – French Stitching

11-207-F	special order		47-49 50-55	Inquire	
----------	---------------	--	-------------	---------	--

Seat Upholstery Installation Kit

11-207-K	includes burlap and cotton padding		47-55	\$29.95	
----------	------------------------------------	--	-------	---------	--

Seat to Frame Clip kit







11-0SC	70 pcs		37-59	\$18.50	
--------	--------	--	-------	---------	--

Bill's Truck Shop

Phone (905) 725-3460 / (905) 725-2022 / Fax (905) 404-2302 email: bill@billstruckshop.com

Interior-Seats-hardware

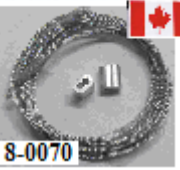
Group 11

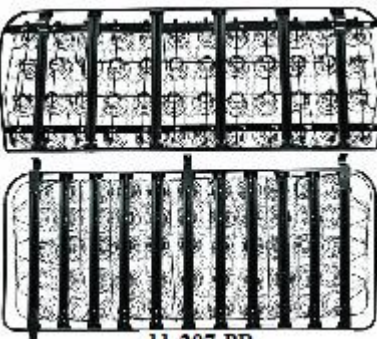
		<u>Year</u>	<u>New</u>	<u>Used</u>
<p>11-208</p>  <p>11-0209</p> 	<p>Seat Frame Bumpers and Screws between upper seat frame and cab.</p>			
	11-208 pair	47-55	\$8.95	
<p>11-0307-S</p> 	<p>Seat Adjustment Rod Grommet</p>			
	11-208-1	50-54	\$4.25	
<p>11-208-1</p> 	<p>Seat Spring Tie Clip</p>			
	11-0209 secures spring together set of 3	47-72	\$1.95	
<p>8-0070</p> 	<p>Spring-seat track adjust</p>			
	11-0307-S one per side	47-55	\$11.95	
	<p>Screws-seat upper retaining</p>			
	11-207-US 3 x 10-24 screws	47-55	\$1.25	
<p>11-207-US</p>  <p>11-207-SF</p> 	<p>Seat Adjuster kit-replacement for rod style</p>			
	8-0070 Cable-seat adjust kit w/ adjustable turnbuckle	50-87	\$12.95	
 <p>11-207-PR</p>	<p>Seat-upper & lower</p>			
	11-207-PR	47-55	\$1499.00	0

Bill's Truck Shop

Phone (905) 725-3460 / (905) 725-2022 / Fax (905) 404-2302 email: bill@billstruckshop.com

Interior-Seats-hardware

Group 11

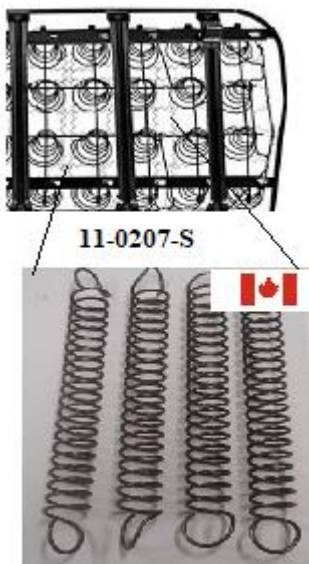
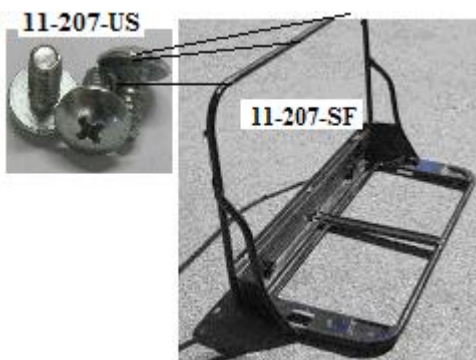

Screws-seat upper retaining

11-207-US 3 x 10-24 screws

Seat-upper

11-207-U

Seat-lower

11-207-L

Seat Skirts

11-207-47-S on outside of seat

11-207-50S on outside of seat

Seat Adjuster

11-207-47A has cables etc

11-207-50A has a side to side rod

Seat Frame

11-207-SF cable or rod adjustment style

Springs NEW

11-0207-S spring-seat base tension spring-set of 4
4 Secures the standing coil springs

Spring-Seat handle-lock return

11-207-HS one on each track

Seat Track---requires kit # 11-207-50HK

11-207-47T OE was cable adjust side to side

11-207-50T OE was rod adjust side to side—pair
use as replacement for all years

Nut kit-seat track

11-207-50HK cab base & seat base 12 pcs

Year

New

Used

47-55

\$1.25

47-55

\$50.00

47-55

\$250.00

47-50

\$30.00

50-55

\$30.00

47-50

\$15.00

51-55

\$15.00

47-49

50-55

Inquire

47-59

\$14.95

47-55

\$9.95

47-50

\$100.00

47-55

\$225.00 \$100.00

47-55

\$11.95

Bill's Truck Shop

Phone (905) 725-3460 / (905) 725-2022 / Fax (905) 404-2302 email: bill@billstruckshop.com

Interior

Due to the fluctuation of the Canadian and American dollars call for current prices

Group 11



11-211



11-212-FM



11-0HSD



11-213-53



11-213-R

11-0213-S



10782

Inquire about any other colours not listed

Carpet with Underlay- Cut to fit with edges sewn & heel pad- can be special ordered w/o seat frame (add F) and w/o gas tank in cab 49-55

Available in **cut pile or loop pile**

Can also be ordered w/o pedal holes

			<u>Year</u>	<u>New</u>	<u>Used</u>
11-210-G	loop pile w/ seat frame	grey	47-55	\$289.95	
11-210-BL	loop pile w/ seat frame	black	47-55	\$289.95	
11-210-BR	loop pile w/ seat frame	brown	47-55	\$289.95	

Other colours available on special order

11-210-BL-F-T	black w/o seat frame & tank in cab		47-55	\$289.95	
	grey w/o seat frame & tank in cab		47-55	\$289.95	

CARPET- 2 yards – call for other colours

8-000Y-01 black-loop pile approx 80 “ x 72” \$144.95

Rubber Floor Mat-black no holes are cut in mat-there are die-stamped markers where holes can be cut out –fits all models accept COE

11-211	auto & standard trans		47-55	\$209.95	
--------	-----------------------	--	-------	----------	--

Felt Mat

11-212-FM	felt underlay for rubber mat		47-55	\$44.95	
-----------	------------------------------	--	-------	---------	--

11-0HSD	Universal heat & sound insulation – 3/8 single sided foil backed w/ jute liner 4 x 6			\$47.95	
---------	--	--	--	---------	--

Inner Firewall Cover Pre-cut rubber and felt

11-213-53	firewall holes must be enlarged for plastic retainers		47-53	\$84.95	
11-213-54	firewall holes must be enlarged for plastic retainers		54-55	\$84.95	

Inner Firewall Cover Retainers

11-213-R	set of 8 plastic		47-53	\$10.95	
11-213-54R	set of 9 plastic		54-55	\$11.95	
11-0213-S	steel original type each		47-59	\$6.50	

10782	Dimmer switch grommet (included w/new carpet)			\$8.95	
-------	--	--	--	--------	--

Bill's Truck Shop

Phone (905) 725-3460 / (905) 725-2022 / Fax (905) 404-2302 email: bill@billstruckshop.com

Interior-Seat Belts

Group 11



When ordering seat belts there are many issues that will have to be addressed –eg-buckets-bench-height of seat-mount location etc / note- 3 point system lock buckle must be on side of person

Some applications may require an extender-see below for 6” metal ext or 12” belt extension

Belt Extension w/ hdw

		<u>Year</u>	<u>New</u>	<u>Used</u>
SB-12XBK	black		\$21.95	
SB-12XBL	navy blue		\$21.95	
SB-12XR	red		\$21.95	
SB-12XT	tan		\$21.95	
SB-12XG	gray		\$21.95	

Metal Extension

FAB-1008-1	1 “ 90 deg “ ext		\$9.95	
FAB-1001-3	8 “ ext w/3 holes @ 2 ½ apart- cut to desired length as required		\$11.95	

Seat Belts /lap style-w/ hdw.-per person

Push button STD (coloured) 22”long w/female end & 38” long w/ male end // or lift lever (chrome) type
DLX 22” long male end & 38” long female end- 60 “
DLX 42” long male end & 30” long female end-72”

SB-N2PB	black w/ std buckle		\$59.95	
SB-N2PR	red w/ std buckle		\$59.95	
SB-N2PG	grey w/ std buckle		\$59.95	
SB-N2PT	tan w/ std buckle		\$59.95	
SB-N2PN	navy blue w std buckle		\$59.95	
SB-N2PM	maroon w/ std buckle		\$59.95	
SB-N2LB	black w/chrome buckle		\$59.95	
SB-N2LB-72	black w/chrome buckle 72” long		\$59.95	
SB-N2LG	grey w/ chrome buckle		\$59.95	
SB-N2LN	navy blue w/chrome buckle		\$59.95	
SB-N2LN-72	blue w/chrome buckle 72” long		\$59.95	
SB-N2LR	red w/ chrome buckle		\$59.95	
SB-N2LTAN	tan w/ chrome buckle		\$809.95	

Bill's Truck Shop

Phone (905) 725-3460 / (905) 725-2022 / Fax (905) 404-2302 email: bill@billstruckshop.com

Interior-Seat Belts

Group 11

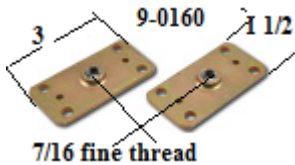
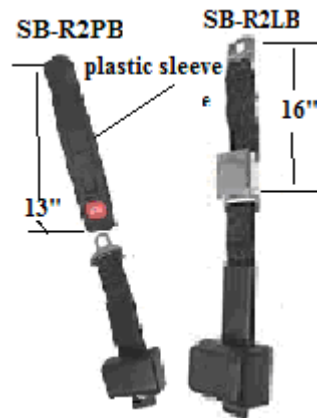

When ordering seat belts there are many issues that will have to be addressed –eg-buckets-bench-height of seat-mount location etc / note- 3 point system lock buckle must be on side of person

Some applications may require an extender-see below for 6” metal ext or 12” belt extension

2-point retractable w/ hdw-- 13 “ female w/ plastic sleeve-16” w/loose end

Push button STD or lift lever (chrome) type DLX

				Year	New	Used
SB-R2PB	black w/ std buckle	each			\$126.95	
SB-R2PR	red w/ std buckle	each			\$126.95	
SB-R2PG	grey w/ std buckle	each			\$126.95	
SB-R2PT	tan w/ std buckle	each			\$126.95	
SB-R2PM	maroon w/ std buckle	each			\$126.95	
SB-R2PN	blue w/ std buckle	each			\$126.95	
SB-R2LB	black w/ dlx	each			\$99.95	
SB-R2LR	red w/ dlx	each			\$99.95	
SB-R2LG	gray w/ dlx	each			\$99.95	
SB-R2LT	tan w/ dlx	each			\$99.95	

3-point retractable w/ hdw and chrome lift latch (air plane style) approx 24” inner female

SB-R3LB	black w/ chrome buckle	each			\$249.95	
SB-R3LDB	dark blue w/chrome buckle	each			\$234.95	

3-point retractable w/ hdw

Push button STD (coloured) or lift lever (chrome) type DLX approx 10” inner female

SB-R3PB	black w/ std buckle	each			\$209.95	
SB-R3PG	gray w/ std buckle	each			\$209.95	
SB-R3PM	maroon w/ std buckle	each			\$209.95	
SB-R3PT	tan w/ std buckle	each			\$209.95	

Anchor Plates

9-0160	w/ shoulder belt -7/16 fine thread / pr		47-66		\$29.95	
--------	---	--	-------	--	---------	--

Seat Belt Retractors-pr a reproduction of an OE option- for non retractable seat belts-prevents belt from falling out vehicle doors

9-0SBR		pair			\$34.95	
--------	--	------	--	--	---------	--

Bill's Truck Shop

Phone (905) 725-3460 / (905) 725-2022 / Fax (905) 404-2302 email: bill@billstruckshop.com

Door/Window Parts

Due to the fluctuation of the Canadian and American dollars call for current prices

Group 12



			<u>Year</u>	<u>New</u>
Inside Door Handle w / set screw				
12-01DH	chrome		47-66	\$24.95
Inside Window Handle w/ set screw				
12-01WH	chrome w/ black knob		47-66	\$24.95
NOTE -check for wear on shaft splines –handles must slide on without excessive play-set screw to seat in groove-not splines				
Inside Handle Gasket Set				
12-01HG	sponge seals & fibre washers-4 handles		47-66	\$6.95
Interior Handle Escutcheon				
12-01HE	off white	each	47-87	\$2.95
Inside Handle Set Screw for OE handles only-some applications used a 2nd lock set screw above				
12-0204	¼ x 20 hex head	each	47-66	\$0.60
12-0204-S	set screw 1/4-20x3/8		47-66	\$0.60
Outside Door Handles (with mounting gaskets)				
12-205	turns down handles	pair	47-51	\$99.95
12-205-PS	rear barn door panel/suburb-base is tapered to match door location-need core to rebuild		47-55	Rebuilt-Inquire
12-0107	pushbutton w/o right side button / lock	pr	52-59	\$94.95
Outside Door Lock With Key (2 keys) each				
12-205-1	in right door below handle also used on panel-suburban rear door includes 2 keys		47-51	\$79.95
12-205-3	one lock w/ 2 keys		52-55	\$69.95
12-205-4	with 2 matching locks & keys		52-55	\$129.95
12-205-47K	w-1 dr/1 ign/ 1 glove box lock & 2 keys		47-51	\$129.95
12-205-52-K	w-2dr/1 ign / 1 glove box lock & 2 keys		52-53	\$159.95
12-205-54-K	w-2dr/1 ign/1 glove box lock cyl-2 keys		54-55	\$159.95
Door Lock Gasket				
12-205-1G			42-51	\$1.95
Rear Door Handle & Lock Gasket				
12-205-LHG	panel-suburb rear door	2pcs	47-55	\$2.00
Door Lock Retainer				
12-205-1R	U-clip in door end to secure lock in door		47-51	\$12.95
Outside Handle Gasket Set				
12-205-5	moulded rubber w/ lock gasket		47-51	\$3.95
12-0205	w/o-ring for lock		52-66	\$3.75
Outside Handle Scratch Shields - chrome plated				
12-0185		pair	52-59	\$43.95

Bill's Truck Shop

Phone (905) 725-3460 / (905) 725-2022 / Fax (905) 404-2302 email: bill@billstruckshop.com

Door/Window Parts

Due to the fluctuation of the Canadian and American dollars call for current prices

Group 12



		<u>Year</u>	<u>New</u>	<u>Used</u>
Door Hinge Bolts (each) pickup truck				
12-0207-B	3/8 x 1 fine thread w/washer--each	47-55	\$1.50	
12-207-PB	panel/suburb rear barn door12 pc set	47-55		
Door Hinge Cage Nut new item				
12-0307-CN	3/8 fine thread rectangular nut each	55-59	\$11.95	
Door Hinges				
12-207-LU	left upper w/ check springs	47-55	\$125.95	\$45.00
12-207-RU	right upper w/check springs	47-55	\$125.95	\$45.00
12-207-LL	left lower	47-55	\$125.95	\$45.00
12-207-RL	right lower	47-55	\$125.95	\$45.00
Door Hinge Rebuilt Kit				
12-0HPK	2 (11/32) pins / 4 (13/32) OS brass bushing	47-91	\$12.95	
Door Hinge Springs				
12-207-2	on upper hinge-pair	47-55	\$10.95	
Lower Door Access Panels (each)OE has 1/4 hole for machine screw & 54-55 has hole for # 8 screw				
12-207-47L	left	47-55	\$69.95	\$25.00
12-207-47R	right	47-55	\$69.95	\$25.00
12-207-54L	OE has hole for # 8 screw left	54-55		\$45.00
12-207-54R	OE has hole for # 8 screw right	54-55		\$45.00
Lower Door Hinge Access Panel Screws -both sides				
12-207-4	1/4 machine screw -stainless steel 10 pcs	47-53	\$8.95	
12-207-5	OE doors have #8 screw 10 pcs	54-55	\$3.00	
Door Latch Spring				
12-208	on latch to prevent handle sag	47-51	\$9.95	
Door Latch Screw Kit				
12-208-2	2 doors 8 pcs	47-51	\$9.95	
12-0208-3	3pcs	52-59	\$2.50	
Door Latch Repair Clip Fits over worn tumbler				
12-0DLC	corrects a lot of door closing issues each	47-63	\$10.95	

Bill's Truck Shop

Phone (905) 725-3460 / (905) 725-2022 / Fax (905) 404-2302 email: bill@billstruckshop.com

Door/Window Parts

Due to the fluctuation of the Canadian and American dollars call for current prices

Group 12

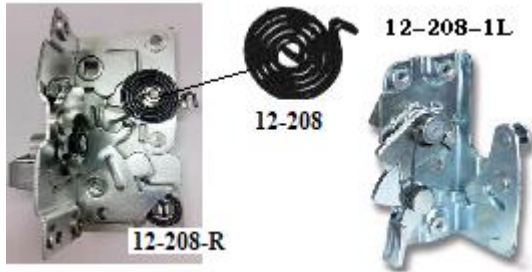

Door Latch-- Door Latch-----door latch & strikers CANNOT be used to adjust door fitment
 See next page on NEW style 47-51 and 51-55 door latch kits

			<u>Year</u>	<u>New</u>	<u>Used</u>
12-208-L	new improved	left	47-51	\$79.95	
12-208-R	new improved	right	47-51	\$79.95	
12-208-1L		left	52-55	\$69.95	
12-208-1R		right	52-55	\$69.95	

The easy latch kit is a vehicle specific bolt-on, bear jaw rotary claw latch kit. This kit features contoured jam plates to match the features of your vehicles doors. These are in no way a universal application. The bear jaw rotary claw latches are each designed to work with the exterior handles, interior handles, and the exterior door lock cylinders of the specified vehicles. Each piece of the bear jaw latches are zinc plated to fight corrosion. The internal claws are case hardened and black oxide coated. Each kit comes with everything you need for two doors. Latch plates, vehicle specific bear jaw rotary claw latches, templates, hardware, detailed instructions, striker plates, and even stainless steel striker bolts. The Easy Latch kit will have your doors opening and closing smoothly and safely. All of the kits are designed, manufactured, and assembled here in the US. Most of our Altman Easy Latch Kits jam plates are available in your choice of paint to match steel or mirror polished stainless steel.

47-51 doors do not have a OE lock on the drivers side-the Altman latch allows you to lock w/ inner door handle- a new lock must be installed on the left door if you want it to lock like the pass side-----handles NOT included

Easy Latch kit

12-2EL-47	uses OE w/ turn down handles		47-51	\$519.95	
12-2EL-47S	w/ shaved door handles		47-51	\$349.95	
12-2EL-52	w/ OE w/push button handles-pair		52-55	\$519.95	
12-2EL-52S	w/ shaved door handles		52-55	\$349.95	



Check our website www.billstruckshop.com for California trucks and parts

Bill's Truck Shop

Phone (905) 725-3460 / (905) 725-2022 / Fax (905) 404-2302 email: bill@billstruckshop.com

Door Rear-Panel-Suburban

Due to the fluctuation of the Canadian and American dollars call for current prices

Group 12

		Year	New	Used
		Panel-Suburban	Rear Door	hdw
Rear Door Striker w/barn doors				
	12-220-S	striker on left door	47-55	\$25.00
	12-220-SK	screws to secure striker- set of 4	47-55	\$3.00
Rear Door Latch w barn doors				
	12-223-U	upper latch		Inquire
	12-223-L	lower latch		Inquire
	12-233-SK	latch screw kit-per latch	47-55	\$2.75
Door Lock Retainer -Panel/Suburban				
	12-205-1R	U-clip in door end to secure lock in door	47-55	\$11.95 \$5.00
Door Lock Gasket				
	12-205-1G	pickup front right and 47-55 rear door on panel and suburban	42-55	\$1.95
Lock-rear barn door				
	12-205-1PS	use 12-205-1 panel-sub w/ barn doors	47-55	Inquire
Rear Door Link Arm Bumper-Panel/Suburban				
	1-0207-B	rear barn door upper check arm bumper-USA made	47-59	Inquire
Spring-rear door latch spring New # 12-0223-S				
	12-0223-S	use on up or lower	each 47-59	\$3.95
Rear Door Control Rod				
	12-224-R	rod 24" long up & lower	each 47-55	\$24.95
Rear Door Control Handle				
	12-225-H		47-55	\$50.00
Rear Door Control				
	12-225-C		47-55	\$50.00
Rear Door Control Cover				
	12-225-CC		47-55	\$10.00
	12-225-SK	screw kit	47-55	
Door Bumper includes hdw				
	12-228-B	left door lower-replacement	47-55	\$7.95
	12-205-PS	rear barn door panel/suburb-base is tapered to match door location-front turn down handle can be modified to replace rear door handle	47-55	\$39.95

Bill's Truck Shop

Phone (905) 725-3460 / (905) 725-2022 / Fax (905) 404-2302 email: bill@billstruckshop.com

Door-Window

Due to the fluctuation of the Canadian and American dollars call for current prices

Group 13

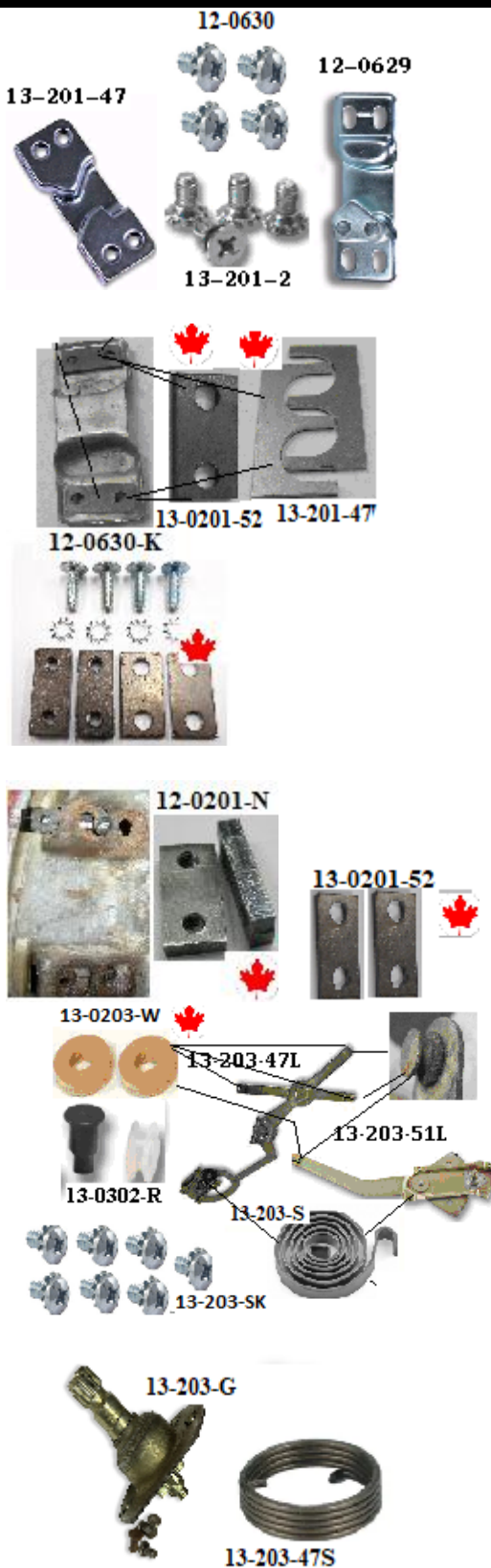

		<u>Year</u>	<u>New</u>	<u>Used</u>
Door Striker mounts on door jamb (each)				
13-201-47L	left-while stock lasts	47-51	\$14.95	
13-201-47R	right -while stock lasts	47-51	\$14.95	
13-201-47P	sold as pair only -	47-51	\$32.95	
12-0629-PR	sold as pair only	52-63	\$29.95	
12-0629-R	fits panel / suburban with rear barn doors	52-63	\$14.95	
Door Striker Screw Kit				
13-201-2	(¼ NC) (4) per side	47-51	\$3.00	
12-0630	screws w/ washers (4) per side	52-63	\$2.50	
Door Striker Nut Plate				
12-0201-N	threaded plate in backside of "B" pillar for striker screws (¼ NC) pr	47-57	\$12.95	
Door Striker Shims top & bottom for tsriker adjust				
13-201-47	0.064" thick pr	47-51	\$3.80	
13-0201-52	1/8 x 1 7/16 long x ¾ wide pr	52-63	\$5.95	
Door Striker Hdw kit				
12-0630-K	4 x ¼-20 NC Philips drive screws w/ washer,,shims & nut plates 1 side	52-early 57	\$19.95	
Window Regulator-new 47-55 regulators have the stud/roller combo(13-0302-R) NOT stud w/ leather washer				
13-203-47L	left	47-50	\$109.95	\$50.00
13-203-47R	right	47-50	\$109.95	\$50.00
13-203-51L	left	51-55	\$99.95	\$50.00
13-203-51R	right	51-55	\$99.95	\$50.00
Spring-window regulator assist				
13-203-S	left or right each	47-55		\$5.00
Window Regulator Screw kit				
13-203-SK	7 screws w/external tooth washer	47-51	\$4.00	
13-0203-SK	4 screws w/ external tooth washers	52-72	\$2.75	
Window Regulator Rollers-47-55 had a solid pin for the roller- w 2 leather washers on each stud- can be replaced w/ 55-63 type w/ nylon wheel				
13-0302-R	roller & pin	55-63	\$6.25	
Window Regulator Washer-leather washer on stud to guide & stop vibration- 1 per stud-applies to OE regulators only w/o nylon rollers-if your stud is worn-place in vice and turn ½ locates flat spot in different position				
13-0203-W	pair	36-55	\$2.95	
Window Regulator Gear Assembly w/ rivets				
13-203-G		47-50	\$59.95	
Spring-Window Regulator Gear-inside gear assembly				
13-203-47S	fits L or R	47-50	\$7.95	

Bill's Truck Shop

Phone (905) 725-3460 / (905) 725-2022 / Fax (905) 404-2302 email: bill@billstruckshop.com

Door-Window

Due to the fluctuation of the Canadian and American dollars call for current prices

Group 13



			<u>Year</u>	<u>New</u>	<u>Used</u>
Door Trim-OUTER					
13-206-L	painted	left	47-55	\$89.95	\$40.00
13-206-R	painted	right	47-55	\$89.95	\$40.00
13-206-SS	stainless steel	pair	47-55	\$329.95	Inquire
13-206-SSL	stainless steel	left	47-55		Inquire
13-206-SSR	stainless steel	right	47-55		Inquire
Outer Door Trim-screw kit--both sides					
13-206-SK	8 pcs		47-55	\$7.95	
Door Trim-INNER door glass trim inner dia is 11 /16 w/o vent window					
13-207-L	painted	left	47-50	\$144.95	\$60.00
13-207-R	painted	right	47-50	\$144.95	\$60.00
13-207-SS-L	stainless steel	left	47-50		\$75.00
13-207-SS-R	stainless steel	right	47-50		\$75.00
51-55 inner door glass trim is notched for vent handle striker & inner dia 15/16 "					
13-208-L	painted	left	51-55		\$40.00
13-208-R	painted	right	51-55		\$40.00
13-208-SS-L	stainless steel	left	51-55		\$75.00
13-208-SS-R	stainless steel	right	51-55		\$75.00
Door Glass Trim Screw set-inner					
13-207	16 pcs		47-55	\$5.95	
Door Glass Frame Screws (barrel nut & screw)					
13-0208	each	pair	47-63	\$1.25	
Door Glass Sash- steel support bottom of glass					
13-211-47L	left		47-50	NLA	\$40.00
13-211-47R	right		47-50	NLA	\$40.00
13-211-51 sash w/ roller guide 17 " long left or right -- each					
Can also be used when installing no vent window glass w/o frame---- caution- center glass on sash so roller does not extend past guide					
			51-55	\$61.95	
Door Glass Roller Guide-15" long					
13-211-47RG	screw to glass sash L or R	each	47-50		\$30.00
Door Glass Roller Guide -19" long used when installing once pc 47-50 glass in 51-55 w/ 51-55 window regulator----- also used on 47-50 original application- cut to fit/drill holes					
13-211-19	require mount holes to be drilled	each		\$44.95	
Guide Screw kit-roller guide to sash					
13-211-47SK	8 screws w external tooth washer	2 doors	47-50	\$6.95	

Bill's Truck Shop

Phone (905) 725-3460 / (905) 725-2022 / Fax (905) 404-2302 email: bill@billstruckshop.com

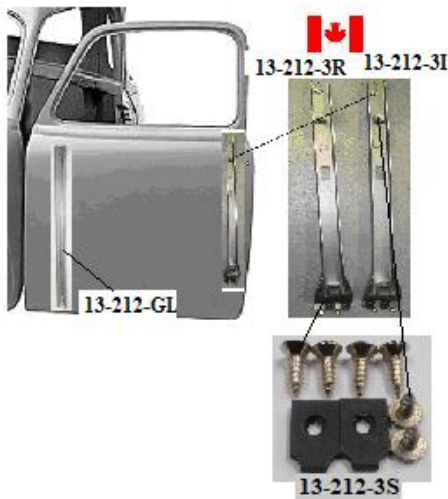

Door Glass Guide Channel-vertical guide below handle -47-50 w/ out vent window-51-55 w/ vent window

13-212-GL & GR 47-50 front L or R -use rears # 13-212-3L & 3R and requires adding support to door lower

				<u>Year</u>	<u>New</u>	<u>Used</u>
13-212-3L	rear	left	w/ hdw	47-50	\$37.95	
13-212-3R	rear	right	w/hdw	47-50	\$37.95	
13-212-4L	rear	left	w/hdw	51-55	\$29.95	
13-212-4R	rear	right	w/hdw	51-55	\$29.95	

Screws-Vertical Door Glass Channel @ door edge

13-212-3S	counter sunk/Philips drive	w/o vent window	10 pcs	both sides	47-50	\$4.25
13-212-4S	pan head/Philips drive-w	/vent window	6 pcs	both sides	51-55	\$1.95

Door Glass Inner Vertical Guide-at hinges

13-212-GL		left		47-50	Inquire	
13-212-GR		right		47-50	Inquire	

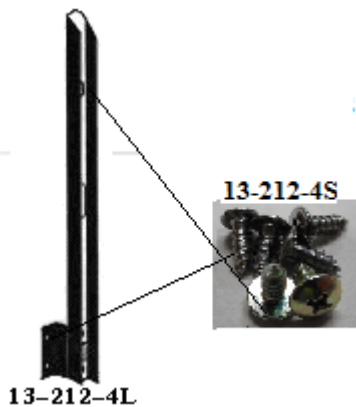

Door Control

13-205-L		left		47-55	\$44.95	
13-205-R		right		47-55	\$44.95	

Door Control Hdw kit -both sides

12-0205-K	6(zinc) screws	w/ tooth washer-Philips drive		47-72	\$2.95	
-----------	----------------	-------------------------------	--	-------	--------	--

Door Control Spring

13-205-1	fits L or R-correct sagging handles			47-55	\$14.95	\$5.00
----------	-------------------------------------	--	--	-------	---------	--------



Bill's Truck Shop

Phone (905) 725-3460 / (905) 725-2022 / Fax (905) 404-2302 email: bill@billstruckshop.com

Door-Window

Due to the fluctuation of the Canadian and American dollars call for current prices

Group 13

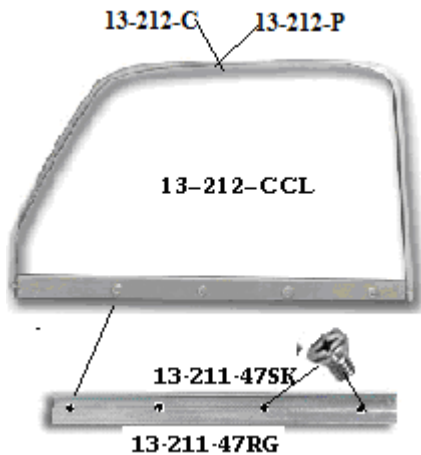

13-0PW-HS



13-251-PW



13-247-PW



Door Glass Frame Assembly --do not include roller guide

			<u>Year</u>	<u>New</u>	<u>Used</u>
13-212-CCL	chrome frame w/ clear glass	left	47-50	\$279.95	
13-212-CCR	chrome frame w/ clear glass	right	47-50	\$279.95	
13-212-CTL	chrome glass w/ tinted glass	left	47-50	Inquire	
13-212-CTR	chrome glass w/tinted glass	right	47-50	Inquire	
13-212-BCL	black frame w/ clear glass	left	47-50	\$259.95	
13-212-BCR	black frame w/ clear glass	right	47-50	\$259.95	
13-212-BTL	black frame w/ tint glass	left	47-50	Inquire	
13-212-BTR	black frame w/ tint glass	right	47-50	Inquire	

NOTE-requires 7 ft per frame of glass setting tape #1-0GST-1-----1/12 W x 0.047 thick

Door Glass Roller Guide-15" long

13-211-47RG	screw to glass sash L or R	each	47-50		\$30.00
-------------	----------------------------	------	-------	--	---------

Door Glass Roller Guide -19" long used when installing once pc 47-50 glass in 51-55 w/ 51-55 window regulator-----also used on 47-50 original application- cut to fit/drill holes

13-211-19	require mount holes to be drilled	each		\$44.95	
-----------	-----------------------------------	------	--	---------	--

Guide Screw kit-roller guide to sash

13-211-47SK	8 screws w external tooth washer	2 doors	47-50	\$1.95	
-------------	----------------------------------	---------	-------	--------	--

Door Glass Frame w/ o lower glass sash

13-212-C	chrome	L or R	each	47-50	\$50.00
13-212-P	painted	L or R	each	47-50	\$50.00

Power Windows- includes chrome switches, wiring harness, US made Sieman motors on original style window regulators w/ complete instructions- Brass iolite thrust bearings at pivots-----CALL FOR MORE INFO

13-247-PW	doors w/o vent windows w/ door switches		47-50	\$984.95	
13-251-PW	doors w/ vent windows w/door switches		51-55	\$984.95	

To switch to crank handle switches-add cost below

Crank Handle Switches

13-0PW-HS	check shaft length	pair	40-72	\$225.00	
-----------	--------------------	------	-------	----------	--

Bill's Truck Shop

Phone (905) 725-3460 / (905) 725-2022 / Fax (905) 404-2302 email: bill@billstruckshop.com

Door-Window

Due to the fluctuation of the Canadian and American dollars call for current prices

Group 13

13-214-LBT

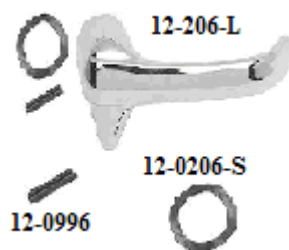
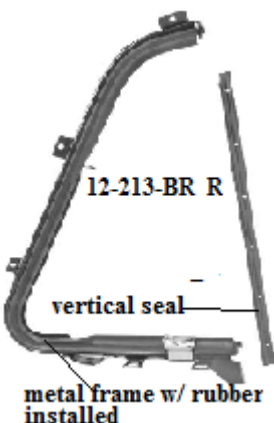

Inquire about used vent window

	<u>Year</u>	<u>New</u>
13-214-LB black post/chrome glass frame w/ clear glass-left	51-55	
NEW PRODUCT!!		
13-214-RB black post /chrome glass frame w-clear glass-right	51-55	\$569.95
13-214-LBT black post/chrome glass frame w/ tinted glass-left	51-55	\$569.95
13-214-RBT black post/chrome glass frame w/ tinted glass-right	51-55	Inquire
13-214-LCC stainless post/chrome vent frame w/ clear glass-left	51-55	Inquire
13-214-RCC stainless post/chrome vent frame w/ clear glass-right	51-55	\$579.95
13-214-LCT stainless post/chrome vent frame w/ tinted glass-left	51-55	\$579.95
13-214-RCT stainless post/chrome vent frame w/ tinted glass-right	51-55	\$579.95
Vent Window install hardware kit		
13-213-HK 9 pcs per side	51-55	\$5.95
Vent Handle Kit Chrome plated with pin and washer		
12-206-L left	51-55	\$19.95
12-206-R right	51-55	\$19.95

Vent Frame w/ weather stripping-outer frame only re-use vertical post---requires vent assembly kit #1-0VHK-64

13-213-BR-L left side	51-55	\$199.95
13-213-BR-R right side	51-55	\$199.95

Vent Window Frame Tension Spring

13-0213-S	each	51-91	\$11.95
-----------	------	-------	---------

Vent Handle Tension Spring/Washer

12-0206-S	each	51-72	\$0.60
-----------	------	-------	--------

Vent Handle Roll Pin

12-0996	each	51-72	\$0.30
---------	------	-------	--------

Bill's Truck Shop

Phone (905) 725-3460 / (905) 725-2022 / Fax (905) 404-2302 email: bill@billstruckshop.com

Fuel System

Due to the fluctuation of the Canadian and American dollars call for current prices

Group 14



Note - original fuel sender are 0- 30 ohm

Gas Tank kit 19 gallons-top right of centre fill-rear frame mount w/ hdw internal baffles ,zinc plated, silver painted-center front sender-side mount bkts middle of tank
-does not include fuel sender 47-53 \$125.00

		Year	New	Used
14-200-K	36" L x 14" W x 11" D	47-53	\$599.95	
14-200-54-K	36" L x 14" W x 11" D	54-55	\$599.95	

Gas Tank

14-201-B	47-48 under bed- 1/2-3/4 pickups and 47-55 panel/suburban 13.5 gal-----these fuel tanks will also fit in 1 ton and up trucks w/ the larger fuel tank(minor modification may be required)-use the 14-201-2 supports	47-55	\$649.95	
14-201-C	in cab	49-55	\$369.95	

Tank support w/ straps

14-201-3	in cab	49-55	\$119.95	
----------	--------	-------	----------	--

Gas Tank Insulator kit

14-0GTP	2" x 40 " pair	47-66	\$8.95	
---------	----------------	-------	--------	--

Gas Tank to Cab Bumpers -back of gas tank to cab

14-201-5	set of 3	49-55	\$7.95	
14-201-5E	each	49-55	\$2.75	

Gas Tank Drain Floor Seal

14-0305	tank drain/fuel line	49-59	\$4.95	
---------	----------------------	-------	--------	--

Gas Tank Bracket w/ straps kit

14-201-2	47-48 pickup & 47-55 panel /suburban	47-55	\$199.95	\$75.00
14-201-2S	straps only set for above pair	47-55	\$59.95	

Bill's Truck Shop

Phone (905) 725-3460 / (905) 725-2022 / Fax (905) 404-2302 email: bill@billstruckshop.com



14-201-5



14-202 14-202-1 14-0202-5



14-202-3 14-202-2 14-202-4



14-0212 14-0305 14-0425



6-0415-SC



14-0212-C

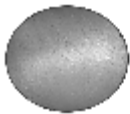

14-20GD



Gas Tank to Cab Bumpers –back of gas tank to cab

14-201-5	set of 3	49-55	\$5.50
14-201-5E	each	49-55	\$1.75

Gas Tank Drain Floor Seal

14-0305	tank drain/fuel line	49-59	\$2.25
---------	----------------------	-------	--------

Gas Tank Filler Neck Grommet

14-202-2	on bed side	47-48	\$18.95
14-202-3	on cab	49-55	\$9.95
14-202-4	panel/suburban	47-55	\$9.95

Gas Tank Filler Neck Pipe

14-202	correct curved 2 ¼ x11”pipe- pickup bed	47-48	\$36.95
14-202-PS	panel-suburban ½ ton	47-55	\$34.95
14-202-1	pickup truck w/ tank in cab kit -grommet, hoses w/ clamps & pipe	49-55	\$106.95

Gas Tank Filler & Vent Hose

14-0202-5	2 ¼ x 6 “ long 47-48 pickup and 47-55 panel/surburban -located in right bed side	47-55	\$20.95
14-0212	pair pickup	49-59	\$19.95

Gas Tank Filler Hose Clamp (4)

14-0212-C	correct OE style 4pcs	49-59	\$12.95
14-0212-S	crew type hose clamps 4 pcs	49-59	\$8.25
6-0415-SC	2 ½ screw type hose clamps-pr	47-48 & 47-55	\$5.95

Fuel Line Grommet (thru floor) OD 1” / I.D. 3/8”

14-0425	when using sender 14 -304 on 49-53 trucks	49-59	\$2.95
---------	---	-------	--------

Fuel Fill Delete Plate

14-20GD	weld in-when removing tank from cab	48-54	\$23.95
---------	-------------------------------------	-------	---------

Fuel System

Due to the fluctuation of the Canadian and American dollars call for current prices

Group 14

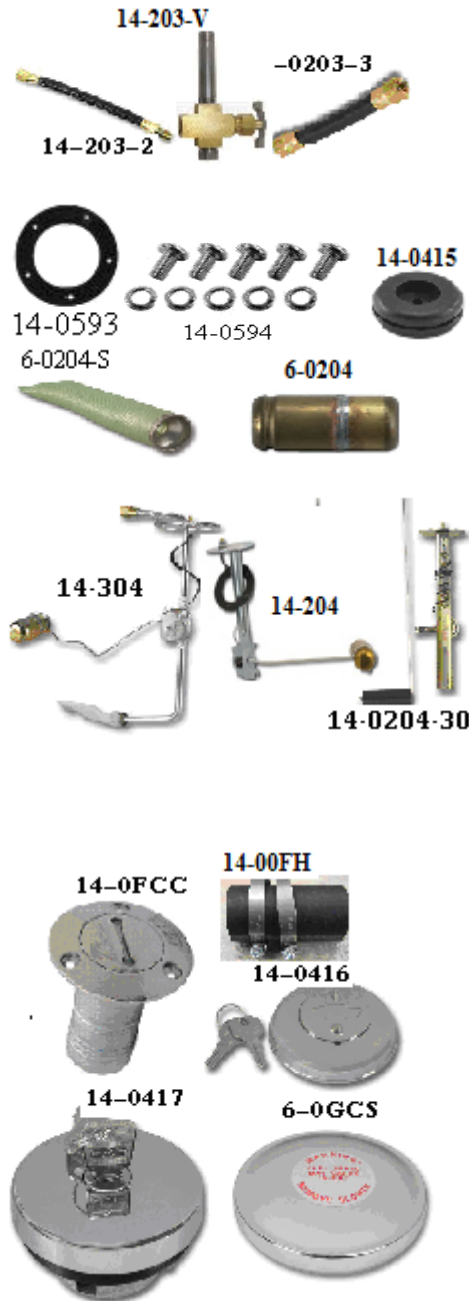

Flexible Fuel Line (under tank)

	Year	New	Used
14-203-2	49-53	\$28.95	
14-0203-3	54-59	\$29.95	

Fuel Shut-off Valve

14-203-V @ tank outlet pipe to hose	49--53	\$54.95	\$20.00
14-0310 2" pipe(1/8) w/ elbow w/ no valve used			

Gas Tank Sender Wire Grommet

14-0415 on floor	36-59	\$2.95	
------------------	-------	--------	--

Gas Tank Sender Unit

14-204 without fuel pickup w/ gasket -will also fit			
47-49 under bed tank gravity fed 30 ohm	47-55	\$59.95	
14-304 OE is 0- 30 ohm with fuel pickup	54-59	\$58.95	
14-0204-90 universal application-90 ohm	47-59	\$64.95	
14-0204-30 universal application-30 ohm	31-59	\$64.95	

Gas Tank Sender Unit Gasket

14-0593	47-66	\$2.50	
---------	-------	--------	--

Gas Tank Sender Screw Kit

14-0594 6 pcs	47-66	\$3.00	
---------------	-------	--------	--

Gas Tank Sender Float

6-0204 brass	47-72	\$11.95	
--------------	-------	---------	--

Fuel Sender Pickup Screen

6-0204-S OE metal type for 5/16 line	54-72	\$22.50	
--------------------------------------	-------	---------	--

Gas Cap – Original Type- vented

6-0GCS stainless steel NEW PRICE!!	47-70	\$14.95	
6-0GCP paint to match	47-70	\$27.00	

Locking Gas Cap---non vented

14-0416 w/ bowtie cover	47-70	\$55.95	
14-0417 chrome -smooth w/2 keys	47-70	\$22.95	

Cool Cap-flush mount, billet aluminum, screw cap w/ 1 1/2 fill neck, 3" flange NON venting

14-0FCC		\$99.95	
14-00FH fuel hose- neoprene 4" long x 1 1/2 ID w/ clamps		\$165.95	

Bill's Truck Shop

Phone (905) 725-3460 / (905) 725-2022 / Fax (905) 404-2302 email: bill@billstruckshop.com

Glass - Trim

Due to the fluctuation of the Canadian and American dollars call for current prices

Group 15



			<u>Year</u>	<u>New</u>	<u>Used</u>
<i>-Front glass is laminated / side and rear glass are tempered</i>					
Windshield (47-53) 2 piece / (54-55) 1 piece					
15-201-VTS	1 pc V-bent design-green tint w/shade top—windshield includes seal --will not accept stainless trim		47-53	\$599.95	
15-201-C	left or right / clear	each	47-53	\$99.95	
15-201-T	left or right / green tint	each	47-53	\$109.95	
15-202-C	clear		54-55	\$359.95	
15-202-T	tinted only		54-55	\$359.95	
15-202-TS	tinted w/ upper shaded band		54-55	\$359.95	
Door 15-202-T			Glass		
15-203-C	clear	each	47-50	\$53.95	
15-203-T	green tint	each	47-50	\$59.95	
15-203-G	smoked grey				
each			47-50	\$62.95	
15-204-C	clear	each	51-55	\$62.95	
15-204-T	green tint	each	51-55	\$64.95	
15-204-G	smoked gray	each	51-55	\$72.95	
15-203-T2	larger fit when installing as 1/pc glass w/o frame on glass in 51-55 trucks	tinted /each	47-55	\$75.00	
Door Glass w/ Sash					
15-204-CSL	left- clear		51-55	\$159.95	
15-204-CSR	right- clear		51-55	\$159.95	
Vent Glass					
15-205-C	clear	L & R each	51-55	\$49.95	
15-205-T	green tint	L & R each	51-55	\$51.95	
15-205-G	smoked grey	L & R each	51-55	\$49.95	
Uses 1-0GST-1 on vent glass install					

Bill's Truck Shop

Phone (905) 725-3460 / (905) 725-2022 / Fax (905) 404-2302 email: bill@billstruckshop.com

Glass - Trim

Due to the fluctuation of the Canadian and American dollars call for current prices

Group 15



-Front glass is laminated / side and rear glass are tempered

Rear Glass

		<u>Year</u>	<u>New</u>	<u>Used</u>
15-206-C	clear	47-55	\$84.95	\$30.00
15-206-T	tinted	47-55	\$89.95	\$30.00
15-206-G	smoked grey	47-55	\$89.95	

Corner Glass

15-207-CR	clear -R	47-55	\$79.95	\$30.00
15-207-CL	clear -L	47-55	\$79.95	\$30.00
15-207-TR	green tinted -R	47-55	\$79.95	\$30.00
15-207-TL	green tinted -L	47-55	\$79.95	\$30.00
15-207-SR	grey smoked glass-R	47-55	\$79.95	
15-207-SL	grey smoked glass- L	47-55	\$79.95	

Glass Setting Tape –rubber- for door and vent glass

1-0GST	0.062 thick-vent glass	per foot	\$2.00
1-0GST-1	thinner 0.047 thick	per foot	\$2.00

NOTE- 1955 trucks are 1st series like 47-54 and 2nd series that are like 1955-59

1947-53 have a 2 pc windshield and 1954-55 have a 1 pc windshield



15-208



15-210

Back Door Glass-Panel / Suburban

15-208-CL	clear -Left	47-55	\$74.95
15-208-CR	clear-Right	47-55	\$74.95
15-208-TL	green tinted--L	47-55	\$92.95
15-208-TR	green tinted – R	47-55	\$92.95

Back Hatch Glass-tempered Panel / Suburban

15-210-C	clear	47-55	\$495.00
15-210-T	tinted	47-55	\$499.00

Bill's Truck Shop

Phone (905) 725-3460 / (905) 725-2022 / Fax (905) 404-2302 email: bill@billstruckshop.com

Windshield

When installing glass into the sash-do not seat to bottom when urethaning in

Group 16

15-215-SS



15-216-P

15-216-47



15-216-S



15-216-R



15-220-R

15-220-47



15-220-54

15-220-S

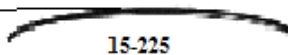

15-225

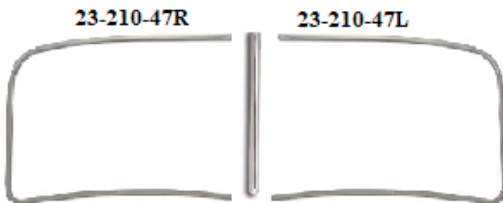

23-210-47R

23-210-47L

15-215-SS

Windshield Outer Center Moulding

15-215-SS stainless steel 47-53 \$79.95

Windshield Inner Post Trim

15-216-47 painted w/ correct 47-48 style covers 47-48 \$40.00

15-216-P painted w/ end retainers & hdw 47-53 \$39.95

Windshield Inner Trim Post Retainers

15-216-R painted pair 47-53 \$8.95

Windshield Inner Post Screw set

15-216-S please check that screws do not make contact w/ outer stainless mld 4pc 47-53 \$3.25

Windshield Inner Trim w/ defrost vent outlet

15-220-L w/ locating clips left 47-53 \$169.95

15-220-R w/ locating clips right 47-53 \$169.95

Windshield Inner Trim- locating clip

15-220-C set of 12 pcs 47-53 \$29.95

Windshield Inner Trim Screw Kit

15-220-47 stainless steel 20 pcs 47-53 \$9.95

15-220-54 stainless steel 6 pcs 54-55 \$2.50

Windshield Lower Moulding

15-225 at def vents on dash 54-55 \$200.00

15-220-54 lower trim screw kit (6) 54-55 \$2.00

15-220-S metal stands on mld each 54-55 \$10.00

Glass Setting Tape -rubber- for door and vent glass

1-0GST 0.062 thick-vent glass per foot \$2.00

1-0GST-1 thinner 0.047 thick per foot \$2.00

Windshield Moulding -outer

23-210-47 stainless steel pair 47-53 \$129.95

23-210-47L stainless steel left 47-53 \$69.95

23-210-47R stainless steel right 47-53 \$69.95

23-210-54 stainless steel 54-55 Inquire

Windshield Center Moulding-outer

15-215-SS stainless steel 47-53 \$49.95 \$15.00

Bill's Truck Shop

Phone (905) 725-3460 / (905) 725-2022 / Fax (905) 404-2302 email: bill@billstruckshop.com

Lighting

Due to the fluctuation of the Canadian and American dollars call for current prices

Group 16

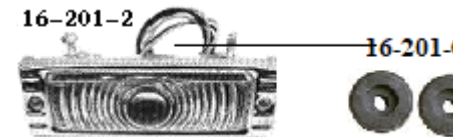
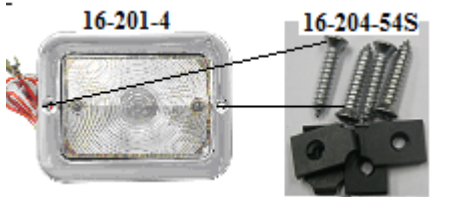
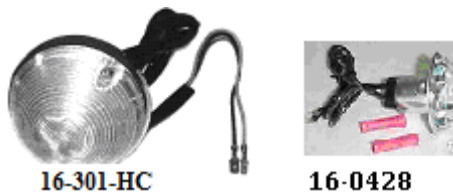
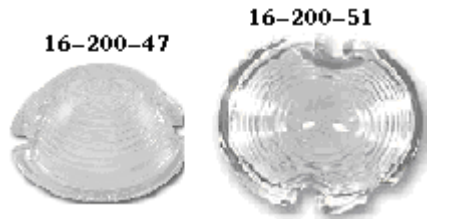

		<u>Year</u>	<u>New</u>	<u>Used</u>
Park lamp Lens (each)				
16-201-C	Chev-glass	47-53	\$11.95	
16-201-PA	Chev-GMC/amber	54-55	\$9.95	
16-201-PC	Chev-GMC/clear	54-55	\$9.95	
Park lamp Housing Assembly w/lens & wiring & 12 volt bulb				
16-201-2	w/ turn signals, clear lens	47-53	\$64.95	
16-201-2A	w turn signal amber lens	47-53	\$64.95	
16-201-2A-LED	LED w/ amber lens	47-53	\$129.95	
16-201-4B	Chev/GMC w/ out signals-clear lens	54-55	\$44.95	
16-201-4	Chev/GMC w/ turn signals-clear lens See 16-0428 for replacement socket	54-55	\$69.95	
For a quick inexpensive solution on 47-53 GMC park lights-use 55-57 park/signal light assemblies w/ either clear or amber lens				
16-301-HC	Chev/ with clear lens - each	55-57	\$49.95	
16-301-HA	Chev/ with amber lens - each	55-57	\$49.95	
16-201-GMC-47	housing- has smaller 2 3/ 8 lens	47-50		\$125.00
16-201-GMC-51	housing - has 2 3/ 4 lens	51-53		\$125.00
Park lamp Install kit				
16-204-54S	housing to fender w/ u-nuts 8 pcs	54-55	\$6.95	
Park lamp Harness Grommet				
16-201-G	in rear of housing /Chev only	pair 47-53	\$4.50	
Park lamp Bezel (each)				
16-204-C	Chev chrome	each 47-53	\$15.95	
Park lamp Lens Screw				
16-201-LS-54	4 pcs stainless screw	54-55	\$2.95	
16-204-1	Chev	pair 47-53	\$2.00	
Front Park lamp / Turn Signal Kit-to add signals to original park lamp assemblies add 16-205-D6 when staying w/ 6 volt system				
16-205-2	w/ 12 volt bulb	each 47-53	\$11.95	
16-205-3	w/ 12 volt bulb	each 54-55	\$10.95	

Bill's Truck Shop

Phone (905) 725-3460 / (905) 725-2022 / Fax (905) 404-2302 email: bill@billstruckshop.com

Lighting

Due to the fluctuation of the Canadian and American dollars call for current prices

Group 16



Park lamp Lens Gasket (pair)

		<u>Year</u>	<u>New</u>	<u>Used</u>
16-202	Chev	47-53		\$4.95
16-202-47	GMC-cork material	47-50		\$4.00
16-202-51	GMC-cork material	51-53		\$4.25
16-202-1	Chev-GMC	54-55		\$6.50

Park lamp Housing to Fender Gasket (pair)

16-203-47	GMC	47-50		\$9.95
16-203-51	GMC (rubber)	51-55		\$14.95
16-203-54	GMC-Chev	54-55		\$16.95

Socket-signal & brake

16-0428	2 wire for signal-brake & running light- accepts 2 pin off-set pin bulb	each		\$7.95
---------	---	------	--	--------

Original GMC park light were 1 wire for park alone NO SIGNALS we can update 2 wire using # 16-0428 and 6 or 12 volts bulbs

16-201-GMC-47	housing- has smaller 2 3/8 lens	47-50		\$75.00
16-201-GMC-51	housing - has 2 3/4 lens	51-53		\$75.00

Park lamp-LED 3 wire w/ park signal & ground

16-201-51LED	w/ clear lens-requires original housing & bezel to mount	51-53		\$64.95
--------------	--	-------	--	---------

Park lamp Bezel

16-204-47	GMC chrome	each	47-50		\$40.00
16-204-51	GMC chrome	each	51-53	DISC	\$40.00

Park lamp Lens

16-200-47	GMC glass w/ 2 3/8 lens	47-50		\$27.95	\$10.00
16-200-51	GMC glass w/ 2 11/16 lens	51-53		\$19.95	\$10.00

Bill's Truck Shop

Phone (905) 725-3460 / (905) 725-2022 / Fax (905) 404-2302 email: bill@billstruckshop.com

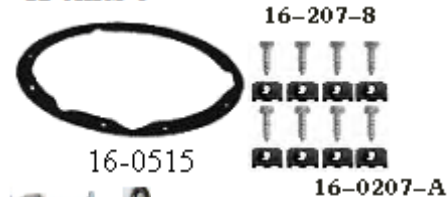
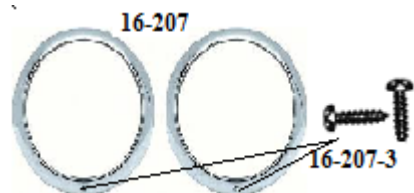
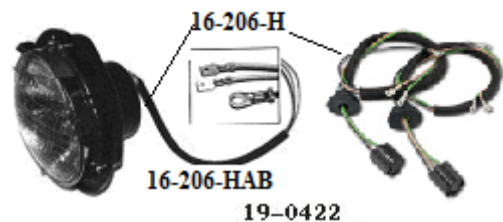

Headlamps---

it is safe to use a Halogen 6006 (H6006) as long its watts rating is roughly the same (~40-50) Max amp draw on high beam: 8.2 and on low beam: 6.2

		<u>Year</u>	<u>New</u>
16-0206-6V	6 volts		Inquire
16-0206-6VH	6 volt Halogen		\$34.95
16-0206-12	12 volt Halogen		\$22.95

Headlamp Assembly

16-206-HA	w/ universal harness w/out light	47-55	\$104.95
16-206-HAB	w/ OE style harness and 12 v bulb	47-55	\$183.95

Headlight Pot

19-0422	Chev & GMC	L & R	each	41-55	\$42.95
---------	------------	-------	------	-------	---------

Headlamp Harness w/grommets

16-206-H		pair		47-55	\$39.95
----------	--	------	--	-------	---------

Socket-headlamp harness repair

16-0001	3 wire	each			\$3.95
---------	--------	------	--	--	--------

Headlamp Rims stainless steel, w /screws, clips

16-207		pair		47-55	\$69.95
--------	--	------	--	-------	---------

Headlamp Rim Seals- wire core as original

16-0207-1				47-57	\$19.95
-----------	--	--	--	-------	---------

Headlamp Rim Seal Clips

16-207-2	4 pcs per light			47-55	\$4.95
----------	-----------------	--	--	-------	--------

Headlamp Rim Screws

16-207-3	stainless steel	pair		47-55	\$0.80
----------	-----------------	------	--	-------	--------

Headlamp Bulb Retainer Ring w/ screws

12-0HR-1		each		47-55 1 st and 62-72	\$18.95
----------	--	------	--	---------------------------------------	---------

Headlamp Bulb Retainer Ring Screws (6)

12-0HRS-6					\$2.95
-----------	--	--	--	--	--------

Headlamp Adjusting Screws and Nut

16-0207-A	1 screw w/ threaded nylon nut			47-57	\$4.95
-----------	-------------------------------	--	--	-------	--------

Headlamp Adjuster Spring

16-0207-S	w/ mount screw	each		47-59	\$4.95
-----------	----------------	------	--	-------	--------

Headlamp Bucket to Fender Gaskets

16-0515		pair		47-57	\$8.95
---------	--	------	--	-------	--------

Headlamp Bucket to Fender Screws and J-Nuts

16-207-8	one side	(16 pcs)		47-55	\$10.95
----------	----------	----------	--	-------	---------

Bill's Truck Shop

Phone (905) 725-3460 / (905) 725-2022 / Fax (905) 404-2302 email: bill@billstruckshop.com

Lighting

Due to the fluctuation of the Canadian and American dollars call for current prices

Group 17



Headlight Ring Support/Post

16-0208 secures to light pot lower w/ hdw each 47-57 \$6.25

Headlamp Bucket Wire Grommets

17-0721 pair 37-57 \$5.95

Headlight Wiring Inner Fender Grommet

17-0201 (OD-3/4-ID1/2) pair 47-early 56 \$3.95

Headlamp Terminal Block mounts on inner fender.

17-202-3 3- pin 47-53 \$19.95

17-202-4 4-pin 47-55 \$19.95

Taillamp Assembly with Wiring -w/ correct cloth wire & braided loom

----- Black w/ Chrome Bezel

17-203-LB black w/chrome bezel left 40-53 \$74.95

17-203-RB black w/chrome bezel right 40-53 \$74.95

17-203-2B black w/ stainless steel bezel 54-55 \$79.95

----- All Chrome

17-203-LC chrome housing left 40-53 \$94.95

17-203-RC chrome housing right 40-53 \$94.95

17-203-2SS stainless steel each 54-55 \$86.95

Taillamp Assembly w/ LED lightning

17-203-LED-L stainless steel housing left 40-53 \$124.95

17-203-LED-R stainless steel housing right 40-53 \$124.95

17-203-LED-LC stainless steel w/ clear lens-red -R 40-53 \$124.95

17-203-LED-RC stainless steel w/ clear lens-red -L 40-53 \$124.95

17-0303-LED-S **step side** stainless steel housing w/wiring -each 54-59 \$94.95

17-0303-LED -P **step side**-black housing w/ wiring each 54-59 \$89.95

Taillamp Lens (each)

-----Pickup

17-204-GWD glass w/ blue dot installed 40-53 \$21.00

17-204-P plastic 40-53 \$8.95

17-204-G glass 40-53 NLA \$10.00

17-204-1P plastic 54-55 \$5.95

License Light Lens-in left taillight

18-201 plastic -for left taillight 40-53 \$5.00

License Light Lens Gasket

18-201-G 40-53 \$1.95

Tail Lamp Lens-Panel or Suburban

17-0204-D oval red w/rear barn doors 47-56 \$21.95

17-204-G -round red w/ clam shell doors 47-56 \$24.75

Bill's Truck Shop

Phone (905) 725-3460 / (905) 725-2022 / Fax (905) 404-2302 email: bill@billstruckshop.com

Lighting

Due to the fluctuation of the Canadian and American dollars call for current prices

Group 17



		<u>Year</u>	<u>New</u>	<u>Used</u>
Taillamp Lens Gasket (pair)				
17-204-4	pickup	47-53	\$4.95	
17-0204-5	step side pickup	54-59	\$3.95	
17-0204-6	suburb / panel truck w/ barn door - oval lens	47-56	\$4.95	
17-0204-7	suburb /panel w/ clam shell doors-round lens	47-56		
Taillamp Bezel (each)				
17-205	chrome pickup	47-53	\$8.95	
17-205-1	chrome pickup	54-55	\$8.25	
17-0205-2	suburb / panel truck w/ barn door - oval lens	47-56	\$33.95	
17-0205-3	suburb /panel w/ clam shell doors-round lens	47-56		
Taillamp Wire Conduit / stainless steel				
17-0208	18 inches long	pair	\$19.95	
17-0208-12	12 inches long	pair	\$15.95	
Taillamp Wire Grommet				
17-0208-G	cut to fit	pair	47-72	\$2.75
Bluedot w/chrome bezel (pair)				
17-0209-P	Plastic	pair	47-72	\$8.00
Bulbs Signal or park. Single (S) or double (D) contact (each)				
Bulbs				
16-205-DS6	6 volt-1pin/ 3 candle power-short w/ matching lock pin - ft signal & rear-signal brake-3 candle power			\$1.65
16-205-DS6-21	6 volt-1pin/ 3 candle power-short w/ matching lock pin - ft signal & rear-signal brake - 21 candle power			\$1.10
16-205-DT6	6 volt-1pin/21 candle power-tall w/ matching lock pin- front signal &rear brake lights			\$3.95
16-205-D6	6 volt-2 pin- 3 candle power-tall w/ offset lock pins			\$2.95
19-0179	3 CP 12 volts-when signals added to ft lights			\$1.25
19-0179A	amber / 3 CP 12 volts when signals added to ft lights			\$2.25
19-0176	clear 12 volt - double contact w/ parallel lock pins 21 candle power			\$5.50
LED BULB				
19-0650	single contact w/ parallel pins 12 V upgrade on 47-53 taillight assembly			\$11.95
Dash Bulbs				
18-0DB-6v	6 v single contact/level pins			\$2.25
18-0DB-12v	12 v single contact/ level pins			\$1.50

Bill's Truck Shop

Phone (905) 725-3460 / (905) 725-2022 / Fax (905) 404-2302 email: bill@billstruckshop.com

Lighting

Group 18

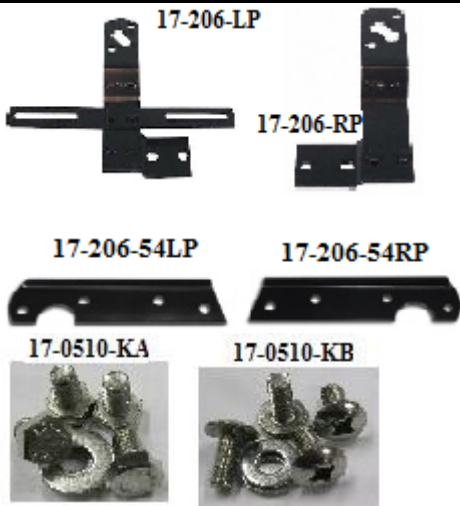

Taillamp Bracket 1947-53 Left w/ license bracket.

Painted

		<u>Year</u>	<u>New</u>	<u>Used</u>
17-206-LP	left	47-53	\$21.95	
17-206-RP	right	47-53	\$21.95	
17-206-LP- 1	1 ton up			Inquire
17-206-54LP	left	54-55	\$10.95	
17-206-54RP	right	54-55	\$10.95	

Chrome

17-206-LC	left	47-53	\$42.95	
17-206-RC	right	47-53	\$29.95	
17-206-1LC	left	54-55	\$13.95	
17-206-1RC	right	54-55	\$13.95	

Taillight Bkt Bolt kit

17-0510-KA	Philips drive w/ washer & nut stainless steel 12 pc kit	47-72	\$7.95	
17-0510-KB	7/16 hex head w/ washer 7 nut -stainless steel 12 pc kit	47-72	\$7.95	

NEW- taillight brackets- use when installing roll pan w/ plate light----uses 2 x **right side** lights (w/o plate light) installs on rear of stake pocket like OE -positions taillight closer to stake pocket and flush w/ tailgate---includes hdw-see picture below

17-207-P	paint to match	pair	47-53	\$32.95
17-207-S	brushed stainless	pair	47-53	\$44.95

Bill's Truck Shop

Phone (905) 725-3460 / (905) 725-2022 / Fax (905) 404-2302 email: bill@billstruckshop.com



Lighting

Group 18

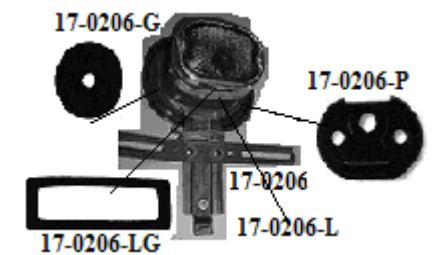
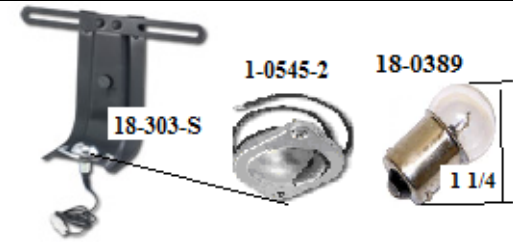

		<u>Year</u>	<u>New</u>	<u>Used</u>
License Plate Bracket & Lamp Assembly				
18-303-S	step side plate bkt ass.	54-59	\$59.95	
1-0545-2	replacement light assembly	54-72	\$13.50	
Taillamp Assembly w/ plate bracket -mounts on left rear door on panel, suburban w side by side doors				
18-0389	bulb-plate light-single contact-level pins 12V 6 CP each		\$1.95	
16-205-DS6	6 volt single contact 3 candle power	40-55	\$1.65	
17-0206		47-56		Inquire
Taillamp Assembly Mount Pad -between light housing and bracket				
17-0206-P	moulded rubber pad	47-56	\$69.95	
Taillamp Harness Grommet				
17-0206-G	in door behind housing	47-56	\$2.50	
License Light Lens				
17-0206-L		47-56	\$39.95	
License Lens Gasket				
17-0206-LG		47-56	\$1.55	
Taillamp Lens--pan/surb w/ gate				
17-0207-L	4 " plastic/round	34-55	\$24.95	
Taillamp Body Switch				
17-0207-S	door & body contact switch-pr	37-55	\$89.95	
Taillamp Assembly w/ plate bracket -mounts on lower gate on panel, suburban w/ upper hatch/lower gate-assembly folds when gate is open for plate viewing				
17-0207		47-55		\$200.00
Fender-signal & park light (red & amber lens)				
17-0567	roof & top of fender mount/big truck		\$26.95	
Roof Light ----usually found on larger series trucks				
17-0033	metal housing w/ plastic amber lens 12 V bulb and mounting hdw included		\$39.95	
Hood Light Kit				
	OE accessory kit		\$69.95	
Bullet Side Lights - original style brake-signal and running light on upper body on panel & suburban trucks-----OE accessory option				
17-210	black	each 47-55	\$174.95	
17-210-SS		47-55	\$239.95	

Bill's Truck Shop

Phone (905) 725-3460 / (905) 725-2022 / Fax (905) 404-2302 email: bill@billstruckshop.com



18-204-G



18-0203



18-0588



18-2481



18-0205-S

18-0205-OE

18-205-R



37-0315



18-0987

ATO spade fuses

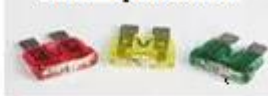

6 output connectors

18-0303



power supply in

Wiring Harness - A complete harness to replace the original includes signals PCV coated, colour coded, numbered ends w/ instruction. **Gen** harness for OE charging system & **Alt** for internal regulator alt style
Great for stock trucks

18-204-G	w/ generator	47-49	\$349.95
18-204-A	w/ alternator	47-49	\$349.95
18-204-1G	w/ generator	50-52	\$349.95
18-204-1A	w/ alternator	50-52	\$349.95
18-204-2G	w/ generator	53-55	\$349.95
18-204-2A	w/ alternator	53-55	\$349.95

Custom Classic Updated Wiring Harness kit- by American Autowire --for the customized truck

An excellent replacement updated wiring harness w/ blade type 18 fuse -21 circuit -includes plugs, switches for original or aftermarket gauges-HEI or point type dist harness- column connectors for stock or updated columns-front, rear & dome, under dash light harness-updates for original or AC updates, power windows, seats, stereo, electric fuel pumps etc-includes complete instructions, grommets, connectors, fuses, flasher extra wiring ties

18-2481		47-55	\$1224.95
---------	--	-------	-----------

Fusible Link

18-0588 9" 12 gauge slow burn wire- fuse wire is usually 4 gauges smaller then circuit wire w/ connectors-excellent safety precaution installed to ignition feed wire at starter approx. 20-25 amps---add to starter-ignition dash feed

\$4.99

Ignition Resistor

18-0203 reduces ignition from 12v to 9v

47-59 \$23.95

Wire Harness Clips

18-205-R	@ upper rad support to right headlight 4 required	47-55	\$3.95
18-0205-S	for sheet metal/bulk wire each	47-59	\$1.95
18-0205-OE	original style for sheet metal	47-59	\$3.79
18-0205-SM	main harness clip for sheet metal each	41-59	Inquire
18-0205-F	at frame locations each	47-59	\$1.50
37-0315	insulated clamp style w/ hdw pair		\$3.75

Fuse Holder-accessory

18-0987	sealed w/ hdw & fuse- note fuse size	\$4.95
---------	--------------------------------------	--------

Accessory fuse panel

18-0023	6 pin/uses ATO spade fuses	\$49.95
---------	----------------------------	---------

ATO Spade Fuses

18-0064	10 Amp ATO fuse-red	\$0.80
18-0066	20 Amp ATO fuse-yellow	\$0.80
18-0068	30 Amp ATO fuse-green	\$0.80

Bill's Truck Shop

Phone (905) 725-3460 / (905) 725-2022 / Fax (905) 404-2302 email: bill@billstruckshop.com



18-OWL-3

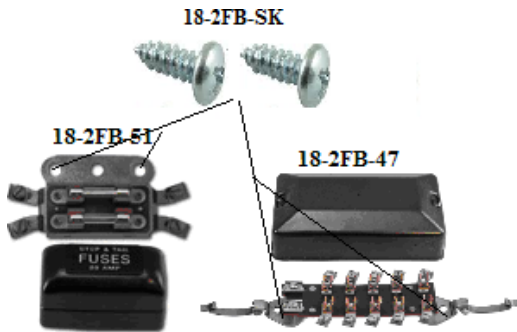

18-2FB-SK

18-2FB-51

18-2FB-47



18-0547



15-0HL

18-0018



14-042-H

14-242-S



18-0209-6

18-0135

Wiring Loom -seamless, black fabric ,heat resistant harness shield

18-OWL-1	1/4 in dia.	Per foot	\$1.95
18-OWL-3	3/8 in dia	Per foot	\$1.95
18-OWL-5	1/2 in dia	Per foot	\$1.95

Wiring Conduit –plastic,black,ribbed,split wiring covering

18-OWC-1	1/4 in dia	Per foot	\$0.60
18-OWC-3	3/8 in dia	Per foot	\$1.00
18-OWC-5	1/2 in dia	Per foot	\$1.10

Fuse Box – firewall mount w/ 2 or 5 fuse locations-complete OE used w/ Delco Remy logo

18-2FB-47	5 pin - H & L beam,park,tail,stop lights	47-50	\$75.00
18-2FB-51	2 pin tail , stop lights	51-55	\$50.00
18-2FB-SK	OE style mounting screws	pair 47-55	\$1.25

Wiring Plug w/ grommet @ connectors

18-0547	universal 8 plug pass through connector kit	\$22.95
---------	---	---------

Under Hood Lamp---early 1960 GM reproduction option

15-0HL	\$59.95
--------	---------

Horn Button-column mount

18-0018	6 or 12V application	\$9.50
---------	----------------------	--------

Horn

18-0210-6	6 volt inquire about original horns	47-59	\$60.00
14-042-H	12v high tone-replacement	47-87	\$21.95
14-042-L	12v low tone-replacement	47-87	\$21.95

Horn Support on intake manifold

14-242-S	applies to OE horn	37-52	\$27.95	\$15.00
----------	--------------------	-------	---------	---------

Horn Relay---most 6 volt horns draw up to 15Amps each

18-0209-6	6 volt only up 20 amp w/dual horn screw on terminals	41-56	\$44.95
18-0209	universal 6 or 12V w/ screw terminals Rated 14-18 amps @ 20 sec max	41-56	\$34.95
18-0135	universal 6 or 12 volt w/ push on terminal		\$24.95

Bill's Truck Shop

Phone (905) 725-3460 / (905) 725-2022 / Fax (905) 404-2302 email: bill@billstruckshop.com



Headlamp Switch

18-207-6	original style w/o fused dome& stop light circuit 6 volt w/ o rod-knob	47-55	\$88.95
18-207-6V	original style w/ fused dome& stop light circuit 6 volt w/o rod-knob	47-55	\$89.95
18-207-12	original style w/o fused dome& stop light circuit 12 volt w/ o rod-knob	47-55	\$89.95
18-207-12V	original style w/ fused dome& stop light circuit 12 volt w/ o rod-knob	47-55	NLA
18-207-12U	Headlight Switch-12V universal application w/rod & chrome knob screw on pins	47-59	\$27.95
18-0332	must be used when adding halogen lights to carry increased amp load -includes "D" shaped rod, aluminum knob and retainer	47-59	\$49.95

Headlight Switch Retainer Nut

18-207-R	stainless steel	47-55	\$18.95
----------	-----------------	-------	---------

Light Knob and Rod

5-203-47	stainless w/ maroon details	47-53	\$14.95
5-203-54	black w/ white center	54-55	\$12.50
5-204-54K	black knob only	54-55	\$5.95

Dimmer Switch w/ screws

18-208		24-55	\$18.95
--------	--	-------	---------

Dimmer switch -screw kit

18-0305	3 pcs	39-61	\$1.00
---------	-------	-------	--------

Turn signal Switch

18-211	correct eye terminals in column bowl	54-55	\$36.95
--------	--------------------------------------	-------	---------

Turn signal Housing Assembly w/ signal switch

18-0311-54H	Original cup style on column	54-56	\$199.95
-------------	------------------------------	-------	----------

Turn Signal Lever

5-305-1		54-59	\$12.95
---------	--	-------	---------

Turn signal Wedge w/ screw

18-0211-W		54-59	\$3.75
-----------	--	-------	--------

Turn signal Cancel Plate

18-0214		54-59	\$5.60
18-0214-HK	2 screws w/ washers	54-66	\$1.25

WIRING

Due to the fluctuation of the Canadian and American dollars call for current prices

Group 20



	<u>Year</u>	<u>New</u>	<u>Used</u>
Turn signal Switch Assembly w/ brake lights control- With wiring diagram. Universal - comes w/6 indicator volt bulb -- use 3 pin flasher make sure switch has good ground to column			
18-0551-U can be used on 6v or 12v	40-59	\$52.95	
Turn signal Flasher Plug and Harness w/Bkt			
18-213-P	47-59	\$44.95	
Turn signal Flasher			
18-0213-F6 6 volt 3 pin		\$26.95	
18-0213-F12-L 12 volt 3 pin-use w/ LED lights		\$18.95	
18-0213-F12-L2 12 volt 2 pin w/ ground wire use w/ LED lights		\$22.50	
18-0213-F12 12 volt 3 pin		\$24.95	
14-0SF-12 12 volt 2 pin		\$9.95	
14-0SF-12HD 12 volt HD electronic		\$14.95	
Upper Column Bearing w/ Horn wire			
18-0311	47-59	\$84.95	\$30.00
Dash Bulbs			
18-0HB-6v smaller 7/16 head for high beam indicator		\$2.15	
18-0DB-6v single contact/level pins		\$1.50	
18-0DB-12v single contact/ level pins		\$1.20	
Socket-Dash Bulb			
18-0DB-S USED OE metal socket w/ new harness	47-66	\$9.95	
18-0DB-SN new plastic replacement socket w/ ,6" wire	47-66	\$4.95	
Wiring-Dash Bulb --replaces dash bulb wiring when insulation is broken away using your original metal socket-reuse original steel socket			
18-0DB-W replacement terminal w/ 8" wiring for OE steel sockets		\$1.75	
Wiring-taillight/park w/ single pin			
18-0PB-W -bulb # 63, 67, 81, 89, 93, 209, 1003, 1073, 1129,1133,1141,1156		\$3.50	
Fuses-barrel style 1 ¼ long			
18-0003 3 amp		\$0.99	
18-0004 4 amp		\$0.99	
18-0005 5 amp		\$0.99	
18-0010 10 amp		\$0.99	
18-0015 15 amp		\$0.99	
18-0020 20 amp		\$0.99	
Ground Strap-tin coated copper wire			
18-0170-8 8" 11 gauge w/ 3/8 eyelets		\$12.95	

Bill's Truck Shop

Phone (905) 725-3460 / (905) 725-2022 / Fax (905) 404-2302 email: bill@billstruckshop.com

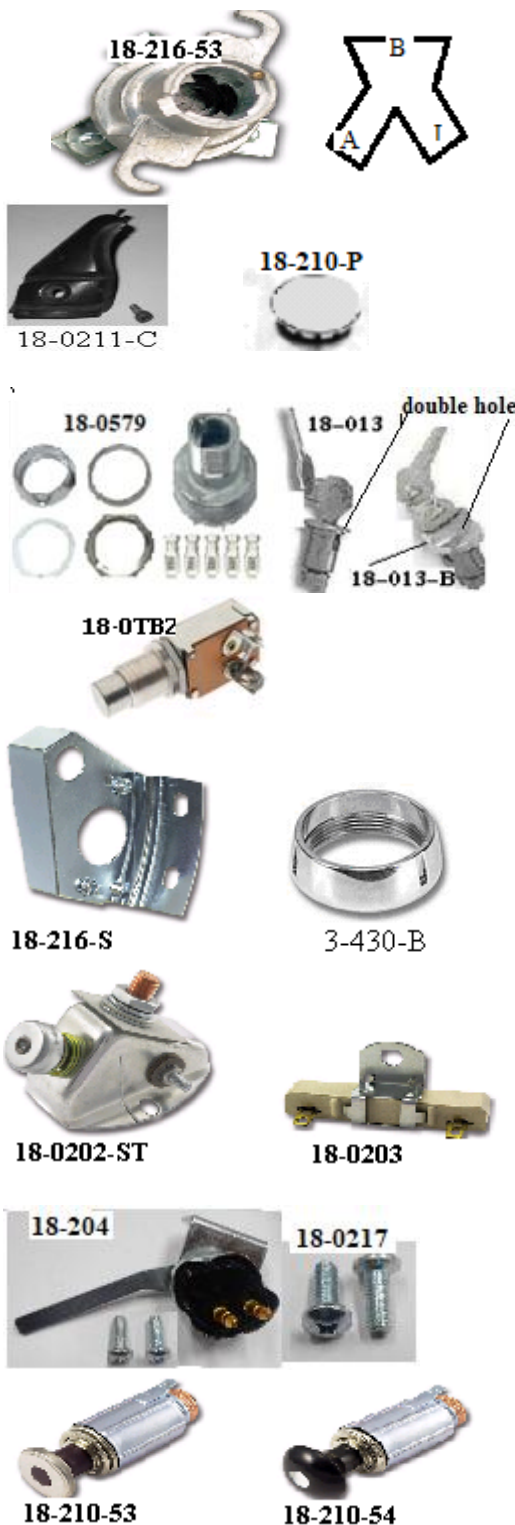

Horn Wire Cover @ lower column

18-0211-C 47-59 \$10.00

Cigarette Lighter Delete plug

18-210-P plug for lighter hole w/ lighter delete 47-53 \$2.00

Ignition Switch-universal type

18-0579 new replacement when key start (4 position) is required-direct fit into OE switch support w/ trim nut to secure-5 male spade terminals -uses key # 18-013 or 18-013-B 47-55 \$59.95

Ignition Switch-

18-216-53 original style w/ foot start- mounts in switch support 47-53 \$59.95

18-216-54 original style w / foot start-mounts in switch support 54-55 \$69.95

Ignition Switch Bezel—for 54-55 ignition switch

3-430-B a good replacement bezel from 64-66 chev truck 54-55 \$18.00

Ignition Cylinder w/OE Style Keys

18-013 (double removal hole) 47-66 \$21.95

18-013-B extension allows for vehicle to be started w/o keys if not placed in lock position-also need keys to place in lock position- w/ 2 keys (double removal hole) 47-66 \$16.95

Support-ignition switch

18-216-S bracket to mount OE style switch 47-53 \$28.95 \$10.00

Push Button Start Switch

18-0TB2 dash mount push button start switch-w/ aut trans or electric start solenoid 15A@12V 5/8 shaft dia \$19.95

Starter Switch -foot Start with side terminal

18-0202-ST with side terminal for 12V ignition 38-59 \$35.95

18-0202 w/ out side terminal w /6 volt 38-59 \$25.95

Ignition Resistor

18-0203 reduces ignition from 12v to 9v 47-59 \$11.90

Brake Light Switch

18-204 w/ screws 42-55 \$12.95

Brake Switch Screw kit

18-0217 pair 42-59 \$1.00

Cigarette Lighter Assembly w/o wire

18-210-53 w/ chrome knob 47-53 \$36.95

18-210-54 w/ black knob-white center 54-55 \$36.95

Bill's Truck Shop

Phone (905) 725-3460 / (905) 725-2022 / Fax (905) 404-2302 email: bill@billstruckshop.com

Mirrors

Due to the fluctuation of the Canadian and American dollars call for current prices

Group 20



Outside Mirror Arm

Year New

Painted

20-202-RP	right	47-55	\$34.95
20-202-LP	left	47-55	\$34.95

Chrome

20-203-RC	right	47-55	\$44.95
20-203-LC	left	47-55	\$44.95

Outside Mirror Arm Gasket w/ moulded lip

20-203-G		47-55	\$3.00
----------	--	-------	--------

Outside Mirror Arm Screw Set

20-203-S	Stainless Steel w/ hdw	pr	47-55	\$2.50
20-203-OE	collared style-Philips drive-steel	pr	47-55	\$5.00

Outside Mirror Head

When setting the mirror head for viewing loosen the 3 set screws on back of head & tighten when in desired location-this prevents scratching the pivot ball and future rusting-also lube w/ grease

20-0PM	round/ribbed/painted		47-70	\$1.95
20-0CM	round/ribbed/chrome		47-70	\$23.95
20-0PRM	rectangular/painted		47-70	\$24.95
20-0SRM	rectangular/stainless		47-70	\$27.95

Peep Mirror Chrome Plated.

Mirror bracket, clamps on top edge of door.

20-0PM-C	4 " w/ curved arm-chrome	L or R		\$34.95
9-0PM-S	4" w/straight arm-chrome	L or R		\$36.95

Inside Mirror Head - Day/Night Chrome

20-206-DN			47-53	\$79.95
20-0206-DN			54-59	\$69.95

Inside Mirror Head stainless steel

20-206	w/ correct 2 1/4 long post		47-53	\$52.95
20-0306		Stainless Steel	54-59	\$34.95

Inside Mirror Bracket

20-207-SS	stainless steel		47-53	\$10.95
20-207-54	chrome-w/screws		54-55	\$33.95

Big Truck Extension Mirror-black

20-0704	includes mount hdw			
---------	--------------------	--	--	--

Bill's Truck Shop

Phone (905) 725-3460 / (905) 725-2022 / Fax (905) 404-2302 email: bill@billstruckshop.com

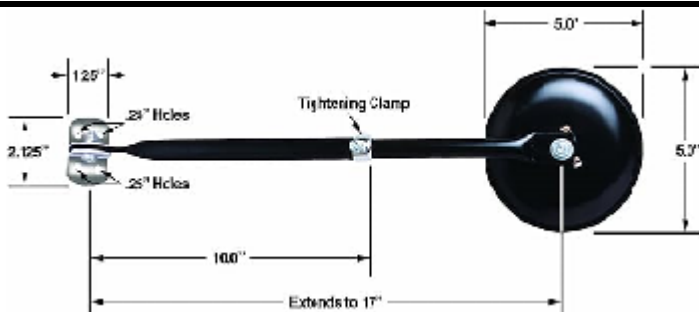

Wiper

Due to the fluctuation of the Canadian and American dollars call for current prices

Group 21



		<u>Year</u>	<u>New</u>	<u>Used</u>
Electric Wiper Motor requires removing original bushing & grommet & installing new nylon bushing in kit with switch, wiring and instructions -USA made				
21-201-1	CHEV/GMC 12 volt	47-53	\$449.95	
21-201-1-6V	CHEV/GMC 6 volt	47-53	\$349.95	
21-201-3	CHEV/GMC 12 volt	54-55	\$449.95	
21-201-3-6V	CHEV/GMC 6 volt	54-55	\$349.95	
21-0200	pulse wiper control 3 speed w/ washer—accepts 5-304-B bezel	47-72	\$139.95	
Bushing kit w/ new electric wiper motor				
21-0001	4 replacement nylon bushing w/ washers		\$7.95	
Wiper Switch—accepts 5-304-B trim bezel				
21-0201-S	universal 2 speed switch w/o washers	47-58	\$24.95	
Wiper Switch Bezel				
5-304-B	switch bezel when installing electric wipers		\$12.50	
Wiper Motor (Vacuum) good used-tested working				
21-202-3	has linkage driven control	47-53	Inquire	\$75.00
21-202-4	has cable driven control	54-55	Inquire	\$75.00
Wiper Motor Support -spot welded under dash				
21-202-47S	Chev & GMC	47-53		\$45.00
21-202-54S	54-55 Chev & 54 GMC	54-55		\$45.00
Wiper Arm Stainless Steel (each)				
21-203-L	original style left	47-53	\$19.95	
21-203-R	original style right	47-53	\$19.95	
21-203-1L	snap-in style left	47-53	\$23.95	
21-203-1R	snap-in style right	47-53	\$23.95	
21-0303-L	left	54-59	\$22.95	
21-0303-R	right	54-59	\$22.95	
Wiper Blade (each)				
21-204-8	original style 8 "	29-53	\$6.00	
21-204-9	original style 9 "	47-53	\$6.00	
21-204-10	original style 10"	47-53	\$6.00	
21-204-10N	snap-in style 10 "	47-53	\$20.95	
21-204-54	snap-in style 11"	54-55	\$19.95	
Wiper to Cowl Bezels - die-cast, chrome plated.				
21-205-53	pair	47-53	\$17.95	
21-205-54	pair	54-55	\$17.95	
Wiper Bezel Nuts				
21-0205-N	pair	47-59	\$8.95	
Wiper to Cowl Bezel Gaskets				
21-207-53	pair	47-53	\$3.75	
21-207-54	pair	54-55	\$3.75	

Bill's Truck Shop

Phone (905) 725-3460 / (905) 725-2022 / Fax (905) 404-2302 email: bill@billstruckshop.com

Wiper-Parts

Due to the fluctuation of the Canadian and American dollars call for current prices

Group 21



			<u>Year</u>	<u>New</u>	<u>Used</u>
Wiper Knob—will not fit new style electric switch					
5-204-47C	chrome		47-53	\$12.95	
5-204-47M	maroon		47-53	\$9.95	
5-204-54C	Chev	black	54-55	\$11.95	
5-204-54G	GMC	grey	54-55	\$7.75	
Wiper to Cowl Bezel Gaskets					
21-207-53		pair	47-53	\$3.75	
21-207-54		pair	54-55	\$3.75	
Wiper Control w/ retaining nut					
21-206-53			47-53		\$25.00
21-206-54			54-55		\$25.00
Wiper Control Retainer Nut					
21-206-53N	nut w/ washer to secure under dash		47-53		\$5.00
21-206-54N	original chrome		54-55		\$5.00
5-304-B	replacement stainless capped			\$12.50	
Wiper Control Gasket					
21-206-53G			47-54	\$0.99	
Vacuum Hose Firewall Grommet					
8-206	11/ 16 hole dia		47-55	\$1.95	
Vacuum Hose –vacuum wiper to engine outlet					
21-0206-VH	3' 7/32 dia hose		47-59	\$3.25	
Vac Outlet on Intake Manifold					
21-0206-F	brass 90 deg -----3/8 OD		47-59	\$8.95	\$5.00
21-0206-G	brass 90 deg----- 13/16 OD				\$8.00
21-0206-H	brass 90 deg---13/16 OD	2 pcs	47-59	\$14.50	
When adding a brake booster-requires 21-0936 & 21-0940 plus if using vac wipers 21-0921					
21-0940	brass reducer			\$6.95	
21-0936	brass elbow			\$7.95	
21-0921	nylon "T" fitting	3/8 x3/8 & 1/4		\$2.50	
Wiper Control Link Rod					
Between switch and wiper motor.					
21-208			47-53	\$6.50	
Wiper Control Link Grommets (pair)					
21-208-1			47-55	\$2.50	

Bill's Truck Shop

Phone (905) 725-3460 / (905) 725-2022 / Fax (905) 404-2302 email: bill@billstruckshop.com

Wiper-Parts

Due to the fluctuation of the Canadian and American dollars call for current prices

Group 21

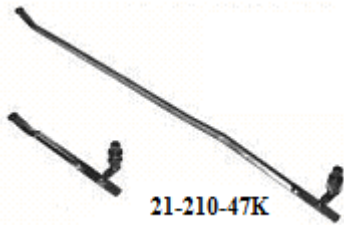

			<u>Year</u>	<u>New</u>	<u>Used</u>
Wiper Transmission Arm Grommets					
21-209		pair	47-53	\$3.50	
Wiper Transmission Arm Retainer					
Spring Retainer and Clips					
21-209-1			47-53	\$4.50	
21-0209-1			54-59	\$4.50	
Wiper Transmission Arm and Pivot					
21-210-47K		pair	47-53	\$229.95	\$125.00
21-210-47L	short arm	left	47-53	Inquire	\$80.00
21-210-47R	long arm	right	47-53	Inquire	\$80.00
21-210-54K		pair	54-55	\$229.95	
21-201-54L	both are the same length	left	54-55	Inquire	\$80.00
21-201-54R		right	54-55	Inquire	\$80.00

Bill's Truck Shop

Phone (905) 725-3460 / (905) 725-2022 / Fax (905) 404-2302 email: bill@billstruckshop.com



22-0206-A



22-205-6



22-205-12V



4-0211-ER



22-208

Heater Control Valve –requires original core-exchange
 22-204 REBUILT w/ Deluxe /Fresh Air Heater 47-55 \$169.00
 2 year warranty-must use antifreeze- max 4 lb rad cap—must have rebuildable core- w/ charged gas bulb must

Heater Control Seal kit

22-204-K w-springs, clips & instructions 47-55 \$56.95
 22-0204-S seal only 47-63 \$22.95

Heater Hose Water Shut-off Valve-manual

22-0206 5/8 hose to 3/8 pipe 37-62 \$49.95 \$10.00
 22-0206-A 5/8 in 5/8 out 37-62 \$34.95

Throttle Cable w/ Knob –use this cable to control water valve (22-0209) -set w/ cable “IN” water flow closed

5-208-8 stainless steel & maroon 47-53 \$27.95
 5-208-4 black w/ white “T” 54-55 \$26.95

Water Control Valve-control from inside the truck

22-0299 heater hose-manual control water valve -pull to open 5/8 by 5/8 hose dia- can use cable 5-208-8 or 54 5-208-4 w (T) cable to control setting 47-87 \$42.95

Heater Switch - Under dash Type Universal

22-205-6 w/ lighted control (black marking) 47-55 \$34.95
 22-205-12V w/ lighted control 10 amp/ 12 V 47-59 \$39.95
 22-205-OE original 6 volt switch 47-55 Inquire

Voltage Reducer-for radio & heater motor

4-0211-ER 1 ohm 50 watt metal encasement \$13.95

Heater Hose Grommets-in firewall

22-208 w/ Deluxe /Fresh Air Heater 47-55 \$8.95

Heater Hose

Accel
 18-0401 5/8 black-per foot \$2.00
 18-0402 3/4 black-per foot \$2.00

Bill's Truck Shop

Phone (905) 725-3460 / (905) 725-2022 / Fax (905) 404-2302 email: bill@billstruckshop.com

Heater-Parts

Due to the fluctuation of the Canadian and American dollars call for current prices

Group 22

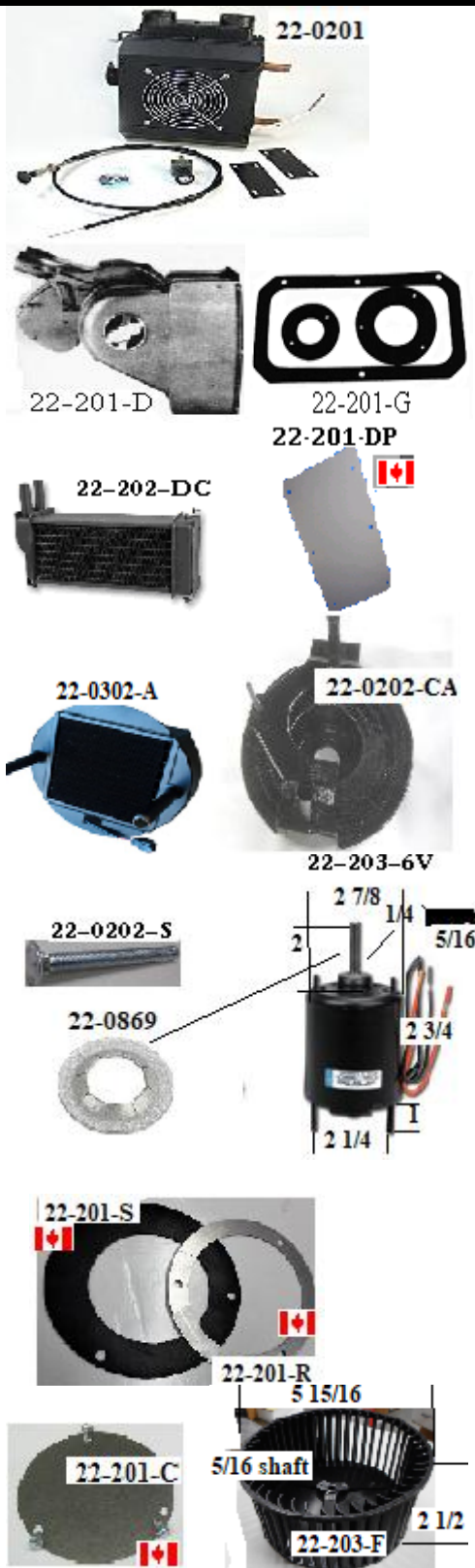

Heater Accessory Kit

22-0201 a compact 12 volt replacement-includes switch & cable operated defrost -does not include hose & vents 5/8 pipe outlets-2" defrost outlets -add-defrost hose #4-0051P & grommet # 22-208

Year New Used

22-201-D deluxe/fresh air w/ 8Lx 4 1/2 H x 3 1/2 W rectangular core

47-55 Inquire Inquire

22-202-S standard/ recirculating w/ 2 circular halves

47-59 Inquire Inquire

Heater Housing Mount Bolt-secures body to firewall

22-0202-S 1/4 x 2 "bolt w/ hdw

47-59 \$1.00

Heater Housing Cover Plate w/hdw 16GA galvanized

22-201-DP includes 6 1/4 x 1/2 Philips drive screws & washers

47-55 \$15.95

Deluxe Heater Gasket Set

22-201-G w/ Deluxe /Fresh Air Heater

47-55 \$17.95

Heater Core

22-202-DC - deluxe heater w/ 8Lx 4 1/2 H x 3 1/2 W w/end brackets- rectangular core also called Deluxe/ Fresh Air Heater ---does not fit 54-55 heater with recirculator option w/ the tall one inch wide vertical door.

47-53 \$399.95

Heater Core Assembly w /12v motor

22-0302-A replacement assembly w/ 12 V motor -new square core w/ round tanks- must install support from old assembly

47-57 \$449.95

Heater Core Assembly (copper) w/ 11/16 pipe outlets

22-0202-CA round assembly- no motor

47-57 \$389.95

Heater Motor-Standard or Deluxe

22-203-6V 6 volt w/ round recirculating heater 2 way rotation 1/4 shaft w/ 5/16 sleeve adaptor

47-55 \$99.50

22-0759-12V 12 V motor for round style heater cores w/ 1/4 inch dia shaft-2 5/16 stud -3.75 body length- 2 way rotation Recirculating Heater includes 5/16 shaft adapter sleeve

47-59 \$124.95

22-0203-HM12 12 V motor for rectangular heater w 5/16 shaft -mount bolt spacing 2 5/16-----4.20 " body length 2 wire for rev or forward rotation all w/ Deluxe/ Fresh air heaters

47-66 \$99.95

Heater Motor Fan

22-203-F plastic replacement

47-55 \$29.95

Retainer-fan-used to locate fan on shaft lower & secure upper

22-0414 1/4 ID used on 1/4 motor shaft pair

\$1.00

22-0869 5/16 ID used on 5/16 motor shaft pair

\$1.00

Heater Motor-Deluxe @ firewall

22-201-R ring w/ screws

47-55 \$12.95

22-201-S neoprene seal for ring

47-55 \$4.95

22-201-C cover w/ std heater

47-55 \$12.95

Bill's Truck Shop

Phone (905) 725-3460 / (905) 725-2022 / Fax (905) 404-2302 email: bill@billstruckshop.com

Heater Parts

Due to the fluctuation of the Canadian and American dollars call for current prices

Group 22



Heater Control Stands supports for dlx heater control rod w/grommet & def cable

22-216-S pair 47-55 \$32.95

Heater Control Rod Grommet

22-216-G in right temp control rod stand 47-55 \$1.95

Fresh Air Door Cable- controls the 1" vertical vent door from fresh air to recirculator - vertical door on heater box at kick panel -used on 1953 and 54-55 truck w/ correct looped end

22-216-53 stainless knob w/maroon center 53-53 NLA

5-208-8 Use throttle cable as replacement 47-53 \$27.95

22-216-54 black knob w/white center 54-55 \$44.95

Defroster Outlets

22-210 replacement are plastic each 47-53 \$33.00 \$20.00

22-210-4L left 54-55 \$30.00

22-210-4R right 54-55 \$30.00

Defroster Duct Hose-original cloth/wire type

22-209 1.75 x 54" 47-53 \$54.95

22-209-P plastic 1.75" 47-53 \$32.95

22-0209 2" x40" 54-63 \$54.95

22-0209-P plastic 2" 54-63 \$32.95

Manual Defroster Lever Decal

22-0212 fresh air & recirculating heater 47-59 \$5.95

Heater Mylar Decal -Chev/red & blue on silver-- GMC red on silver--decals used on 53-55 heaters

22-213-1 Chev- w/ fresh air heater 53-53 \$3.75

22-213-R Chev- w/fresh air & recirculating heater 53-53 \$3.95

22-213-G GMC- w/ fresh or recirculating heater 53-55 \$6.50

22-213-4F Chev - w/ fresh air heater 54-55 \$5.75

22-213-4R Chev - w/ recirculating heater 54-55 \$5.95

Heater ID Plate Aluminium, 3" round.-used on earlier 47-52 heaters

22-214-C Chev 3" red/blue on silver 47-52 \$39.95

22-214-G GMC 3" red/ silver 47-52 \$39.95

Bill's Truck Shop

Phone (905) 725-3460 / (905) 725-2022 / Fax (905) 404-2302 email: bill@billstruckshop.com

**22-215-M****Heater Knobs – Warmer-water flow control knob**

22-215-M	maroon w/ white letters	47-53	NLA
22-215-B	black	54-55	NLA
22-216-53	stainless knob w/maroon center	53-53	\$49.95
22-216-54	black knob w/white center	54-55	\$49.95

Bill's Truck Shop**Phone (905) 725-3460 / (905) 725-2022 / Fax (905) 404-2302 email: bill@billstruckshop.com**

Emblems-Trim

Due to the fluctuation of the Canadian and American dollars call for current prices

Group 23



23-208-G



23-0727



23-205-GMC



23-202-G



23-202-G1

BTS exclusive
made in USA



23-206-G



23-205-3



23-205-4



23-205-GMC

GMC_GMC-GMC-GMC-GMC

Year

New

Used

Front Grille Emblem

23-208-G

47-55

Inquire

Inquire

Hood Side Emblem -Chrome w/hardware

23-202-G GMC white w/red details pair

47-54

\$139.95

23-202-CG GMC chrome w/red details pair

47-54

\$179.95

CANADA built truck emblems

23-202-G1 100 GMC hood side emblem each

47-55

\$44.95

23-202-G9 930 GMC hood side emblem

47-55

Inquire

Accessory Hood Ornament

23-205-GMC chrome (special order)

47-55

\$649.95

Emblem Fastener kit

23-0727 8 x 10-24x1 studs & 8 high dome nuts 16 ;pcs

47-59

\$11.95

Hood Center Strip-mld may require adjusting to the hood contour before installing

23-206-G GMC stainless steel

47-54

\$99.95

Accessory Hood Ornament

23-205-3 chrome

47-53

\$199.95

23-205-4 Eagle/chrome - Chev

54-55

\$375.95

23-205-GMC chrome (special order)

47-55

Inquire

Bill's Truck Shop

Phone (905) 725-3460 / (905) 725-2022 / Fax (905) 404-2302 email: bill@billstruckshop.com

Emblems-Trim

Due to the fluctuation of the Canadian and American dollars call for current prices

Group 23



23-203-R/B



23-204-R



23-0727



23-206-C



23-0344



23-0345

CHEV_CHEV-CHEV-CHEV		Year	New	Used
Front Hood Emblem				
With mounting hardware. Both fit all years.				
23-201-SS	Chev - stainless steel	50-53	\$119.95	
23-201-CR	Chev - chrome	47-49	\$124.95	
23-201-5	Chev - stainless steel NEW !!	54-55	\$329.95	
Hood Side Emblem -Chrome w/hardware				
3100 are US model and 1300 are Canadian model				
23-202	CHEVROLET TRIFTMASTER pair	47-49	\$64.95	
23-202-1	CHEVROLET pair	49-53	\$74.95	
23-202-2	3100 pair	49-52	\$64.95	
23-202-2/36	3600 USA each	47-51	\$89.95	
23-202-2/38	3800 USA each	47-51	\$89.95	
23-202-3	3100 pair	53-54	\$55.95	
23-202-3/36	3600 USA each	53-54	Inquire	
23-202-4	3100 / CHEVROLET-1 st series pair	55-55	\$159.95	
23-202-5	1300 Canada model each	47-55	\$34.95	
23-202-6	1500 Canada model each	47-55		
Front Hood Emblem Mounting Gasket-Chev				
23-202-47		47-53	\$6.95	
23-202-54		54-55	\$6.25	
Front Hood Emblem Decals-Chev				
23-203-RB	red and blue decals	47-53	\$12.95	
Grill and Hood Emblem Decals-Chev				
23-204-RB	red stripes w/ black letters	54-55	\$14.95	
23-204-RW	red stripes w/ white letters	54-55	\$14.95	
23-204-WB	white stripes w/ black letters	54-55	\$14.95	
23-204-WW	white stripes w white letter	54-55	\$14.95	
Emblem Fastener kit- for threaded studs type only				
23-0727	8 x 10-24x1 studs & 8 high dome nuts 16 :pcs	47-59	\$12.95	
Hood Center Strip- mld may require adjusting to the hood contour before installing				
23-206-C	Chev stainless steel	47-54	\$149.95	
23-206-SC	Chev steel	47-54	\$179.95	\$100.00
23-206-SC-5	Chev/steel -large truck-57" long	47-54		\$75.00
NAPCO				
23-0344	Body emblem each	51-59	\$114.95	
23-0345	shift pattern plate	54.59	\$39.95	

Bill's Truck Shop

Phone (905) 725-3460 / (905) 725-2022 / Fax (905) 404-2302 email: bill@billstruckshop.com

Trim

Due to the fluctuation of the Canadian and American dollars call for current prices

Group 23

Front Fender Trim reproduction of the OE front fender upper stainless trim option that was available for panels & suburban's-can also be installed on pickups-inquire

23-216-FF pair w/ hdw 47-55 Inquire

Fender Trim reproduction of the OE front & rear fender stainless trim option that was available for panels & suburban's-can also be installed on pickups

23-216-F 12 pcs w/ hdw 47-55 Inquire

Bill's Truck Shop

Phone (905) 725-3460 / (905) 725-2022 / Fax (905) 404-2302 email: bill@billstruckshop.com



23-216-FF



Grills

Due to the fluctuation of the Canadian and American dollars call for current prices

Group 24

24-201-CR



24-202-CG



24-201-S

24-201-C

24-202-C



24-201-MK

24-201-HK



24-201-2

large truck-cab chassis-grille stands taller w/ more space between bars

pickup



wider bars

Chevy Grill 1/2- 3/4 and 1 ton

24-201-P	painted	47-53	\$749.95	Inquire
24-201-CR	chrome w/ cream back bars	47-53	\$999.95	
			\$\999.9	
24-201-BR	chrome grille w/ black bars	47-53	5	
24-201-CC	all chrome including back bars and supports	47-53	\$1159.9	5
24-201-LB	painting bars for 1 1/2 ton up (w 20" wheels) set of 5 painted as OE-reuse your original back bars etc	47-53	Inquire	NLA
24-202-PG	cream colour w/ black painted details	54-55		Inquire
24-202-CG	chrome	54-55	\$1999.95	Inquire

Grille Parts

Chev-Inquire about individual parts for this grille-supports, bars etc	47-53			
GMC -Inquire about individual parts for this grille-supports, bars etc	54-55		Inquire	Inquire
	47-53		Inquire	Inquire

Grill Hardware Assembly & install Kit

24-201-HK	Chev	47-53	\$32.95	
-----------	------	-------	---------	--

Grill Install kit

24-201-MK	Chev	bolts w/ j-nuts	47-53	\$11.95
24-202-MK	Chev	bolts w/ j-nuts	54-55	\$35.95

Lower Valance Hdw kit

24-201-2	j-nuts w/ screws 36 pcs-Chev	47-53	\$20.95	
----------	------------------------------	-------	---------	--

Grill Nose

24-202-C	Chrome Plated	54-55	\$149.95	
24-202-S	Steel	54-55	\$120.00	

Grille Extension & park light support

24-202-LE		54-55		\$75.00
24-202-RE		54-55		\$75.00

Inquire about individual grille parts

Bill's Truck Shop

Phone (905) 725-3460 / (905) 725-2022 / Fax (905) 404-2302 email: bill@billstruckshop.com

24-203-CS



24-203-CR



24-203-54-C

24-203-LE



GMC

GMC Grill

24-203-47-P	paint	47-48		Inquire
24-203-47-C	chrome	47-48		Inquire
24-203-P	paint	49-53		Inquire
24-203-CR	chrome w/ white back supports	49-53	\$1300.00	Inquire

Grill Surround- GMC

24-203-CS	chrome	47-53	\$699.95	
24-203-PS	paint	47-53	\$599.95	
24-203-54-C	chrome	54-55		
24-203-54-P	paint	54-55		

Grill Surround Extensions & park light support

24-203-LE		54-55		Inquire
24-203-RE		54-55		Inquire

Inquire about individual grille parts

1947-early 1948 GMC trucks had the CAR style bumper w/ the heavier forward mounted GMC grille-included support bars through the inner fender to frame for extra grille support-frame was approx 8" longer at front to support the grille which bolted directly to the frame -bumper bks are completely different

Bill's Truck Shop

Phone (905) 725-3460 / (905) 725-2022 / Fax (905) 404-2302 email: bill@billstruckshop.com

Hubcaps

Due to the fluctuation of the Canadian and American dollars call for current prices

Group 24



24-205-4SB



24-0205-S



24-206-S-R



24-205-SR



24-007-15S



24-007-15R



24-0201-15

Hubcap	Year	New	Used
Smooth- Baby Moon style			
24-0205-S stainless steel/smooth---w/ clip styles wheels only	each		\$79.95
24-0205-8 chrome/smooth ---fit outside ear wheels only	10 1/8 OD chrome		\$36.95
Chevy			
24-205-SR ½ ton stainless steel w/ red details-each	47-53	\$84.95	
24-205-2SR ¾ to 1 ton- chrome w/red details fit 15 to 17 “ split wheels –can be used on any clip wheels need to check dept of floating rear axle	each	46-53	\$99.95
24-205-4SB stainless steel w/ blue details -each	54-55	\$79.95	
GMC Note can also use on 54/55			
24-206-S-R stainless steel w/ painted red details- each	46-53	\$99.95	
24-206-S-W stainless steel w/ painted white details-each	46-53	\$79.95	
24-206-2S-R stainless steel w/ painted red details-each ¾ to 1 ton w OE split wheels	46-53	Inquire	
Beauty Ring (stainless steel)			
24-007-15S 15 inch w/ smooth face	each	47-72	\$39.95
24-007-15R 15-inch w/ ribbed face	each	47-72	\$39.95
24-007-16S 16 inch w/ smooth face	each	47-72	\$39.95
24-007-16R 16 inch w/ ribbed face	each	47-72	\$39.95
Moon Hub Caps—Salt Flat style			
24-0201-15 15 “ wheels brushed stainless steel	each		\$27.95

Bill's Truck Shop

Phone (905) 725-3460 / (905) 725-2022 / Fax (905) 404-2302 email: bill@billstruckshop.com

Wheels

Due to the fluctuation of the Canadian and American dollars call for current prices

Group 24



Wheel Clips –includes hdw

Clips for retaining original type hubcaps. (Each)

24-0905-15 ½ ton 15-16 “ 6 stud wheels

24-0905-15K ½ ton 15-16” 6 stud set of 5 w/hdw

24-0905-17 15-16- 17 “ 8 stud wheels

Rims Original Style used southern clip wheels

15 -16 “ wheels 4 – 4 ½-5 – 5 ½ -6 width

	<u>Year</u>	<u>New</u>	<u>Used</u>
24-0905-15 ½ ton 15-16 “ 6 stud wheels	37-62	\$4.50	
24-0905-15K ½ ton 15-16” 6 stud set of 5 w/hdw	37-62	\$19.95	
24-0905-17 15-16- 17 “ 8 stud wheels	47-62		\$5.00
15 -16 “ wheels 4 – 4 ½-5 – 5 ½ -6 width	47-62		\$75.00



Diameter

Rim diameter is measured from tire bead seat area to tire bead seat area



Width

Rim width is measured from tire bead seat area to tire bead seat area

Bill's Truck Shop

Phone (905) 725-3460 / (905) 725-2022 / Fax (905) 404-2302 email: bill@billstruckshop.com

Bumpers and Brackets

Group 24

24-216-R



24-216-F



24-0586



Bumper Bracket Kit w/ hardware

24-216-F	front 47-55 Chev and 49-55 GMC	47-55	\$189.95	\$80.00
24-216-R	rear 1/2 ton	47-55	\$159.95	

3/4 ton & up have a lower "step" in the brackets for the deeper 4" frame see below

24-216-R1	rear 3/4 ton	47-55	\$299.95	
24-216-PS	panel/ suburban rear bkt set	47-55		Inquire

Bolt-bumper bkt to frame

24-0586	1/2 x 2 w/ lock-flat washer & nut	each	\$2.00	
---------	-----------------------------------	------	--------	--

Spare Tire Mounts

24-2SM	Side Mount - Original for indented fender	47-55		Inquire
24-2UBM	under bed mount	47-55		Inquire
24-2TH	hook w/ nut to support load bar	37-55	\$14.95	

Bill's Truck Shop

Phone (905) 725-3460 / (905) 725-2022 / Fax (905) 404-2302 email: bill@billstruckshop.com



Bumpers and Brackets

Group 24

24-214-FC



24-214-4RC

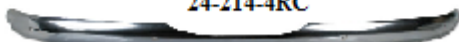

1-0BBS



1-0BBC



24-217



35-206-FRP



35-206-FRP

Bumpers –Premium Quality – triple nickel plated, and then chrome to a mirror finish

Front bumpers fit 47-55 Chev & 49 55 GMC also fit **Rear of Panel/Suburban-----see GMC grille section for info**

(F) Front, (R) Rear, (C) Chrome (P) Painted

(S) smooth GMC front bumper are 47-48 ONLY see GMC grill section- group 24/page 69

24-214-FC-G	GMC only	47-48		Inquire
24-214-FC	premium quality chrome	47-55	\$379.95	Inquire
24-214-FP	WHITE	47-55	\$324.95	Inquire

REAR BUMPERS

24-214-RC	premium quality chrome	47-53	\$379.95	Inquire
24-214-RP	WHITE	47-53	\$324.95	Inquire
24-214-4RC	premium quality chrome	54-55	\$379.95	Inquire
24-214-4RP	painting	54-55	\$324.95	

Give your truck a nice custom touch with this "Smoothie" bumper. The bumper comes with all hardware necessary for installation and eliminates the bumper bolts for a clean, custom, touch

24-214-FCS	NEW smooth-no bolt holes /chrome w/ hdw	47-53	529.95	
24-214-RPS	NEW smooth-no bolt holes / black w/ hdw	47-53	\$424.95	
24-214-RCS	NEW smooth-no holes/chrome w/hdw	47-53	\$529.95	

Bumper Bolts w/ hardware

Check all bumper bolts for dept of square collar-may require grinding down to prevent washer bottoming out

1-0BBC	chrome w/. High dome head	each	47-72	\$5.95
1-0BBS	stainless steel capped	each	47-72	\$5.95
1-0BBP	BLACK NEW ITEM	each	47-72	\$6.50

Bumper Guards---- Fits front or rear

Stamped steel, chrome plated .-	pair			
24-217		47-55	\$224.95	

Roll Pan 1947-53 smooth front roll pan mounts below grill and eliminates front splash pan and bumper.---**FIBREGLASS**

35-206-FRP	\$224.95
------------	----------

Bill's Truck Shop

Phone (905) 725-3460 / (905) 725-2022 / Fax (905) 404-2302 email: bill@billstruckshop.com

Splash Aprons

Due to the fluctuation of the Canadian and American dollars call for current prices

Group 25

25-201-S



25-201-SG



25-202-P



25-203-C



25-203-CB

25-203-4B



1947-53 Chev big truck 3" wider end to end



47-48 GMC bumper filler



Year New Used

Front Apron-bumper filler

25-201-S	steel	CHEV	47-53	\$169.95	Inquire
25-201-C	chrome	CHEV	47-53	\$274.95	
25-201-54S	steel	CHEV	54-55	\$159.95	Inquire
25-201-4C	chrome	CHEV	54-55	\$279.95	
25-201-SG-47	steel	GMC-does			
not recess in as far as 49-53			47-48		Inquire
			Late 49-53	\$199.95	Inquire
25-201-SG	steel	GMC	Late 49-53		
25-201-CG	chrome	GMC	53		inquire
25-201-4FG	fibreglass	GMC	54-55	\$139.95	

Rear Splash Apron-requires modification for 54-55 style drop-center bumpers

25-202-P	w/ fender ext-mounts at bumper	47-53	\$329.95		
25-202-SP	suburban, panel-fibreglass w/ bkts	47-55	\$145.00		

Front License Bracket

25-203-B	black	47-53	\$21.95		
25-203-C	chrome	47-53	\$23.95		
25-203-4B	black	54-55	\$14.95		
25-203-4C	chrome	54-55	\$29.95		

Front Plate Bracket Bolt set-secures bkt & plate

25-203-CB	4 stainless carriage bolts w/hdw	47-54	\$3.25		
-----------	----------------------------------	-------	--------	--	--

Rear Plate Bracket See group 17-18

Bill's Truck Shop

Phone (905) 725-3460 / (905) 725-2022 / Fax (905) 404-2302 email: bill@billstruckshop.com

Year New Used

Bed Wood-Boards are cut to size with edges grooved-Kiln dried

No bed mount holes in boards

NOTE>47-51 w/ 8 bed strips(**9 boards**) or 51-53 w/ 7 bed strips (**8 boards**) add \$70.00 when ordering w/ mount holes-special order

YELLOW PINE

26-2235	Short Step	47-51	Inquire
26-2167	pine-short step w/ mount holes	47-51	\$499.95
26-2249	Long Step 86'	47-51	Inquire
26-2191	Long Step 107' " 1 Ton	47-51	Inquire
26-2237	Short Step	51-53	Inquire
26-2251	Long Step 86'	51-53	Inquire
26-2193	Long Step 107" 1 Ton	51-53	Inquire
26-0239	Short Step	54-59	Inquire
26-0253	Long Step 89"	54-57	Inquire
26-0359	Long Step 107 1/4 " 1 Ton	54-59	Inquire

RED OAK

26-2234	Short Step	47-51	\$724.95
26-2248	Long Step 86'	47-51	\$759.95
26-2190	Long Step 107' 1 Ton	47-51	\$769.95
26-2236	Short Step	51-53	\$724.95
26-2250	Long Step 86'	51-53	\$759.95
26-2192	Long Step 107' 1 Ton	51-53	Inquire
26-0238	Short Step	54-59	\$724.95
26-0252	Long Step 89'	54-57	\$759.95
26-0433	Long Step 97' 1/4 1 Ton	54-59	Inquire

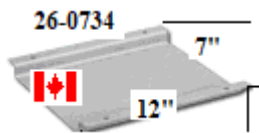

Heat Shield –to shield exhaust on wood floor over rear axle-prevents wood from burning

26-0734	galvanized/ includes hdw	each	47-72	\$33.95
---------	--------------------------	------	-------	---------

Bed Strips

Due to the fluctuation of the Canadian and American dollars call for current prices

Group 26

Stainless steel bed strips are magnetic grade 430 bright stainless steel Year New Used

Bed Strips

Stainless steel- pre punched w/ square holes 77"
47-51 uses **8 strips (9 boards)**
51-53 uses **7 strips(8 boards)**



Steel Punched

26-2015	Short Step 77"	each	47-53	\$24.95
26-2042	Long Step 86 "	each	47-53	\$29.95
26-2329	Long Step 107' 1 ton	each	47-53	\$39.95
26-0018	Steel-Short Step w/ 7pc	set	54-59	\$149.95
26-2045	Long Step 89' 7 pc	set	54-55	\$179.95
26-0684	Long Step 97' 1 Ton	set	54-59	\$199.95

Polished Punched--- 77"

26-2013	Short Step 77"	each	47-53	\$43.95
26-2040	Long Step 86"	each	47-53	\$54.95
26-2327	Long Step 107' 1 Ton	each	47-53	\$59.95
26-0016	Short Step w/7 pc	set	54-59	\$339.95
26-2043	Long Step 89'	set	54-55	\$379.95
26-0434	Long Step 107" 1 Ton	set	54-59	\$379.95

PANEL & CANOPY EXPRESS

Inquire about 1 ton panel & canopy express

SEE PICTURE FOR INFO

26-2664	Panel-Canopy Express 82" set has 4 short strips for wheel tubs-strips also sit UNDER end panel front and rear 12pcs PST ½ ton	47-51	\$349.95
26-????	Panel-Canopy Express 82" set has 4 short strips for wheel tubs-strips also sit UNDER end panel front and rear ? 12pcs STEEL	???????	
26-2495	Panel-Canopy Express 79 ½ " -strips end @ front and rear sill PST 5pcs ½ ton	51-54	\$225.95
26-2497	Panel-Canopy Express 79 ½ " -strips end @ front and rear sill STEEL 5pc ½ ton	51-54	\$129.95

27-2600-47

27-2600-52

Bed Bolt Kits

28-2590	Panel & Canopy Express ½ ton STEEL	47-51	\$125.00
No bolt kit for 51-55 Canopy & Panel			
28-2286	Panel & Canopy Express ½ ton PST	47-51	\$189.95
No bolt kit for 51-55 Canopy & Panel			

47-51---strips slide UNDER end covers at both ends bolts go through end plate and strips -total of 12 pcs



bolts are at end of strips -total of 5 strips
51-54---strips STOP at end covers at both ends

Bill's Truck Shop

Phone (905) 725-3460 / (905) 725-2022 / Fax (905) 404-2302 email: bill@billstruckshop.com

Bed Strips

Due to the fluctuation of the Canadian and American dollars call for current prices

Group 26

Stainless steel bed strips are magnetic grade 430 bright stainless steel Year New Used

BED STRIPS can be ordered for special one of a kind application- call for pricing

Stainless Steel w/ o holes

26-0634	78 “ long PST w/o holes	each	\$44.95
26-0160	89 “ long PST w/o holes	each	\$59.95
26-0336	120 “ long PST w/o hole	each	\$84.95

Steel w/ o holes

26-0007	77 1/8 long w/o holes	each	\$29.95
26-0008	97 “ long w/o holes	each	\$39.95
26-0383	120” long w/o holes	each	\$59.95

When installing the bed and angle strip bolts do not over tighten-collapse the lock washer only - the bed strips will BEND when they are over tightened



Custom “WOW” Bed Strips w/ hidden fasteners

Polished Stainless Steel: custom strips w/ "T" type bolt slides on bottom of strip

26-0095	‘T ‘ bolts w /hdw as required –short bed requires 7	each	\$6.00
26-0083	97 “ long - cut to fit	each	\$99.00

Custom Bed Strips w/ hidden fasteners



STRIP KIT

7 strips 82 “ w/ 49 “T” bolts and angle side hdw	
26-0083-K	\$699.95

Bill's Truck Shop

Phone (905) 725-3460 / (905) 725-2022 / Fax (905) 404-2302 email: bill@billstruckshop.com

Angle Strips/Covers

Due to the fluctuation of the Canadian and American dollars call for current prices

Group 27

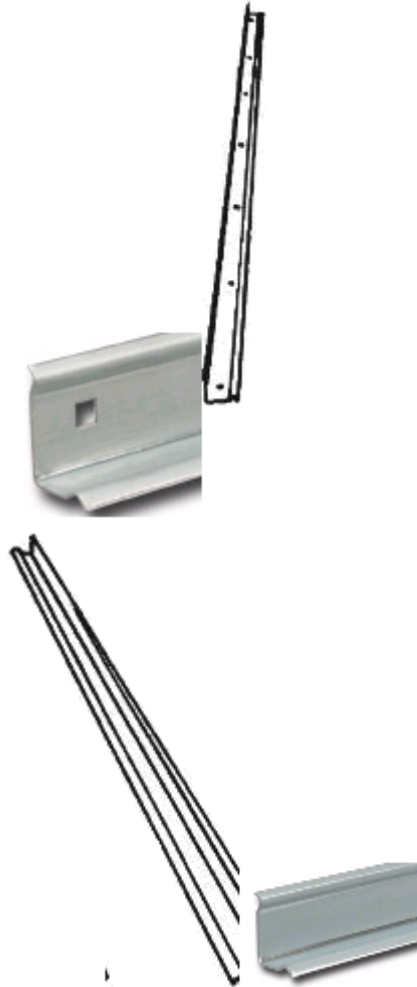

Angle Strips

Steel Punched -sold as pr

		<u>Year</u>	<u>New</u>	<u>Used</u>
27-2111	Short Step	47-53	\$74.95	
27-2132	Long Step 86'	47-53	\$89.95	
27-2600	Long Step 1 Ton 107 "	47-53	104.95	
27-0114	Short Step	54-59	\$74.95	
27-2135	Long Step 89'	54-55	\$94.95	
27-0140	Long Step 1 Ton	54-59	\$99.95	

Polished Punched -sold as pr

27-2109	Short Step	pair	47-53	\$129.95
27-2130	Long Step 86"	pair	47-53	\$139.95
27-2602	Long Step 107 "1 Ton		47-53	\$149.95
27-0112	Short step		54-59	\$119.95
27-2133	Long Step 89'		54-55	\$139.95
27-0437	Long Step 97' 1 Ton		54-59	\$159.95

Angle Cover Designed to cover the existing angle strip or as a replacement w/o holes Holes must be drilled at time of installation to match the original strip.

Steel (pair)

27-0139	97 " long			\$55.00
---------	-----------	--	--	---------

When installing the bed and angle strip bolts do not over tighten-collapse the lock washer only - the bed strips will collapse when they are over tightened

Bill's Truck Shop

Phone (905) 725-3460 / (905) 725-2022 / Fax (905) 404-2302 email: bill@billstruckshop.com

Bed Bolts

Due to the fluctuation of the Canadian and American dollars call for current prices

Group 28



Bed Bolt Kits Includes all necessary bolts, washers and nuts for mounting bed strips to wood and bed to frame. For replacement strips w/square holes. **Stainless steel bolts** are a non-magnetic grade w/ superior resistance to rust and corrosion

Ribbed bolt kits available (Inquire)

			<u>Year</u>	<u>New</u>	<u>Used</u>
Zinc (BS = bed strips)					
28-2350	Short step w/ 8 BS	77"	47-51		\$84.95
28-2377	Long Step 86". w/ 8 BS		47-51		\$84.95
28-2272	Long Step 107" 1 Ton .w/ 8 BS		47-51		\$99.95
28-2353	Short Step- w/ 7 BS		51-53		\$89.95
28-2275	Long Step 86".w / 7 BS		51-53		\$94.95
28-2278	Long Step 107" I Ton, w/ 7 BS		51-53		\$99.95
28-2356	Short Step		54-55		\$84.95
28-2281	Long Step 89"		54-55		\$84.95
28-0358	Long Step 97" I Ton		54-59		\$99.95

Polished Stainless Steel

28-2348	Short Step w/ 8 BS		47-51		\$199.95
28-2375	Long Step 86".w/ 8 BS		47-51		\$219.95
28-2270	Long Step 107"/1 ton w/ 8 BS		47-51		\$221.95
28-2351	Short Step w/ 7 BS		51-53		\$199.95
28-2273	Long Step 86" w/ 7 BS		51-53		\$219.95
28-2276	Long Step 107" I Ton w/ 7 BS		51-53		\$221.95
28-2354	Short Step		54-55		\$194.95
28-2279	Long Step 89"		54-55		\$199.95
28-0439	Long Step 97" 1 Ton		54-59		\$199.95

Bed to Frame Bolt Kits

Zinc					
28-2414	Short Step		47-53		\$44.95
28-2429	Long Step 86"		47-53		Inquire
28-2417	Short Step		54-55		Inquire
28-0432	Long Step 89"		54-57		Inquire
Polished					
28-2412	Short Step		47-53		\$84.95
28-2427	Long Step 86"		47-53		Inquire
28-2415	Short Step		54-55		\$84.95
28-0430	Long Step 89"		54-57		Inquire

Bill's Truck Shop

Phone (905) 725-3460 / (905) 725-2022 / Fax (905) 404-2302 email: bill@billstruckshop.com

Bed Bolts

Due to the fluctuation of the Canadian and American dollars call for current prices

Group 28



28-0211



28-0114-P

bolts through bed sills only-dome bottom of boards- for the clean floor look



Angle & Strips Bolt kit -PST Use this kit when hiding bed to frame bolts under your boards

28-2343

Year New Used

51-53 \$79.00

Bed Floor Offset Washers

28-0211 1 ½ w/ offset square hole-stainless steel each

\$12.95

28-0211-S 1 ½ w/ offset square hole-stainless steel each

\$2.50

BOLTS

28-0114-P ¼ x 1' NC carriage bolt-PST w/ lock washer & nut each

\$2.75

Bill's Truck Shop

Phone (905) 725-3460 / (905) 725-2022 / Fax (905) 404-2302 email: bill@billstruckshop.com

Front Bed Panels

Due to the fluctuation of the Canadian and American dollars call for current prices

Group 28



28-2800-CS

Front Bed Panel Exact gauge with proper bends. 1947-53 front bed panels, includes mounting rod.

		<u>Year</u>	<u>New</u>
28-2609	½ & ¾ ton made in USA	47-53	\$249.95
28-2609-T	½ & ¾ ton made in Taiwan	47-53	\$189.95
28-2610	1 ton-has extra reinforce support brace USA made	47-51	\$474.95
28-2611	1 ton-has extra reinforce support brace USA made	51-53	\$474.95
28-0354-T	made in Taiwan	54-59	\$179.95

Embossed with Chevy Bowtie-special order only

28-2695	½ and ¾ ton	47-53	\$265.00
28-0696	step side	54-59	\$199.00

Front Bed Panel Mounting Bolts w/hdw

Zinc

28-2630-Z	8 bolts w/ washers & nuts zinc	47-53	\$5.95
23-0387-S	Cap screw style steel---step & fleet side	54-72	\$11.95

Stainless Steel

28-2800-CS	stainless steel carriage bolt w/ flat, lock washers & nuts-gives a smooth look to bed side mounting	47-53	\$12.00
28-2630-S	8 bolts w/ washers & nuts-stainless steel	47-53	\$8.00
23-0387-SS	Phillips head stain-steel / step & fleet	54-72	\$19.95

ALL US Made Bed parts are galvanized steel and not primed-Taiwan (T) are black primer

Bill's Truck Shop

Phone (905) 725-3460 / (905) 725-2022 / Fax (905) 404-2302 email: bill@billstruckshop.com

Tailgates & Covers

Due to the fluctuation of the Canadian and American dollars call for current prices

Group 29



		<u>Year</u>	<u>New</u>	<u>Used</u>
Tailgates				
Complete - Stamped steel with correct bends-16 gage electro-galvanized steel US and Taiwan (T) black primer 1947-53 bed is side angle top—1954 up is side flat top				
Chevrolet w/ block letters				
29-2643	US made	47-53	\$499.95	
29-2905	w/ hidden latches & link assembly	47-53	Inquire	
29-2643-T	Taiwan made/black primer	47-53	\$389.95	
23-0SCHEV	step side /Chevrolet US made	54-87	Inquire	
23-0SCHEV-T	step side/Chevrolet-Taiwan made	54-87	\$429.95	
GMC w/ script letters				
29-2644	US made	47-53	\$459.95	
29-2644-T	Taiwan made/black primer	47-53	\$399.95	
23-2906	w/ hidden latch & link arms installed	47-53	Inquire	
23-2GMC	step side with original GMC script	54-54	\$595.95	
23-0SGMC	step side new style letters	54-87	\$449.95	
23-0SGMC-A	step side with original GMC script	55-62	\$479.95	
Blank (smooth)				
29-2630-T	Taiwan made	47-53	\$306.95	
23-0SBLANK	Taiwan made	54-87	\$299.95	
Bowtie (embossed) special order				
23-0694	US made	54-87	\$469.95	
Louvered w / rows special order				
29-2335	4 row louvered	47-53	Inquire	
COVER (weld on or screw on)				
29-2754	Smooth	47-53	\$158.95	
23-0758	Smooth	54-87	\$158.95	

Bill's Truck Shop

Phone (905) 725-3460 / (905) 725-2022 / Fax (905) 404-2302 email: bill@billstruckshop.com

Tailgate Hardware

Due to the fluctuation of the Canadian and American dollars call for current prices

Group 29

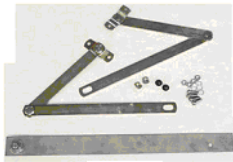

29-2835



22-0SLK-S



29-210



23-0SZ



22-0CCB

22-0547-S

23-0381



29-212-S

29-212-SS



Tailgate Link kit- w/ instructions

29-2835 ZINC-arms w/ hdw for removal of chains

Year New Used

41-53 \$169.95

29-2835-S stainless steel-arms w/ hdw for removal of chains

41-53 \$324.95

29-0834 arms w/ hdw for removal of chains

54-87 \$169.95

29-0834-S arms w/ hdw for removal of chains

54-87 \$224.95

stainless steel

Step side Stealth Tailgate Latches (pair)

Slotted stainless barrel w/spring loaded lock pin that is installed into the top gate roll & inserts in gate post

22-0SLK-S stainless steel

pair 41-87 \$119.95

22-0SLK-Z zinc coated

pair 41-87 \$94.95

Tailgate Chains

29-210 cadmium plated-pr

32-53 \$44.95 \$20.00

29-210-SS stainless steel-pr

32-53 \$79.95

23-0SZ zinc

54-87 \$94.95

23-0SS stainless steel

54-87 \$79.95

Tailgate Chain Covers

22-0CCB black-

pair 47-87 \$11.95

22-0CCC clear-

pair 47-87 \$11.95

Tailgate Trunions (Hinge)

29-212-SS chrome

pair 41-53 \$69.95

29-212-S steel

pair 41-53 \$43.95

22-0547-S zinc w bolts

pair 54-87 \$29.95

23-0381 urethane w/ SS bolt

pair 54-87 \$52.95

Bill's Truck Shop

Phone (905) 725-3460 / (905) 725-2022 / Fax (905) 404-2302 email: bill@billstruckshop.com



30-201-B

23-0CSB



23-0GSB

30-201-2B



30-201-W

30-201-CR

Tailgate Letters-stick decals

Black

		<u>Year</u>	<u>New</u>	<u>Used</u>
30-201-B	CHEVROLET / black	47-53	\$9.95	
23-0CSB	CHEVROLET / black	54-87	\$9.95	
30-201-2B	GMC / black	47-53	\$9.95	
23-0GSB	GMC / black	54-87	\$9.95	

White

30-201-W	CHEVROLET / white	47-53	\$9.95	
23-0CSW	CHEVROLET / white	54-87	\$9.95	
30-201-2W	GMC / white	47-53	\$9.95	
23-0GSW	GMC / white	54-87	\$9.95	

Chrome

30-201-CR	CHEVROLET / chrome	47-53	\$9.95	
23-0CSC	CHEVROLET / chrome	54-87	\$9.95	
30-201-2CR	GMC / chrome	47-53	\$9.95	
30-201-2SS	GMC / brushed stainless	47-53	\$9.95	
23-0GSS	GMC / brushed stainless	54-87	\$9.95	

Grey

30-201-G	CHEVROLET / grey	47-53	\$9.95	
----------	------------------	-------	--------	--

Bill's Truck Shop

Phone (905) 725-3460 / (905) 725-2022 / Fax (905) 404-2302 email: bill@billstruckshop.com

Bed Cross Sills

Due to the fluctuation of the Canadian and American dollars call for current prices

Group 29

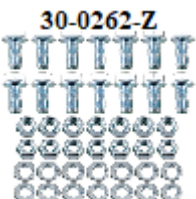
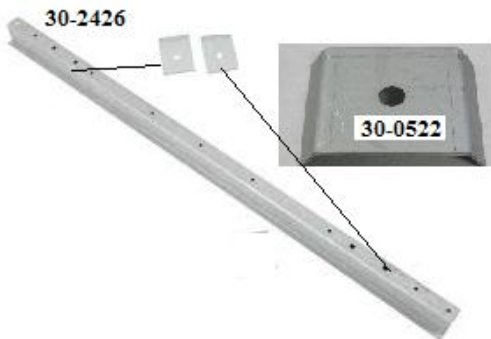
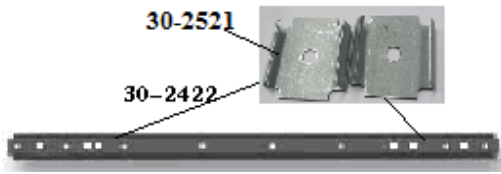

ALBED CROSS LISTED BELOW ARE 1/2 TON
 47-53 short beds use 1 front, 2 center and 1 rear cross sill---long step beds use 1 front, 4 center and 1 rear cross sill /// 54-55 uses 3 cross sills
NOTE>47-51 w/ 8 bed strips(**9 boards**) or 51-53 w/ 7 bed strips (**8 boards**)

Bed Cross Sill Includes bed support plates and are predrilled for strips & brackets (BS = bed strips)

		<u>Year</u>	<u>New</u>	<u>Used</u>
30-2422	front w/ 8 BS-drilled for fit bed panel	47-51	\$69.95	
30-2423	center w/ 8 BS	47-51	\$69.95	
30-2599	2 nd sill @ fuel tank-w/ recess for under bed tank-does not bolt to frame	47-48	\$139.95	
30-2424	front w/ 7 BS-drilled for fit bed panel	51-53	\$69.95	
30-2425	center w/ 7 BS	51-53	\$69.95	
30-2426		54-55	\$69.95	

Cross Sill Support Plates-step side

30-2521		pair	40-53	\$7.50
30-0522	between sill and frame w/ bolt hole	each	54-87	\$2.50

Rear Cross Sill ---- 1/2 ton frame 44"

30-2627	1/2 ton w/ 8 BS	47-51	\$219.95	
30-2628	3/4 ton w/ 8 BS	47-51	\$295.95	
30-2629	1 ton w/ 8BS	47-51	\$324.95	
30-2617	1/2 ton w/ 7 BS	51-53	\$199.95	
30-2618	3/4 ton w/ 7BS	51-53	\$269.95	
30-2619	1 Ton w/ 7 BS	51-53	\$324.95	
30-2713	1/2 ton	54-55	\$199.95	
30-2714	3/4 Ton	54-55	\$269.95	

Reinforcement Strip on bed floor at wheels

30-0437	54-59 long step & 58-59 fleet	54-59	\$44.95	
23-0706	w/ out holes	54-87	\$29.00	

30-0262-Z	Rear cross sill hdw-kit 42pcs	37-53	\$19.95	
-----------	-------------------------------	-------	---------	--

Bill's Truck Shop

Phone (905) 725-3460 / (905) 725-2022 / Fax (905) 404-2302 email: bill@billstruckshop.com

Roll Pans and Hardware

Group 30

30-2604-T



30-0826-T



30-0204-T

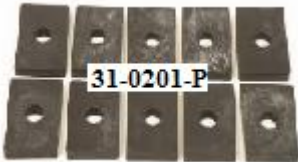

31-0201-P

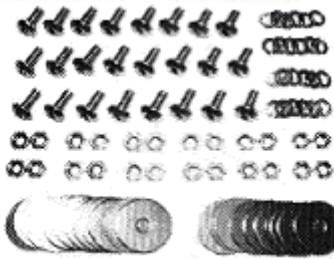

31-0202-SS



31-0WFB

30-2724-L



30-2724

Rear Roll Pan (Steel) Welds or screws to rear cross sill & bed sides-rear cross sill will have to be cut to accept plate box—**FIT SHORT BED ONLY**----- side extension to fender approx 8” long

-with License Plate Box

30-2604-T smooth-made in Taiwan 47-53 \$229.95

30-0826-T smooth-made in Taiwan 54-87 \$224.95

30-0852 4 row louvered USA made 54-87 Inquire

24-0483 smooth – **long step step** USA made 54-87 \$279.95

-without License Plate Box-using original side mount plate bkt for license plate

30-2816 smooth 47-53 \$189.95

30-2836 4 Row Louvered 47-53 \$239.95

24-0817 smooth w/ out plate box 54-87 \$224.95

24-0839 4 Row Louvered 54-87 \$239.95

Rear Roll Pan Tag Light For rear roll pan with license plate box

30-0204-T top mount \$6.50

Bed Mounting Blocks and Pads hardwood & rubber pads

30-2724 short bed 47-53 \$26.95

30-2724-L long bed 47-53 \$36.95

Bed Mounting Pads – Rubber

31-0201-P 10 pcs 54-72 \$14.95

Rear Step Fender Bolt Kit w/washers and nuts.

31-0202-SS stainless steel w/clutch head screw 47-66 \$62.95

31-0202-SS-P stainless steel w/philips head screw 47-66 \$59.95

25-06025 zinc w/ Philips head 47-72 \$19.95

Rear Step Fender Welt Beading

31-0FWB black vinyl 25' 47-72 \$21.95

Bill's Truck Shop

Phone (905) 725-3460 / (905) 725-2022 / Fax (905) 404-2302 email: bill@billstruckshop.com

Bed Sides

Due to the fluctuation of the Canadian and American dollars call for current prices

Group 31

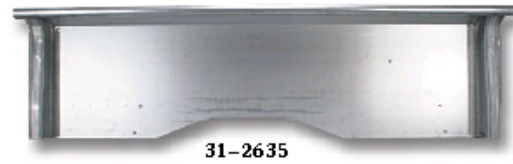

31-2635

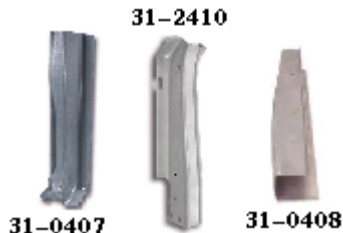

31-0407

31-2410

31-0408

fender lines embossed

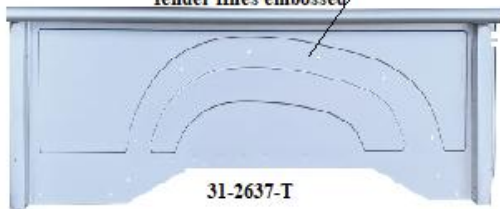

31-2637-T

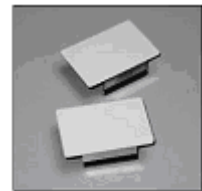

23-2190

Bed sides are made from 16 gauge electro-galvanized steel and come with angels installed, stake pockets, fender holes, USA are not primed. Bed sides can be ordered with many different options: e.g., no pocket holes SS angels, no fender holes. . Inquire if necessary .Items w/ T are off shore produced parts

Taiwan (T) are also OE style and are black primer
Bed sides can be ordered w/out chain & latch bracket-add \$25.00 per side

					<u>Year</u>	<u>New</u>	<u>Used</u>
31-2635	US made	short bed	left	47-53		Inquire	
31-2635-T	Taiwan made	short bed	left	47-53		\$699.95	
31-2636	US made	short bed	right	47-53		Inquire	
31-2636-T	Taiwan made	short bed	right	47-53		\$699.95	
31-2734	US made w/o stake pocket holes-		left	47-53		Inquire	
31-2735	US made w/o stake pocket holes		right	47-53		Inquire	
31-2540	86" 3/4 long bed		left	47-53		\$979.95	
31-2541	86" 3/4 long bed		right	47-53		\$979.95	
31-2637	w/o fender embossed	short bed	left	54-55		\$699.95	
31-2638	w/o fender embossed	short bed	right	54-55		\$699.95	
31-2637-T	w/fender embossed	short bed	left	54-55		\$799.95	
31-2638-T	w/fender embossed	short bed	right	54-55		\$799.95	
31-2542		long bed	left	54-55		Inquire	
31-2543		long bed	right	54-55		Inquire	
Stake Pocket Vertical support at front & rear of step side bedside							
31-0407	front	left or right		41-53		\$99.95	
31-2413	rear	left		47-53		\$129.95	
31-2410	rear	right		47-53		\$129.95	
31-0408	front	left		54-72		\$99.95	
31-0405	front	right		54-72		\$99.95	
23-0411	rear	right		54-66		\$139.95	
23-0414	rear	left		54-66		\$139.95	

NOTE--47-53 bedsides have an angle top and 54 and up are flat on top

Stake Pocket Covers – steel w/ side clips

23-2190	steel/pair	47-53	\$44.95
23-0191	steel/pair	54-87	\$44.95

All truck shipments will have a \$20.00 crating fee for materials

Bill's Truck Shop

Phone (905) 725-3460 / (905) 725-2022 / Fax (905) 404-2302 email: bill@billstruckshop.com

Bed Parts

Due to the fluctuation of the Canadian and American dollars call for current prices

Group 31

31-0649

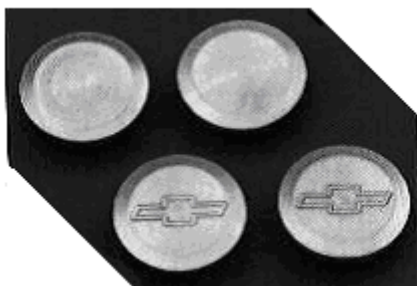

31-0752



22-0SLK-S



31-0864



22-0LFP

Year New Used

Bed Hole Plugs Aluminium plug fits in hole at front and rear of *step side* bed rails. With rubber O-ring -- press in

Blank aluminium polished

31-0649 aluminum-polished-smooth pair 47-66 \$89.95

31-0649-B aluminum-brushed pair 47-66 \$59.95

STEPSIDE TAILGATE EDGE PROTECTOR

Screw & or urethane to gate

22-0STP-B black satin stainless steel 54-87 \$79.95

22-0STP brushed stainless steel 54-87 \$79.95

Step side Stealth Tailgate Latches (pair)

These latches are great for people who are trying to eliminate the tailgate chains front their step side truck. These hidden latches use a slotted tubular channel to guide a spring loaded locking pin. They can be mounted inside the tailgate where they are completely out of sight. Only a small actuating knob is visible.

22-0SLK-S stainless steel 47-87 \$89.95

22-0SLK-Z zinc coated pair 47-87 \$89.95

Bed Roll Light kit-fit 40-66 bed rolls and 40-87 Mar-k made bed side roll

31-0864 dual intensity LED lights w/ hdw & instructions 50-66 \$229.95

Check our website www.billstruckshop.com for trucks and parts

22-0FLP
Flip down rear plate bkt \$39.95

Bill's Truck Shop

Phone (905) 725-3460 / (905) 725-2022 / Fax (905) 404-2302 email: bill@billstruckshop.com

Running Boards & Parts

Group 32

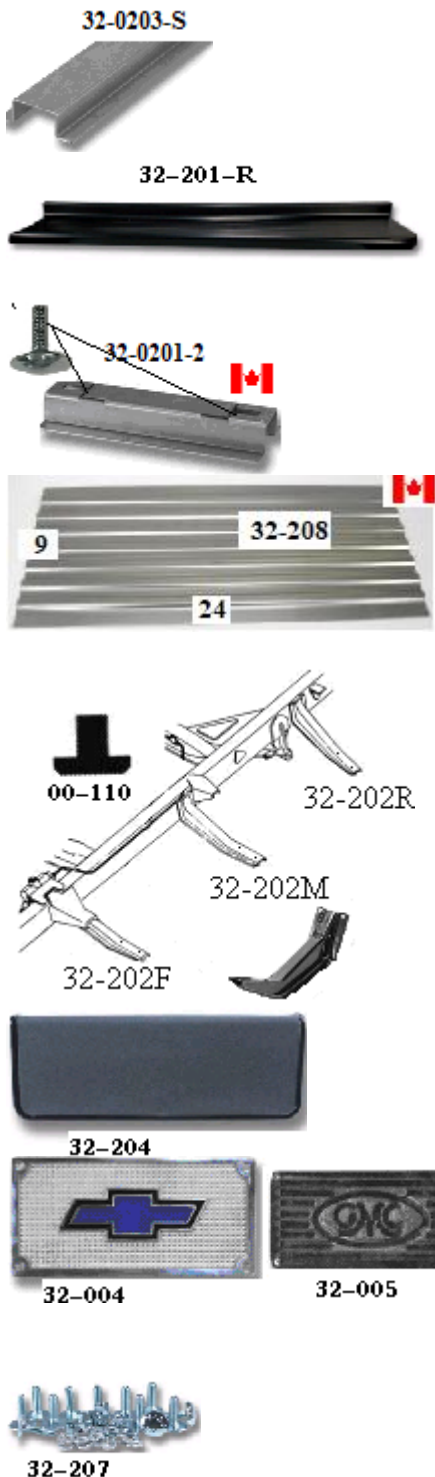

Running boards - ribbed like original w/ support brackets

			<u>Year</u>	<u>New</u>	<u>Used</u>
32-201-R	short bed	R	47-55	\$579.95	Inquire
32-201-RC	CHROME/short bed	R	47-55	\$564.95	
32-201-L	short bed	L	47-55	\$479.95	Inquire
32-201-LC	CHROME/short bed	L	47-55	\$564.95	
32-201-LL	long bed	R	47-55		Inquire
32-201-RL	long bed	L	47-55		Inquire

32-0201-2 7' long - trim for location - each 34-55 \$19.95

32-101-9 9" long trim for location- each 34-46 \$19.95

Running board Underside Reinforcement Brackets

32-0203-S 30 "brace that is welded to running board w/ weld in holes for easy install each 34-55 \$24.95

Running board Patch Panel

32-208 18 gauge-- 9" W x 24" L each 47-55 \$38.95

Running board Support – frame to running board-ft & center fit all models / center is also on the rear of all long step side trucks

32-202-LK 3 pc set for **left** side-1/2 ton 47-55 \$236.95

32-202-RK 3 pc set for **right** side -1/2 ton 47-55 \$236.95

32-202-FL front left all models 47-55 Inquire \$35.00

32-202-FR front right all models 47-55 Inquire \$35.00

32-202-ML middle left all models and rear on 3/4 up long step 47-55 Inquire \$35.00

32-202-MR middle right all models and rear on 3/4 up long step 47-55 Inquire \$35.00

32-202-RL rear left 1/2 ton 47-55 Inquire \$35.00

32-202-RR rear right 1/2 ton 47-55 Inquire \$35.00

Support Rivets-used on all cab. running board, shock etc brackets- for the original look \$0.30

00-110 5/16 x 1/2 soft steel

Running board Safety Treads – reproduction of an original GM accessory

32-204 black w/ non slip finish-9x21 pr w/ hdw 47-55 \$109.95

Running board Step Plates pair w / hdw

32-004 polished alum w/Chev bowtie-5 1/2 x11-pr \$99.95

32-005 non pol alum w /older GMC design 5x10 5/8-pr \$89.95

Running board Bolt Kit –includes bolts in running board for skirt bkt -- 1 per board

32-0207 steel - for 2 sides 36-55 \$16.95

Bill's Truck Shop

Phone (905) 725-3460 / (905) 725-2022 / Fax (905) 404-2302 email: bill@billstruckshop.com

Running Board Parts

Due to the fluctuation of the Canadian and American dollars call for current prices

Group 32



			<u>Year</u>	<u>New</u>	<u>Used</u>
Cab to Running board Seals					
32-205	pickup	pair	47-55	\$32.95	
32-205-1	panel/suburban		47-55	\$32.95	
Running board Seal Retainer					
32-205-2	pickup 1 per side-- 2 per side on panel/suburb	each	47-55	\$15.95	
Running board Seal Retainer Screw Set					
32-205-3		18 pcs	47-55	\$5.95	
Running board Rear Fender Seals (pair)					
32-205-4			47-55	\$9.95	
Running board Splash Apron w/o support					
32-206-LSS	short step-left		47-53	\$99.95	
32-206-RSS	short step-right		47-53	\$99.95	
32-206-LLS	long step-left		47-53	\$129.95	\$50.00
32-206-RLS	long step-right		47-53	\$129.95	\$50.00
32-206-4LSS	short step-left		54-55	\$104.95	
32-206-4RSS	short step-right		54-55	\$104.95	
32-206-4LLS	long step-left		54-55		\$50.00
32-206-4RLS	long step-right		54-55		\$50.00
Splash Apron Support w/ hdw					
32-206-S	L or R	each	47-53	\$19.95	
32-206-4S	L or R	each	54-55	\$19.95	
Running board Bolt Kit –includes bolts in running board for skirt bkt -- 1 per board					
32-207	steel - for 2 sides		47-55	\$16.95	
Panel-Suburban rear door-gate					
32-0105-R	lift gate recoiled/counterbalance-each		47-59	\$114.95	

Bill's Truck Shop

Phone (905) 725-3460 / (905) 725-2022 / Fax (905) 404-2302 email: bill@billstruckshop.com

Sheet Metal Repair Panels

Group 33



Inner Cowl Panel-

			<u>Year</u>	<u>New</u>	<u>Used</u>
33-203-L	9 " high	left	47-55	\$44.95	
33-203-R	9 " high	right	47-55	\$44.95	
33-203-LT	25 " high w/ vent louvers	left	47-50	\$69.95	
33-203-1LT	25 " high w/ out vent louvers-(BUT can be installed)can also be used on 47-50 if closing left outer vent	left	50-55	\$69.95	
33-203-1L-A	full replacement panel w/o louvers -install @ OE seams	left	50-55	\$99.95	
33-203-RT	25 " high w/ dlx heater opening	right	47-55	\$74.95	
33-203-RT-A	full replacement panel w/ dlx heater opening -install @ OE seams	right	47-55	\$105.95	

Outer Cowl - 16 " high

33-204-R		right	47-55	\$99.95	
33-204-L		left	47-55	\$99.95	

Outer Cowl- "T" are full replacement panels

33-204-LT47	w/ cowl vent opening	NEW left	47-50	\$119.95	
33-204-LT	w/ out cowl vent opening for 47-50	left	47-55	\$119.95	
33-204-RT	w/ louvers	right	47-55	\$129.95	

Inner /Outer Cowl - "T" are full replacement panels

33-205-R	12' high	right	47-55	\$59.95	
33-205-L	12" high	left	47-55	\$59.95	
33-205-LT	24 " high	left	47-55	\$99.95	
33-205-RT	24" high	right	47-55	\$99.95	

Hinge Pocket-front lower a "A" pillar-hinge nut w/ cage not included 13" tall

33-206-L		left	47-55	\$86.95	
33-206-R		Right	47-55	\$86.95	

Lower Cab Rear "B" Pillar- door post lower @ rocker

33-220-L	12"	left	47-55	\$69.95	
33-220-R	12"	right	47-55	\$69.95	

Bill's Truck Shop

Phone (905) 725-3460 / (905) 725-2022 / Fax (905) 404-2302 email: bill@billstruckshop.com

Sheet Metal Repair Panels

Group 33



Cab Corner

		<u>Year</u>	<u>New</u>	<u>Used</u>
33-209-L	15 " high & into door opening	47-55	\$89.95	
33-209-R	15" high & into door opening	47-55	\$89.95	

Inner Cab Corner

33-209-1L-47	left	47-48	NLA	
33-209-1R-47	right	47-48	NLA	
33-209-1L	left	47-55	\$59.95	
33-209-1R	right	47-55	\$59.95	

Front Fender Rear Lower-approx 18" high

33-230-L	left	47-55	\$219.95	
33-230-R	right	47-55	\$219.95	

Front Fender Front Lower

33-231-L	13 ¾ H	left	47-55	\$169.96
33-231-R	13 ¾ H	right	47-55	\$169.95

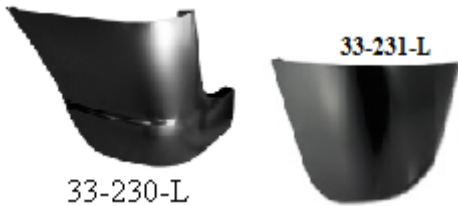

Front Cab Support

33-218-L	left	47-55	\$69.95	
33-218-R	right	47-55	\$6.95	

Rear Cab Support- come on 49-55 w/ side shackle mount only but need to be installed when changing 47-48 cabs to side shackle mount

33-219	fits right & left	49-55	\$46.95	
--------	-------------------	-------	---------	--



Rocker Panel (note can also be used on COE cabs)

33-207-L	left	47-55	\$83.95	
33-207-R	right	47-55	\$83.95	



Bill's Truck Shop

Phone (905) 725-3460 / (905) 725-2022 / Fax (905) 404-2302 email: bill@billstruckshop.com

Sheet Metal Repair Panels

Group 33

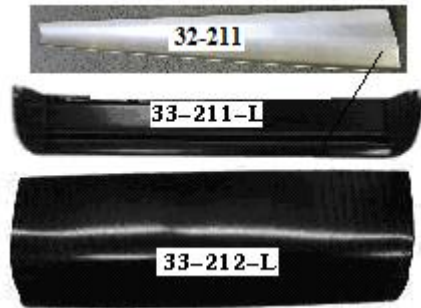

Inner Door Lower 5 1/2" high

		Year	New	Used
33-211-L	left	47-55	\$79.95	
33-211-R	right	47-55	\$79.95	
32-211	universal inner lower repair panel			
2 1/2 H x 32 1/2 L	fits left & right	47-55	\$24.95	

Outer Door Bottom 12" high

33-212-L	left	47-55	\$79.95	
33-212-R	right	47-55	\$79.95	

Retainer-Brake & clutch seat -w/ weld in holes

7-203-47R	1 1/2 " wide	pair	47-51	\$12.95
7-203-52R		pair	52-55	\$12.95

Floor Pan w/Toe board-all repro floor pans are made to use the smaller 47-51 seal retainer and are not installed on NEW pans w/o trans support see 33-217-SL & SR

33-217-1L	w/ 9" toe board	left	47-55	\$144.95
33-217-1R	w/ 9 " toe board	right	47-55	\$144.95

Support-floor pan edge @ trans cover (do not come w/ replacement floor pans)

33-217-SL			47-55	\$14.95
33-317-SR			47-55	\$14.95

Transmission Floor Cover 1/2 -1 ton

8-208	column shift		47-55	\$92.95
8-208-1	4-speed		47-55	\$119.95
8-208-A	w/ automatic trans		47-55	Inquire

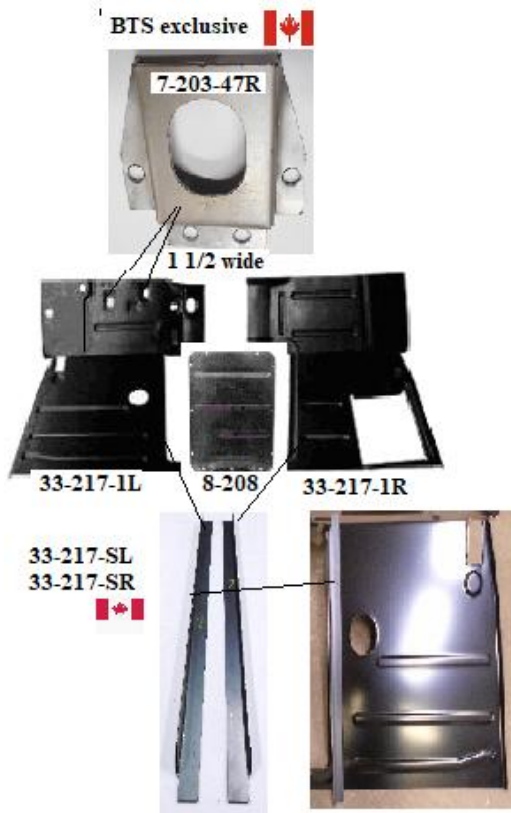

Check our website www.billstruckshop.com for California trucks and parts

Bill's Truck Shop

Phone (905) 725-3460 / (905) 725-2022 / Fax (905) 404-2302 email: bill@billstruckshop.com

Sheet Metal Replacement Parts

Group 34



34-219-C

34-219-GS



49"

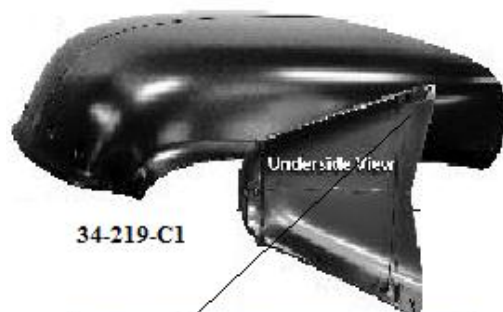

34-219-C1

Underside View



34-219-LB

34-219-RB



34-2112-SS



34-2112-HK



34-2113-B

Hood --CHEV

		Year	New	Used
34-219-C	Chev	47-53	Inquire	Inquire
34-219-C1	2 pcs w/o emblem embossed acentre strip slits	Chev	47-55	
34-219-CS	1 pc hood w/o center strip slits w/ emblem embossed	Chev	47-55	\$1194.95

HOOD--GMC

34-219-G	2 pc GMC	47-55	Inquire	Inquire
34-219-GS	1 pc/seamless hood GMC	47-55	\$999.95	

GMC hood for 1/2-3/4 ton approx. 49" long from front to rear on side emblem line—bigger truck are approx. 52 "

Hood Braces Chev & GMC used only w/ good hinge bolt holes & NO rust through or stripped holes

34-219-LB	rear brace- left	47-55		\$125.00
34-219-RB	rear brace right	47-55		\$125.00

Hood Latch Panel-----CHEV

34-2112-SS	stainless steel w/ release	Chev	47-55	\$424.95	
34-2112-B	black w/ release	Chev	47-55	\$329.95	\$150.00
34-2112-BWL	black w/o release	Chev	47-55	\$199.95	
34-2112-HK	stainless Philips drive bolts w/ washers excellent kit for the stainless latch panel 12 bolts w/ wash		47-55	\$15.95	

Hood Latch Panel-----GMC

34-2113-B	black w/ out latch	GMC	47-55	\$209.95	\$100.00
34-2113-C	chrome w/ latch	GMC	47-55	\$307.00	

See section 3 for hood latches

Bill's Truck Shop

Phone (905) 725-3460 / (905) 725-2022 / Fax (905) 404-2302 email: bill@billstruckshop.com

Sheet Metal Replacement Parts

Group 34

Year New Used



Bill's Truck Shop

Phone (905) 725-3460 / (905) 725-2022 / Fax (905) 404-2302 email: bill@billstruckshop.com

Sheet Metal Replacement Parts

Group 34



34-220-R

Inner Fender 3 per side - holes to be drilled for GMC grille supports

34-220-L left 47-55 \$269.95 \$125.00

34-220-R 47-48 truck did not have a push pedal park brake & inner fender bolted directly to firewall-they will require # 34-220-S to install the replacement right inner on 47-48--- also have 6 " round holes in front w/ rubber liner for grille support bar 47-55 \$269.95 \$125.00

7-204-BS



34-220-S

34-220-S1

Support-inner fender w/ park brake

34-220-S on L firewall for inner fender & park support 47-55 \$89.95 \$30.00

34-220-S1 new replacement inner to outer fender support when NOT installing the OE style park brake assembly-----NEW ITEM 47-55 \$29.95



34-2113-U

GMC

Upper Rad Support Brace

34-2113-U 47-55 \$159.95 \$75.00



34-2113-F

Upper Front Rad Shroud

34-2113-F 47-55 \$189.95 \$75.00



34-2113-B

Bill's Truck Shop

Phone (905) 725-3460 / (905) 725-2022 / Fax (905) 404-2302 email: bill@billstruckshop.com

Sheet Metal Replacement Parts

Group 34



34-221-RBR



34-213-BK

When purchasing rad supports (Chev or GMC) please confirm after viewing pictures at bottom of page---some GMC w/ Chev 6 cyl will have a Chev Rad support

Rad Support

34-213-C Chev has side by side mounts on bottom-----includes fender support braces 5 pcs	47-55	\$699.95	
34-213-CB has side by side mounts on bottom ---- -----w/o out fender support braces 3 pcs	47-55	\$475.95	Inquire
34-213-UB ----rad support upper cross brace-w/nut installed--not included in new rad supports -Chev only- can also be used when installing Chev rad (top fill) in GMC truck (rad front fill)-secures hood latch panel to support when NOT using upper GMC cover /bar #34-2113-F	47-55	\$79.95	
34-213-G GMC -does not use upper cross brace-see previous page for GMC upper hood latch braces & panels	49-55	\$499.95	\$150.00

Upper Rad Support Brace

34-2113-U	47-55	\$139.95	\$75.00
-----------	-------	----------	---------

Bolt-kit-rad support

34-213-BK	28 pcs	47-55	\$34.95
-----------	--------	-------	---------

Fender-Rad Support Brace

34-221-RBR	½ -3/4- 1 ton	right	47-55	\$89.95	\$40.00
34-221-RBL	½ -3/4- 1 ton	left	47-55	\$89.95	\$40.00
34-221-RB	truck w/ 18 wheels and up	each L or R	47-55		\$50.00

Bill's Truck Shop

Phone (905) 725-3460 / (905) 725-2022 / Fax (905) 404-2302 email: bill@billstruckshop.com



brace on top



Sheet Metal Replacement Parts

Group 34



34-221-FS



34-221-SB



34-243

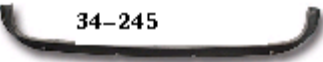

34-245

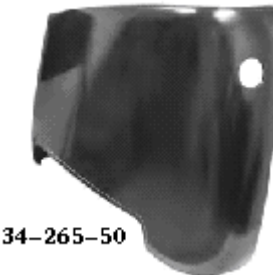

34-265-50



34-221-47L

park light hole

Front Fender Bolt kit-inner & outer fenders

34-221-FS stainless steel bolts, washers, nuts, screws 47-55 \$46.95

Fender -Firewall Braces-firewall to fenders

34-221-SB left or right w/ bracket each 47-55 \$39.95 \$25.00

34-211-BSS stainless steel w/ bkt & hdw pair 47-55 \$134.95

Fender-Rad Support Brace

34-221-RBR 1/2 -3/4- 1 ton right 47-55 \$89.95 \$40.00

34-221-RBL 1/2 -3/4- 1 ton left 47-55 \$89.95 \$40.00

34-221-RB truck w/ 18 wheels and up each L or R 47-55

Rear Cab Inner Braces

34-243 set of 3 47-55 \$109.95

Rear Cab Outer Cross Sill-belt line

34-245 47-55 \$119.95

Cab Rear Lower Panel

34-265-50 up to belt line—NO gas hole 47-55 \$664.95

Front Fenders-fender to rad support brace not included

34-221-47L left 47-53 \$749.95 Inquire

34-221-47R right 47-53 \$749.95 Inquire

34-221-47GL GMC w/ park light hole left 47-53 \$849.95 Inquire

34-221-47GR GMC w/park light hole right 47-53 \$849.95 Inquire

34-221-54L left 54-55 \$749.95 Inquire

34-221-54R right 54-55 \$749.95 Inquire

34-221-47L-B big truck w/ 18" wheels & up left 47-53 Inquire

34-221-47R-B big truck w/ 18" wheels & up right 47-53 Inquire

34-221-54L-B big truck w/ 18" wheels & up left 54-55 Inquire

34-221-54R-B big truck w/ 18" wheels & up right 54-55 Inquire

Bill's Truck Shop

Phone (905) 725-3460 / (905) 725-2022 / Fax (905) 404-2302 email: bill@billstruckshop.com

Sheet Metal Replacement Parts

Group 34

			<u>Year</u>	<u>New</u>	<u>Used</u>
	Cab Floor	-bare for custom trucks			
	34-206-A	w/out seat frame/tank support etc	47-55	\$899.00	
	Cab Floor -original style				
	34-206-B	w/ seat frame(loose)/tank support -correct for 49-55 w/ fuel tank in cab	47-55	\$1049.95	5
	Seat Frame Support	-ft & rear supports on cab floor -includes tank base w/ straps			
	34-206-S		47-55	\$299.95	\$250.00
	Cab Firewall	w/ front floor			
	34-209	w/o heater application holes	47-55	\$495.00	
	Dash Panel—OE 47-48 dash is not recessed for column shift lever as they were all floor shift				
	34-211-47	Chev/GMC 1st series	47-53	\$575.00	\$250.00
	34-211-54	Chev/GMC 1 st series	54-55		\$350.00
	34-211-55G	1st series GMC	55-55		\$350.00
	Support-dash to firewall				
	34-211-47S		47-53	\$71.00	
	34-211-47SK	hardware kit	47-53		
	Rear Fenders w/ upper inner support brace (pickup only)				
	34-230-L	left	47-55	\$749.95	Inquire
	34-230-R	right	47-55	\$749.95	Inquire
	Crown Brace-Rear Fender				
	34-230-CB	fits left or right	each	47-55	\$59.95
	Used parts pricing vary depending on condition				
	Rear Fender Front Lower @ running board				
	33-225-L	6" high	left	47-55	\$69.95
	33-225-R	6" high	right	47-55	\$69.95
	33-225-S	"L" reinforcement w/ rear fender patch @ running board pr		47-55	\$13.95

Bill's Truck Shop

Phone (905) 725-3460 / (905) 725-2022 / Fax (905) 404-2302 email: bill@billstruckshop.com

Sheet Metal Doors/Fenders

Group 34

34-247-RD



34-247-LD



12-207-47L

Doors-all doors empty shells only

		<u>Year</u>	<u>New</u>	<u>Used</u>
34-247-LD	w/ turn down handles w /o vent window L	47-50	\$799.95	Inquire
34-247-RD	w/ turn down handle w/o vent window R	47-50	\$799.95	Inquire
34-252-LD	w/ turn down handle & w/ vent window L	51-52	coming	Inquire
34-252-RD	w/ turn down handle & w /vent window R	51-52	coming	Inquire
34-253-LD	w/push button handle w/ vent window L	52-55	\$825.95	Inquire
34-253-RD	w/push button handle w/ vent window R	52-55	\$825.95	Inquire

Door Hinges

See section 12

Lower Door Access Panels (each)OE used has 1/4 hole for machine screw & 54-55 has hole for # 8 screw—all replacements are the 47-53 style

12-207-47L		left	47-55	\$66.95	\$50.00
12-207-47R		right	47-55	\$66.95	\$50.00
12-207-54L	has hole for # 8 screw	left	54-55		\$50.00
12-207-54R		right	54-55		\$50.00

Check our website www.billstruckshop.com for California trucks and parts

Bill's Truck Shop

Phone (905) 725-3460 / (905) 725-2022 / Fax (905) 404-2302 email: bill@billstruckshop.com

Sheet Metal Doors/Fenders

Group 34

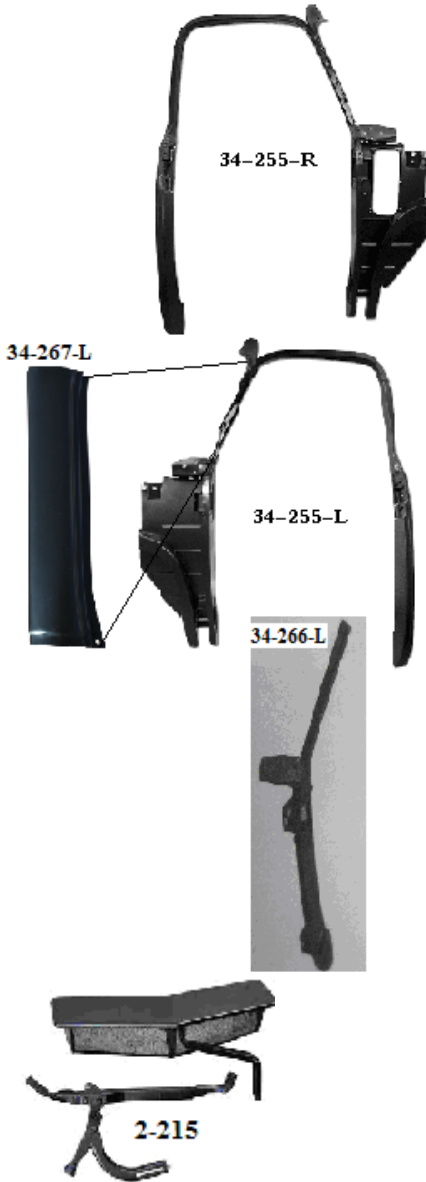

Outer Door Frame

			<u>Year</u>	<u>New</u>	<u>Used</u>
34-255-L	w/ inner @ inner to outer cowl panel	left	47-51	\$695.00	
34-255-R	w/inner @ inner to outer cowl panel	right	47-51	\$695.00	
34-255-52L	w/ inner @ inner to outer cowl panel	left	52-55	\$650.00	
34-255-52R	w/ inner @ inner to outer cowl panel	right	52-55	\$650.00	

Front Door "A" Pillar approx 51" tall

34-266-L	includes hinge pockets w/ coarse thread nut installed		47-55	\$269.95	
34-266-R	includes hinge pockets w/ coarse thread nut installed		47-55	\$269.95	

Pillar-outer "A" approx. 14" long

34-267-L		left	47-55	\$49.95	
34-267-R		right	47-55	\$49.95	

Top Cowl Vent assembly

2-215	call for used parts		47-53	\$219.95	\$100.00
2-215-54			54-55		\$125.00

Check our website www.billstruckshop.com for California trucks and parts

Bill's Truck Shop

Phone (905) 725-3460 / (905) 725-2022 / Fax (905) 404-2302 email: bill@billstruckshop.com

Sheet Metal REPLACEMENT PANELS

Group 34



34-245-3



34-246-3



34-251



34-252



34-250-47

Back View



34-260-47

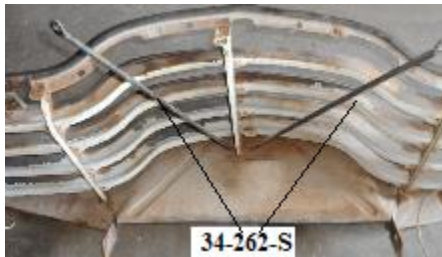

34-262-S



34-262



34-262-G

Cab- Inner Window /Roof Panel

		Year	New
34-245-1	w/ rear window only	47-55	inquire
34-245-3	w/ corner windows	47-55	\$499.00

Cab-Outer Window/Roof Panel

34-246-1	w/ rear window only	47-55	\$570.00
34-246-3	w/ corner window	47-55	\$575.00

Cab Roof

34-250-47		47-53	\$594.95
34-250-54		54-55	

Inner Roof Panel-front

34-251		47-53	\$109.95
--------	--	-------	----------

Windshield Centre Post Support

34-252	roof to dash –support for window seal & trim	47-53	\$14.95
--------	--	-------	---------

Cab Cowl Panel outer w/cowl vent opening

34-260-47		47-53	\$545.00
34-260-54		54-55	

Lower Splash Apron-supports inner fenders @ rad

34-262	Chev only	47-55	\$279.95
34-262-G	3 pc set GMC only	47-55	\$299.95

Inquire about separate GMC splash apron pcs

Supports-lower valance/grille-pair

34-262-S	Chev only	47-53	\$25.00
----------	-----------	-------	---------

All truck shipments will have a \$10.00 crating fee for materials

INQUIRE ABOUT SCRATCH AND DENT DISCOUNTS

Bill's Truck Shop

Phone (905) 725-3460 / (905) 725-2022 / Fax (905) 404-2302 email: bill@billstruckshop.com

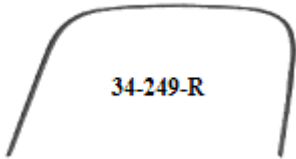

Used cab price can vary depending on condition
CAB w/ corner windows cab (5 window) can be ordered w/ many door combination—cab and doors are bare of working parts ---**INQUIRE** – used can be w/ or w/o corner window **Bare cab**

Year New Used

ONLY NEW CABS ARE PRICED IN AMERICAN \$

34-270-47	w/ turn handles w/ o vent window	47-50	Inquire	Inquire
34-270-51	w/ turn handles w/ vent window	51-51	Inquire	Inquire
34-270-52	w/ push handles-w/ vent window	52-53	Inquire	Inquire
34-270-54	w/ push handles-w/ vent window	54-55	Inquire	Inquire

Cab Drip Rail

34-249-L	left	47-55	\$83.95
34-249-R	right	47-55	\$83.95

Bill's Truck Shop

Phone (905) 725-3460 / (905) 725-2022 / Fax (905) 404-2302 email: bill@billstruckshop.com

CUSTOM REPAIR PANELS

Group 35



Firewall Cover 2 pcs

35-2001-A

pair

Year

47-54

New

\$225.00

Used

Upper Cowl Filler

35-2002

47-55

\$89.95

Kick Panels

35-2003

pair

47-55

\$200.00

Door Panels

35-2004

pair

47-55

Inquire

Toe Board

35-2005

2 pcs

47-55

\$269.05

Bill's Truck Shop

Phone (905) 725-3460 / (905) 725-2022 / Fax (905) 404-2302 email: bill@billstruckshop.com



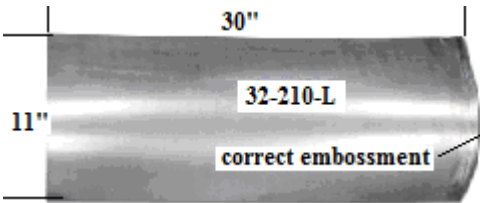

32-213-LR



32-213-RR



cab corner
filler
fender support

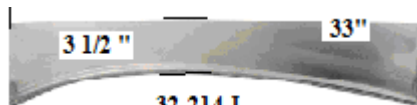

32-214-L

32-211-R



32-215-L



32-216

32-217

Quarter Panel Repair 30 " long x 10.5 high

	<u>Year</u>	<u>New</u>
32-210-L		
left	47-55	\$139.95
32-210-R		
right	47-55	\$139.95

Quarter Panel Fender Support Front—part of rear inner arch @ front of rear fender to body —cage nuts attached

32-211-L		
left	47-55	\$54.95
32-211-R		
right	47-55	\$54.95

Quarter Panel Corner w/ Support @ rear—includes section to attaches rear of rear fender to rear corner w/ cage nuts attached & corner filler

32-213-LR	3 pcs	approx. 13"		
left			47-55	\$224.95
32-213-RR	3 pcs	approx. 13"		
right			47-55	\$224.95

Rear Fender Arch 33 " long x 3 1/2" wide

32-214-L				
left			47-55	\$119.95
32-214-R				
right			47-55	\$119.95

Rear Fender Repair-front lower

32-215-L	lower 6 1/2 T x 10"long			
left			47-55	\$59.95
32-215-R	lower 6 1/2 T x 10"long			
right			47-55	\$59.95

Rear Valance Outer Edge @ rear door sill (tailpan) w/ rear barn doors 2 pcs

32-216		left &		
right/pr			47-55	\$139.95

Rear Valance replacement w/ rear barn doors 2 pcs (tailpan)

32-217		left &		
right/pr			47-55	\$159.95

Bill's Truck Shop

Phone (905) 725-3460 / (905) 725-2022 / Fax (905) 404-2302 email:

bill@billstruckshop.com

Suburban-Panel

Group 35

32-218-R



Rear Barn Door hinge 47-55 Inquire

Rear Fender---sub or panel **NEW**

32-218-L left 47-55 \$999.00

32-218-R right 47-55 \$999.00

Bill's Truck Shop

Phone (905) 725-3460 / (905) 725-2022 / Fax (905) 404-2302 email: bill@billstruckshop.com

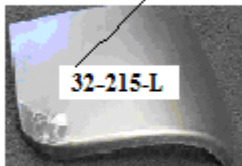
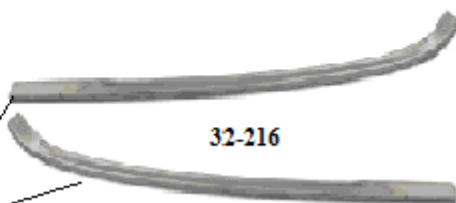
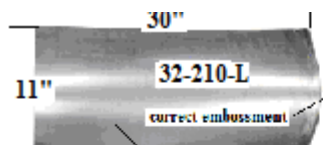

32-211-R



32-213-LR

Radio

Due to the fluctuation of the Canadian and American dollars call for current prices

Group 36



36-0205-S antenna
36-205-T windshield seal



hood-open position
1/2 gap
antenna gasket



36-209-S
36-209-G



36-212-54



36-207-47



36-207-50



36-207-47G



36-207-50G

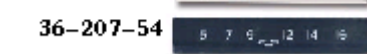

36-207-54



36-0207-54G



36-210-S



4-0211-ER



36-209-W

Telescopic Antenna w/ cable and hardware & instructions

36-205-T 47-55 \$154.95

If installing a new ant in the existing hole make sure it is in the correct location as it will only fit in the OE location-tight up to the window seal-need to save a square edge on the antenna gasket-see picture

Side Mount Antenna-universal w/ cable and hardware -stainless steel

36-0205-S dual stand side mount 36-59 \$49.95

36-0205-S1 single stand side mount 36-59 \$39.95

Radio Face Plate Tuning Indicator

36-207-47 plastic, Chevy, white letters w/tapered back case 47-49 \$23.95

36-207-50 plastic, Chevy, white letters w/ flat back on case 50-53 \$23.95

36-207-47G plastic, GMC, red letters w/ tapered back on case 47-49 \$23.95

36-207-50G plastic, GMC, red letters w/ flat back on case 50-53 \$23.95

36-207-54 glass, Chevy, white letters 54-55 \$23.95

36-0207-54G glass, GMC, white letters 54-59 \$23.95

Radio Face Bezel

36-212-54 Chev and GMC 54-55 \$39.95

Original Radio 6 volt Chev-GMC

36-209 47-49/50-53/54-55/ ALL Inquire

Radio Knob (Teardrop) Spacers between knob and dash - moulded maroon plastic

36-209-S pair 47-53 \$26.25

Radio Bezel Spacer Casket

36-209-G pair 47-53 \$2.75

Radio Speaker Sponge

36-210-S molded-around speaker opening 47-53 \$19.95

Voltage Reducer-for radio & heater motor

4-0211-ER 1 ohm 50 watt metal incised \$12.95

Radio Power Wire w/ fuse holder

36-209-W 2 wire cotton braded like original 47-53 \$34.95

Radio

Due to the fluctuation of the Canadian and American dollars call for current prices

Group 37



36-209-SL

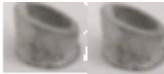

36-209-SU

36-209-SLH

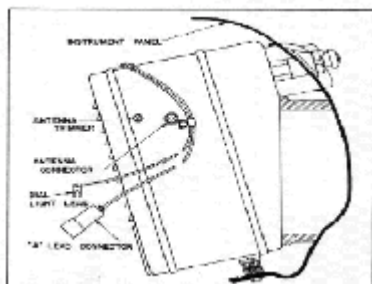

36-209-PB



36-209-DH

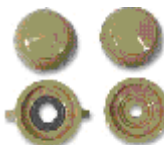

36-209-TV



36-209-54TV



GMC

Radio Spacer

36-209-SU upper -fits over tuning shafts between dash and case pair 47-53 \$7.95

36-209-SL lower - support radio @ base pair 47-53 \$7.95

Radio Mount Hdw 2 screws w/ washers

36-209-SLH secures radio to lower dash 47-53 \$1.50

Radio Dial Housing

36-209-DH plastic maroon 47-53 \$2.95

Radio Pushbutton & Tuning knobs

36-209-PB tan- push button controls 5pcs 47-53 \$23.95

36-209-TV tan- tuning-volume controls-4 pcs 47-53 \$25.95

36-209-54TV black- tuning-volume controls-4pcs 54-55 \$35.95

36-209-54GTV GMC grey-tuning-volume controls-4pcs 54-55 \$35.95

ORIGINAL RADIOS

Inquire

Bill's Truck Shop

Phone (905) 725-3460 / (905) 725-2022 / Fax (905) 404-2302 email: bill@billstruckshop.com

Radio

Due to the fluctuation of the Canadian and American dollars call for current prices

Group 37



Dual Voice Cone Speaker -one speaker w/ dual tweeters to provide 140 watts in the original speaker location- w/ brackets			
36-2013-DVC	140 watts	47-53	\$99.95
Kick panel Speaker set -Plastic panels w/moulded speaker (4 " 2 way 60 watt speakers)-pair			
36-220-KP		47-55	\$189.95
36-220	assembly w/o speakers	47-55	\$109.95
Radio-AM/FM – new 12V ,electronic shafts, aux inputs for iPod,MP3,DVD,Satellite, seek & scan, digital clock,200 watts w/ chrome bezel & CHEV logo-fits original location w/o any modification- w/ Chev logo			
36-2USA-2		47-53	\$249.95
36-2USA-2-GMC		47-53	\$249.95
36-2USA-6	same as above w/ 240 watts & CD change controller	47-53	\$349.95
36-2USA-7	AM-FM Radio -w/bluetooth		\$499.95
Radio-AM/FM – new 12V ,electronic shafts, aux inputs for iPod,MP3,DVD,Satellite, seek & scan, digital clock,200 watts w/ chrome bezel & CHEV logo-fits original location w/o any modification- Chev USA 740 W/ BLUETOOTH			
		47-53	\$449.95
Volt Booster -will operate 12 volt negative ground accessories from 6 or 8 volt negative ground electrical systems. The maximum output power is a function of input voltage. When used in a 6 volt system, it can continuously supply more than 3-1/2 amps with the engine off, and about 5 amps with the engine running at a fast idle. Because of its very efficient design, its current draw is negligible when no load is applied (10 milliamps). NOT RECOMMENDED FOR: Power actuated door locks, trunk release solenoids, air conditioner clutches, fans, blowers, power windows, or other electromechanical devices.			
36-00VB			\$89.95
Amplified Electronic AM/FM Hidden Antenna—requires 12 volt-includes 80" cable- peel- stick application			
5-0HAN		universal	\$49.95
Condenser---Radio(noise) Suppresion Condenser			
5-00RC	when using point ignition		\$19.95

Bill's Truck Shop

Phone (905) 725-3460 / (905) 725-2022 / Fax (905) 404-2302 email: bill@billstruckshop.com

Brakes

Due to the fluctuation of the Canadian and American dollars call for current prices

Group 37



37-201-FR

37-0202-F



37-0330

37-0203-FL



37-203-F

37-0208-R

37-0325

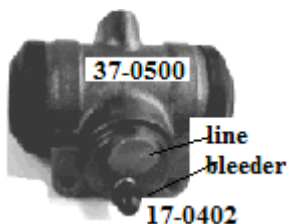

37-0500

17-0402

Brake Shoes (per axle) bonded shoes unless noted		
37-0201-FR-P front or rear shoes set of 4 w /huck style brakes-adjusters on wheel cylinders-bonded premium grade -non-asbestos w/FF (C.F) coefficient of friction 11 x 1 3/4	36-50	\$109.95
37-201-FR front or rear shoes set of 4 w /huck style brakes-adjusters on wheel cylinders - service grade / bonded 11 x 1 3/4	36-50	\$69.95
37-0202-F 1/2 ton front shoes 2" set of 4	51-62	\$49.95
37-0202-F/P premium brand-riveted lining set 2"	51-62	\$74.95
37-0202-R 1/2 ton rear shoes 1 3/4 set of 4	51-62	Inquire
37-0330 53-59 front & rear-64-70 rear 3/4 ton Brake shoe set- 12 x 2 set of 4	51-59	\$79.95
37-0014 14 x 2 1/2 -set of 4 46-52 1 ton rear & 46-52 1 1/2 front relined/bonded-huck style	53-70	\$79.95
37-0012 12 x2 set of 4 46-52 1 ton rear & 46-52 1 & 1 1/2 front relined/bonded-huck style	46-51	\$225.00
37-0204 14 x 2 1/2 rear set of 4 1 ton	46-52	\$195.00
	53-59	Inquire
Inquire about other applications		
We provide brake shoe relining on all large size brake shoes - approx priced per shoe \$		Inquire
Wheel Cylinder (each) brake lines exit to front		
37-203-F w/adjuster on cyl-36-50 1/2 ton-37-52 3/4 ton---37-42 1 ton---36-50 1 1/2 ton-47-50 2 ton 1/1/4 dia L or R front - each Huck style	36-52	\$69.95
37-203-R w/adjuster on cyl - rear L or R 36-50 1/2 36-45 3/4 ton Huck style 1 3/16 cup size	36-50	\$119.95
37-0358 w/adjuster on cyl -rear L or R 37-45 w/ 14' brakes,46-52 3/4 rear L or R & 46-52 1 ton front 1 3/8 cup	37-52	Inquire
37-0203-FL front left 1/2 ton 1 1/8 cup	51-59	\$39.95
37-0204-FR front right 1/2 ton 1 1/8 cup	51-59	\$39.95
37-204-R 1/2 rear L or R 1 " cup	51-55	\$59.95
37-0209 3/4 front L or R 1.125 cup	53-59	\$99.95
37-203-1R 3/4 rear L or R	47-52	\$69.95
37-0209 3/4 rear L or R 1 1/4cup	53-59	\$99.95
37-0325 1 ton w 14 x 2 1/2 shoes/ huck style brakes - cast housing & adjuster 1 3/8 cup -fits L & R	46-52	\$179.95
37-0358 1 ton front L or R 1 3/8 bore	46-52	\$69.00
37-0209 1 ton front L or R 1 1/4 cup	53-59	\$97.95
37-203-3R 37-52 3/4 ton rear L or R- 1ton 46-52 ft or rear 1 3/8 cup size w/ huck style brakes	47-52	\$89.95
37-0209 1 ton rear L or R 1 1/4 cup	53-59	\$99.95
37-0208-R 1 1/2 -2 ton rear 1/ 1/2 dia -Huck style each	36-50	\$155.00
37-0499 rear cylinder or rear w/ dual cylinder 1 1/2- 2 ton Chev & GMC fit L or R each	53-59	\$155.00
37-0500 front cylinder or rear w/ dual cylinder 1 1/2- 2 ton Chev & GMC fit L and R each	53-59	\$155.00

Bill's Truck Shop

Phone (905) 725-3460 / (905) 725-2022 / Fax (905) 404-2302 email: bill@billstruckshop.com

Brakes

Due to the fluctuation of the Canadian and American dollars call for current prices

Group 37



37-0204-3/16



37-0054

37-0038



37-0050



17-0402



37-0051

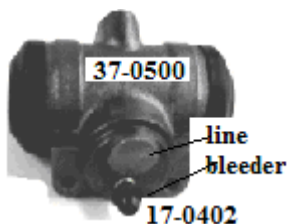

37-0500

line
bleeder

17-0402



45-0134



37-0245

37-0829

Wheel Cylinder Overhaul kits- includes cups, springs & adjusters

37-0204-3/16	1 3/16 w/ huck style brakes 1936-1950 1/2 ton, 1936-1945 3/4 ton with smaller 11 inch brakes. "rear"	36-50	\$29.95
37-0204-1/4	1 1/4 w huck style brakes-1936-1950 1/2 ton and 1936-1952 3/4, 1, 1 1/2, and 2 ton."front"	36-52	\$33.00
17-0036	1 1/8 " bore		\$20.95
17-0046	1 " bore		\$11.95
37-0054	1 1/4 " bore		\$24.95
37-0038	1 3/8 bore (1.375)		\$36.95
37-0036	1 3/16 bore		29.95

Wheel Cylinder Cups

37-0124	1 1/8 cup size	each	\$1.75
37-0138	1 3/8 cup size---	each	\$1.75
37-0125	1 1/4 cup size	each	\$3.95

Wheel Cylinder Push Rod

37-0050		each	51-72	\$6.95
---------	--	------	-------	--------

Bleeder Screw

17-0402	3/8 head 3/8 x 24	each	47-72	\$1.69
---------	-------------------	------	-------	--------

Brake Shoe Guide Plate

37-0051	1/2 & 3/4	each	51-87	\$9.95
---------	-----------	------	-------	--------

Hydraulic Brake Light Switch

45-0134	w/ adaptors & 3/16 line fittings & adaptors--closed circuit @ 45PSI			\$32.95
45-0134-S	switch only			\$18.60

Master Cylinder line adaptor

37-0829	5/16 inverted male w/ 1/4 female includes brass washer & 3/16 & 1/4 line fitting			\$7.95
---------	--	--	--	--------

Washer-master cylinder adaptor

37-0245	3/4 OD-.1/2 IN			\$2.25
---------	----------------	--	--	--------

Brake Booster & PCV Hose

36-0PCH	3/8 x 40" w/ clamps			\$24.95
---------	---------------------	--	--	---------

Power Brake Booster -remote type

37-2BB	rebuild service w/ old core-used on large trucks-frame mounted	47-55	Inquire	
--------	--	-------	---------	--

Bill's Truck Shop

Phone (905) 725-3460 / (905) 725-2022 / Fax (905) 404-2302 email: bill@billstruckshop.com

Brakes

Due to the fluctuation of the Canadian and American dollars call for current prices

Group 37



37-205-47
37-205-47 37-205-51 37-205-52



37-0211



37-0003



17-0505

1/2" fitting 9/16" fitting



37-2MCA



17-5246

Year New Used

Master Cylinder

37-205-47	1/2 ton w/ 1 7/16 end cap fitting w/ direct brake line fitting 1" bore	47-50	\$149.95
37-205-51	1/2 ton w/ 1 1/2 end cap w/ direct line application 1 1/8" bore	51-51	\$205.95
37-205-52	1/2 ton w/ 1 1/2 end cap w/ block fitting application 1 1/8 bore	52-55	\$179.95
Master cyl # 37-205-52 can use on all above w/ correct adapter for lines 1 1/8 bore			
37-206-7	48-51 3/4T--47-52 1 T--47-55 1 1/2 T & 2-2 1/2T - w/ direct brake line fitting 1 1/4 bore	47-55	\$239.95

Adaptor-master cylinder push rod to pedal arm

37-0028	clevis w/ hdw 3/8 NF		\$8.50
---------	----------------------	--	--------

Master Cylinder Rebuild Kit

37-0003	1 bore	36-51	\$39.95
37-0146	1 1/8 bore	51-59	\$48.95
37-0033	1 1/4 bore -3/4 & 1 ton	36-52	\$49.95

Master Cylinder Boot

10-0504-MB	w/ manual brakes	47-72	\$6.00
------------	------------------	-------	--------

Master Cylinder Fill Cap

37-0211	1 1/4 OE metal w/gasket	40-59	\$34.95
37-0211-A	1 1/4-plastic w/ gasket	40-59	\$19.95
37-0211-B	1 9/16	47-59	

Master Cylinder Adapter kit- a great upgrade to dual master for -includes hardware & instruction-if pedal shaft bushing are worn they MUST be replaced

37-2MCA		47-54	\$199.95
---------	--	-------	----------

Master Cylinder – new 1" bore dual master for adapter kit

17-0505	w/ drum brakes –see next page for brake line fittings confirm your pipe size		\$99.95
---------	---	--	---------

17-5246	master cylinder 1 1/8 (1.125)bore & deep bush rod for 3/4 ton up trucks when converting to dual master		\$159.95
---------	--	--	----------



Bill's Truck Shop

Phone (905) 725-3460 / (905) 725-2022 / Fax (905) 404-2302 email: bill@billstruckshop.com

Brakes

Due to the fluctuation of the Canadian and American dollars call for current prices

Group 37

		<u>Year</u>	<u>New</u>	<u>Used</u>
	Harness-proportioning valve switch			
37-0759	17-0PVK-H replacement harness w/ socket		\$19.95	
	Master Cylinder w/ prop valve & bracket-when installing updated master under cab w/booster			
37-0759-B	37-0759 disc- drum prop valve w/ lines & bracket	47-59	\$239.95	
	37-0760 disc- disc prop valve w/ lines & bracket	47-59	\$239.95	
	Bracket kit w/o master cylinder			
	37-0759-B includes disc-drum valve,,lines,harness	47-59	\$144.95	
	Prop valve rear fitting			
17-0038	17-0038 --Fitting--9/16-18 inverted male to 3/8-24 female		\$6.95	
17-0016	17-0016 Fitting--9/16-18 inverted male to 7/16-24 female		\$6.95	
17-0020	17-0020 Fitting--9/16-18 inverted male to 1/2-20 female		\$6.95	
	Universal brake booster			
	45-0DD8 8" dual diaphragm zinc plated		\$169.95	

Bill's Truck Shop

Phone (905) 725-3460 / (905) 725-2022 / Fax (905) 404-2302 email: bill@billstruckshop.com

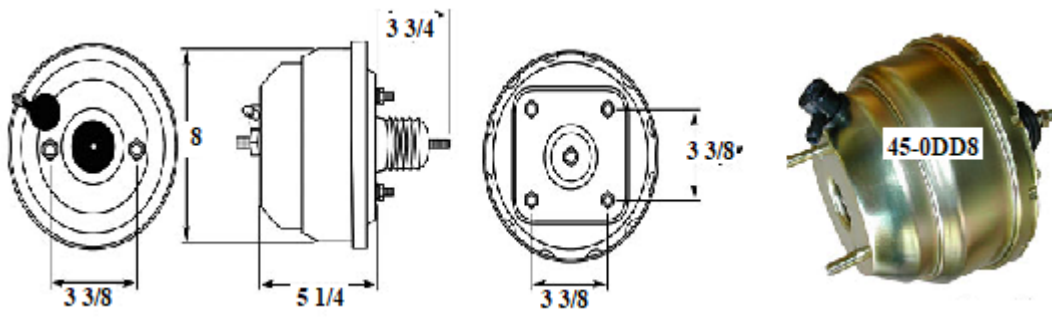

Brakes

Due to the fluctuation of the Canadian and American dollars call for current prices

Group 37

		<u>Year</u>	<u>New</u>	<u>Used</u>
<p>37-210</p> <p>41-0215</p> <p>41-0215-1</p> <p>41-0218-F</p> <p>41-0215-2</p> <p>41-0214</p>	Brake Pedal Return Spring w/ 12" extension			
	37-210 @ master cylinder	47-55	\$16.95	
	Clutch Pedal Return Spring @ clutch offset rod			
	41-0214	47-59	\$5.95	
	Clutch Linkage Rod @ pedal arm			
	41-0215	47-59	\$17.95	
	Clutch Linkage Offset Adjust Rod @ fork			
	41-0215-1	47-59	\$27.95	
	Nuts-Jam nut for clutch adjust rod-pr			
	41-0215-2 pair of adjusting nuts w/ washers	47-59	\$3.50	

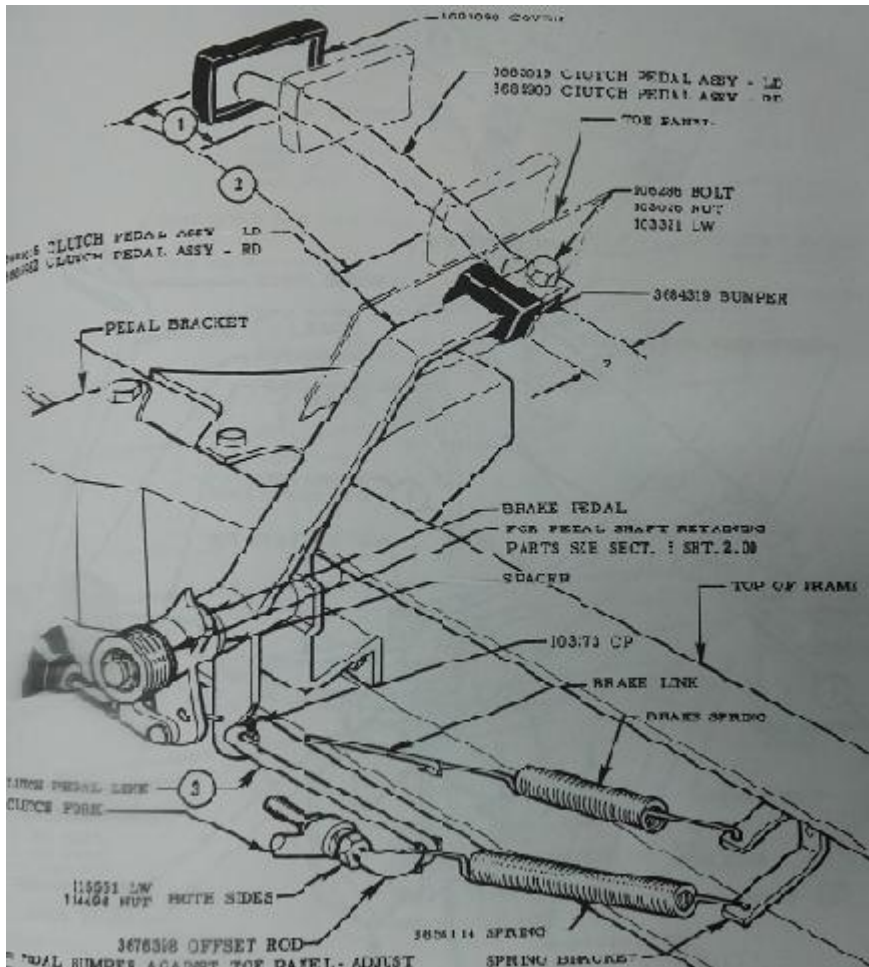

Brakes

Due to the fluctuation of the Canadian and American dollars call for current prices

Group 37

37-0243



37-0594



37-0248



37-0471

Brake Hose Gasket 7/16 ID

			Year	New	Used
37-0243	7/16	each		\$1.25	
37-0795	3/8 ID	each		\$1.25	

Brake Line Division Block

37-0247	brake line "T" on R frame rail-secured w/ nut		51-57	\$33.95	\$15.00
---------	---	--	-------	---------	---------

Rear Axle Division block

37-0248	38-70 Rear flex hose splitter block- secures to diff housing bracket w/ clip - flex line 7/16-20 on one side and 3/8-24 on the other 2 sides NOT 53 & 54		38-70	\$29.95	\$15.00
37-0249	Rear axle block fitting 1/4 line		36-65	\$34.95	

Wheel Cylinder Block- @ rear wheel cylinders between lines-use original bolt to secure

37-0203-B	36-50 1/2---51-53 3/4 to 2 ton---60-63 3/4 to 1 ton	each	36-50	\$27.95	\$10.00
-----------	---	------	-------	---------	---------

Wheel Cylinder Block Bolt

37-0203-BB	includes 2 brass washers		36-50	\$17.95	\$10.00
------------	--------------------------	--	-------	---------	---------

Brake Fitting-oversize

37-03025	(blue) 1/4 pipe-9/16 dia-18 threads per inch			\$3.50	
37-03026	(gold) 1/4 pipe-1/2 dia-20 threads per inch			\$3.50	
37-03023	(green) 3/16 pipe-1/2 dia-20 threads per inch			\$2.00	
37-03024	(olive) 3/16 pipe 9/16-18 threads per inch			\$3.50	

Plug Fitting

37-0594	1/4 brass plug -C360 inverted flare			\$1.98	
37-0595	5/16 brass plug--C360 inverted flare				

Tube Nut

37-0013	1/4 tube nut inverted flare-7/16 thread x 24 threads per inch			\$0.50	
37-0010	3/16 tube nut inverted flare-3/8 thread x 24 threads per inch 7/16 socket			\$0.50	
37-0000	3/16 tube nut inverted flare-3/8 thread x 24 threads per inch 3/8 socket			\$0.50	

Rear Axle Division block

37-0248	secures to diff housing bracket w/ clip to split (3/16) brake lines 1/2 ton NOT 53 & 54		51-66	\$27.95	\$15.00
---------	---	--	-------	---------	---------

Division Block w/ mount bracket (universal)

37-0476	3/16 tube 3/8-24 thread			\$29.95	
37-0471	"T" fitting 3/8-24 3/16 lines	each		\$6.99	

Bill's Truck Shop

Phone (905) 725-3460 / (905) 725-2022 / Fax (905) 404-2302 email: bill@billstruckshop.com

Brakes

Due to the fluctuation of the Canadian and American dollars call for current prices

Group 37

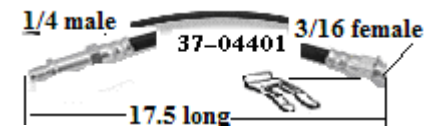
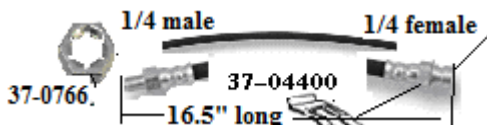

Brake Hose (each) 47-50 has 1/4 pipe /51-55 3/16 pipe fitting-----all hoses approx. 17" long
04401 requires nut to secure to frame

		Year	New	Used
37-04400	1/4 line- 1/2 ton front-each	47-50	\$24.95	
37-04401	3/16 line - 1/2 ton front-rear-each	37-55	\$36.95	
37-04400	1/4 line- 1 ton front-each	47-52	\$24.95	
37-04401	3/16 line- 1/2-3/4 ton-1 ton front-each	53-55	\$36.95	
37-04400	1/4 line 1/2 ton rear -each	47-55	\$24.95	
37-04400	1/4 line 3/4 ton rear-each	47-55	\$24.95	

Hose ID- #04401 extended @ wheel cylinder end w/ "U" clip to secure /// use 04400 "U" clip to secure

Brake Hose Lock Nut

37-0766	secures hose # 04402 to frame	47-59	\$1.25	
---------	-------------------------------	-------	--------	--

Brake Hose Gasket 7/16 ID

37-0243	brass seal & cylinder	each	36-87	\$1.25
---------	-----------------------	------	-------	--------

Brake Hose Clips

37-0215-C		each		\$1.65
-----------	--	------	--	--------

Brake Line Division Block

37-0247	brake line "T" on R frame rail-secured w/ nut	51-57	\$33.95	\$15.00
---------	---	-------	---------	---------

Rear Axle Division block

37-0248	secures to diff housing bracket w/ clip to split (3/16) brake lines 1/2 ton NOT 53 & 54	51-66	\$27.95	
---------	---	-------	---------	--

Wheel Cylinder Block- @ rear wheel cylinders between lines-use original bolt to secure

37-0203-B	36-50 1/2---51-53 3/4 to 2 ton---60-63 3/4 to 1 ton	each	36-50	\$23.95	\$10.00
-----------	---	------	-------	---------	---------

Wheel Cylinder Block Bolt

37-0203-BB	includes 2 brass washers	36-50	\$6.95	
------------	--------------------------	-------	--------	--

Brake Fitting-oversize

37-03025	(blue) 1/4 pipe-9/16 dia-18 threads per inch	\$3.50		
37-03026	(gold) 1/4 pipe-1/2 dia-20 threads per inch	\$3.50		
37-03023	(green) 3/16 pipe-1/2 dia-20 threads per inch	\$2.00		
37-03024	(olive) 3/16 pipe 9/16-18 threads per inch	\$3.50		

Clamp-insulated

37-0315	3/8 w/ hdw	pair	\$3.75	
---------	------------	------	--------	--

Bill's Truck Shop

Phone (905) 725-3460 / (905) 725-2022 / Fax (905) 404-2302 email: bill@billstruckshop.com

Brakes

HUCK BRAKE S

Group 38



Retainer/clip-stud lock-fits cars and trucks

				<u>NEW</u>	<u>USED</u>
37-0200-S	small-approx 7/16 ID	each	36-50	\$2.25	
37-0200-L	large - approx. 9/16 ID	each	36-50	\$2.25	
37-0200-1L	big truck approx 11/16 ID				\$3.00
37-02SL	kit 4 large and 2 small (6 pcs)				
does 1 axle			36-50	\$12.95	

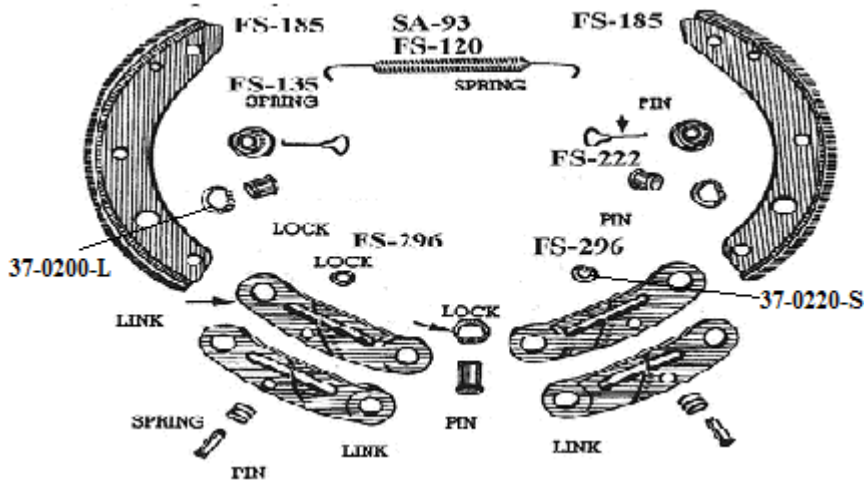

Brakes

Due to the fluctuation of the Canadian and American dollars call for current prices

Group 38



		Year	New	Used
Brake Shoe Return Spring				
38-0201-FR	½ ton front & rear-each	36-50	\$5.95	
38-0201-FR	¾ ton front each	37-52	\$4.95	
38-0202-FR	46-52 ¾ rear & 36-52 1 - 1 ½ & 2 ton front and rear	5/8 inch x 7 9/16 each	36-52	\$221.95
Brake Shoe Hold-Down Spring (each wheel)				
38-204	½ Ton, Ft. or R, pair	36-50	\$8.95	
38-0138	¾ ton up -w/ 2 ¾ pin 12" shoes and up/ ft and rear per axle	51-87	\$12.95	
Brake Spring Kit -hold down & return per axle				
38-0206-FR	front & rear axle 1/2 ton	51-63	\$18.95	
Brake Adjuster Screw w/o self adjusting brakes				
38-0208	fits L or R front & rear	each	51-62	\$16.95
Backing Plate Adjuster plug				
38-0250	ft or rear	each	36-87	\$0.85
Parking Brake Cable.				
38-210-OEWR	original style -wire wrapped- ½ ton-47-51 requires reusing original brake arm cable adaptors-or new -#17-0210-C	47-55	\$89.95	
38-210-OE	original style -rubber wrapped ½ ton-47-51 requires reusing original brake arm cable adaptors-or new -#17-0210-C	47-55	\$44.95	
38-210-3-----	47-55 Chev ¾ & 47-55 GMC long step ½ approx 49" long w/ inline grease fitting	47-55	\$89.95	
38-210-4	rear brake cable 1 ton up- w /huck style brakes-total cable 64"-casing 24" threaded rod 6" long----- special order	47-55	\$125.00	
Connector-park brake cable				
17-0210-C	w/ huck style brakes	each	36-50	\$13.95 \$5.00
38-210-N	-Rear brake cable- when replacing w/ new car style rear end original style lock on frame bracket (bracket hole must be drilled to ½") w/ clip style for round hole on backing plate -total cable 2" longer/threaded rod 2" longer see picture	47-55	\$145.00	

Bill's Truck Shop

Phone (905) 725-3460 / (905) 725-2022 / Fax (905) 404-2302 email: bill@billstruckshop.com

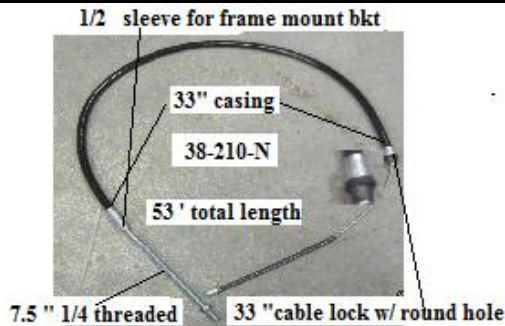

Brakes

Due to the fluctuation of the Canadian and American dollars call for current prices

Group 38



37-230-R

-remove bolt & close to 1/16 gap-drill hole to 9/16"
-casing 30 1/2" -total cable length 45"



Parking Brake Cable Frame Support-inquire by year and GVW of truck

			<u>Year</u>	<u>New</u>	<u>Used</u>
37-230-L	front support on frame	left 1/2 ton	47-55		\$40.00
37-230-R	front support on frame	right 1/2 ton	47-55		\$40.00

Brake Cable Yoke Ends

37-0027	2 1/2" long w/ pin	each	5/16 NF	47-55	\$14.95
38-222-4	4" long w/ hdw	5/16 NF for			
	long bed trucks	1/2 / 3/4 & 1 ton	each	47-55	\$24.95
7-204-C	curved end			47-55	\$16.95

Pin-cable yoke end w/ cotter pin

38-0435	5/16 x 1 1/4			47-55	\$1.45
---------	--------------	--	--	-------	--------

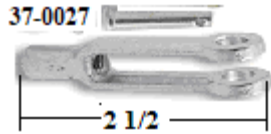
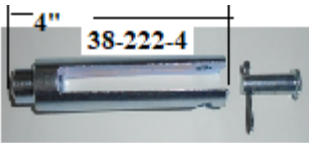

Parking Brake Cable Boot

37-0214		each		47-59	\$3.75
---------	--	------	--	-------	--------

Gaskets-Parking brake cable backing plate

38-216-G		pair		47-55	\$4.50
----------	--	------	--	-------	--------

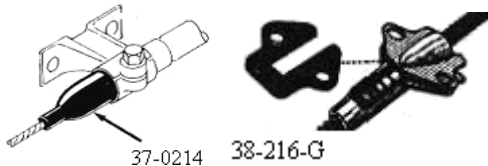

Bill's Truck Shop

Phone (905) 725-3460 / (905) 725-2022 / Fax (905) 404-2302 email: bill@billstruckshop.com

Brakes

Due to the fluctuation of the Canadian and American dollars call for current prices

Group 38



Brake Drum (each)

			<u>Year</u>	<u>New</u>	<u>Used</u>
37-0215	front brake drum 1/2 ton w/ huck style brakes- each		41-50	\$209.95	\$100.00
37-0216	rear brake drum 1/2 ton- w/ huck style brakes each	36-50 1/2 & 37-42 3/4	36-50	\$199.95	\$75.00
37-0217	front or rear	11x2" each	51-70	\$79.95	\$30.00
37-0200	front brake drum	12 x 2 3/4 and 1 ton	53-62	\$169.95	

Fits 64-75 1/2-3/4 ton rear 2 and 4 wheel drive, 64 1/2 ton 2 wheel drive front, and 65-75 1/2 ton 2 and 4 wheel drive front.-can use to upgrade to self adjusting brakes from 51-63

17-0508	Brake Adjuster kit w/ 11 brakes	L side	64-75	\$29.95	
17-0509	Brake Adjuster kit w/ 11 brakes	R side	64-75	\$29.95	
17-0444	Park brake arm retainer clip w/ tension washer	2 pair /both sides	60-91	\$3.00	
17-0444-SK	Stud- park brake arm to shoe	2 pins w/hdw		\$9.95	
These park arms used the stud w/ C clip to secure to the shoe (not the bolt w/nut)					
17-0701	Park brake cable arm-left	1/2 ton	64-91	\$29.95	
17-0702	Park brake cable arm-right	1/2 ton	64-91	\$29.95	

Park Brake Bar

37-0745	51-77 Strut-park brake	1/2-ton approx 7 1/2 long w/ 11 brakes	51-77	\$11.95	
---------	------------------------	--	-------	---------	--

Park Brake Bar Spring

37-0744	@ cross bar & front shoe	each	51-87	\$3.75	
---------	--------------------------	------	-------	--------	--

Adjuster arm Spring

17-0507		each		\$1.50	
---------	--	------	--	--------	--

Bill's Truck Shop

Phone (905) 725-3460 / (905) 725-2022 / Fax (905) 404-2302 email: bill@billstruckshop.com

Brakes

Due to the fluctuation of the Canadian and American dollars call for current prices

Group 38

	<u>Year</u>	<u>New</u>	<u>Used</u>
Parking Brake Kit Everything need to install a NEW style push peddle park brake w/ OE or replacement rear end-includes pedal assembly, ft & 2 rear cables, ft cable support and threaded rod w/ joints to rear cable cross support			
38-2200-K	47-55	\$359.95	
Park Brake Handle Spring w/hand brake 38-0219-HS with brake @ trans			
	29-59	\$13.95	
Brake Cable Support 17-0001 11 gauge galvanized steel-can be used to anchor park cables on frame-bend support to each application-9/16 cable hole-may require enlarging/includes hdw-bend bkt to fit application			
		\$18.95	



38-0219-HS

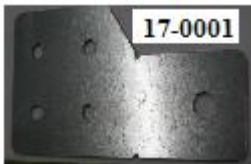

17-0001

Bill's Truck Shop

Phone (905) 725-3460 / (905) 725-2022 / Fax (905) 404-2302 email: bill@billstruckshop.com



38-2200-K

Chassis

Due to the fluctuation of the Canadian and American dollars call for current prices

Group 38



Wheel Studs

38-230-S	7/16-20	each	47-50	\$3.25
38-0230-S	7/16-20 X 1 3/8	each	51-70	\$3.99

Wheel Nut

38-0230-N	7/16-20	each	36-70	\$3.50
38-0144	7/16-20 13/16-1 3/8 deep/chrome	each		\$2.25

Spindle Nut and Washer

15-0193	1/2 ton	each	41-87	\$14.95
15-0193-1	3/4 ton up	each	41-up	\$10.00
15-0193-2	2 ton up-screw on cap	each		\$10.00

Spindle Dust Cap

17-0977	approx 2 3/32 " OD	1/2 ton & some 3/4 ton check dia	each	47-62	\$9.95
17-0977-1		1 ton up			\$5.00

Spindle

38-230-L	1/2 or 3/4 ton		47-55	\$100.00
38-230-R	1/2 or 3/4 ton		47-55	\$100.00

Wheel Bearings Hubs

38-320-H	1/2 or 3/4 ton		55-59	\$50.00
----------	----------------	--	-------	---------

Wheel Bearings w/race-front-please order all parts after checking # stamped on parts

38-0325 -I	inner wheel bearing- ball type-	1/2 ton	38-59	\$98.00	\$20.00
38-0325-O	outer wheel bearing-ball type-	1/2 ton	38-61	\$79.95	\$20.00
38-0325-6I	inner wheel bearing- ball type-	3/4 & 1 ton	36-52	Inquire	\$75.00
38-0325-6O	outer wheel bearing-ball type	3/4 & 1 ton	36-52	Inquire	\$75.00
38-0325-3I	inner wheel bearing- ball type-	3/4 & 1 ton	53-59	Inquire	\$75.00
38-0325-3O	outer wheel bearing-ball type	3/4 & 1 ton	53-59	Inquire	\$75.00

Wheel Bearing Kit-upgrades to tapered roller bearings and includes seals- 1/2 ton

38-04759-BK			47-59	\$199.95
38-04759-S				

Grease seal -replacement for bearing kit	each	47-59	\$13.95
---	------	-------	---------

Dust Shield for inner seal & bearing

38-0303	tin shield @ spindle backing plate	each	47-62	\$3.00
---------	------------------------------------	------	-------	--------

Grease Seal-front

38-0326	1/2 ton 2 wh drive	each	38-59	\$15.95
38-0669	3/4, 1 and 1-1/2 ton	each	35-59	\$27.95

Bill's Truck Shop

Phone (905) 725-3460 / (905) 725-2022 / Fax (905) 404-2302 email: bill@billstruckshop.com

Suspension

Due to the fluctuation of the Canadian and American dollars call for current prices

Group 39



Shackle Kit Threaded Pins, bushings, side plates, seals and all mounting hardware

		<u>Year</u>	<u>New</u>	<u>Used</u>
39-201F	1/2 ton - 3/4 ton, front w/ 1 3/4" spring	47-55	\$69.95	
39-301-FR	40--55 1-, 1 1/2-, 2 ton front & 55-59 -1/2-, 3/4 ton w/2 " spring front and rear 2 1/8" eye to eye	40-57	\$74.95	
39-201R	1/2 ton, rear w 1 3/4" spring	34-55	\$89.95	
39-202R	3/4 - 1 ton, rear-pins & bushing -w/ cast shackle 2 pins w/ bushings per side	47-55	\$109.95	

Rear Spring Shackle Support

39-0203-S	cast iron support w/ new bushing- 33-68 3/4 - 1 ton and 33-59 1 1/2 - 2 ton ---w 2 1/2" wide spring each	33-68	\$124.95	\$50.00
-----------	--	-------	----------	---------

Shackle Supports on frame

39-202	front or rear—left or right each	47-55		\$75.00
--------	----------------------------------	-------	--	---------

Spring Eye Bolt & Bushing @ fixed end of spring

39-204-FR	front 1/2 & 3/4-rear 1/2 ton w 1 3/4" spring each	34-55	\$39.95	
39-205-F	1 & 1 1/2 ton w/ 2" spring -grease fitting on nut end each	41-55	\$69.95	
39-205-R	rear 3/4 - 1 ton w/ 2" spring-grease fitting on thread end w/ lock pin each	37-55	\$59.95	

Tapered Lock Pin w/nut

39-0205-P		47-59	\$15.95	\$5.00
-----------	--	-------	---------	--------

Shackle Rubber Seals (each)

39-0206		34-66	\$1.15	
---------	--	-------	--------	--

King Pin Set -pins, bushings, shims, end caps, & lock pins

OS. 010 oversize /STD standard size (check before order)
OS is to compensate for "I" beam

39-208-53OS	.910 shaft dia. 5.312 / .010 over size pin 1/2 ton	41-55	\$139.95	
39-208-53ST	.866 X 5.312 pin 1/2 ton & 41-45 3/4 & 1 ton	41-55	\$149.95	
39-208-1-47ST	0.921 pin OD 46-52 3/4 - 1 ton & 41-50 1 ton	46-52	\$199.95	
39-208-1-53ST	3/4 & 1 ton	53-55	\$199.95	
39-0208-41OS	41-50 1 1/2, 46-52 3/4, 1 ton	41-52	\$115.00	

Grease/Zerk Fittings

39-0225	1/8-28 Pipe thread 45 degree-each		\$2.10	
39-0225	1/8-28 Pipe thread-straight---each		\$2.10	
39-0221	1/4 -28 Pipe thread-straight---each		\$1.00	

Bill's Truck Shop

Phone (905) 725-3460 / (905) 725-2022 / Fax (905) 404-2302 email: bill@billstruckshop.com

Suspension

Due to the fluctuation of the Canadian and American dollars call for current prices

Group 39

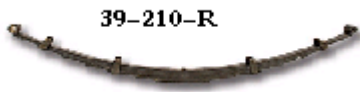

39-210-R



39-210M-R



39-210M-F



39-210M-F

39-210A-F



39-0004-FR

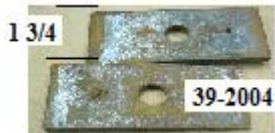

39-2004



39-0211



Alignment Solution for Installing a Late Model Rear End in a 1947-1954 Pick Up
 On the original rear end, the spring centerbolt is offset to the front of the spring by 2" to 3". If you install a modern rear end (with an open driveshaft) and retain the original springs, the wheels will end up offset forward (inside) of the original wheel openings in the fenders. To correct this problem, remove the original springs and reverse them end to end (front to back) as they are the same on both ends. This will bring the spring centerbolt to the rear of the axle and place the new rear end in the center of the fender wheel openings.

Want to lower your truck

-remove leaves to 7 on front and 7-8 on rear and use the (1") shorter ft shackles on rear -an inexpensive way to lower the overall height of the truck by 2 to 3 "

Main Leaf Spring-replace the main leaf only if bushing eyelets are broken or worn OR if leaf is broken- bushing not included

					Year	New	Used
39-210M-F	front	1/2 ton only	each	47-55		\$139.95	
39-210M-R	rear	1/2 ton only	each	47-55		\$139.95	

Main Leaf Assist Spring

39-210A-F	2 nd leaf w/ curl at spring eye @ shackle			47-55		\$95.00	
-----------	--	--	--	-------	--	---------	--

Leaf Spring

39-210-F	set of good used 1/2 ton front-per side	47-55	Inquire	\$100.00
39-210-R	set of good used 1/2 ton rear-per side	47-55	Inquire	\$100.00

. For rear leaf spring setups, these items help correct your rear end to **driveshaft angle** and eliminate vibration during operation at all speeds. Misalignment is common on lowered and lifted vehicles Our axle shims are also an important item when you have added power steering to your vintage straight axle front end.

Original straight axle front ends came with minimal caster angle to make steering easier on the driver. When power steering is added, the **caster angle** must be increased or "road wander" becomes prevalent.

Pinon & Caster Angle Shim set

39-0004-FR	2 " wide 4 deg w/ bolt-ft caster or rear pinion angle	47-54 3/4 ton & 55-59 1/2-3/4 ton	47-59	\$52.95
39-2004	original castor shims 1 3/4 wide	pair	47-55	\$10.00

Leaf Spring Center Bolt w/nut ----- confirm size

39-0211-3/8	3/8 x 7 "	each	47-72	\$5.95
39-0211-5/16	5/16 x 5 "	each	47-72	\$5.95

Front I Beam

38-240	1/2 ton or 3/4 ton	47-55		\$250.00
--------	--------------------	-------	--	----------

Bill's Truck Shop

Phone (905) 725-3460 / (905) 725-2022 / Fax (905) 404-2302 email: bill@billstruckshop.com

Suspension

Due to the fluctuation of the Canadian and American dollars call for current prices

Group 39

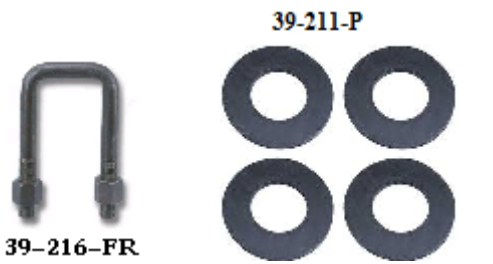

Rear Axle Spring Seat Side Pads

39-211-P set of 4 47-49 \$6.95

U-Bolts w / nuts ----- 5 " tall

39-216-FR for 1 3/4 " spring front or rear each 40-55 \$16.95

Shock Absorber –cylinder type gas shocks-can also be installed on 47-49 trucks w/ 50-55 w/ brackets Also lower bkts require replacing as they are not the correct angle for cylinder shocks -

39-213-F gas /front 1/2 -3/4 & 1ton each 10.250 short-16 3/4 extended 50-55 \$64.95

39-213-R gas/rear 1/2 & 3/4 ton each 12.50 short—21.250 extended 50-55 \$64.95

39-214 lever action type -inquire -front or rear 47-49 Inquire

Shock bushing kit- 2 bush , 2 washers , 1 nut

39-0134 1 end \$5.95

Shock Absorber Mount Brackets w/cylinder shocks-can also be used on 47-48 to upgrade shocks to cyl type Also lower bkts require replacing as they are not the correct angle for cylinder shocks

39-215 upper left or right/front or rear -each 47-55 \$49.95

Lower shock brackets are FLAT w/ lever action shock

39-215-47FLR lower front right w/ lever shock 47-49 \$15.00

39-215-47FLR lower front left w/ lever shock 47-49 \$15.00

39-215-FLR OE style front lower – right 49-55 \$28.95 \$15.00

39-215-FLL OE style front lower – left 49-55 \$28.95 \$15.00

39-215-RL rear lower - left or right w/ hdw 49-55 \$44.95 \$15.00

Want to lower your truck

-remove leafs- 7 on front (8) and 7 (9) on rear and used the(1") shorter ft shackles on rear - an inexpensive to lower the overall height of the truck by 2 " to 3 "

Lever Action Shocks

Inquire by year and position

Bill's Truck Shop

Phone (905) 725-3460 / (905) 725-2022 / Fax (905) 404-2302 email: bill@billstruckshop.com

Suspension

Due to the fluctuation of the Canadian and American dollars call for current prices

Group 39



		<u>Year</u>	<u>New</u>	<u>Used</u>
Shock Absorbers-SINGLE Action Lever Style- rebuilt and painted ready to operate like new				
39-214-C	core charge on front & rear shocks	47-49		\$25.00
39-214-RF	1/2 & 3/4 ton right front	47-49	\$145.00	
39-214-LF	1/2 & 3/4 ton left front	47-49	\$145.00	
39-214-RR	1/2 right rear	47-49	\$145.00	
39-214-LR	1/2 left rear	47-49	\$145.00	
Shock Absorber Link w/ single action shocks- includes bushings ,pins and sleeves-hole to hole 8 1/2 long				
39-214-1	front	each	47-49	\$28.95
39-214-1	rear	each	37-49	\$28.95
Shock Absorber Link w/ double action shocks				
39-215-1	vertical rod at rear		37-49	\$29.95
Shock Link Bushing Kit				
39-214-B	2x bushing w/sleeves, pins w/ single action shock		30-49	\$23.95
39-215-B	single rubber bushing-each		37-49	\$14.00
39-0215-BK	pair lower bushing & washers w/ 7/16 pin style link 1 kit per shock		37-49	\$8.95
Axle Bumper				
39-218F	front 1/2 ton	each	40-55	\$13.95
39-0218	47-55 rear & 55-59 ft & rear	each	47-59	\$10.95
15-0560-BP	universal application axle/frame /control arm bumpers polyurethane 2" tall pr			\$36.95
Axle Bumper Support & spring u-bolt seat				
39-218-S	cast housing for bumper at front spring	each	47-55	\$ 10.00
Steering Drag Link-pitman arm to steering knuckle--- 12" stud to stud				
39-223-47	1/2 - 3/4 -1 & 1 1/2 ton		47-52	\$159.95 \$50.00
39-223-53	1/2 - 3/4 -1 & 1/ 1/2 ton		53-55	\$199.95 \$75.00
Tie Rod Repair kit and 41-52 drag link				
39-0220-RK	1/2 - 3/4 & 1 ton for both sides		29-59	\$42.95
Ball Stud-threaded installation type				
39-225-P	(3/4 shoulder) on pitman arm		34-52	\$32.95
39-225-S	(5/8shoulder) on end of steering arm		47-52	\$44.95
39-0225-2	(1/2shoulder) at tie rod end 1/2 ton -each		34-59	\$49.95
39-0225-3	1/2 tapered shaft at tie rod end 3/4 ton - each		46-59	\$39.95

Bill's Truck Shop

Phone (905) 725-3460 / (905) 725-2022 / Fax (905) 404-2302 email: bill@billstruckshop.com

Steering

Due to the fluctuation of the Canadian and American dollars call for current prices

Group 39

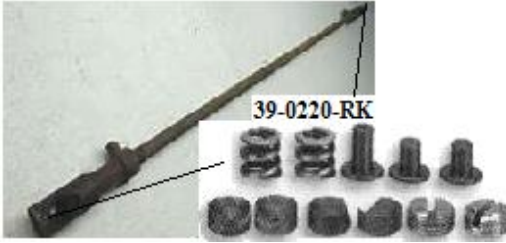
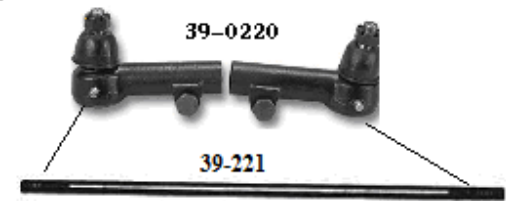

Tie Rod Ends-----NEW style w/ solid male bar
 39-0220 replacement type- pr 1/2 and 3/4 ton-
 requires solid treaded bar between wheels see # 39-221

Tie Rod Link-solid bar with male treaded ends
 Some tie rod links came w/ hollow tube -need to replace to solid
 bar type when upgrading to new style tie rod ends -threads on
 bar-**wire wheel sealer of threads before installing ends**

39-221 between wheels 1/2 ton 47-55 \$79.95

Tie Rod Repair kit and 41-52 drag link

39-0220-RK 1/2 - 3/4 & 1 ton for both sides 29-59 \$33.95

Tie Rod Ends ---- NEW style w/ hollow style w/ female
 bar 1/2 & 3/4--tapered shaft

39-0222-L left tie rod end 34-59 \$69.95

39-0222-R right tie rod end 34-59 \$69.95

39-0222-B center hollow bar 47-55 \$40.00

39-0035 1 & 1 1/2 ton left 34-59 \$84.95

39-0036 1 & 1 1/2 ton right 34-59 \$84.95

3.38 in Length; with .812 in x 18 Threads

39-0035/6 center bar-need measurement 34-59 \$100.00

Tie Rod Cup Boot

39-0176 w/ 9/16 shaft diameter each \$5.95

39-0177 w/ 5/8 shaft diameter each \$5.95

Grease Fittings

39-0225 large 1/8 pipe thread -straight pair \$2.95

39-0227 large 1/8 pipe thread - 45 deg pair \$7.95

Year New Used

Bill's Truck Shop

Phone (905) 725-3460 / (905) 725-2022 / Fax (905) 404-2302 email: bill@billstruckshop.com

Steering

Due to the fluctuation of the Canadian and American dollars call for current prices

Group 39



Pitman Arm

40-2055 47-52 w/ ball stud and 52-54 w/o stud

Pitman-Sector Shaft Seal

40-0055 47-72 w/ manual steering

Pitman-Sector Bushing kit

40-0056 2 brass bushing w/ seal

Pitman Shaft Nut w/ lock washer

40-0055-N w/ manual steering box

Steering Box –used sold as “AS IS “

Rebuilt columns do not include new upper bearing- #18-0311-confirm if required—includes 5-0230-N Grease packed during assembly-no lube required-tube length- top of box casting to top of tube-rebuilt require exchange core

40-208-47-3 3-speed-column shift

40-208-47-4 4-speed-floor shift

40-208-54-3 3-speed-column shift

40-208-54-4 4-speed-floor shift

Steering Box Thrust Bearing 9only) upper or lower

40-0790

Steering worm gear w/ shaft

40-208-S

Steering box- lower bearing w/ threaded adjuster

40-0149

Steering Box -bearing w/ race -lower worm gear

40-0141

Upper Column Bearing -

18-0311 with horn wire

Steering Wheel Retaining Nut w/ washer

5-0230-N

Steering Box Rebuild Kit Includes bearings w/race, bushings, gaskets , seal ,bearings and instructions

40-201-1 does not include ball bearing set

Steering Box Bearing set

40-0001 60 pcs 9/32 steel ball bearings

Steering Box Gasket set

40-0808 end cap & cover 41-46 &55-59

40-2808 end cap & cover 47-55

Year New Used

\$50.00

\$18.95

\$42.95

\$4.00

\$395.00 \$150.00

\$395.00 \$150.00

\$395.00 \$150.00

\$395.00 \$150.00

\$44.95

\$249.95

\$109.95

\$69.95

\$84.95

\$1.95

\$140.95

\$34.95

\$9.95

\$7.95

Bill's Truck Shop

Phone (905) 725-3460 / (905) 725-2022 / Fax (905) 404-2302 email: bill@billstruckshop.com

Steering

Due to the fluctuation of the Canadian and American dollars call for current prices

Group 39



40-209-6

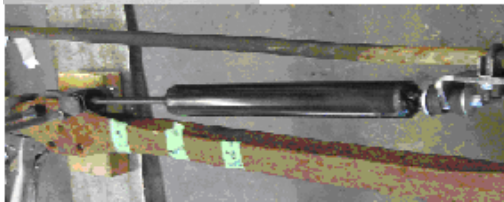
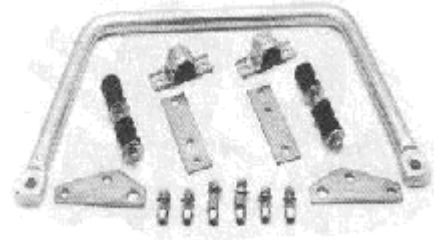

Sway Bar Kit -front Includes mounting hardware and instructions. Reduces body roll & wandering w/stock I beam suspension

45-208-K	1 1/8 bar	47-55	\$329.95
----------	-----------	-------	----------

Sway Bar Bushing Kit for original sway bar

40-209-6	6 pc set-1/2 ton panel-suburb	47- 51	\$89.95
----------	-------------------------------	--------	---------

40-209-8	8 pc set-1/2 ton panel-suburb	51-55	\$89495
----------	-------------------------------	-------	---------

Steering Stabilizer Kit-improves steering --NEW design-anchors at **REAR** u-bolt of leaf spring & drag link--improve steering ability, Kit includes stabilizer unit and mounting hdw-may require replacing 1 u-bolt (39-216-FR) if it cannot be removed

40-0207		47-59	\$159.95
---------	--	-------	----------

FRAMES

NEW FRAMES ----contact

Hitman Hotrods-----519-620-0800

Web site-----www.hitmanhotrods.com

e-mail -----info@hitmanhotrods.com

Bill's Truck Shop

Phone (905) 725-3460 / (905) 725-2022 / Fax (905) 404-2302 email: bill@billstruckshop.com



Mounts-Engine-Trans-Body

Group 40

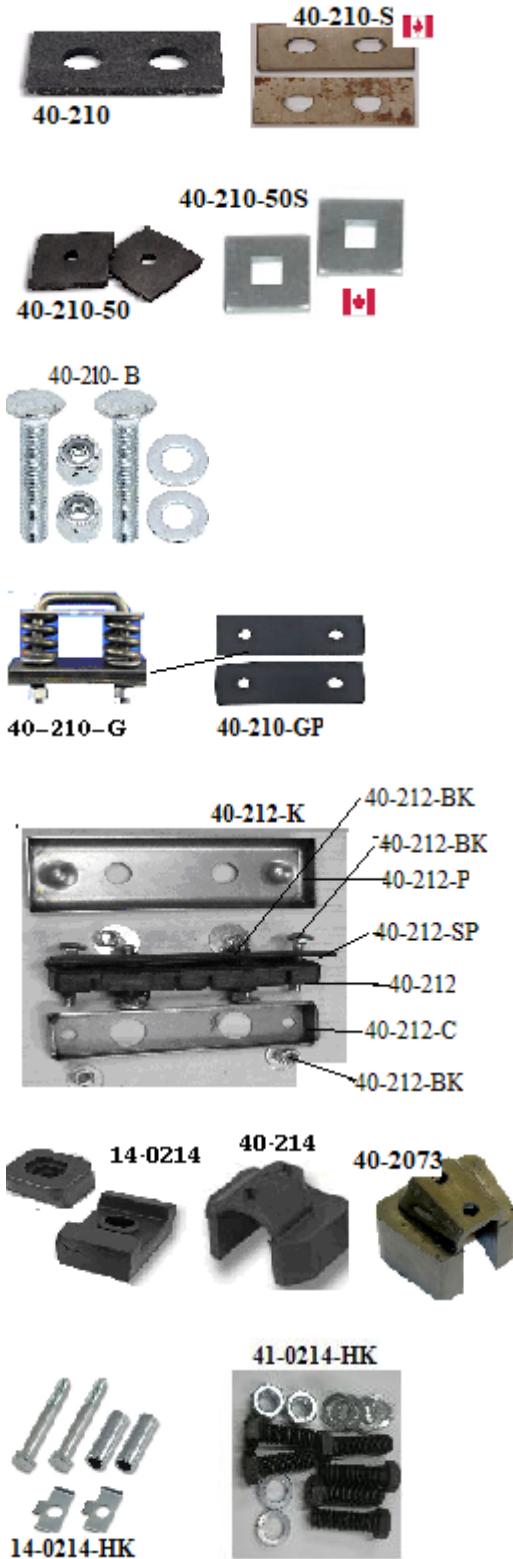

		<u>Year</u>	<u>New</u>	<u>Used</u>
Radiator Support Mounting Pads				
40-210	1 pad w/ 2 holes---center mount	47-49		\$2.50
40-210-50	2 pads----- side / side mount pair	50-55		\$3.95
Radiator Support Shim-helps correct fit sheet metal alignment				
40-210-S	1/8 thick pair	47-49		\$5.95
40-210-50S	1/8 thick pair	50-55		\$5.95
Radiator Support Bolt Kit				
40-210- B	pair	47-55		\$2.50
Radiator Support Mount Assembly-GMC				
40-210-G	w/ u- bolt, springs, plates, pads	47-55		\$69.95
Radiator Support Pads-GMC				
40-210-GP	pair	47-53		\$4.00
Front Motor Mounts Pad				
40-212		32-55		\$19.95
Front Motor Mount Pad Cup				
40-212-C		32-55		\$15.00
Front Motor Mount Pad Shield				
40-212-P		32-55		\$14.95
Ft Engine Mount Bolts—4 bolts w/hdw				
40-212-BK	2 x 3/8 @ cushion to frame (2 bolts washer& lock nut) and 2 x 7/16 at engine to cushion plate	32-55		\$5.95
Ft Engine Pad Support Plate				
40-212-SP		32-55		\$15.00
Ft kit-Chev				
40-212-K		32-55		\$99.95 \$40.00
Rear Motor Mounts				
40-214	each	37-53		\$24.95
14-0214	1 upper & 1 lower- also 54-59 w/auto trans	54-72		\$32.95
40-2073	1937-1947 Chevrolet).(1939-1959 GMC) (1947-1953, 3/4, 1, 1 1/2, 2 ton Chevrolet and GMC)..(1952 -1953 GMC with Hydromantic Trans (wedge shape-3 " wide) each	37-59		\$29.95
Rear Motor Mount Install hdw kit				
41-0214 HK	for both sides	37-53		\$9.95
14-0214-HK	sleeves/bolts & locks 6 pcs 2 sides	54-95		\$26.95

Bill's Truck Shop

Phone (905) 725-3460 / (905) 725-2022 / Fax (905) 404-2302 email: bill@billstruckshop.com

Mounts-Engine-Trans-Body

Group 40



40-227-47



40-227-49S



40-227-P

Rear Transmission Mount 3 speed trans only

40-215 complete steel /rubber bracket assembly 48-55 \$137.95 \$75.00

40-216-K includes 40-216 w/ up support & lower bolt retainer -fits 3 speed trans 47-55 Inquire

40-216-K4 includes 40-216 w/up support & lower bolt retainer w/ 4 speed trans 47-55 Inquire

40-216-B upper brace w/ lower plate 47.55 \$49.95

Rear Transmission Mount Repair Pads w/Bolts

40-216 2 pads/2 bolts 47-55 \$10.95

Cab Mount Kit With hardware

40-227-47 w/ center mount hdw & side bumpers 47-48 \$139.95

40-227-47S original centre support assembly 47-48 \$100.00

40-227-49 w/ side shackle mounts 49-55 \$39.95

40-227-49S cab to frame shackle set
NOTE- the frame bracket mount holes could be vertical or on an angle—may require frame drilling 49-55 \$239.95 \$150.00

40-227-P panel, suburban, canopy express 47-55 \$72.95

Shims

40-227-49S 49-55

Plate Nut---inside cab

40-227-49N pair 49.55

Bill's Truck Shop

Phone (905) 725-3460 / (905) 725-2022 / Fax (905) 404-2302 email: bill@billstruckshop.com

Group 40

Year New Used

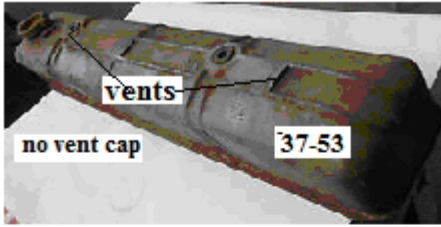

VALVE COVERS

w/ breather vents

Inquire



No vents w/ vented oil cap-CHEVROLET embossed

Inquire



w/ side breather vents w/o vented oil cap

Inquire

Bill's Truck Shop

Phone (905) 725-3460 / (905) 725-2022 / Fax (905) 404-2302 email: bill@billstruckshop.com

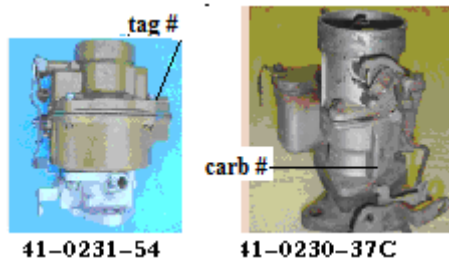

INFO-before ordering-confirm carb w/ tag# / carb # and or visual ID carb kits are NOT RETURNABLE also carb mount stud spacing --- - kits do not include float

Carburetor Rebuild kit

		<u>Year</u>	<u>New</u>	<u>Used</u>
41-0111	Carter YF---	32-62		
/54-55AMC 50-53IHC /50-67Jeep /51-54 Kaiser-Nash				
41-0063	Carter W-1 ---	32-48		\$63.50
47 Kaiser				
41-0065	Carter W 1---	49-49		\$169.65
41-0064 Carter W-1---				
41-0158 Rochester 6 cyl				
		41-52		\$102.95
		50-62		\$127.65
				\$47.95

Carb Float

41-0093	Carter YF---	37-67		
Chev & GMC truck / AMC 54-76 Checker Motors / 64-65 Chev car / 37-67 Ford & Mercury / 67-74 Ford truck / 68-82 International / 50-53 Jeep / 50-76 Kaiser & Frazer 51-54 Nash / 55 Olds / 66-67 Opel (Buick) / 68 72 Pontiac / 64-67 Studebaker				
41-0095	Rochester w/	6 cyl	41-62	\$34.95

Carburetor \$50.00 core charge if no correct core

Carter carbs were used as a replacement

41-0230-37C	YF	Carter 216	37-53	Inquire
41-0230-54C		Carter 235	54-62	Inquire
41-231-47	Rochester	2 3/4 stud spacing	47-53	Inquire
41-0231-54	Rochester	2 15/16 stud spacing	54-59	Inquire

Carburetor Insulation Plate

41-0231-0	216/235 w/	-2 3/4 stud spacing	37-53	\$11.95
41-0231-1	235 w/	2 15/16 stud spacing	54-62	\$11.95

Carburetor Base Gasket

41-0231-0G	216/235 w/	2-3/4 stud spacing	37-53	\$6.95
41-0231-G	235 gasket -	2 15/16 stud spacing	54-62	\$3.95

Bill's Truck Shop

Phone (905) 725-3460 / (905) 725-2022 / Fax (905) 404-2302 email: bill@billstruckshop.com

Engine Parts

Group 41

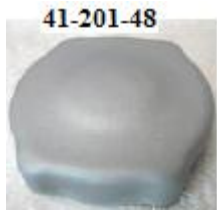

41-0201-54



41-0201-49



41-203

41-203-N

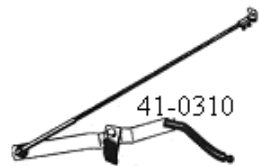

41-0310

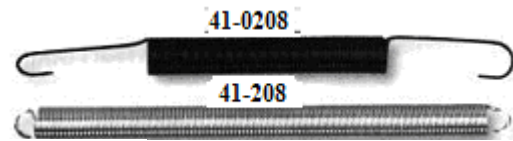

41-0208

41-208



41-208-B



41-0211-S



41-0211-R

41-0211-K

41-0211

41-0211-L

Oil Filler Cap----see previous page for info

	<u>Year</u>	<u>New</u>	<u>Used</u>
--	-------------	------------	-------------

41-201-48	fits on breather pipe-	37-48	\$12.95
-----------	------------------------	-------	---------

41-0201-49	on valve cover -twist on / not vented w/ vented valve cover	49-78	\$7.50
------------	---	-------	--------

41-0201-54	on valve cover/vented 6 cyl w/ non vented valve cover	54-67	\$10.95
------------	---	-------	---------

Valve Cover Grommets

41-203-G	w/ 2 center bolts	pair	47-53	\$4.00
----------	-------------------	------	-------	--------

Valve Cover Nuts- Acorn style-stainless steel

41-203-N	34-53 Chev & 39-59 GMC	pair	34-59	\$6.95
----------	------------------------	------	-------	--------

41-203-NS	34-53 Chev & 39-59 GMC	stain-steel/pair	34-59	\$9.95
-----------	------------------------	------------------	-------	--------

Accelerator Return Spring

41-208	6 cyl	47-49	\$14.95
--------	-------	-------	---------

41-0208	6 cyl	50-59	\$8.95
---------	-------	-------	--------

Accelerator Spring Mount Bracket

41-208-B	secures to oil pan for spring	41-53	\$5.75
----------	-------------------------------	-------	--------

V8 Throttle Linkage-for converting to V-8

41-0310	47-52 require 53-57 gas pedal	47-59	\$89.95
---------	-------------------------------	-------	---------

Spring-Starters pedal return

41-0211	47-59	\$5.50
---------	-------	--------

Link-Starters pedal return

41-0211-L	47-59
-----------	-------

Rod-Starters pedal @ starter

41-0211-R	47-59
-----------	-------

Tension spring kit-@ starter pedal rod

41-0211-K	47-59	\$2.95
-----------	-------	--------

Spring-starters pedal shaft anti rattle spring

41-0211-S	47-59	\$4.95
-----------	-------	--------

Accelerator Swing Bolt on engine block

41-0209-S	37-49	\$24.95
-----------	-------	---------

41-209-S	50-55	\$25.00
----------	-------	---------

Bill's Truck Shop

Phone (905) 725-3460 / (905) 725-2022 / Fax (905) 404-2302 email: bill@billstruckshop.com

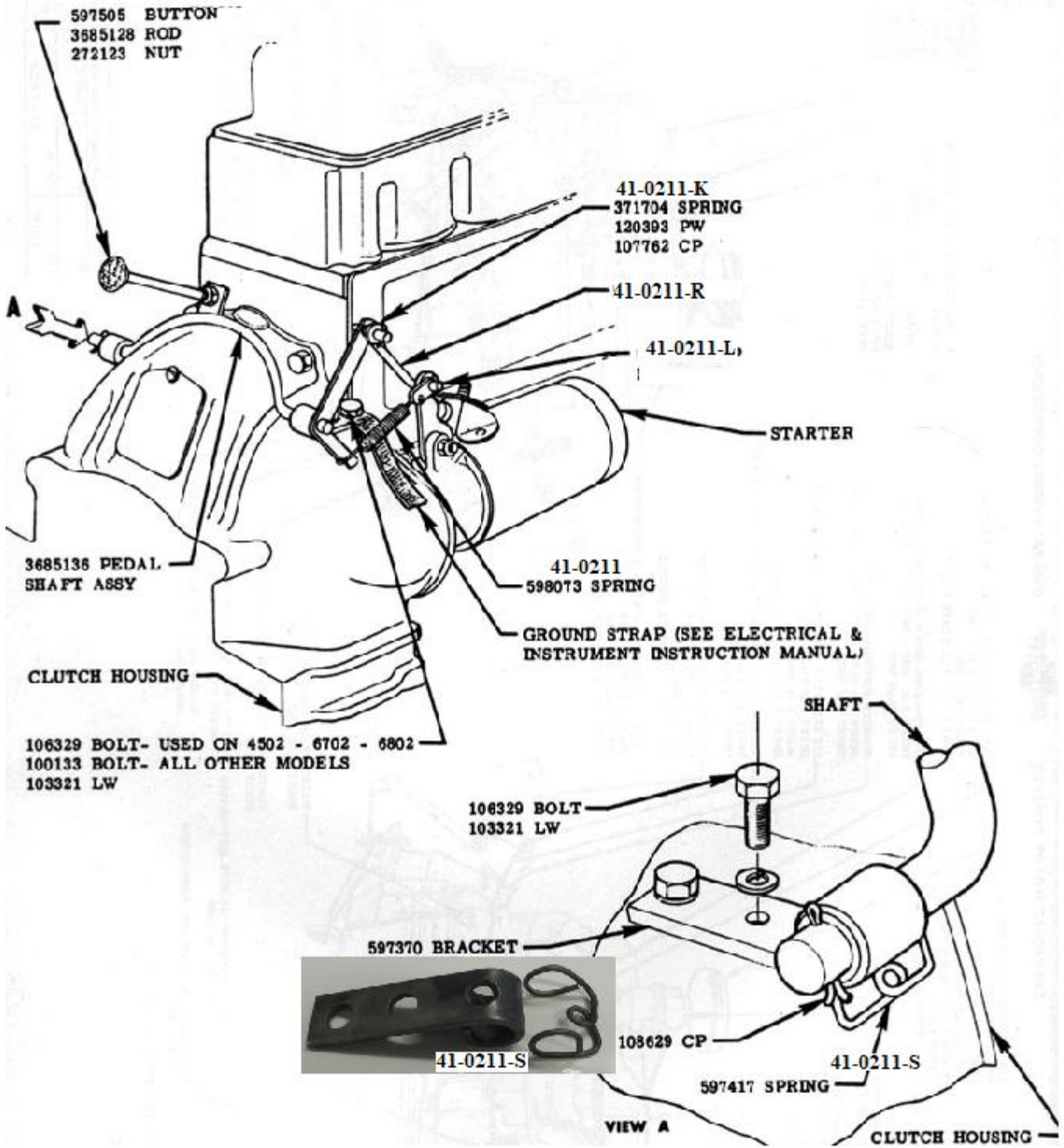

Engine Transmission

Group 41



Clutch Fork Ball Stud

41-0216-S w/ 7 1/6 shaft—6 cyl only

38-59

\$17.95

\$5.00

41-0216-S1 with 3/4 shaft—V 8 only

55-72

\$22.85

\$5.00

Clutch Fork /Ball Stud Spring clip

41-0217

38-72

\$14.95

Clutch Fork

41-0218-F

47-59

\$25.00

Clutch Fork Boot

41-0213 OE style w/ spring

47-59

Inquire

Bill's Truck Shop

Phone (905) 725-3460 / (905) 725-2022 / Fax (905) 404-2302 email: bill@billstruckshop.com

CLUTCH

Group 41



Pilot Bushing

41-0440 fits 6 & 8 cyl 47-87 \$19.95

Clutch Release Bearing

41-0086 6 cyl & most V8 1 7/8 long 38-75 \$79.95

41-0087 1 1/4 long 47-84 \$64.95

Clutch Disc

41-0230-D 9 1/8 w/ 3 speed trans 38-53 NLA

Clutch kit

41-0230 NEW 9 1/8" clutch w/ pressure plate Release bearing, pilot bushing & align tool all w/ 3 speed transmission w/6 bolt pressure plate 38-53 \$395.95

41-0230-R REBUILT 9 1/8" clutch w/ pressure plate all w/ 3 speed trans core exchange required 38-53 Inquire

41-0234-R REBUILT pressure plate only w/ 6 bolts to secure to flywheel 38-53 Inquire

41-0236-R REBUILT pressure plate only w/ 9 bolts to secure to flywheel 10 3/4 face-- 1/2 - 3/4- 1-1/12 & 2 ton 38-53 Inquire

41-0231 NEW 10 1/2" clutch w/ pressure plate release bearing, pilot bushing all w/ 3 speed transmission secures w/ 6 bolts w/ 11.5 spacing 54-62 \$325.95

41-0049 NEW 11 clutch kit w/ 4 speed trans 51-62 \$249.95

TRANSMISSION

-speedo gear w/ housing---3 or 4 speed \$75.00

Flywheel

5 bolts w/ 3 dowel holes for clutch # 41-0230 GM casting # 839754-777 139 teeth

Bill's Truck Shop

Phone (905) 725-3460 / (905) 725-2022 / Fax (905) 404-2302 email: bill@billstruckshop.com

Engine Transmission Parts

Group 41

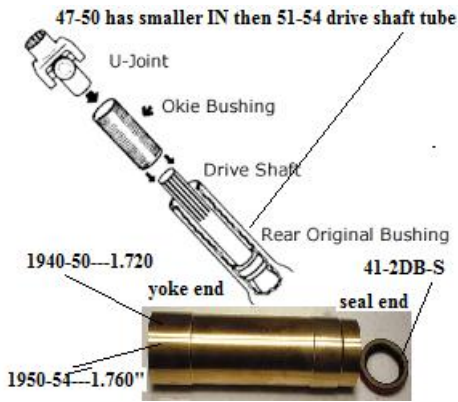

41-0UJK



41-UJG

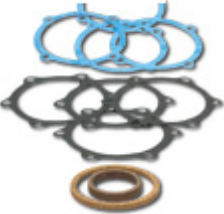

41-0UJR



41-2DSC



41-2201

Transmission Gasket Set

Part	Year	New	Used
41-2TG-3 3-speed	37-55	\$42.95	
41-02TG-4 39-72 SM420 & 48-65 Muncie 4-speed	37-72	\$19.95	

Drive Shaft Bushing- help to prevent u-joint damage and oil leaks.

41-2DB 40-50 cars - 1/2 chev & 40-50 GMC 1/2 ton 1.720 OD of bushing	40-50	Inquire	
--	-------	---------	--

41-2DB-1 1/2 ton Chev & GMC 1.760 OD of bushing	51-55	Inquire	
---	-------	---------	--

Drive Shaft Bushing Seal

41-2DB-S 1/2 ton	40-50	\$21.95	
41-2DB-1S	51-55	\$12.95	

U-Joint Repair Kit

41-0UJK 1/2 ton 3 and 4 speed	40-55	\$109.95	\$30.00
-------------------------------	-------	----------	---------

U-Joint Ball Seals and Gasket set

41-UJG 1/2 & 3/4 tons	29-53	\$39.95	
-----------------------	-------	---------	--

U-Joint Retainer

41-0UJR cup retainer only	40-54	\$3.95	
---------------------------	-------	--------	--

Yoke Assembly

41-2Y4 4 speed 1/2 ton	48-55		\$75.00
41-2Y3 3 speed yoke	48-55		\$75.00

Cushion-driveshaft carrier

41-2DSC 3/4 & 1 ton	47-53	\$26.50	
---------------------	-------	---------	--

Pivot-driveshaft yoke cover w/ retainer

41-2201 3 speed trans	47-53		\$75.00
-----------------------	-------	--	---------

Tube-Driveshaft-outer

47-50 1.720 ID of tube at yoke end			\$100.00
51-55 1.760 ID of tube at yoke end			\$100.00

Transmission Yoke

41-2200-3 3 speed-slips in trans	47-55		\$175.00
41-2200-4 4 speed-bolts into trans			\$175.00

Bill's Truck Shop

Phone (905) 725-3460 / (905) 725-2022 / Fax (905) 404-2302 email: bill@billstruckshop.com

Transmission

Group 41

Year New Used



Gear select tension spring w/ retainer



2 different styles side covers w/ selectors

worn gear select guide-will cause transmission to drop out of gear

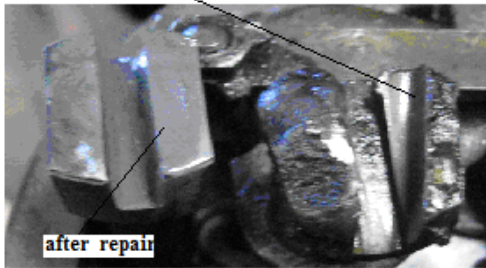

Gear selector in side cover-causes transmission to move into neutral

Selector fork exchange

\$150.00

41-0000



Transmission-gear speedometer

41-0000 inquire - 3 or 4 speed -require gear count

\$50.00

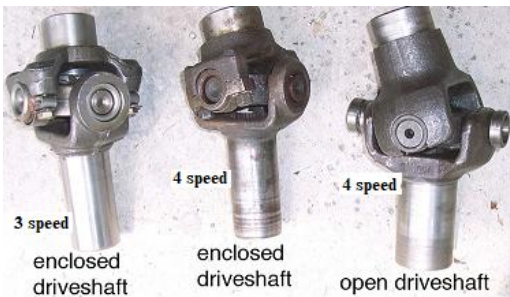





Muncie-1940-63 Cars, 1940-68 Light Duty Trucks: Cast iron case and extension housing with 4-bolt side cover. Has non-synchro 1st and a "barrel" type 2/3 assembly. Units from 1940-54 have enclosed driveline, otherwise known as a "torque tube". Those from 1955-68 may have electric overdrive. Some of 1964-65 units have larger gears with the same tooth count as the 1940-68 units.

Bill's Truck Shop

Phone (905) 725-3460 / (905) 725-2022 / Fax (905) 404-2302 email: bill@billstruckshop.com

Transmission

Group 41

			<u>Year</u>	<u>New</u>	<u>Used</u>
	41-233-L	Bell Housing			
	41-2800-47	47-49 has no shift lever pivot bolt on left side-used w / 3 speed floor shift trans	47-49	\$75.00	
	41-2800-50	w/ 3 speed column shift trans			
		Bell Housing Upper Inspection cover			
	41-0280-C	w/ hdw			
		Transmissions sold as is –visual internal inspection only			
	41-23TL	top loader 3 speed			Inquire
	41-23SS	side shift 3 speed	48-55		Inquire
	41-24TL	SM420 top loader 4 speed	47-68		Inquire
		Shifter Levers-			
	41-233-L	secures to trans selector shafts- both levers are the same			
		sold as each	51-55		\$20.00
		Transmission Shift Lever Tension Spring kit-3 speed column shift			
	41-223-SK	4 springs washers & cotter pins	49-55	\$14.95	
		Shift Repair bushing w/ spring			
	41-0136	corrects loose shift lever on 3 speed top loader	37-47	\$36.95	
	41-0136				
	41-0SM420-TS	SM420 4 speed trans			
		The SM-420 4-speed transmission was produced by General Motors between the years of 1947 & 1967. Starting in 1966 General Motors offered the NP-435GA for its light truck applications as an option. The NP-435-GA became the standard 4-speed sometime in the late 1960s. The cast iron case with large bulge on the passenger side makes the SM-420 easy to identify. Ribbing was added to the bulge on later cases, The ribbed SM-420 case should not be confused with the later SM-465 transmission. How can you tell which 4-speed your 1966 has, if reverse is to the driver & down, it's the SM-420, if to the passenger & down			
		SM420 4 speed transmission parts			
		Tailstock/rear yoke seal			
	41-0SM420-TS		47-67	\$38.95	
		Bearings-transmission			
	41-03305	main shaft rear ---3 speed	37-54	\$69.95	
	41-03305				
	41-03207	ft input bearing---3 speed	38-67	\$62.95	

Bill's Truck Shop

Phone (905) 725-3460 / (905) 725-2022 / Fax (905) 404-2302 email: bill@billstruckshop.com

Parts – Transmission Rear axle

Group 41



41-0225



41-0225-G



41-0970



41-0695



41-0305



41-0304



41-0011-S



41-0502-EL



41-0011-F



41-0011-R



41-0011-SK



41-0088



41-0TOOL

	Year	New	Used
Rear Ends---- USA or Canadian built			
41-260-47	w/ early style brakes-	47-49	\$250.00
41-260-51	shaft tube length 60 1/8	49-54	\$250.00
Rear Axles 1/2 ton			
41-260-A	17 splines left longer than right--each	47-55	\$150.00
Axle Seals-rear			
41-0695	1/2 ton each	38-63	\$25.95
41-081B	3/4 ton w/ out Dana rear axle-dana rear axle cover has straight sides-other axle has round cover	47-72	\$25.80
41-0870			
Rear Axle Plug w/ gasket			
41-0225		47-62	\$19.95
41-0225-G	plug gasket (leather)	47-62	\$4.50
Rear Axle Cover Gasket			
41-0304	1/2 - 3/4 10 bolt rear end 37-63 Chev 39-66 GMC 1/2 ton 1/16 (.063) thick	37-66	\$7.95
41-0088	3/4 - 1 - 1 1/2 H072-52 Eaton w/ 10 bolt cover	37-72	\$22.95
Rear Differential Carrier Gasket			
41-0305	1/2 - 10 bolt rear end 37-63 & 37-45 3/4 ton 39-70 1/2 GMC 1/32 (.031) thick	37-63	\$7.95
Pinion Seal			
41-0970	3/4 - 1/ ton- 1 1/2 ton- w/ open drive shaft	46-65	\$40.95
Bearings			
Outer Axle Bearing			
41-0502-EL	1/2 ton outer each	38-62	\$92.95
Inner Axle Carrier Bearing			
41-0011-S	inner side bearings w/ race each	40-55	\$74.95
Pinion Bearing			
41-0011-R	rear pinion bearing-rear	36-54	\$139.95
41-0011-F	front pinion bearing-front	40-54	\$139.95
Pinion Shim kit w/ driveshaft pin			
41-0011-SK		40-54	NLA
TOOL			
41-0TOOL	pair of carrier adjust wrenches-available to borrow w/ return		Inquire

Bill's Truck Shop

Phone (905) 725-3460 / (905) 725-2022 / Fax (905) 404-2302 email: bill@billstruckshop.com

REAR END

Group 41

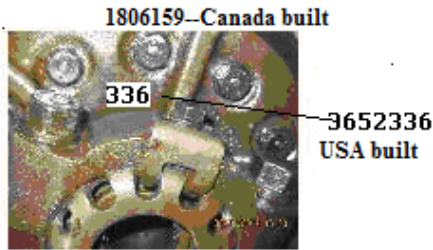

41-0260-CP

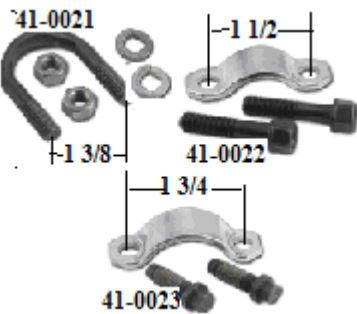

Rear Ends -Canadian & American built rear ends have different carrier size-US # 3652336/Ca # 1806159/ # is on rear facing of crown between cast webs eg 37-9= 4:11 ratio
When upgrading to the 3:55 rear gears the US carrier is required -cannot use the Canadian carrier

Ring/Pinion set 3: 55 – 1 includes complete instruction

	Year	New	Used
41-0260-CP	40-53	\$700.00	
41-0160-IK install kit seals-gaskets- bearings-torque bushing-shims-u locks	40-53	Inquire	
41-04:11 4:11 crown & pinion w/ bearings--USED	47-55		\$200.00

Tube-Driveshaft-outer

47-50	1.720 ID of tube at yoke end		\$100.00
51-55	1.760 ID of tube at yoke end		\$100.00

Rear Axle Vent @ some trans

16-0270	plastic w/ cover	64-72	\$4.95
16-0271	metal screw in	47-63	\$24.95
16-0270-K	rear axle vent w/ hose	60-87	\$11.95

U-joint Retainer

41-0021	1 3/8 center to center each		\$10.95
41-0022	1 1/2 center to center each		\$10.95
41-0023	1 3/4 center to center-metric each		\$11.95

Driveshaft Hanger Bearing Assembly

14-030-S	1.3780" ID	54-94	\$69.95
54-94 Support Driveshaft hanger bearing w/ side to side mount some early 3/4 and 1 ton			

Bill's Truck Shop

Phone (905) 725-3460 / (905) 725-2022 / Fax (905) 404-2302 email: bill@billstruckshop.com

FUEL PUMP

Group 41



Fuel Pump-requires using your OE fittings in pump- includes gasket---may require fuel line adjustment

41-0149 w/ glass bowl filter 37-62 Chev/39-59 GMC
 41-0429 w/o glass bowl 37-57 Chev/ when using this pump there should be a filter assembly @ carb #41-0668- pipe in and outlet hole in line OE style

41-0912 vac/fuel pump combination 39-59 GMC & 37-62 Chev
 41-2241 GMC 6 cyl

Fuel Pump Bowl-glass

41-0150-B

Fuel Pump Bowl-screen

41-0150-S brass inlet filter in bowl

Fuel Pump Fitting-in and out let pipe

41-0148---fitting 1/8 NPT male x 5/16 tube OD

Fuel Pump Rebuild kit

41-0149-RK glass bowl AC fuel pump

Fuel Hose

41-0516 5/16 neoprene hose ----per foot
 41-038 3/8 neoprene hose ----per foot

Gas Filter Assembly-OE GM option

41-0668 glass bowl w/ filter -mount at carb

Gas Filter Fitting hdw kit- installing at carb

41-0668-H 1 x 1/1/2 pipe—1 x straight -- 1x 90 deg line adaptor for straight or side pipe entry

Gas Filter

41-0668-F filter for glass assembly w/ gsk

Year New Used

37-62 \$179.95

37-57 \$119.95

37-62 \$159.95

47-53 \$55.00

41-62 \$10.00

41-62 \$10.00

\$3.95

37-62 \$139.95

\$3.49

\$3.49

40-62 \$37.95 \$15.00

40-62 \$18.95

40-62 \$8.95

Bill's Truck Shop

Phone (905) 725-3460 / (905) 725-2022 / Fax (905) 404-2302 email: bill@billstruckshop.com



41-0032
In-line fuel filter-steel-steel
41-0032 w/ hose & clamp

\$5.95



Oil Filter Assembly

41-0201-A original used assembly

Year

New

Used

37-62

\$75.00

Cartridge Oil Filter The Fram cannisters use a 7/8" wrench on the top bolt and have a crimped bottom w/ black top & orange canister-fram # C4 or C4P2 The A/C cannister uses a 5/8" wrench on the top bolt and has a smooth bottom.

Part Number	Dimensions	Type	Year	New Price	Used Price
41-0201-1	4 1/8 W x 5 9/16 H	FRAM	37-62	\$29.95	
41-0201-2	4 1/2 W x 5 H	AC	37-62	\$29.65	
41-0201-GMC	3 1/2 x 5 9/16 H	GMC ONLY located on right ft of 6 cyl engine	39-62	\$22.95	
41-0201-GMC-HD	4 W x 8 H	HD commercial	39-62	\$29.95	

Inquire



Oil Line Block kit - 3 pc set

41-0249-A 2 outlet plug for oil gauge and filter line-screws in block

47-62

\$19.95

41-0249-1	1/8 pilot nut-line compression fitting	\$2.35
41-0249-2	1/8 tube OD x 1/8 male pipe adapter	\$4.70
41-0249-3	1/8 NPT "T" 3 outlet female	\$4.95
41-0249-4	1/8 x 1" connector tube	\$2.35



41-0201-A



Oil Filter Decals

41-020F-1	W/ Fram type -- 6 cyl engine	47-59	\$9.95
41-2AC	W/ AC type-- 6 cyl engine	45-55	\$9.95



Oil Filter Lines

41-0249L	216-235 6cyl w/ nec fittings pair	37-62	\$64.95
----------	-----------------------------------	-------	---------

Bill's Truck Shop

Phone (905) 725-3460 / (905) 725-2022 / Fax (905) 404-2302 email: bill@billstruckshop.com

Engine Parts

Group 41



41-OGT



Generator Radio Warning Tag

41-OGT 47-62 \$4.95

Generator & Starter Tag----not numbered

41-000T w 12 volt gen or starter w/ rivets 55-62 \$8.95

41-000T-R pr of install rivets pair \$3.50

Air Breather

41-2OBB oil bath type 4 1/4 tall/8 1/2 wide 47-55 \$75.00

41-20WB oil wetted type 6 1/4 tall/10 wide 47-55 \$75.00

Air Breather Wing Nut-----check stud size

41-0741 1/4 x 20 40-66 \$0.75

41-0741-10 10 x 32 40-66 \$1.95

Air Cleaner Element

41-0238 6" oil wetted copper mesh filter 41-55 \$69.95

Engine Flywheel

41-2F 47-55 \$50.00

Inquire about good used 216 and 235 engines

41-216/235 47-55 Inquire

Harmonic Balancer

Early style w/ crank handle ears & 5/8 pulley
And later w / 3/8 pulley \$75.00

Dip Stick w/ tube

41-0299 v8 small block OE design 58-74 \$27.50

Bill's Truck Shop

Phone (905) 725-3460 / (905) 725-2022 / Fax (905) 404-2302 email: bill@billstruckshop.com

DECALS

Group 41



41-2VCD-47



41-2VCD-54



41-020C



41-020A



41-020B

Engine Valve Cover Decals

		<u>Year</u>	<u>New</u>	<u>Used</u>
41-2VCD-47	THRIFTMASTER	47-53	\$6.00	
41-2VCD-54	THRIFTMASTER 235	54-55	\$5.00	
41-2VCD-54J	JOBMASTER 261	54-55	\$5.95	

Air Cleaner Decals

		<u>Year</u>	<u>New</u>	<u>Used</u>
41-020A	oil bath type / angle style top –AC heavy duty	47-53 & 55-59	\$4.95	
41-020B	oil whetted element /flat style top –AC light duty	47-59 & 40-46 &	\$5.95	
41-020C	oil bath type-AC heavy duty	54-55	\$4.25	

Bill's Truck Shop

Phone (905) 725-3460 / (905) 725-2022 / Fax (905) 404-2302 email: bill@billstruckshop.com

Engine Parts-Radiator

Due to the fluctuation of the Canadian and American dollars call for current prices

Group 41



Rad Hoses (formed hose)

			Year	New	Used
41-2HU	1 3/16 "outlet	upper -6cyl	47-55	\$19.95	
41-02HU-B	1 1/2 " outlet	upper 60-62 235/261	47-62	\$30.95	
41-2HL	1 1/2 " outlet	lower-6cyl	47-55	\$42.95	
41-2HL-B	w/ later 235/261 engine---	w/ larger 1/3/4 outlet on pump-cut to fit 1 1/2 @ rad	47-55	\$39.95	

Thermostat Housing- when adding newer 235 engine reuse or purchase the earlier outlet for correct 1 1/2 house size—see page 154-155 for gaskets

18-0245	-outlet-thermostat	216- 235 6 cyl 1 1/4 outlet	40-54	\$69.95	\$20.00
18-0245-B	-housing-thermostat/base	216/235 6 cyl	40-62	\$69.95	\$30.00

Heater Hose Retainer w/ screw

22-0205	original used-	on pass inner fender	40-59	\$21.95	\$10.00
22-0205-1	heater or acc	AC line retainer	40-87	\$16.95	

Heater Hose —approx 3.5 to 4 ft required to secure on inner fender-MOST heater hoses are 5/8 -CONFIRM

18-0401	5/8 black-per foot			\$3.00	
18-0402	3/4 black-per foot			\$3.00	

Thermostat

18-0160	160 deg			\$14.95	
18-0180	180 deg			\$14.95	
18-0195	195 deg			\$14.95	

Radiator Hose Clamps OE style screw clamps

41-001-1/2	OE style upper	1 1/2	each	\$5.50	
41-001-3/4	OE style lower	1 3/4	each	\$6.95	
41-002-0	OE style lower	2"	each	\$7.95	
41-0220	1 1/2 - 2" screw type			\$1.65	
41-0228	1 3/4"-2" wrap- screw type		each	\$2.50	
41-004-3	2 1/16 – 2 1/4 OE style			\$7.95	
41-0044	2 1/16 – 2 1/4 wrap screw type				

Heater Hose Clamps

41-0220	up to 1" wrap- screw type		each	\$0.95	
41-0220-0	up to 1 " flat OE style		each	36-59	\$3.25

Radiator Cap

41-0RC	w/ non pressure system		37-52	\$11.50	
41-2RC-4	4 lb w/ pressure system-- Delco		47-55	NLA	
41-2RC-4A	4 lb w/ pressure system-replacement		47-55	\$14.95	
41-0RC-16	16 lb rad cap for non stock engine application		47-87	\$13.95	

Bill's Truck Shop

Phone (905) 725-3460 / (905) 725-2022 / Fax (905) 404-2302 email: bill@billstruckshop.com



41-0252

41-2RAD-GA-B



41-2RAD-CA-S



Radiator Dimensions:

Total: 22" tall x 22.13" wide w bkts
Core: 16.5" tall x 19.25" wide 2" thick
Inlet: 1.5" drivers side
Outlet: 1.5" passenger side
Tanks: 2.5" thick
Tubes: 0.63" thick

18-00HA-2



41-0254



GMC truck rad fill/cap are in front of the rad-(engine side) as the upper rad support/hood latch panel brace does not allow for top fill---Chev rad fill/cap are on top and the upper rad support/hood latch panel brace is on the front side of support---to fit OE style frames NOT S10

Radiators-brand new radiators in two different models-standard for 6&8 cyl (3 row tubes) or desert cooler for V-8 HD application (4 row tubes)- ½ " tubes @ 9/16 on center Chev only all have 1 ¼ inlet and 1/1/2 outlet pipe **copper / brass construction -Chev rad are top fill & GMC front**-when installing a SB Chev you can use 55-59 cyl rad hoses-call for more info 41-3U8 & 41-3L8 cut to fit

41-2070	20 ¾ x 19 ¾ x2 w/ 3 row- hose connection for 6 cyl application w/ trans cooler- requires fitting # 41-0252 when installing auto transmission	47-55	\$599.95
41-2070-4R	20 ¾ x 19 ¾ x2 w/ 4 row- V8 application w/ trans cooler	47-55	\$599.95

NEW ALUMIMUM - on OE 6 cyl confirm thermostat housing inlet side 1 ½ or 1 1/4

Core size is 19 1/4" x 22 3/4". Top Inlet is 1 1/4". Lower Outlet is 1 ½ for 6 cyl & 1 ¾ for 8 cyl application. These are welded construction there is no epoxy used in these radiators.-----trans fittings have flared seats for lines

41-2RAD-CA-BLS	w/ LS engine upgrade 3 row w/ up (1.1/4) & lower(1 ½) rad hose outlets on R side- includes steam port and auto cooler	47-55	\$449.95
41-2RAD-CA-B	3/row w/ auto cooler,14 lb rad cap Chev only w/V8 1 ¾ lower pass outlet OD & 1.5 up center inlet	47-55	\$424.95
41-2RAD-CA-BS	47-54 Rad/Chev 2/ row aluminum w/cooler V8	47-55	\$395.00
41-2RAD-CA-6	2/ row w/ auto cooler,14 lb rad cap Chev only w/ OE 6 cyl 1 ½ up--1 ½ lower outlet	47-55	\$325.00

GMC RAD

41-2RAD-GA-B	OE GMC has rad fill on side facing cab - 3/row w/ auto cooler,14 lb rad cap GMC only--	47-55	\$375.00
---------------------	---	-------	----------

41-2RAD-CA-S NEW ITEM

Replacement rad when installing a 1947-54 CHEV truck on an **S10 frame**-- 3- row aluminum rad w/ trans cooler--- may require minor modification FAN shroud# 41-2FS-1 will not fit this application

		47-55	\$419.95
--	--	-------	----------

41-2RAD-CA-SLS	same as above w/ LS engine	47-55	\$449.95
-----------------------	----------------------------	-------	----------

Radiator Petcock

41-0254	brass	40-87	\$8.95
---------	-------	-------	--------

Hose Adaptors

18-00HA-1	Hose adaptors -adjusts up from 1 ¾ to 2"	\$11.95
18-00HA-2	Hose adaptors -adjusts up from 1 1/2 to 1 ¾"	\$11.95

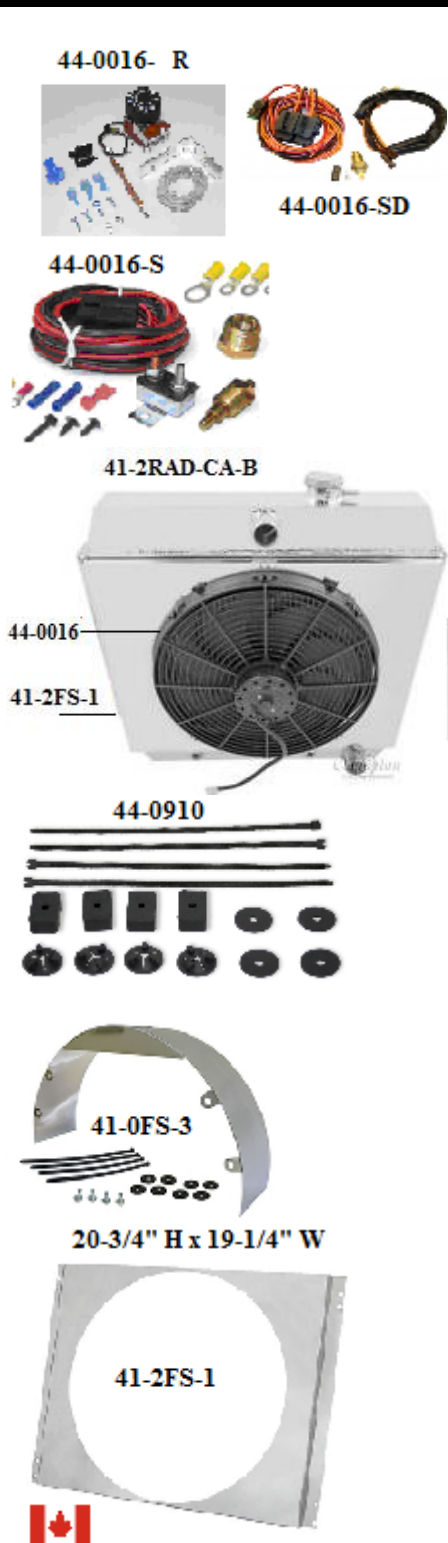

Relay-electric fan control

44-0016-R This adjustable electric fan switch with thermostat allows you to run your electric fan-installs temp probe in rad fins

Year	New
universal	\$42.95

44-0016-S

This Electric Fan Relay with Thermostat kit allows you to run your electric cooling fan in a much more efficient manner. It powers up your electric fan when your motor reaches -175-185 degrees F and powers down when your motor reaches 170 degrees F w/ temp sender 50-60 amp relay

universal	\$74.95
-----------	---------

44-0016-SD

Dual fan relay Kit, 80 Amps, 12V, temp sender, two 40 Amp relays, On at 195 degrees, Off 180 degrees, Harness, Kit

universal	\$114.95
-----------	----------

Electric Fan

44-0016 Produces a TRUE 2300 CFM Rating at 18.4 or 14 amp draw.

- This fan is 3 1/4" deep through the center of the motor; it gradually thins to 1 1/2" at the outer edge.
- Curved blades are quiet and push the same amount of air as a straight blade.
- Factory built as a puller, mounted inside and pulls the air through the radiator.
- 12V REVERSIBLE 'S' BLADE - Blades & polarity of the wiring can be reversed & it becomes a pusher

universal	\$99.95
-----------	---------

44-0014 13.82 " wide//2 58 " deep 1750 CFM 12 V 90 W reversible

universal	\$99.95
-----------	---------

44-0012 12 " wide 870 CFM 12 V reversible

universal	\$89.95
-----------	---------

Install Kit-electric fan

44-0910		\$18.95
---------	--	---------

Fan Shroud

41-2FS	plastic-cut for fan opening	47-55	\$69.95
--------	-----------------------------	-------	---------

Fan Shroud

41-2FS-1	aluminum shroud -accepts 1 single 16" electric fan 20 3/4" H x 19 1/4 W secures to rad	47-55	\$114.95
----------	--	-------	----------

Universal-----upper fan guard

41-0FS-3	polished stainless steel 3" deep x 20 dia	universal	\$42.00
41-0FS-5	polished stainless steel 5" deep x 20 dia	universal	\$42.00



Bill's Truck Shop

Phone (905) 725-3460 / (905) 725-2022 / Fax (905) 404-2302 email: bill@billstruckshop.com

Water Pump -ETC

Due to the fluctuation of the Canadian and American dollars call for current prices

Group 41

Water Pump Year New Used

5/8 pulley has 2 1/4 fan bolt spacing--
 41-2165 Chev- NEW 216-235 w/ 5/8 pulley
 on block and head 41-52 \$169.95

41-2166 Chev -NEW 216-235 w/ 3/8 pulley
 -on block only 53-55 \$219.95

41-0167 GMC-NEW w/ 5/8 groove pulley 6 cyl 39-59 Inquire

41-0167-R GMC-REBUILT w/ 5/8 groove pulley
 6 cyl Inquire

41-0168 GMC w/ 7/8 groove pulley 39-59 Inquire

GMC water pumps outlets are opposite of Chev
Water Pump-conversion-shortened 55-59 water pump
 w/ 3/8 belt pulley when installing 1955-62 235 CI engine
 in 1954 earlier truck-no need to move rad forward-see 2
 styles

41-235-K w/ 4 1/4 pulley for 3/8 belt -use early 216 fan \$319.95

41-235-K1 w /6" pulley ,spacer for 3/8 belt-use 1955
 up 235 fan \$319.95

41-2HL-B HOSE w/ later 235 w/ larger 1/3/4 outlet on
 pump 47-55 \$34.95

**Heater hose fitting @water pump & thermostat
 housing**

41-0881 5/8 hose fitting 41-54 \$17.95

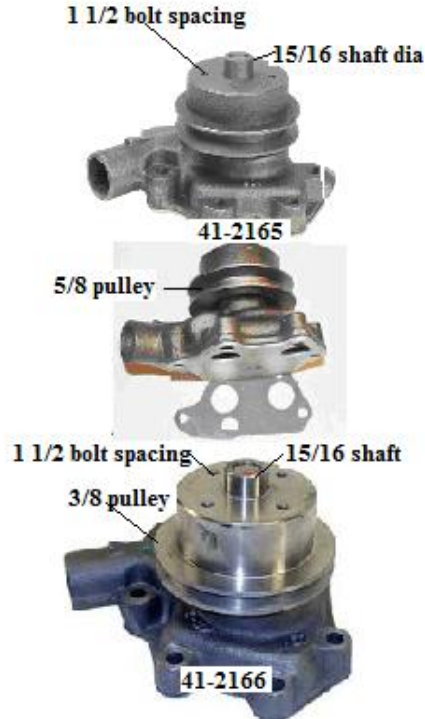

Bill's Truck Shop

Phone (905) 725-3460 / (905) 725-2022 / Fax (905) 404-2302 email: bill@billstruckshop.com

Used



Thermostat Housing-straight forward-angle V8

18-0453 used when installing V8 w/ OE type rad \$19.95

Hose-rad overflow drain 30" 3/8 thin walled-ribbed hose

10-00FH \$8.95

Radiator Overflow Bottle kit

41-2255 OE GM accessory w/ instructions 47-55 \$139.95

Heater Hose Clamps

41-0220 up to 1" wrap- screw type each \$0.95

41-0220-0 up to 1 " flat OE style each 36-59 \$3.25

Fan Belt

41-2FB-47 w/ 5/8 wide pulleys 47-52 \$32.95

41-2FB-47-A w/ 5/8 pulley & / alt- .53 wide x 41" long -runs lower in 5/8 wide crank & water pump & still fits new alt pulley 47-52 \$39.95

41-02FB-1 w/ 3/8 wide pulleys 37-54 \$24.95

41-03FB-2 GMC w/ 3/8 groove pulley 6 cyl 39-59 \$22.95

41-03FB-3 GMC w/ 5/8 groove pulley 6 cyl 39-59 \$29.95

41-03FB-4 GMC w/ 3/4 groove pulley 6 cyl 39-59 \$22.95

Fan Blade

41-FBL 216 or early 235 ci engine only- 1 " center shaft hole w/ 1 1/4 " pump bolt pattern 37-53 \$49.95 \$20.00

Water Pump-engine fittings

41-0058 5/8 hose fitting 1 1/2 ' long \$11.95

41-0034 3/4 hose fitting 1 1/2 ' long \$11.95

41-0034-L 3/4 hose fitting 2 1/2 ' long \$11.95

Ignition-Engine Parts

Due to the fluctuation of the Canadian and American dollars call for current prices

Group 41



		<u>Year</u>	<u>New</u>	<u>Used</u>
Distributor				
41-0D-235	235 CI engine/ plus	\$30-00	core charge if core is not useable	
	includes new cap, rotor, points, condensor	53-62	Inquire	
Distributor Vacuum Advance				
41-0DVA	6cyl	37-62	\$57.95	
Clips-vac & fuel				
41-0195	3 pcs set secures dist vac line to fuel line	37-62	\$12.95	
Dist Cap				
41-2DC-47	6 cyl dist cap 2 " high	33-53 Chev & 39-59 GMC	\$29.95	
41-02DC-53	6 cyl dist cap	53-62	\$45.95	
Dist Rotor				
41-2DR-47	6 cyl dist rotor	33-53 Chev & 39-59 GMC	\$18.95	
41-02DR-53	6 cyl dist rotor	53-62	\$19.95	
Ignitions Points w/Condenser				
41-02PC		41-62	\$39.95	
Ignition Resistor				
18-0203	reduces ignition from 12v to 9v	47-59	\$14.95	
Spark Plug Wire Set w/ sealed plug caps 7mm				
41-02PW-6	6 cyl	47-62	\$42.95	
41-02PW-6C	6 cyl correct carbon core (helps reduce radio static) "open metal ends" 90% @ spark plug' used on 216 (also can be used on the 235) w/ two rubber rings to secure wires in sets of three-correct for 35-53 but also will work on 54-55	35-53	\$49.95	
Delco Electronic Ignition-6V —delivers twice the voltage to the spark plugs-improves start-up-fuel mileage-performance—uses existing coil & dist				
41-0168-6	6cyl 6 volt neg ground	40-55	\$224.95	
Spark Plugs				
41-02SP-47	10 mm Chev only	41-48	\$6.00	
41-02SP-49	14 mm 6cyl	37-40 & 49-62 Chev-----39-59 GMC	\$5.95	
Ignition Coil				
41-2IC-6	6 volt		\$44.95	
41-02IC-12	12 volt		\$39.95	
Spark Plug Wire Tubing				
41-0710	chrome tubing for 216 / 235 w/ center bolt type valve cover	40-52	\$33.75	

Bill's Truck Shop

Phone (905) 725-3460 / (905) 725-2022 / Fax (905) 404-2302 email: bill@billstruckshop.com

Ignition-Engine Parts

Due to the fluctuation of the Canadian and American dollars call for current prices

Group 41

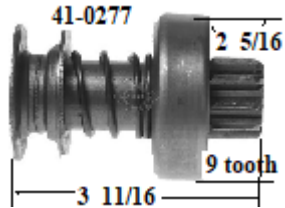
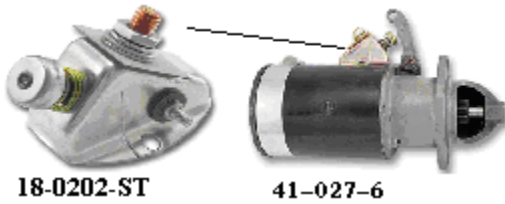

CORE CHARGE apply to starter & gen \$25.00

Starter-----REBUILT

		Year	New	Used
41-027-6	6 cyl , 6 volt w/ ft start	38-55	\$349.95	
41-027-12	6 cyl converted to 12V ft start	38-55	\$349.95	
41-027-12/6	6 cyl 12V starter converted to 6V for 55-62 235 engine—installed in 38-55 6 volt trucks	55-62	\$349.95	

Starter Switch -foot Start with side terminal

18-0202-ST	with side terminal for 12V ignition	38-59	\$32.95	
18-0202	w/ out side terminal w /6 volt	38-59	\$25.95	

Starter Drive

41-0277	9 tooth 2 5/16 width drive	38-55	\$79.95	
---------	----------------------------	-------	---------	--

Starter Brush set

41-0059		41-62	\$14.95	
---------	--	-------	---------	--

Generator-----confirm 3/8 OR 5/8 pulley and 5 1/2 " or 7 " case

41-0G-6V	6 volt	REBUILT	47-63	\$324.95
41-0G-12V	12 volt	REBUILT	47-63	\$295.00

Voltage Regulator-replacement ----neg ground

18-210-6	6v w/ screw on terminals	40-55	\$89.95	
18-0210-12-25	12 volt w/ 25 amp gen	47-62	\$69.95	
18-0210-12-35	12 volt w/ 35 amp gen	47-62	\$69.95	
18-0210-HK	OE style set of 3	47-62	\$1.95	

Alternator-SI 1 wire activates on RPM-NO voltage regulator required

19-0055	12 volt- 55 amp- NEW-requires 1 wire hook up may require turning housing for positive pin		\$159.95	
19-0033	female integral alt plug w/ terminals		\$7.95	
19-0044	6 volt (GM type 10S) 55 amp 3/8 belt pulley		\$199.00	
41-2FB-47-A	w/ 5/8 pulley & / alt- .53 wide x 41" long -runs lower in 5/8 wide crank & water pump & still fits new alt pulley	47-52	\$22.95	
19-0380	Replacement harness when adding SI alt	41-53	\$69.95	

Alternator Brackets w/ 6 cyl engine

41-2AB	37-55 Chev-GMC pickup & 51-54 pass car to convert from a gen to alternator-may require modification to adjust arm	37-55	\$99.95	
--------	---	-------	---------	--

Bill's Truck Shop

Phone (905) 725-3460 / (905) 725-2022 / Fax (905) 404-2302 email: bill@billstruckshop.com

Engine Parts

Due to the fluctuation of the Canadian and American dollars call for current prices

Group 41

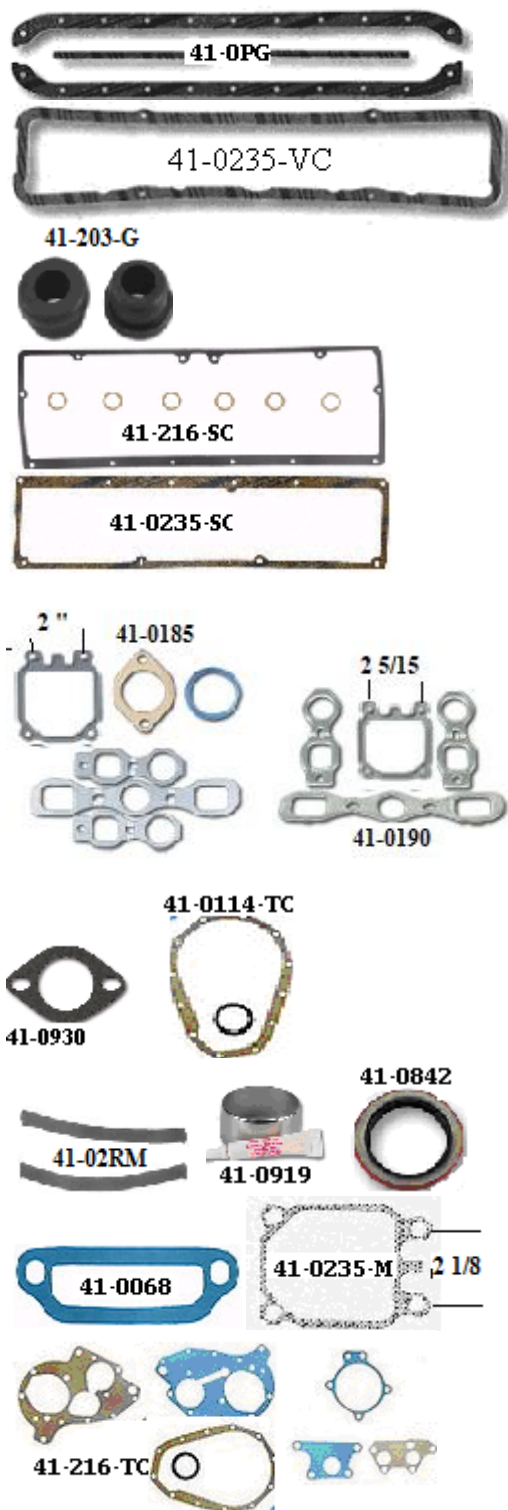

Oil Pan Gasket set

		<u>Year</u>	<u>New</u>	<u>Used</u>
41-0PG	37-53 -216/41-55 -235 engine	37-55	\$34.95	
41-0PG-55	235 engine	55-62	\$39.95	
41-0PG-GMC	228-236-248-270 6 Cyl GMC	39-59	\$24.95	

Rear Main Seal set

41-02RM	216-235-261 engine- NEW 2 pc rope	40-62	\$62.99	
41-02RM-B	216-235-261 engine OLD 2 pc rope	40-62	\$19.95	
41-02RM-A	216-235-261 engine- 2 pc new improved rubber style	40-62	Inquire	
41-02RM-GMC	2 pc rope seal 228-236-248-270-302	39-62	\$62.99	

Valve Cover Gasket

41-216-VC	216 engine w/ center bolts-see below	37-52	NLA	
41-0235-VC	fits both 216-235 w/ top or side mount bolts	37-62	\$34.95	
41-0228-VC	228/236/248/270/302 GMC 6 cyl	39-62	\$32.95	

Valve Cover Grommets

41-203-G	w/ 2 center bolts 34-53 Chev/39-59 GMC pair	34-59	\$4.00	
----------	---	-------	--------	--

Side Cover Gasket

41-216-SC	216 engine -push rod cover w/o-ring	37-52	\$43.95	
41-0235-SC	216-235 engine- push rod cover	53-62	\$24.95	
41-0228-SC	226-236-248-270 6 cyl GMC	39-59	\$25.95	

Timing Cover Gasket set 228/236/248/270-52-59-302

41-0114-TC		37-62	\$59.95	
------------	--	-------	---------	--

Timing Cover Crank Seal

41-0842	1 pc	37-62	\$27.95	
---------	------	-------	---------	--

Balancer Repair kit

41-0919	corrects groove-w/ sleeve 6 cyl-SB v8	47-87	\$29.95	
---------	---------------------------------------	-------	---------	--

Intake to Exhaust Manifold Gasket only-1 pc

41-216-M	216 engine 2 7/16	37-53	\$7.95	
41-0235-M	235 engine 2 1/8	53-62	\$7.95	

Intake & Exhaust Manifold to Head Gsk set

41-0190	includes between intake & exhaust ,pipe to manifold etc 216 engine-check inner stud spacing	37-50	\$39.95	
41-0185	includes between intake & exhaust ,pipe to manifold etc 235 engine check inner stud spacing	50-62	\$38.95	
41-0008	6 cyl 248-270 (50-51)/ 302 (52-59) GMC	50-59	\$28.95	

Thermostat Gasket

41-0930	all 6 or 8 cyl		\$3.95	
---------	----------------	--	--------	--

Thermostat Housing to Block Gasket

41-0068	216--235	37-62	\$3.50	
---------	----------	-------	--------	--

Bill's Truck Shop

Phone (905) 725-3460 / (905) 725-2022 / Fax (905) 404-2302 email: bill@billstruckshop.com

Engine Parts

Due to the fluctuation of the Canadian and American dollars call for current prices

Group 41

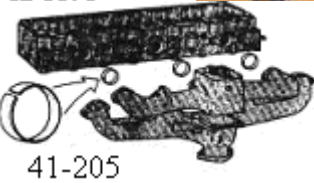
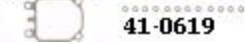
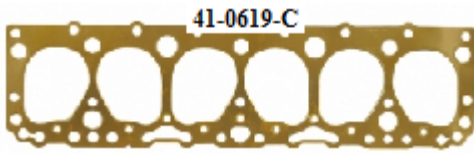

Head Gasket 235 6 cyl engine

41-0619-C NEW copper style-re-torque after running

Year New Used

53-63 \$84.95

Engine Valve Grind set-includes head-intake-exhaust-valve cover-push rod cover-oil pan-valve stem seals-thermostat-water outlet etc

41-0619 235 6 cyl 53-62 Inquire

Engine Rebuild Kit

41-2539 235 6 cyl 50-52 \$189.95

Water Pump to Block Gasket

41-0069 216 & 235 6 cyl 47-54 \$5.75

41-0069-53 235 6 cyl 55-62 \$5.75

Water Pump to Cover Plate Gasket

41-0070 216 & 235 6 cyl 47-55 \$4.00

41-0070-53 235 6 cyl 53-62 \$4.00

Fuel Pump Gasket

41-0075 6 & 8 cyl 47-86 \$3.00

Intake Manifold Alignment Sleeves

41-0205 34-53 207 & 216 Chev CI engine/41-49 235 Chev engine / 39-59 GMC engine ---- 34-53 approx 1 3/8 OD set of 3 38-59 \$11.95

41-0205-1 235 & 261 CI Chev engine approx 1 1/2 OD set of 3 50-62 \$11.95

Valve Cover Grommets

41-203-G w/ 2 center bolts pair 47-53 \$4.00

Valve Cover Nuts- Acorn style-stainless steel

41-203-N 34-53 Chev & 39-59 GMC pair 34-59 \$6.95

41-203-NS 34-53 Chev & 39-59 GMC steel/pair 34-59 \$2.50

Cam Gear-fibre type

41-0500 Cam Gear-216/228/235/248/270 42-62 \$84.95

Bill's Truck Shop

Phone (905) 725-3460 / (905) 725-2022 / Fax (905) 404-2302 email: bill@billstruckshop.com

Exhaust Parts

Due to the fluctuation of the Canadian and American dollars call for current prices

Group 41

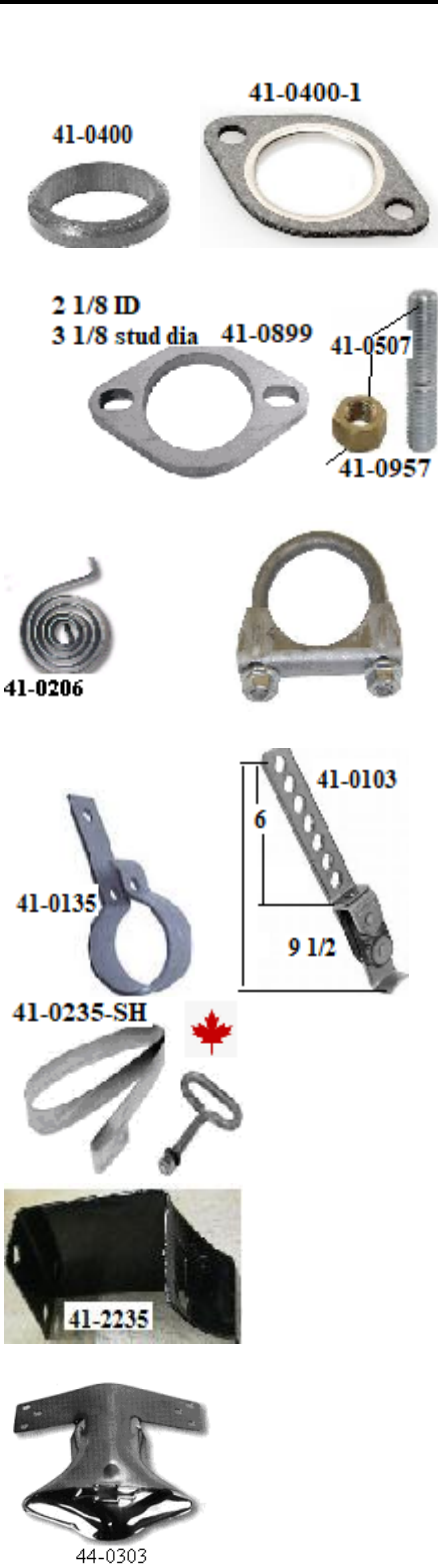

EXHAUST	Year	New	Used
Exhaust Manifold—inquire w/ casting #			
41-2E Chev-or GMC	47-55		\$125.00
Heat Riser Spring			
41-0206 6 cyl	37-65	\$32.95	
Exhaust pipe to manifold stud			
41-0507 one stud (3/8 x 2 1/2 long) w/ deep brass nut -- each		\$9.80	
41-0957 brass nut- style pr		\$4.95	
Exhaust pipe to manifold stud-oversize			
41-0507-OS 7/16 x 2 1/2-- to replace broken/drilled stud from manifold		\$5.75	
Exhaust Flange w/ 2" pipe			
41-0899 3 1/8 center to center on stud		\$15.95	
Exhaust Donut-w floating flange			
41-0400 ft pipe to manifold 2" ID		\$5.95	
Exhaust Gasket-some pipes w/ fixed flange bolt flat to manifold 2 15/16 approx stud spacing			
41-0400-1 ft pipe to manifold flat gasket		\$3.00	
Exhaust Clamp			
41-0115 1 1/2 "		\$2.25	
41-0134 1 3/4 "		\$2.50	
41-0020 2 "		\$2.50	
41-0218 2 1/8 "		\$2.50	
41-0025 2 1/4 "		\$4.45	
Muffler-Frame Bracket			
41-2235	47-55	\$24.95	
Muffler Strap w/ hook			
41-0235-SH	40-59	\$14.95	
Muffler Strap			
41-0235-S satin coated steel 20 " long	40-59	\$8.95	
Tailpipe Hanger			
41-0135	47-59	\$19.95	
Universal Exhaust Hanger			
41-0103		\$17.50	
Exhaust Deflector			
44-0303 stainless steel w/ Chev logo		\$34.95	

Bill's Truck Shop

Phone (905) 725-3460 / (905) 725-2022 / Fax (905) 404-2302 email: bill@billstruckshop.com

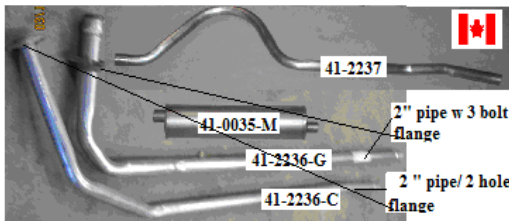

**Front Pipe—for short bed –see ext for long bed-
---galvanized pipe**

41-2236-C	2"pipe 6 cyl Chev w/ 2 hole flange	47-55	\$189.95
41-02236-G	2" pipe 6 cyl GMC w/ 3 hole flange	47-55	\$169.95

Tailpipe

41-2237	1 3/4 pipe 6 cyl Chev & GMC w/ turn down end to exit below rear bumper on short step & behind bumper on long beds	47-55	\$159.95
41-2237-L	2 "extension pipe for 8 and 9 ft beds to exit tailpipe below rear cross sill cut to fit application	47-55	\$59.95

Muffler

41-0035-M	21"L x 5"W accepts 2" inlet pipe & 1 3/4 outlet pipe-----ID spec	40-59	\$89.95
-----------	--	-------	---------

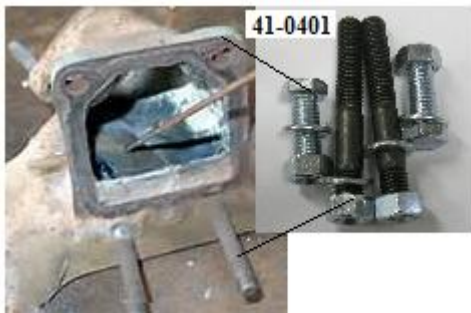

Exhaust to Intake bolt kit

41-0401	2 bolts (1 ¼) & 2 studs (3 ¼) w/ hdw		\$9.95
---------	--	--	--------

Bill's Truck Shop

Phone (905) 725-3460 / (905) 725-2022 / Fax (905) 404-2302 email: bill@billstruckshop.com

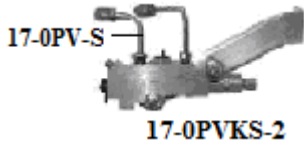

Proportioning Valves

17-0PVKS-2 \$149.95
 Brake Proportioning Valve -disc/drum w/ lines-when
 converting to disc front **Brass**

17-0PVKS-4 \$149.95
 Brake Proportioning Valve -disc/disc w/ lines-when
 converting to disc front and rear **Brass**

17-0PVKS-A4
 Brake proportioning valve-disc-disc & disc drum
 w/ lines & bucket \$159.95

17-0PVK-H
 Replacement harness w/ socket \$19.95

Disc Brake kit

47-59-5 **lug disc brake kit**—uses stock 1/2 spindles & hubs
 Kit includes rotors, 5x 4 3/4 bolt pattern--- calipers,
 brackets, flex hoses and hardware Bearing upgrade(tapered
 roller w/ seals) may not work with stock wheels-1947-49
 may require re-drilling lower spindle holes from 7/16 to 1/2
 45-0WBK-5 47-59 \$659.95

47-59 **6 lug disc brake kit**—uses stock 1/2 spindles &
 hubs.Kit-includes rotors, callipers, brackets, flex hoses and
 hardware Bearing upgrade(tapered roller w/ seals) is
 recommended-may not work with stock wheels-47-49 may
 require re-drilling lower spindles holes from 7/16 to 1/2 “
 45-0WBK-6 47-59 \$799.95

Wheel Bearings kit-upgrades to tapered roller

bearings w/ grease seals 1/2 ton only
 38-04759-BK 47-59 \$189.95
 38-04759-S replacement grease seal each 47-59 \$12.95

47-59 Disc brake upgrade bkt kit 47-59 \$174.95

45-0DBK-5
 5 x 4 3/4 bolt pattern-add callipers, 11”, rotors w/ bearing upgrade
 kit, brackets, flex hoses and hardware-bolts to stock spindles.
 Converts your straight axle to disc brakes-used factory holes on 1/2
 ton spindle-kit includes calliper brackets, bearing adaptors &
 hdw-used 70-77 Camaro rotors & callipers--will also have to
 upgrade to dual master & prop valve

17-0BR13	Inner wheel bearing	each	\$16.95
17-0BR49	Outer wheel bearing	each	\$12.95
17-0BR2	Outer wheel bearing	each	\$12.95
17-0984	grease seal	each	\$5.95

Phone (905) 725-3460 / (905) 725-2022 / Fax (905) 404-2302 email: bill@billstruckshop.com



36-0PCH



17-0BV-B



45-0RPV-2

Intake Vacuum Port

17-0VP-1	1 port hose fitting - 3/8" intake hole- for power brakes	\$29.95
17-0VP-2		\$29.95

Brake Booster & PCV Hose

Hose-booster vac w/clamps-OE style 3/8" 40" long w/ curved end	\$18.95
--	---------

Brake Booster Check Valve w/ Grommet

17-0BV-B	black	\$15.95
----------	-------	---------

Universal brake booster

45-0DD8	8" dual diaphragm zinc plated	\$189.95
---------	-------------------------------	----------

Residual pressure valve-

Inlet & outlet-3/8-24 inverted flare

45-0RPV-2	2 lb disc brakes	\$15.95
45-0RPV-10	10 lb drum brakes	\$15.95

Phone (905) 725-3460 / (905) 725-2022 / Fax (905) 404-2302 email: bill@billstruckshop.com

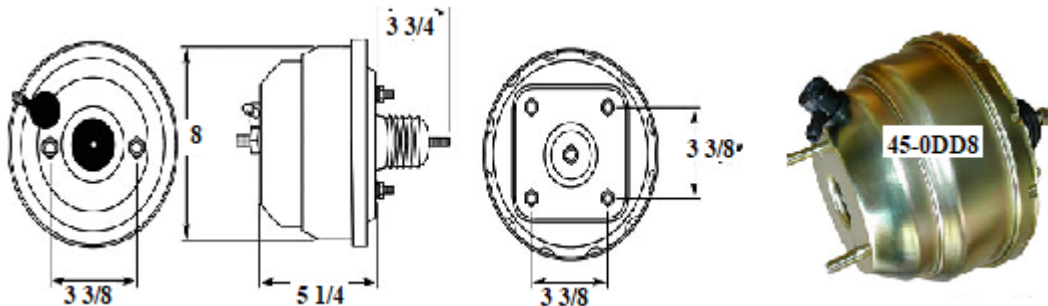

Ever had problems with a spongy pedal or slow, unresponsive brakes? If so, you may need a residual pressure valve installed in your brake line. A residual valve acts like a one-way or check valve to maintain brake system pressure to eliminate the problems of a spongy pedal. This 2 PSI residual valve is installed in line between the master cylinder and disc brake calipers to keep 2 PSI of residual pressure at the caliper after the brake pedal is released. This ensures that you will have a high, firm pedal next time you press the brake pedal.

If your master cylinder is located below the floorboard, installing a 2 PSI residual valve is highly recommended. If your master cylinder is mounted on the fire wall, a residual valve is generally not needed because gravity will provide a natural residual pressure within the brake line.

Hold 10 lb of line pressure at all times- Keeps wheel cylinder cups expanded and ready to move

For use in brake line supplying drum brakes- Should be mounted as close to the master cylinder



42-2SM-4



		<u>Year</u>	<u>New</u>
Shop Manual Exact reprints of the original factory shop manuals, Includes data, specifications, capacities, wiring diagrams, etc – <i>supp year requires previous year</i> .			
42-2SM-8	Chevrolet	47-53	\$29.95
42-2SM-4	Chevrolet	54-54	\$29.95
42-2SM-5	Chevrolet	1955 Supplement	\$14.95
42-2SM-G	GMC	47-54	\$29.95
Owners Manual With GM plastic folder.			
Chevrolet			
42-247-48C		1947-48	\$22.95
42-249C		1949	\$22.95
42-250C		1950	\$22.95
42-251C		1951	\$22.95
42-252C		1952	\$22.95
42-253C		1953	\$22.95
42-254C		1954	\$22.95
42-255C	1st series	1955	\$22.95
GMC w/o bag			
42-247-48G		1947-48	\$17.95
42-249G		1949	\$17.95
42-250G		1950	\$17.95
42-251G		1951	\$17.95
42-252G		1952	\$17.95
42-253G		1953	\$17.95
42-254G		1954	\$17.95
42-255G	1st series	1955	\$17.95
Accessory List & Price Schedule Helps to identify NOS accessory parts for your year & model.			
42-247A		1947	\$5.25
42-248A		1948	\$5.25
42-249A		1949	\$5.25
42-250A		1950	\$5.25
42-251A		1951	\$5.25
42-252A		1952	\$5.25
42-253A		1953	\$5.25
42-254A		1954	\$5.25
Radio-Service &Shop manual			
42-2RM		47-53	\$9.95

Bill's Truck Shop

Phone (905) 725-3460 / (905) 725-2022 / Fax (905) 404-2302 email: bill@billstruckshop.com



Accessory Installation Manual Detailed illustrations of all accessories and explains how they are installed. *for passenger cars and trucks*

	<u>Year</u>	<u>New</u>
42-249M	1949	\$10.00
42-251M	1951	\$10.00



42-2FAM



42-2CID

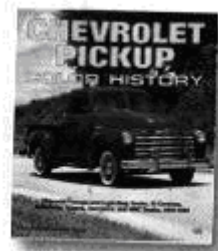

42-0CHB

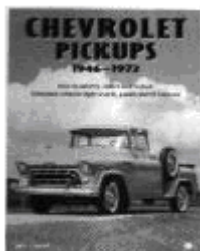

42-0THB

Factory Assembly Manual Exploded views of the assembly of the trucks. Pertains to all years and GMC also.

42-2FAM	47-54	\$44.95
---------	-------	---------

Truck History Book A large collection of information on 1946-1972 Chevy Trucks. Loaded with photos and specifications.

42-2THB	46-72	\$27.50
---------	-------	---------

Catalogue of Chevy Truck ID Numbers Includes VIN's body numbers, engine numbers, trim and paint codes, and more.

42-2CID	46-72	\$24.95
---------	-------	---------

Chevrolet Pickup Colour History Book History on Chevy pickups from 1918-1984 with photos.

42-0CHB	18-84	\$27.50
---------	-------	---------

Transmission Overhaul Manual - 3 Speed Reprint of the original GM book.

42-2TM	48-54	\$7.95
--------	-------	--------

Rear Axle Overhaul Manual A manual for rebuilding the closed type rear end.

42-2AM	47-55	\$7.95
--------	-------	--------

Wiring Diagrams

42-2WD-47	47-53	\$5.00
-----------	-------	--------

42-2WD-54 and 1 st 55	54-55	\$5.00
-----------------------	-------	--------

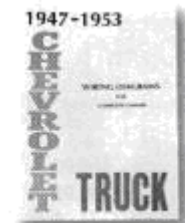

42-2WD

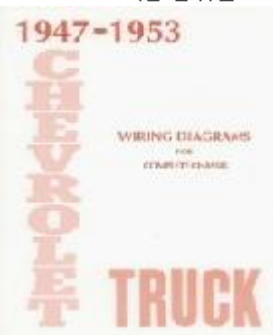
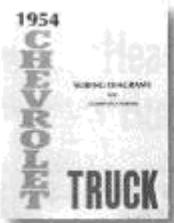









Bill's Truck Shop

Phone (905) 725-3460 / (905) 725-2022 / Fax (905) 404-2302 email: bill@billstruckshop.com

Accessories

Group 44

			<u>Year</u>	<u>New</u>
 44-0303	44-030 	Exhaust Deflector –stainless steel		
	44-0303 w/ Chevy logo	each		\$34.95
 44-2L54	 44-028	Licence Plate Frame-chrome w/ blue details-year at top w/ CHEVROLET at bottom.	each	
		44-2L47	47-47	\$14.95
		44-2L48	48-48	\$14.95
		44-2L49	49-49	\$14.95
		44-2L50	50-50	\$14.95
		44-2L51	51-51	\$14.95
		44-2L52	52-52	\$14.95
		44-2L53	53-53	\$14.95
		44-2L54	54-54	\$14.95
		44-2L55	55-55	\$14.95
 44-009		License Plate Fasteners		
 44-006	 44-007	44-028 set of 4 chrome bullets		\$4.95
		44-029 stainless steel carriage bolts w/ hdw	set of 4	\$3.25
		44-030 4 nylon nuts w/ w screws		\$4.95
		Headlight Half Moon –chrome		
		44-009 for 7 ½ “ lights	pair	\$29.95
		Headlight Cat-Eye Cover -chrome		
		44-006 for 7 ½ “ lights	pair	\$14.95
 44-0SE	 44-0TV	Headlight Visors		
		44-007 stainless steel for 7 ½ light	pair	\$29.95
		Streetrod Emblem		
		44-0SE chrome	each	\$9.50
 44-2150		Traffic Light Viewer Repro of factory accessory.		
		44-0TV	47-59	\$86.95
		Door Vent Shades Original GM option (pair)		
		44-2150 Stainless steel pair	51-55	\$49.95
 13-210		Door Drip Shield – pr		
		13-210 secured on door	pr 47-55	\$30.00

Bill's Truck Shop

Phone (905) 725-3460 / (905) 725-2022 / Fax (905) 404-2302 email: bill@billstruckshop.com

EXTERIOR SUN VISORS

Group 44



44-0SV-1 Chevy-Pontiac-Olds 2 & 4 dr sedan,coupe,wagon w/ 2pc windshield universal fit-steel/black metal w/stainless trim

<u>Year</u>	<u>New</u>	<u>Used</u>
49-52	\$724.95	



Outside Sun Visor-a beautiful reproduction of the Fulton 800 style-w/ all hardware and instruction-for split windshields

44-2SV **steel/ black** adjustable-will fit Chev-Ford-Dodge-Plymouth cars & trucks w/ split windshield

37-53	\$699.95	
-------	----------	--

44-2SV-A **aluminum/green** adjustable

47-53 Chev-GMC truck / 41-48 pass car & wagon

47-53	NLA	
-------	-----	--



44-2SU-S stainless steel long & short center supports for Fulton visors pair

37-53	\$64.95	
-------	---------	--

44-2SB-L outer left side (dog bone) support

37-53	\$114.95	
-------	----------	--

44-2SB-R outer right side (dog bone) support

37-53	\$114.95	
-------	----------	--

44-2S-VR center adjust rods w/ hdw pair

37-53	\$99.95	
-------	---------	--

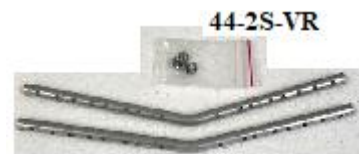

]

Bill's Truck Shop

Phone (905) 725-3460 / (905) 725-2022 / Fax (905) 404-2302 email: bill@billstruckshop.com

EXTERIOR SUN VISORS

Group 44

Year New Used



44-2SV-54

Outside Sun Visor-a beautiful reproduction of the Original GM accessory-w/ all hardware and instruction

54-55

\$699.95



44-2SB-54 outside visor (1pc) supports-pr

54-55

\$119.95



Bill's Truck Shop

Phone (905) 725-3460 / (905) 725-2022 / Fax (905) 404-2302 email: bill@billstruckshop.com

PERFORMANCE ACCESSORIES



Rad Overflow Tank

44-0255-15 15 " polished stainless steel
44-0255-13 13 " polished stainless steel

44-0PVC Gas pedal w/chrome vertical bars, rubber insert, spring loaded, adjustable arm & L or R mount

44-0TBS Accel bkt @ carb w/ return springs stainless steel

44-0TBS-1 Accel bkt @ engine w/ return springs- stainless steel

44-0TBS-2 Throttle cable bkt w/ 350/400 kickdown adapt stainless steel

7-0007 Accel spring set

Adjustable Throttle Cables

44-0TC-24 24 ' long/black coating
44-0TC-24-SS 24" long/stainless steel

Pedal support/Pad

45-0213

Truck Covers- we recommend *Hugger Covers*
@ 905-857-1800 or www.huggercovers.com--also a Canadian company-great product w/ great service

Year New Used

universal \$84.95

Universal \$79.95

universal \$89.95

universal \$24.95

universal \$19.95

universal \$29.95

universal \$9.95

universal \$29.95

universal \$44.95

\$29.95

Bill's Truck Shop

Phone (905) 725-3460 / (905) 725-2022 / Fax (905) 404-2302 email: bill@billstruckshop.com

STEERING UPGRADES



Column Saver kit allows reusing the original column w/ Mustang II front ends or any other replacement steering box-installs housing w/ bearing in original column-complete w/ instructions

Year New Used

40-0175BCS 47-59 GM trucks & cars w/ 1 3/4" column 47-59 \$144.95

40-0150BCS GM w/ 1 1/2" column 47-59 \$89.95

40-0150BCS-A GM trucks & cars w/ 1 1/2" column w/ 3/4" x 3/4" DD U-joint & stub shaft 47-59 \$134.95

Column Steering Shaft extension 3/4" DD shaft when extending from column to steering rack or box

40-1850-DD-BO -black oxide 18" \$56.95

40-1850-DDN nickel plated 18" \$59.95

40-0024 STEEL 24" \$69.95

40-3650-DD unplated steel 36" \$69.95

40-3650-DD-NP nickel plated 36" \$83.95

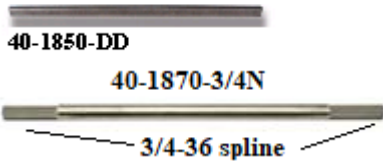

40-1870-3/4N nickel plated 3/4" round x 36 spline 24" long \$69.95



Collapsible Steering Shaft

40-0626-AD 1" DD to 3/4" DD Adjustable steering shaft 16" to 26" nickel plated \$119.95

40-0636-AD 1" DD to 3/4" DD Adjustable steering shaft 24" to 35" nickel plated \$129.95



Intermediate Shaft & Flange

40-00SF 9 1/4" w/ rag joint flange -accepts 3/4" DD shaft w/ dust boot- **operates as a collapsible safety shaft** \$39.95

40-00SR 4" long 3/4" round input end w/rag joint flange end-drill & pin to column shaft (recommend welding tube to shaft) \$34.95



Bill's Truck Shop

Phone (905) 725-3460 / (905) 725-2022 / Fax (905) 404-2302 email: bill@billstruckshop.com

STEERING UPGRADES

Year New Used

Steering Shaft –u-joint when joining new columns to new steering systems (eg 3/4-30 spline to double D shaft)
 CNC machined Billet Steel- **always drill a dimple in shaft where set screw seats**



41-0DUJ32



41-0UJ7



41-0UJ3

41-0UJ1	9/16-26 x 3/4-DD (mustang manual rack)	\$109.95
41-0UJ3	3/4-30 x3/4-DD	\$109.95
41-0UJ4	3/4 -36 x 3/4 - 36	\$109.95
41-0UJ5	3/4-36 x 3/4-DD (mustang power rack)	\$109.95
41-0UJ6	3/4-DD x3/4-DD	\$109.95
41-0UJ7	3/4 DD x 1-DD	\$109.95
41-0UJ9	13/16-36 x 3/4-DD	\$109.95
41-0UJ16	3/4-DD x 3/4 smooth	\$109.95
41-0UJ17	3/4 DD x 17MM	\$109.95
41-0UJ18	3/4- 36 x 1-DD	\$109.95
41-0UJ24	3/4-30 x 1-DD	\$109.95
41-0UJ26	1DD x 1-DD	\$109.95
41-00SS	3/4 steering shaft support	\$39.95

Double Steering u-joint

41-0DUJ6	3/4DD x 3/4DD	\$204.95
41-0DUJ32	3/4-36 x 3/4 -DD	\$204.95
41-0DUJ98	1" DD x 3/4 DD	\$204.95

Steering Shaft Support

41-00SS	3/4 steering shaft support	\$38.95
---------	----------------------------	---------







41-00SS

Bill's Truck Shop

Phone (905) 725-3460 / (905) 725-2022 / Fax (905) 404-2302 email: bill@billstruckshop.com

STEERING UPGRADES

		<u>Year</u>	<u>NEW</u>	<u>Used</u>
 	Steering Rag Joint			
	41-0RJ30	1"DD x 3/4 -30 spline		\$134.95
	41-0RJ36	3/4 -36 x 11/16 -36		\$134.95
	41-0RJ36-3/4DD	3/4"DD x 11/16 -36 spline		\$134.95
	41-0RJ366-3/4DD	3/4 DD x 3/4-36 spline		\$134.95
	41-0RJ36-1DD	1"DD x 3/4 -36 spline		\$134.95
	41-0RJ366-1DD	1DD x 11/16 -36 spline		\$134.95
	41-0RJ10	1"DD x 3/4" DD		\$134.95
	Steering Rag Joint (mini 2 7/8 OD)			
	41-0RJ24-M	1"DD x 3/4 30 spline		\$114.95
41-0605S	3/4 DD x 3/4 30 spline x 3/4 round- includes drift pin		\$114.95	
41-060				
Steering Shaft Coupler				
41-0SC36	3/4 DD x 3/4 x 36		\$75.00	
	Power Rack Control Valve w/ adapt fitting			
	45-0PSCV	when using early power steering pumps on mustang steering rack—reduces amount of fluid flow		\$24.95
	41-060			
	Power Steering Pump Bkt kit- fits small block Chev w/ long or short neck water pump-will require additional crank pulley			
	15-0301			\$94.95
GM power steering pump bracket kit-fit early 216 & 235 engine 1947-1962-pump not included				
41-0PSK-216		47-50	\$299.95	
41-0PSK-235		50-62	\$299.95	
These brackets require the use of an alternator and will not work with a factory generator. Complete bolt on assembly- requires a double pulley on power steering pump				

Bill's Truck Shop

Phone (905) 725-3460 / (905) 725-2022 / Fax (905) 404-2302 email: bill@billstruckshop.com

STEERING UPGRADES

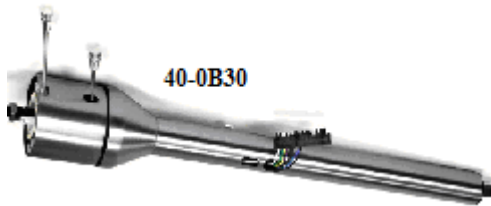

40-0B30

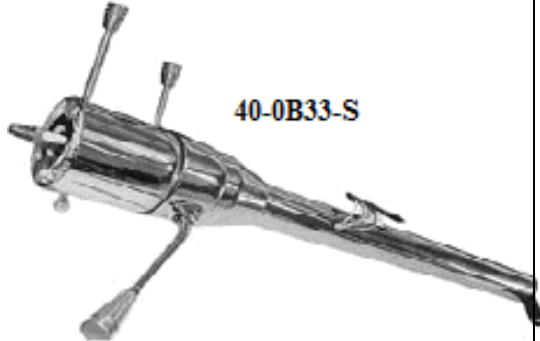

40-0B33-S



3-0010-3

40-0CS-2x2.5



40-0LCS



40-0LCS-2

40-0LCS-4



IDIDIT Steering Columns

Year New Used

Includes dash & firewall support-4 way flasher-self cancelling signals-1"DD output shaft-8 position tilt-w/shift has NO neutral safety switch US made includes dash mount and floor support 2.5 shaft OD

40-2754-ATB	auto w/ tilt-black	47-55	Inquire
40-2754-TB	no shift-tilt-black	47-55	Inquire

Tilt Columns-w/ new style GM signal switch
NO P/N-rev switch

UNIVERSAL APPLICATION

Includes shift levers & indicator w/ shift-use your OE support -add support bushing # 5-0316 & lower column seal #7-308-4

40-0B33-S	Tilt Column-33"/black -auto-1" DD shaft	\$699.95
40-0B32	Tilt column-32"/black-no shift/1"DD shaft	\$699.95
40-0B32-S	Tilt Column-32"/black - auto -1" DD shaft	\$699.95
40-0B30	Tilt Column-30"/black- no shift /1"DD shaft	\$699.95
40-0B30-S	Tilt Column-30"/black -auto-1" DD shaft	\$699.95
40-0B33-S	Tilt column-33" /black w/ aut 1" DD shaft	\$699.95

Shift Indicator-required on all columns acrylic-stick on

3-0010-3	w/3 speed auto	\$44.95
3-0010-4	w/4 speed auto	\$44.95

Upper Column Support w/ 2" tube

40-0CS-2x2.5	polished aluminum	47-59	\$79.95
--------------	-------------------	-------	---------

Lower Column Support

40-0LCS-2	w/ 2" shaft and boot	\$149.95
40-0LCS	swivel polished w/ 2" shaft	\$104.95
40-0LCS-4	adjustable swivel 2" shaft	\$63.95

Bill's Truck Shop

Phone (905) 725-3460 / (905) 725-2022 / Fax (905) 404-2302 email: bill@billstruckshop.com

STEERING UPGRADES

Year New Used

REPLACEMENT STEERING WHEELS

Steering Wheel-comfort grip-black includes mounting hub-Chev horn cap-horn contact plate and mounting screws

\$329.95

5-5625 Classic GM styled brushed stainless steel 3-spoke steering wheel with black cushioned grip. Includes chrome horn button with Chevrolet Bowtie. 15 inches diameter with 4 1/2" dish.

5-5625-P Horn Contact Plate w/ comfort steering wheel

\$35.50

5-5625-H Hub-steering wheel mounting

\$54.95

5-5625-C Cap-horn cap-Chev black/red/white details

\$45.95

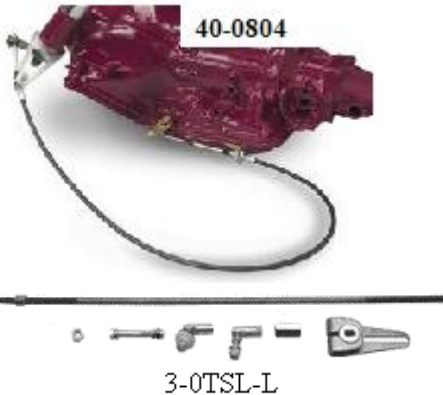
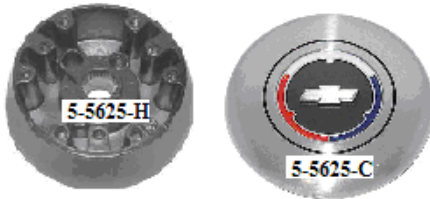

40-0804

Transmission shift kit –GM 2 “ column mount/ 6’ cable w/all bkts & hdw--- TH350, TH400, 700-R4, TH200, 200-R4, 4L60 and 4L80E

\$249.95

Automatic Shift Linkage kit-universal linkage from column bracket to trans-used on installation of newer columns - stainless steel

3-0TSL-L

\$94.95

Bill's Truck Shop

Phone (905) 725-3460 / (905) 725-2022 / Fax (905) 404-2302 email: bill@billstruckshop.com

PERFORMANCE UPGRADES



Year New Used

19-0412
Torque Converter Lockup Kit, Pressure Switch, In-line Fuse, GM, 200-4R, 700R4, Kit

\$129
 .95



Power Steering Pulley

15-0508 Double pulley/nut on-replaces GM 3941107
 15-0810 single groove-press on-back spaced-replaces GM 3834720

\$59.95
 \$59.95

Water Pump Pulley

50-0155 5.5" in w/6" outer double pulley @ water pump
 2 ¼ hole spacing replaces GM # 14023155
 50-0142 6" double pulley -w/ short neck water pump w/
 1 ¾ hole spacing replaces GM # 3995642

\$129.95
 \$94.95

Phone (905) 725-3460 / (905) 725-2022 / Fax (905) 404-2302 email: bill@billstruckshop.com

PERFORMANCE UPGRADES

Year New Used



V8 Crossmember.

40-0220 Adapts GM small block motors to early truck frames 47-59 \$94.95

V8 Motor Mount Use with V8 Crossmember,

40-0220-M OE rubber style \$21.95

40-0220-MP polyurethane w/zinc frame each \$64.95

Transmission Cross member Use to install standard or automatic transmissions

40-0225 47-59 \$94.95

Rear Transmission Mount Pad

14-025 use with std / PG / 350/700 trans \$24.95

14-025-1 turbo 400 \$24.95

Phone (905) 725-3460 / (905) 725-2022 / Fax (905) 404-2302 email: bill@billstruckshop.com



Power steering pitman arm when converting to power steering box
 45-0759PA-PS standard height \$79.75
 45-0759PA-PR reversed for lowered trucks \$74.75

I



update your existing axle to any 3-inch diameter rear end. This kit also contains provisions for modern shock absorber mounting-welding required
 47-54 Rear Axle Conversion kit
 45-24RCK \$199.95
 45-24RAS axle seat only pair \$21.95



1947-54 Chevy Pickup Truck 4-Link Suspension Kit, Complete

45-24LINK-----\$1895.00

1947-54 Chevy & GMC----- Lowers your truck 4-6"

- Truck and GMC Truck coil-over 4-link rear suspension provides the best ride for any Classic truck. These 4-link kits attach directly to the stock frame rails and the adjustable axle brackets let you set the height in one of three positions. A bolt-in upper coil-over crossmember is included. All brackets are made from 1018 mild steel. Our 4-link bars are double adjustable and made from DOM tubing. The double adjustable feature not only allows for precise rear end positioning, but allows you to adjust your pinion angle as well-plain steel items require welding

INCLUDES

- Upper Shock Crossmember (Black Powder Coated)
- Frame Brackets (Black Powder Coated)
- Axle Mount Brackets (Plain steel)
- Panhard Bar (Weld On, Zinc Coated Bar, Plain Brackets)
- 4 Bars Set (Zinc Coated)
- Coil-over Shocks (Aldan American)
- All hardware



47-55 Frame **mount brake booster**-bolts in the stock location-- includes 7" dual diaphragm booster, master cylinder, proportioning valve, mount bracket w/pedal & hardware-disc/ drum application-brake lines will need modifying—**for auto trans application-standard trans may require modification**

45-2BBD-8D drum-drum application -no prop valve required \$519.95

45-2BBD-8S disc-disc & disc-drum application when using **original brake pedal** \$624.95



47-55 Firewall **mount brake booster**-bolts in the stock location using supplied pedal-includes 8" dual diaphragm booster, master cylinder, proportioning valve, mount bracket w/ hardware

1947-1953

45-23FBB drum – drum application \$519.95
 45-23FBB2 disc-disc & disc- drum application \$624.95

45-23FB Firewall brake bracket kit w/ pedal \$269.95

1954-1955

45-23FBB2-54 disc – drum application Inquire
 45-23FBB2-54-4 disc – disc application Inquire
 45-23FBB-54 drum – drum application Inquire



HARDWARE

49-0610	5 /16-18 x 7/8 w/11/16 floating washer-NC	each	\$0.90
49-0612	5/16-18 x 1 w /7/8 floating washer-NC	each	\$1.15
49-0613	5/16 -18 x 3/4 w/ washer head -NC	each	\$1.15
49-0614	3/8-16 x 1 w/ 1 floating washer-NC	each	\$1.80
49-0615	3/8 -16 x1 1/2 w/ 1 1/8 floating washer NC	each	\$1.90

49-0620	5/16 -18 x 3/4 w/ OE style washer head	each	\$0.70
49-0621	5/16 -18 x1 1/16 dog point w/ floating washer-each		\$1.75

49-0710	5/16 – 18 U – nut	each	\$0.99
---------	-------------------	------	--------

49-0124	1/2 External tooth lock washer -flywheel bolts	each	\$0.30
---------	--	------	--------

BODY ALIGNMENT SHIMS -galvanized steel

20-000D	1/16 w/ 3/8 slot shim	each	\$1.25
20-000E	1/8 w/ 3/8 slot shim	each	\$1.25
20-000K	8 pc Shim kit 4 x 1/16 and 4 x 1/8	set of 8	\$9.95

Totally Stainless bolt kits

Every Body Kit includes component kits-for Front Bumper, Door Hinges, Door Latch & Catch, Fender to Firewall Brace Rods, Front & Inner Fenders, Grill & Gravel Pan, Headlight & Parking Lens, Hood Hinges, Hood Latch, Catch & Braces, Interior, Outside

Mirror, Radiator Support, and Regulator & Relay.

47-51	Chev -Body Bolt kit- 18-8 stainless steel w/ indented hex bolts-OE style/cab forward	does not include bed any bed hdw	\$319.95
-------	--	----------------------------------	----------

49-2383	52-53 Chev -Body Bolt kit- 18-8 stainless steel w/ indented hex bolts-OE style /cab forward	does not include bed any bed hdw	\$319.95
---------	---	----------------------------------	----------



Bill's Truck Shop

Phone (905) 725-3460 / Fax (905) 725-2022 / email: bill@billtruckshop.com

