

GENERAL INFORMATION

Ordering Information: Please make sure you are ordering the correct parts. Verify part numbers upon ordering. On larger orders please fax (905) 404-2302, email at mike@billstruckshop.com / rob@billstruckshop.com / aaron@billstruckshop.com or call for more information.

Payment: We accept VISA, MasterCard, Money Orders, E-Transfers, Personal and Company cheques. Payment plans also available on large restoration. Applicable taxes apply to all sales.

Shipping: Ship by your choice of Canpar, UPS, FedEx, Canada Post, or truck carrier on some large items. Most orders can be shipped same day for next business day delivery. Actual shipping charges will be applied. Also, a \$10.00 COD surcharge applies.

Pricing: Prices are in Canadian currency. Due to constant fluctuation between the Canadian and U.S. dollar –refer to the prices in the catalogues as a **GUIDE ONLY!** Bill's Truck Shop Limited Ltd., reserves the right to make appropriate changes as necessary. We try to keep prices low by keeping a large inventory on hand at all times. WE never buy parts with YOUR money to sell to YOU so we never pre-charge you for normal stocking items that are out of stock.

Returns and Guarantees: If fault is found in the parts or workmanship of item purchased, full money back guarantee or exchange for new item. If fault occurs from installation or misuse, no return will be given. No refunds will be given on electrical components or literature. Call with any questions.

Back Orders: No shipping charges will be applied to regular stocked items, unless a manufacturer's back order applies. All back orders cancelled after 60 days.

Discounts: Business's may apply for discounts after providing valid business info. Regular customer discounts can be applied depending on volume purchases / monthly specials and payment type. (E.g.: 3% discount on cash sales - on applicable items only) Check our website for monthly specials.

Parts: There is an ever increasing supply of reproduction parts, they are not always listed in the catalogues. New items can be viewed on our website, www.billstruckshop.com or call for info.

Used Parts: Unlike many other parts suppliers we stock or locate many parts that are not reproduced. We import parts from (California) and bring back trucks, beds, cabs etc. Bill's Truck Shop Limited has made a commitment to supply many new and used parts for your restoration and as a result we are the largest truck part supplier in Canada. NO discounts on used parts. We also will take your used parts in on trade.

Hours of Operation:

Monday to Friday 8:00am to 5:00pm EST

Saturday 9:00am to 3:00pm – Confirm by appointment

Sunday and holidays –Closed

NOTE: IF DRIVING LONG DISTANCE TO VIEW OUR INVENTORY, PLEASE CALL AHEAD!

Cab & Door Weatherstrip

Due to the fluctuation of the Canadian and American dollars call for current prices

Group 1

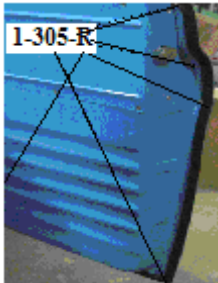
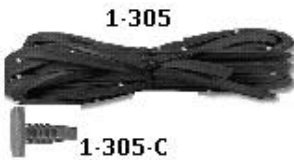
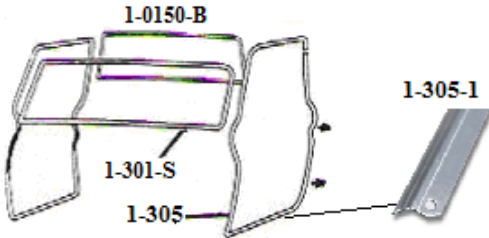

Windshield Weatherstrip

		Year	New
1-301-S	standard-does not accept trim	55-59	\$74.95
1-301-D	deluxe - accepts trim	55-59	\$79.95

Rear Glass Weatherstrip

1-0150-B	w/ black lock strip	47-66	\$49.95
1-0150-C	w/ chrome lock strip	47-66	\$59.95
1-05561-BB	big window w/ black lock	55-66	\$79.95
1-05561-BC	big window w/ chrome lock strip	55-66	\$99.95

Chrome Lock Strip per ft 7/16 W x 7/32W

1-0500	replacement-sold per ft	47-66	\$3.00
--------	-------------------------	-------	--------

Door Rubber Seals (pair)

1-305	w/ nylon clips, square corners-may require to relocate pin holes in door or seal	55-59	\$94.95
1-305-P	panel/suburban rear doors -OE moulded corners w/ steel retainers & nylon clips	55-59	\$269.95
1-0205-R	universal rear door seals-glue on-pair	36-66	\$39.95

Door Seal Retainers-# of retainers clips vary from 55-59 & Canadian / US and series size trucks-some also had another @ door front @ rear

1-305-R	metal clips at curve next to handle @ both lower corners 5 w/ screws/per door	55-59	\$10.95
1-305-C	nylon clips set of 10	55-59	\$11.95

Lower Door Seal Retainer (each)

1-305-1	steel	55-59	\$16.95
1-305-1SS	stainless steel	55-59	\$28.95

Retainer Screw Kit (16) -2drs

1-305-SK		55-59	\$4.95
----------	--	-------	--------

Bill's Truck Shop

Phone (905) 725-3460 / (905) 725-2022 /

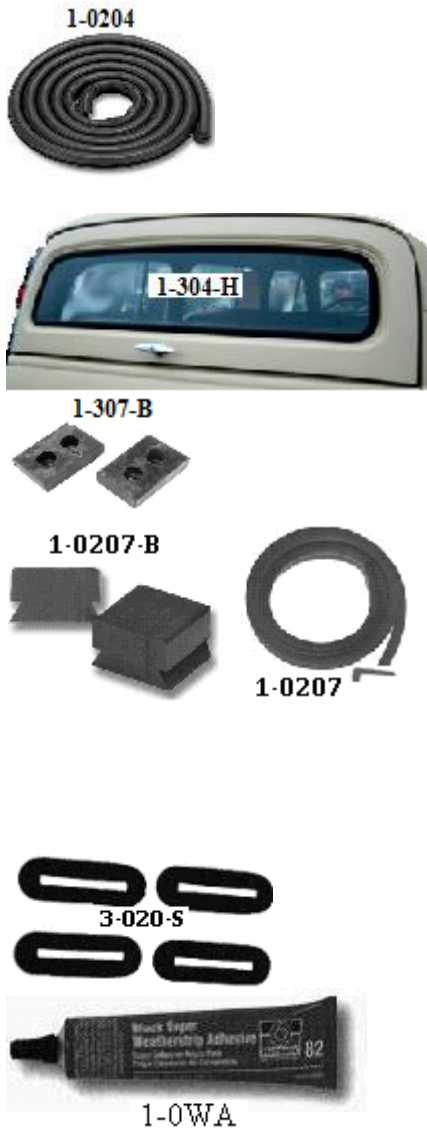

Panel & Suburban Rear Glass Weather-strip

1-0204 seal for rear glass in doors and upper hatch - universal type----- cut ½ for rear door glass 47-59 \$59.95

1-304-H in upper hatch w/ clam shell doors-correct OE 1 pc design w/o lock strip 55-59 \$99.00

Suburban Sliding Window Weatherstrip Kit

seals/channels & weather-stripping (per window)

11-0411-SL 55-66 \$159.95

Suburban Stationary Window Weatherstrip Kit

11-0411-ST per window 55-66 \$79.95

Rear Door Link Arm Bumper-Panel/Suburban

Rear Valance Seal-panel & suburban

1-0207 47-59 \$26.95

Door Hinge Seals

3-020-S panel/suburban w/ barn doors-set of 4 36-59 \$36.95

Weather strip Adhesive-black

1-0WA \$21.95

Bill's Truck Shop

Phone (905) 725-3460 / (905) 725-2022

Cab & Door Weatherstrip

Due to the fluctuation of the Canadian and American dollars call for current prices

Group 2

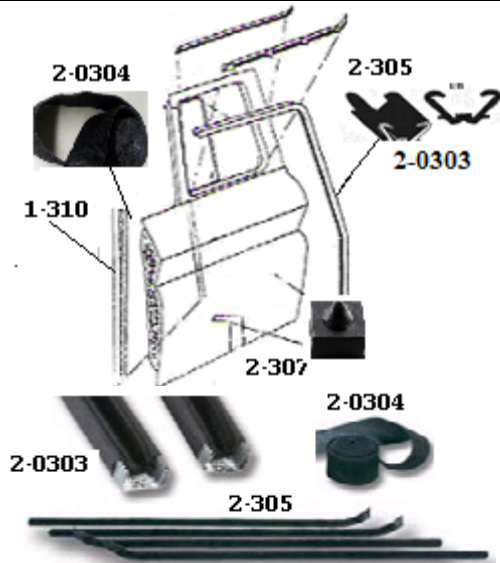

			<u>Year</u>	<u>New</u>
Division Bar Post - with liner /stainless beading				
12-0984	w/framed door glass	each	55-63	\$33.95
Door Glass Sash Seal				
13-312-S	& secures glass into sash	each	55-59	\$10.95
Door Glass Channel Runs				
2-0303	felt lined track for framed glass	pair	55-63	\$119.95
2-0303-1	single lined track		55-63	\$59.95
Installing one pc glass w/ metal frame				
11-405-1	60-63 Door Glass Channel Run	w/		
	out metal frame on glass	use 1 pr per door	60-63	\$129.95
Division Bar Relining Channels				
2-0304	felt liner w/glued back	pair	55-63	\$26.95
Door Window Seals/Scrapers With Clips				
2-305	w/ black beading	set of 4	55-59	\$129.95
2-305-S	w/ stainless beading	set of 4	55-59	\$129.95
2-306K-A	used when installing 1 pc glass-w/o			\$129.95
	vent windows & w/stainless beading	set of 4	55-59	
Door Felt Kit				
2-306K	includes 0303/0304/305	for 2 doors	55-59	\$269.95
Window Stop Bumper				
2-307		pair	55-59	\$3.95
Vent Window Rubber kit				
2-308	original design	pair	55-59	\$89.95
Vent Window rubber install kit-includes rivets//tool				
1-0VHK-55			55-63	\$14.95
2-010	a pair	of vent window pivot rivets		\$5.95
Glass Setting Tape –rubber- for door and vent glass				
1-0GST	0.062 thick	per foot		\$3.95
1-0GST-1	thinner 0.047 thick	per foot		\$2.95
Vent Window Ass install kit-2 doors				
13-313-SK	stainless steel		55-59	\$6.95
Door Bumper Set				
1-306	2 doors		55-59	\$7.95
Weather strip Adhesive-black				
1-0WA				\$21.95

Bill's Truck Shop

Phone (905) 725-3460 / (905) 725-2022

Hood – Fender

Due to the fluctuation of the Canadian and American dollars call for current prices

Group 3



		<u>Year</u>	<u>New</u>
Hood to Cowl Seal with retaining clips			
3-303		55-59	\$19.95
Hood Bumper Set			
3-303-55	10pcs	55-57	\$9.95
3-303-58	8 pcs	58-59	\$9.95
Hood Adjuster Bolt Chev-@rear of hood on cowl & GMC @ rear on cowl & front on hood latch support			
3-320-HA	original used each	55-59	
3-320-HS-S	stainless steel w/ washer ,set nut & bumpers pr	55-59	\$16.95
3-320-B	rubber cap for hood adjuster bolt pair	55-59	\$6.95
Inner Fender Mounting Grommets / inner fender @ cab & rad support			
3-304-G	4 pieces w/ steel sleeves	55-59	\$14.95
3-304-BK	correct recessed head bolts w/ locked on washers; sleeves & grommets set of 4	55-59	\$29.95
Inner Fender Support @ firewall			
34-355-S	left or right each	55-59	\$22.95
34-355-S-SS	stainless steel w/ hdw pr	55-59	\$29.95
Braces-Front Fender to Cab			
3-31F	steel/pair	55-59	\$39.95
3-31F-SS	stainless steel/pair	55-59	\$119.95
Inner Fender Seal Kit /U-shaped seal for rear of inner fender at firewall for both sides-included w/ 3-305			
3-304		55-59	\$13.95
Outer-Inner Fender Gasket set			
3-305	does both sides-includes 3-304 / 3-306	55-59	\$27.95
Outer Fender to Cab Seals included w/ #3-305			
3-306	glue to rear vertical of fender pair	55-59	\$8.95
Fender Align Grommets			
3-316	hole used to align inner to outer fender pair	55-59	\$3.95

Bill's Truck Shop

Phone (905) 725-3460 / (905) 725-2022

Hood – Fender

Due to the fluctuation of the Canadian and American dollars call for current prices

Group 3

55-57 hood hinge bolt spacing on firewall is 3 1/8 and 58-59 is 3 5/8 outside dia –top hole is in same location

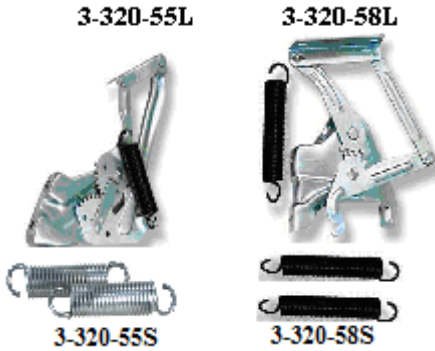

Hood Hinge

3-320-55L	w/ spring	left	55-57	\$129.95
3-320-55R	w/ spring	right	55-57	\$129.95
3-320-58L	w/ spring	left	58-59	\$144.95
3-320-58R	w/ spring	right	58-59	\$144.95

Hood Hinge bolt kit---note bolt size on cab-can be 5/16 or 3/8

3-320-55BK	3/8 on cab/5/16 on hood	8 bolts-both sides	55-57	\$24.95
3-320-58K	5/16	10 bolts-both sides	58-59	\$21.95

Hood Hinge Springs

3-320-55S	on hinge	pair	55-57	\$44.95
3-320-58S	hooks to fender	pair	58-59	\$44.95

Hood Latch Assembly

3-320-55C	Chev	55-57	\$129.95
3-320-58C	Chev	58-59	\$129.95

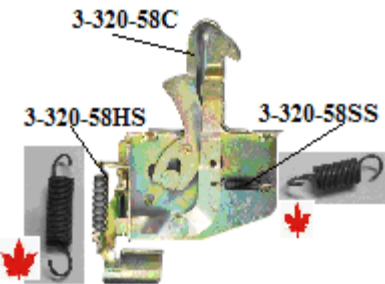

Hood Latch Handle Spring-

3-320-55HS	return spring	55-57	\$6.95
3-320-58HS	return spring	58-59	\$6.95

Hood Latch Clock Spring

3-320-55CS		55-57	\$19.95
------------	--	-------	---------

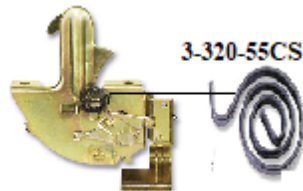

Hood Latch Safety Arm Spring

3-320-55SS		55-57	\$6.95
3-320-58SS	return spring	55-59	\$6.95

3-320-55C

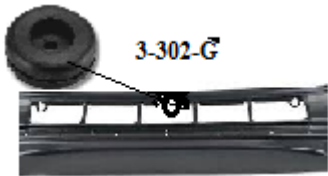

Cowl Screen Grommet

3-302-G	plug for cowl screen center	guide pin in firewall	55-59	\$2.95
---------	-----------------------------	-----------------------	-------	--------

Cowl Screen Screw set

3-302-S	stainless steel	5 pcs	55-59	\$2.95
---------	-----------------	-------	-------	--------

Bill's Truck Shop

Phone (905) 725-3460 / (905) 725-2022

Instruments

Due to the fluctuation of the Canadian and American dollars call for current prices

Group 4



4-300-C

4-306-C



4-305-CS



4-307-S

4-307-N



4-307-C



4-304-C



4-305-C



4-0SCS



8-306-5



4-311-C



4-310-C

4-0250-B



19-0469

Speedometer Assembly

4-300-C	Chev	55-59	\$299.95
---------	------	-------	----------

Gauge Decal Kit Die-cut nylar decals in correct size, shape and colour. Speedometer, odometer, and all gauges/GMC includes tach & clock

4-304-C	Chev	55-59	\$16.95
---------	------	-------	---------

Instrument Bezel w/ screws

4-305-C	Chev	55-59	\$89.95
---------	------	-------	---------

Instrument Bezels Screws set

4-305-CS	3 w/ j-nut	Chev	55-59	\$3.95
----------	------------	------	-------	--------

Instrument Bezel Gaskets Between bezel and glass

4-306-C	Chev	55-59	\$2.25
---------	------	-------	--------

Instrument Lens

4-307-C	Chev	55-59	\$79.95
---------	------	-------	---------

Turn Signal Indicator Housings in dash

4-307-S	cardboard housing w/ green lens	pair	55-59	\$9.95
---------	---------------------------------	------	-------	--------

Speedometer Needle

4-308-N	white	Chev	55-59	\$8.95
---------	-------	------	-------	--------

Speedometer Cable

4-0SCP	70 " w/ plastic housing	47-72	\$24.95
--------	-------------------------	-------	---------

4-0SCS	w/ steel casing 70 "	47-72	\$26.95
--------	----------------------	-------	---------

4-0SCP-0	w/ plastic casing 75"	47-72	\$39.95
----------	-----------------------	-------	---------

4-0SCP-1	w/ plastic casing 85"	47-72	\$59.95
----------	-----------------------	-------	---------

4-0SCP-2	w/ plastic casing 100"	47-72	\$59.95
----------	------------------------	-------	---------

Speedometer Cable Grommet

8-306-5	into 4-hole large grommet	55-59	\$3.95
---------	---------------------------	-------	--------

Fuel Gauge -battery "in" post on the "E" side of the gauge/ dash assembly must be grounded before testing

Fuel Gauge

4-310-C	Chev	55-59	\$149.95
---------	------	-------	----------

Temperature Gauge-please use insulator provided on external side mount plate

4-311-C	electric type /	Chev	56-59	\$139.95
---------	-----------------	------	-------	----------

4-311-CM	mechanical type/	Chev	55-55	\$129.95
----------	------------------	------	-------	----------

Temp Gauge Bushing

4-0250-B	reducer			\$12.95
----------	---------	--	--	---------

Temp Sender w/"T" connector

19-0469	6 or 8 Cyl—1/2 x 14 NPT w/ gauges	Late 55-72	\$45.95
---------	-----------------------------------	------------	---------

19-0469-A	6 or 8 cyl 1/2 x 14NPT w/ gauges- correct resistance for a more accurate OE gauge reading	57-78	\$39.95
-----------	---	-------	---------

Bill's Truck Shop

Phone (905) 725-3460 / (905) 725-2022



Oil Gauge				
4-312-C	Chev	55-59	\$124.95	
Oil Line kit				
5-0LK	5 ft copper tube w/ fittings	47-72	\$24.95	
68x2	brass block fitting		\$2.95	
5-0682	V8 block fitting w/ comp fitting		\$4.45	
Amp Gauge				
4-313-C	Chev	55-59	\$139.00	
Dash Gauge Insulator/warning Label kit				
4-0200-K		47-59	\$7.95	
Gauge Cluster Assembly w/ 58-59 electric temp gauge				
4-315-A	complete w/gauges & speedo Chev only	55-59	\$899.95	
Fuel Gauge Volt Reducer				
4-210-VR	electronic reducer for gauges from 12 to 6 volts	47-55	\$28.95	
Voltage Reducer when changing to 12 volts				
4-210-VRA	for heater motor , radio & accessory	47-55	\$6.95	
Dome Lamp Assembly complete-w/12 V bulb				
4-316-C	chrome housing	55-59	\$47.95	
Dome Lamp Lens				
4-316-L		55-59	\$8.95	
Dome Lamp Bulb				
4-0316-B	12 volt-double contact	55-59	\$3.95	
Cigarette Lighter Assembly				
18-310	w/chrome knob w/o harness	55-59	\$37.95	

NO WARRANTY ON GAUGES IF INSTALLED INCORRECTLY

Bill's Truck Shop
 Phone (905) 725-3460 / (905) 725-2022



4-358-C



4-356-C

4-ORIV



ID Plates-etched silver tags shows vehicle manufacture, gross weight, horsepower-provision for stamping neck info 1/2 ton

For- AMERICAN BUILT TRUCKS

4-355-C	Chev 5000 LBS	55-55	\$32.95
4-356-C	Chev 5000 LBS	56-57	\$32.95
4-358-C	235- 6 cyl & 283 -8 cyl Chev 5000 LBS	58-59	\$37.95

Rivets-I.D. Plates- original plug style

4-ORIV	pair	47-59	\$7.95
--------	------	-------	--------

Bill's Truck Shop

Phone (905) 725-3460 / (905) 725-2022



For these rebuilt assemblies contact-Rick
940-300-5235



Oil Line kit

5-0LK	5 ft copper tube w/ fittings	47-72	\$34.95
68x2	brass block fitting		\$2.95

Gauge Decal Kit

Die-cut nylar decals in correct size, shape and colour. Speedometer, odometer, and all gauges/GMC includes tach & clock

4-0304-G	GMC	55-59	\$23.95
----------	-----	-------	---------

Instrument Bezels Screws set

4-305-GS	GMC	12 pcs	55-59	\$4.95
----------	-----	--------	-------	--------

Instrument Bezel Gaskets

4-306-G	housing to dash	GMC	pr	55-59	\$24.95
---------	-----------------	-----	----	-------	---------

940-300-5235

'Rick Hendrickson' capt_rick1912@yahoo.com

INQUIRE ABOUT ANY GMC GAUGE ITEMS

Bill's Truck Shop

Phone (905) 725-3460 / (905) 725-2022

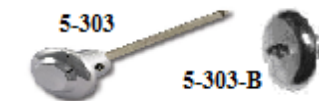
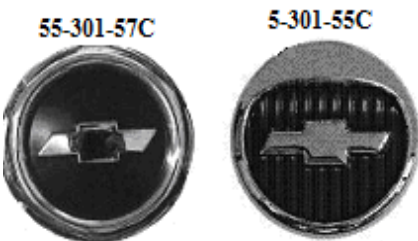

		<u>Year</u>	<u>New</u>
Steering Wheel			
5-0200-54	black	54-56	\$449.95
5-0300-57	black	57-60	\$459.95
Horn Cap – Chevrolet			
5-301-55C	stands 1 ¼ “ tall	55-56	\$79.95
5-301-57C	stands 2 “ tall	57-59	\$79.95
5-301-57G	GMC stands 2” tall	57-59	\$100.00
Horn Contact & Cap Retainer			
5-0301-3		54-59	\$41.95
Horn Contact Pin Spring & Bushing			
5-0201-4		47-66	\$12.95
Steering Wheel Retaining Nut w/ washer			
5-0230-N		47-72	\$1.95
Spring-Upper Column Bearing			
5-0201-S		47-59	\$8.95
Light Knob and Rod			
5-303	Chev w/ chrome knob	55-59	\$22.95
Light Switch Retainer- Bezel			
5-303-B		55-59	\$16.95
Wiper Knob			
5-304	chrome w/ 9/32 w/ pentagon hole & set screw	55-59	\$24.95
5-304-A	black w/pentagon hole w/ set screw /paint white for GMC w/ manual cable control	55-59	\$13.95
5-304-CW	chrome w/pentagon-hole & original washer button hole w/ set screw	55-59	\$23.95
Wiper Switch Nut /Bezel			
5-0304-B	fits OE & replacement switches	55-59	\$14.95
Radio Knob & replacement electric wiper switch			
36-309	chrome w/ 3/16 hole & set screw	55-59	\$21.95
Turnsignal Lever With Knob approx 46 “ long			
5-305-1	chrome w/ black knob	55-59	\$21.95

Bill's Truck Shop

Phone (905) 725-3460 / (905) 725-2022



5-0209

5-0209-S



5-307-C



5-308-C

Dash Plug

5-306-C stainless steel-Chev-GMC 55-59 \$13.95

Throttle Cable Grommet

5-308-G 1/2 hole in trans tunnel above accel pivot 55-59 \$2.45

Cable Lock Stop

5-0209 \$3.45

Choke Knob With Cable approx. 46" long

5-307-B w/ black knob 55-59 \$29.95

5-307-C w/ chrome knob 55-59 \$29.95

Throttle Knob With Cable

5-308-B w/ black knob 55-59 \$29.95

5-308-C w/ chrome knob 55-59 \$29.95

Bill's Truck Shop

Phone (905) 725-3460 / (905) 725-2022

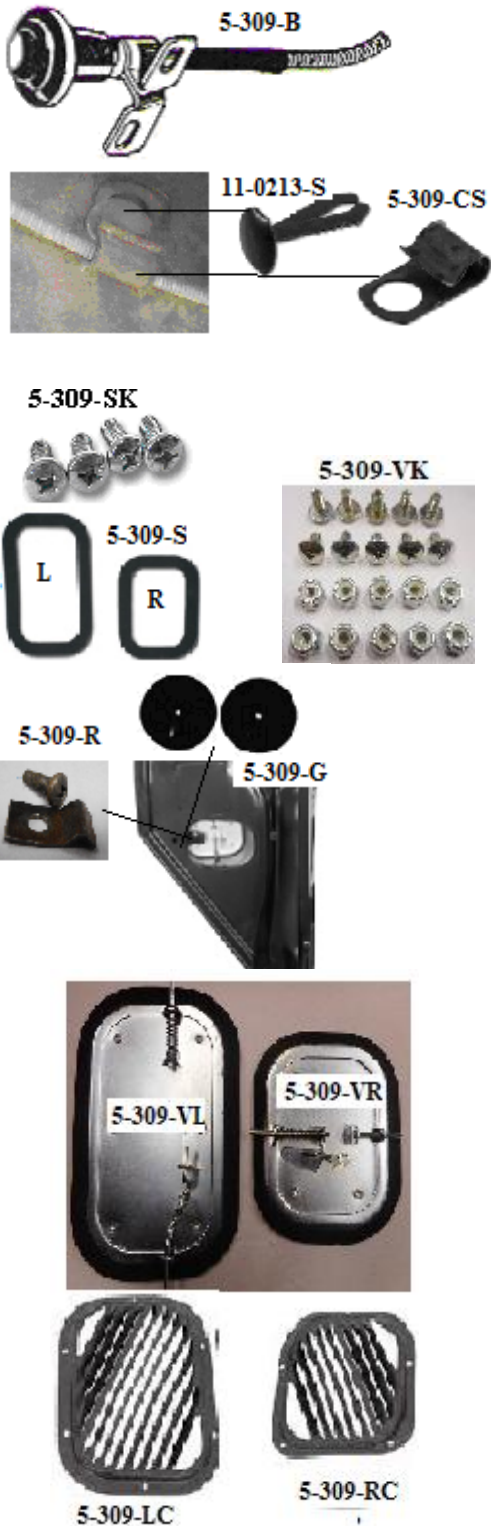

		<u>Year</u>	<u>New</u>
Cowl Vent Knob w/ Cable-fits L or R- approx. 63 " does not have OE type support			
5-309-B	w/ black knob	55-59	\$38.95
5-309-C	w/ chrome knob	55-59	\$39.95
Cowl Vent Cable Support Screw kit			
5-309-SK	4 screws w/ washers	55-59	\$2.95
Cowl Vent Cable Support –L & R cable on firewall			
5-309-CS	each	55-59	\$9.95
Cowl Vent Cable Grommet @ vent			
5-309-G	pair	55-59	\$4.95
Cowl Vent Valve Seal Set			
5-309-S	replaces flapper seal L & R	pair 55-59	\$6.95
Cowl Vent Valve HDW kit			
5-309-VK	screws w/ nylon lock nut to assemble 2 halves when installing new seals	20 pcs 55-59	\$2.95
Cowl Vent Cable Retainer @ valve			
5-309-R	2 retainers w/screws	55-59	\$14.95
Cowl Vent Cover Seal			
5-309-VS	black sealer/caulking strips	set 55-59	\$9.95
Cowl Vent Cover screw set-both side			
5-309-CK	7 stainless screws	55-59	\$2.95
Cowl Vent Valve			
5-309-VL	left	55-59	\$49.95
5-309-VR	right	55-59	\$49.95

Bill's Truck Shop

Phone (905) 725-3460 / (905) 725-2022

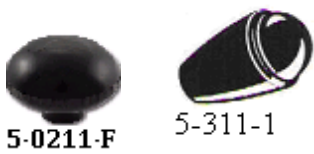

5-313-G



5-313-GH

5-0215-S



5-315



5-0216-K



5-019

5-0220-P

5-0230-N

5-317-G



3-0440-G



Year New

Gearshift Knob

5-311-1	3 speed & aut black	55-59	\$12.95
5-0211-F	floor shift-black-can also be used on NAPCO shifter---no markings	40-59	\$16.95

Shift Bracket

5-315		55-59	\$44.95
-------	--	-------	---------

Column Shift Bracket Screws

5-0215-S	¼ x 28- 3/8 fine thread-stainless steel –we now include external countersunk washer to help prevent screw from coming loose	pair	47-59	\$7.95
----------	---	------	-------	--------

Column Shift Lever Kit includes pins/springs & bushings

5-0216-K			47-59	\$36.95
----------	--	--	-------	---------

Shift Rod Grommet

3-0440-G	with metal lining	each	47-66	\$6.95
5-317-G	set of 4-rubber		55-59	\$6.95

Shifter Boot at shift box

5-019			47-59	\$4.95
-------	--	--	-------	--------

Shifter Box Plug

5-0220-P	stainless cap on 3 speed shift box		47-55	\$1.95
----------	------------------------------------	--	-------	--------

Steering Wheel Retaining Nut w/ washer

5-0230-N			47-72	\$1.95
----------	--	--	-------	--------

Bill's Truck Shop

Phone (905) 725-3460 / (905) 725-2022

Year New



Steering Column mount hdw kit

5-316-HK washers, spacers, bolts 55-50 \$19.95



Steering Column Clamp Bushing

5-0316 55-59 \$4.95

Steering Column Support Pads-

5-0216-P between column support & dash pair 54-59 \$3.95

Bill's Truck Shop

Phone (905) 725-3460 / (905) 725-2022

		<u>Year</u>	<u>New</u>
		Accelerator Pedal	
7-0301-55		53-57	\$26.95
7-301-58		58-59	\$26.95
		Accelerator Pedal Pivot Pin and Clip	
7-0201-2		47-57	\$6.95
		Accelerator Pedal Shaft Floor Seal	
7-0201-4		47-59	\$6.95
		Accelerator Rod	
7-0517	Accelerator Rod - pedal to cab- 6 or 8 cyl 15" long w/ sivel & cotter pins	55-70	\$34.95
7-0517-S	swivel w/ hdw	55-70	\$5.95
		Brake & Clutch Pedal Pad	
7-303-1	each	55-59	\$5.95
		Brake & Clutch Floor Shaft Seals	
7-303		55-59	\$5.95
		Clutch-Brake Arm Stop Bumper	
7-003-S	55-59 clutch only	each	47-59 \$2.95
		Brake & Clutch Pedal Bushings (pair)	
7-303-B	brass oversize to repair worn shaft-machine as nec	55-59	\$24.95
		Parking Brake Rod Seal -	
7-304-1	at firewall	55-59	\$2.95
		Park Brake Return Spring	
37-0310-R	spring w/ rod-locates @ center frame support- and 66 early production 9" long	55-65	\$11.95
37-310-E1	6 ft short bed extension	55-59	\$5.25
		Park Brake Handle Spring w/hand brake	
38-0219-HS	with brake @ trans	29-59	\$13.95

Bill's Truck Shop

Phone (905) 725-3460 / (905) 725-2022

		<u>Year</u>	<u>New</u>
Requires closing shift tube hole w/floor shift			
Steering Column Floor Retainer& Seal			
7-308-4	column shift includes screws	55-59	\$31.95
Steering Column Floor Seal only			
7-308-S		55-59	\$5.95
Starter Pedal Pad			
7-0315-P	w /foot pedal start-rubber	47-59	\$7.95
Starter Bellows			
7-0315		47-59	\$11.95
Clutch Head Driver Set			
5-0CHSD-4	4 x screw drivers	47-61	\$34.95
5-0CHS-4	4 x 3/8 drive sockets	47-61	\$34.95

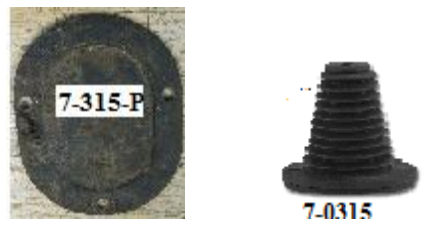

Bill's Truck Shop
 Phone (905) 725-3460 / (905) 725-2022



	<u>Year</u>	<u>New</u>
Floor Shift Sponge Seal 4 speed		
6-0FSS	47-66	\$9.95
Floor Shift Boot		
8-0SB-C w/ Chev emblem	47-66	\$22.95
8-0SB-B blank	47-66	\$13.95
Floor Shift Boot Retainer		
6-0BR 14G brushed stainless steel w/screws	47-66	\$29.95
Hand Brake Sponge Seal		
8-0204-S floor mounted	37-59	\$5.95
Hand Brake Boot		
8-0204-B	47-59	\$18.95
Hand Brake Boot Retainer		
8-0204-R 14G brushed stainless steel w/screws	47-59	\$19.95
Master Cylinder Access Plug		
8-0325	47-59	\$11.95
Main Wire Harness Firewall Grommet		
8-0105 on right firewall @ battery tray-55-59	47-59	\$3.95
Starter Wire Firewall Grommet		
8-306-2 upper firewall on pass side w/ 7/8 hole	55-59	\$3.25
Four Hole Firewall Grommet-check hole size		
8-0206-4 choke/ speedo 1 1/8 " hole at upper left firewall usually 2 required	50-59	\$4.95
8-306-5 vac/speedo/oil 1 1/4 hole check hole size for correct application-also GMC hole size	55-59	\$3.95
Firewall Grommet kit		
8-306-K 1 x 8-0105/8-0206-4/8-306-5/8-306-2	55-59	\$13.95
Transmission Floor Cover		
8-308 3 speed column Shift	55-59	\$129.95
8-308-1 4 speed floor shift	55-59	\$99.95
Transmission Floor Cover Gasket		
8-308-2	55-59	\$14.95
Transmission Floor Cover Screw Set		
8-308-3 9pc	55-59	\$4.95
Battery Hold Down Hardware		
8-309-4 2 bolts and wing nuts and washer	55-59	\$10.95
Battery Box		
8-309-55	55-57	\$84.95
8-309-58	58-59	\$79.95

Bill's Truck Shop

Phone (905) 725-3460 / (905) 725-2022



		<u>Year</u>	<u>New</u>
Battery Retainer			
8-309-55R	10.5" long x 7" wide	55-57	\$26.95
20-0425-R		58-66	\$19.95
Battery Tray Bolt Kit			
8-309-K	OE style washer head bolts/ cadmium plated	55-59	\$6.25
Ground Strap -braided as original			
8-0462	battery to body 11 "	47-59	\$59.95
8-0463	engine to body 12"	47-59	\$39.95
Battery to Starter # 4 gauge w/12 volt system w/ top post			
8-3464-C	6 cyl 30 " long cloth covered	55-59	\$39.95
8-3464-B	6 cyl 30 " long vinyl covered	55-59	\$39.95
8-3465-C	8 cyl 52 " long cloth covered	55-59	\$49.95
8-3465-B	8 cyl 52 " long red vinyl covered	55-59	\$32.95
Battery Cable End-replacement clamp style			
8-0880	battery cable end		\$3.95
Battery Adaptors-side post cable to top post battery			
8-0878	pair		\$9.95
Battery Cable Cover-top post/slip on			
8-0760-R	red/positive		\$3.25
8-0760-B	black/neg		\$3.25
19-0655-K-C	4 pc body ground kit-copper		\$17.95

Bill's Truck Shop
 Phone (905) 725-3460 / (905) 725-2022

Glove Box Door/Dash

Due to the fluctuation of the Canadian and American dollars call for current prices

Group 9

			<u>Year</u>	<u>New</u>
	9-301-C			
Glove Box Door w/hinge				
	9-301-HC			
	9-301-A			
	9-301-SK	10 screws w/ washers	55-59	\$4.95
	9-302-C		Chev	55-59 \$34.95
	9-301-5	set of 7	55-59	\$5.95
	5-0GBB	pair	47-72	\$2.50
	5-0221	w/o key	54-72	\$35.95
	5-0222	Original Style w 2 keys	54-72	\$45.95
	5-0223		54-72	\$1.50
	5-0224		54-72	\$4.50
	9-0201-13		54-59	\$9.95
	5-0GBL		54-72	\$23.95

Bill's Truck Shop

Phone (905) 725-3460 / (905) 725-2022

Interior Parts

Due to the fluctuation of the Canadian and American dollars call for current prices

Group 10

		<u>Year</u>	<u>New</u>	
	Headliner w/ original style pattern			
	10-305-B	black -plastic	55-59	\$79.95
	10-305-W	white	55-59	\$79.95
	Headliner Retainer Seal			
	10-306-B	black rubber seal	55-59	\$45.95
	Headliner Insulation			
	10-305-I		55-59	\$32.95
	This original replacement water resistant pressboard headliner is covered with Madrid Grain Vinyl with dielectric heated sealed seams installed w/ Velcro (provided) and original rubber seal (add to order)			
	10-305-2295	black	55-59	\$269.95
	10-305-4545	maroon	55-59	\$269.95
	10-305-0511	red	55-59	\$269.95
	10-305-4489	navy blue	55-59	\$269.95
	10-305-2309	medium blue	55-59	\$269.95
	10-305-3608	light blue	55-59	\$269.95
	10-305-90022	palomino	55-59	\$269.95
	10-305-4533	dark saddle—special order	55-59	
	10-305-6758	medium grey	55-59	\$269.95
	10-305-0702	charcoal	55-59	\$269.95
	10-305-4544	saddle	55-59	\$269.95
		Armrest w-hardware		
		10-0204-BK	black	55-66
10-0204-BR		brown	55-66	\$79.95
10-0204-G		grey	55-66	\$79.95
10-0204-R		red w/ beige base	55-66	\$79.95
	Armrest Screw			
	9-0773-AS	¼ x 20 x 1 1/4 philips screw	pair	47-72
	Armrest Nut			
	9-0773-AN	cage nut	pair	47-72

Bill's Truck Shop

Phone (905) 725-3460 / (905) 725-2022



When ordering seat belts there are many issues that will have to be addressed –eg-buckets-bench-height of seat-mount location etc / note- 3 point system lock buckle must be on side of person
Some applications may require an extender-see below for 6” metal ext or 12” belt extension

New

Seat Belts /lap style-w/ hdw.-per person

Push button STD (coloured) 22”long w/female end & 38” long w/ male end // or lift lever (chrome) type DLX 22” long male end & 38” long female end- 60 “ DLX 42” long male end & 30” long female end-72”

SB-N2PB	black w/ std buckle	\$79.95
SB-N2PR	red w/ std buckle	\$79.95
SB-N2PG	grey w/ std buckle	\$79.95
SB-N2PT	tan w/ std buckle	\$79.95
SB-N2PN	navy blue w std buckle	\$79.95
SB-N2PM	maroon w/ std buckle	\$79.95
SB-N2LB	black w/chrome buckle	\$89.95
SB-N2LB-72	black w/chrome buckle 72” long	\$69.95
SB-N2LG	grey w/ chrome buckle	\$89.95
SB-N2LN	navy blue w/chrome buckle	\$89.95
SB-N2LN-72	blue w/chrome buckle 72” long	\$89.95
SB-N2LR	red w/ chrome buckle	\$89.95
SB-N2LTAN	tan w/ chrome buckle	\$89.95

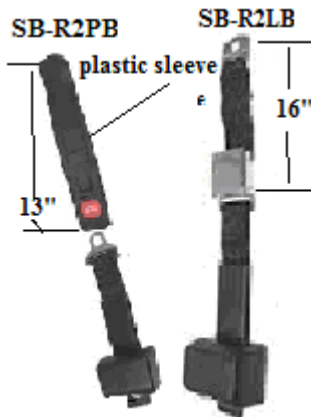

2-point retractable w/ hdw-- 13 “ female w/ plastic sleeve/16” w/ loose end

Push button STD or lift lever (chrome) type DLX

SB-R2PB	black w/ std buckle	each	\$149.95
SB-R2PR	red w/ std buckle	each	\$149.95
SB-R2PG	grey w/ std buckle	each	\$149.95
SB-R2PT	tan w/ std buckle	each	\$149.95
SB-R2PM	maroon w/ std buckle	each	\$149.95
SB-R2PN	blue w/ std buckle	each	\$149.95
SB-R2LB	black w/ dlx	each	\$159.95
SB-R2LR	red w/ dlx	each	\$144.95
SB-R2LT	tan w/ dlx	each	\$144.95
SB-R2LG	gray w/ dlx	each	\$144.95

Bill's Truck Shop

Phone (905) 725-3460 / (905) 725-2022

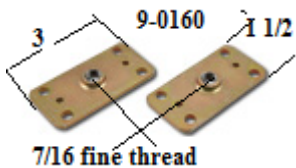

When ordering seat belts there are many issues that will have to be addressed -eg-buckets-bench-height of seat-mount location etc / note- 3 point system lock buckle must be on side of person

Some applications may require an extender-see below for 6" metal ext or 12" belt extension

3-point retractable w /hdw and chrome lift latch (air plane style) approx 24" inner female

SB-R3LB black w/ chrome buckle each \$249.95

SB-R3LDB dark blue w/chrome buckle each \$186.95

3-point retractable w /hdw

Push button STD (coloured) or lift lever (chrome) type DLX

SB-R3PB black w/ std buckle each \$214.95

SB-R3PG gray w/ std buckle each \$214.95

SB-R3PM maroon w/ std buckle each \$214.95

SB-R3PT tan w/ standard buckle each \$214.95

SB-R3PN navy blue w/ std buckle each \$214.95

Anchor Plates

9-0160 w/ shoulder belt -7/16 fine thread / pr 47-66 \$34.95

Belt Extension w/ hdw

SB-12XBK black \$24.95

SB-12XBL navy blue \$24.95

SB-12XR red \$24.95

SB-12XT tan Inquire

SB-12XG gray \$24.95

Metal Extension

FAB-1008-1 1 " 90 deg " ext \$11.95

FAB-1001-3 8 " ext w/3 holes @ 2 1/2 apart- cut to desired length as required \$11.95

Seat Belt Retractors-pr a reproduction of an OE option- for non retractable seat belts-prevents belt from falling out vehicle doors

9-0SBR pair \$34.95

Bill's Truck Shop

Phone (905) 725-3460 / (905) 725-2022

Interior Parts

Due to the fluctuation of the Canadian and American dollars call for current prices

Group 11

11-0205-BK



11-0205-C



include w/ new visors

11-3275-90022



includes screws w/ new

11-205-R



11-0205-2

Sun Visors includes end clips each

11-0205-BK	black	47-59	\$54.95
11-0205-BR	brown	47-59	\$49.95
11-0205-G	grey	47-59	\$49.95
11-0205-M	maroon	47-59	\$49.95
11-0205-R	red	47-59	\$49.95

Special order -madrid grain vinal-sold as a pr

11-3275-2295	black	55-59	\$194.95
11-3275-4545	maroon	55-59	\$179.95
11-3275-0511	red	55-59	\$179.95
11-3275-4489	navy blue	55-59	\$179.95
11-3275-3608	light blue	55-59	\$179.95
11-3275-2309	medium blue	55-59	\$179.95
11-3275-90022	palomino	55-59	\$179.95
11-3275-4533	dark saddle	55-59	\$179.95
11-3275-6758	medium grey	55-59	\$179.95
11-3275-0702	charcoal	55-59	\$179.95

Sun Visor Bracket - chrome with screws

11-305-L		55-59	\$36.95
11-305-R		55-59	\$36.95

Sun Visor Bracket Screw kit

11-0205-2	3 pcs	47-59	\$1.25
-----------	-------	-------	--------

Sun Visor End Clips

Stainless-steel clips for uncovered visor.

11-0205-C	pair	47-66	\$3.50
-----------	------	-------	--------

Bill's Truck Shop

Phone (905) 725-3460 / (905) 725-2022

inquire about other colour combinations & vinyl-cloth

SEAT COVERS

Cover *Heavy Duty vinyl similar to original colour and grain w/stitched foam backing –madrid vinyl inquire about other colour combinations*



11-207



11-306-BKV-P	black pleated vinyl	55-59	\$544.95
11-306-BKV	black non pleated vinyl	55-59	\$469.95
11-306-DSV	dark saddle non pleated vinal	55-59	\$469.95
11-306-LBV-P	light blue w/ pleats	55-59	\$544.95
11-306-BK2	black scottsdale velour inserts w/o pleats w/ black vinyl trim	55.59	\$544.95

Piping can be added to edge in all colours- inquire-there is \$125.00 extra charge

11-OPIP \$125.00

ECONOMY SEAT COVER

Seat Cover	replacement- vinyl cover only		
11-307-BV	black vinyl	55-59	\$269.95
11-307-BNV	brown vinyl	55-59	\$269.95
11-307-GRV	gray vinyl	55-59	\$269.95

Seat Upholstery Installation Kit

11-307-K	includes burlap and cotton padding-used when installing all vinal seat cover	55-59	\$29.95
----------	--	-------	---------

Seat Cover-CAMEO style 2 tone velour/cloth/vinyl









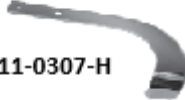

11-306-BK2	black Scottsdale cloth w/ black madrid vinyl subs w/ out pleats	55-59	\$544.95
11-306-BK2-P	black Scottsdale (encore) velour w/ black madrid vinyl subs w/ pleats	55-59	\$544.95
11-306-RB2	royal blue velour w/ white madrid vinal subs w/o pleats	55-59	\$544.95

*Many other colour combinations available
Call for sample pictures of material and seats*

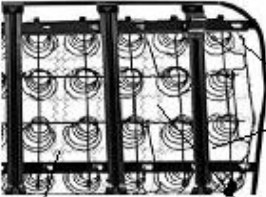

Seat to Frame Clip kit

11-0SC	70 pieces	39-59	\$18.50
--------	-----------	-------	---------

			<u>Year</u>	<u>New</u>
	11-0307-H			
	11-308-PB			
	11-0209			
	11-308			
	11-0307-S			
	8-0070			
	11-0207-S			
	11-308-CS			
	11-0207-S			
	11-308-SB			
Seat Spring Tie Clip		11-0209 secures spring together set of 3	47-72	\$2.95
Seat Frame Filler Plug		11-308 rubber seat frame end caps -pr	55-59	\$25.95
Seat Adjuster cable kit		8-0070 Cable-seat adjust kit w/ adjustable turnbuckle	50-87	\$12.95
Seat Adjust Handle		11-0307-H stainless steel w/ hdw	55-66	\$39.95
Seat Return Spring		11-0307-S	55-80	\$11.95
Seat Arm Pivot Bolt		11-308-PB w/ shim and spacer each	55-59	\$3.00
Seat Cushion Spring-fits bottom & back (replace you broken and sagged springs) see 11-0207-S to connect together		11-308-CS vertical coil spring each	55-59	\$17.95
Springs NEW		11-0207-S seat coil tension spring-set of 4 Secures the standing springs	47-59	\$14.95
Seat Base (special order)		11-308-SB		\$395.00

Bill's Truck Shop

Phone (905) 725-3460 / (905) 725-2022



Carpet with Underlay

Cut to fit with edges sewn & underlay- inquire about many other colours-**LOOP PILE**- also available in **NYLON CUP PILE**
 Also note w/ high hump floor-add HH (4 speed)
 All carpet are extra long for no gas tank
Can also be ordered w/o holes for pedals -- NH

		Year	New
11-310-B	black	55-59	\$319.95
11-310-G	gun metal grey	55-59	\$319.95
11-310-R	red	55-59	\$319.95
11-310-B-NH	w/out pedal holes black	55-59	\$319.95

CARPET- 2 yards – call for other colours

8-000Y-01	black-loop pile approx 80 “ x 72”		\$144.95
10782	Dimmer switch grommet-(included w/ new carpet)		\$8.95

Sill Plates aluminum-bright polished machined w/ screws-secures carpet/rubber mat to rocker step edge---see picture on bottom of page

11-3076	front left and right	pair	55-59	\$278.95
11-3077	rear	each	55-59	\$64.95

Rubber Floor mat

11-311-3	automatic or 3 speed std	black	55-59	\$299.95
11-311-4	4 speed w/ HH	NEW VINAL includes felt backing-w/o holes-may require some edge trimming	55-59	\$319.95

Felt Mat

11-312-FM	helps reduce noise & heat		55-59	\$44.95
-----------	---------------------------	--	-------	---------

Sound Deadener

11-312-SD	Floor Deadener kit-Die-cut asphalt based material w/ foam liner		55-59	\$109.95
-----------	---	--	-------	----------

11-0HSD	Universal heat & sound insulation – 3/8 single sided foil backed w/ jute liner 4 x 6			\$52.95
---------	--	--	--	---------

Inner Firewall Cover

Pre-cut rubber and felt laminated on one sheet.

11-313			55-59	\$89.95
--------	--	--	-------	---------

Inner Firewall Cover Retainers

11-313-R	may require hole enlargement-- plastic (9)		55-59	\$12.95
11-0213-S	OE metal type-each		47-59	\$6.50

Bill's Truck Shop

Phone (905) 725-3460 / (905) 725-2022



Door Parts

Due to the fluctuation of the Canadian and American dollars call for current prices

Group 12



			<u>Year</u>	<u>New</u>
Inside Door Handle (each) with a set screw				
12-01DH	chrome		47-66	\$29.95
Inside Window Handle with set screw				
12-01WH	chrome black knob		47-66	\$29.95
Inside Handle Gasket Set				
12-01HG	sponge seals & fibre washers		47-66	\$10.95
Interior Handle Escutcheon				
12-01HE	grey	each	47-87	\$2.95
Inside Handle Set Screw for OE handles only- some applications used a 2nd lock set screw above				
12-0204	¼ x 20 hex head	each	47-66	\$0.60
12-0204-S	set screw 1/4-20x3/8		47-66	\$1.00
Outside Door Handles (with gaskets & screws)				
12-0107	w/out right side button / lock	pair	52-59	\$99.95
12-0107-1	for rear on panel/suburban door w/o button or lock		52-59	\$49.95
Door Handle (outer)screw kit- 8 pcs				
12-0025-HK			52-72	\$3.50
Outside Door Lock With Key (2 keys)				
12-305-1	front doors and rear door on panel /suburban single door lock w/ 1 7/8 shaft length		55-59	\$72.95
12-305-2	2 door locks- can be used on ft & rear door		55-59	\$144.95
12-305-3	ignition cylinder/glove box & 2 door locks		55-59	\$169.95
Outside Handle Gasket Set				
12-0205			52-66	\$5.95
Outside Handle Scratch Shields Chrome Plated				
12-0185		pair	52-59	\$46.95
Vent Handle Kit Chrome plated with pin and washer				
12-306-L		left	55-59	\$22.95
12-306-R		right	55-59	\$22.95
Vent Handle Roll Pin				
12-0996		each	51-72	\$0.30

Bill's Truck Shop

Phone (905) 725-3460 / (905) 725-2022



			Year	New
Door Hinges				
12-307-L	fits L or R Lower	each	55-59	\$109.95
12-307-U	fits L or R upper (w/ door check)	each	55-59	\$109.95
Door Hinge Rebuilt Kit				
12-0HPK	2 (11/32) pins / 4 (13/32) OS brass bushing		47-87	\$14.95
Door Hinge Check Spring				
12-307-2	on upper door hinge	each	55-59	\$3.25
Door Hinge Cage Nut new item				
12-0307-CN	3/8 fine thread rectangular nut	each	55-59	\$17.95
Door Hinge Bolts OE is all fine thread-thicker part of hinge requires the longer bolt				
12-0422-OE	OE style w/ floating washer head	3/8 fine-1" long each	55-59	\$2.25
12-0207-B	replacement style	3/8 x 1 fine thread w/ washer each	55-59	\$1.15
Lower Door Drain Plug				
12-310	set of 4		55-59	\$14.95
Lower Hinge Access Panels --single available ONLY while supplies last 12-307-LP & RP				
12-307-PR	L m& R pair		55-59	\$36.95
12-307-S	panel screws stainless steel	8pcs	55-59	\$2.95

Bill's Truck Shop

Phone (905) 725-3460 / (905) 725-2022

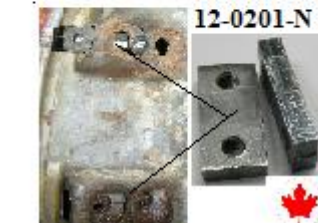
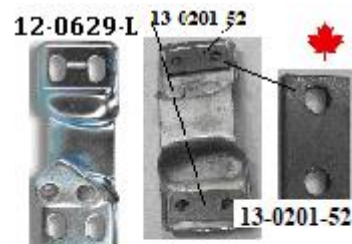
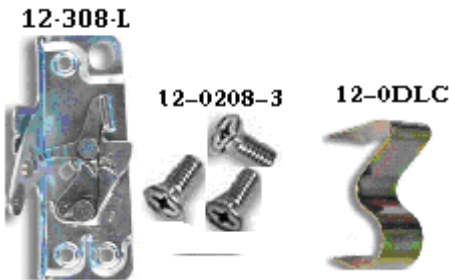

Door Latch-----door latch & strikers CANNOT be used to adjust door fitment

		Year	New
12-308-L	Left	55-59	\$89.95
12-308-R	Right	55-59	\$89.95
12-308-1R	panel / suburban rear door	55-59	\$69.95

Door Latch Screw Kit

12-0208-3	3 pcs per side	52-59	\$3.45
-----------	----------------	-------	--------

Door Latch Repair Clip -

12-0DLC	corrects a lot of door closing issues	each	47-63	\$12.95
---------	---------------------------------------	------	-------	---------

Door Striker- mounts on door jamb (each)

12-0629-PR	sold as pair only	52-63	\$36.95
12-0629-R	fits panel / suburban with rear barn doors	52-63	\$14.95

5/16-18 coarse thread ---- 5/16-24 fine thread

1/4-20 coarse thread-----1/4-28 fine thread

PLEASE CHECK BEFORE ORDERING -type of hdw -OE info 1/4 -20 NC SCREWS OR 5/16-24 NF SCREWS @ STRIKER

Door Striker Screw Kit -late 57 up did not use 1/4-20 clutch driver screws-used 5/16 -24 UNF hex low washer head bolts

12-0630	4 screws w/ washers 1/4 -20 NC per side	52-early 57	\$2.95
---------	---	-------------	--------

Door Striker Hdw kit

12-0630-K	4 x 1/4-20 NC Philips drive screws w/ washer,shims & nut plates	1 side	52-early 57	\$19.95
-----------	---	--------	-------------	---------

Door Striker Nut Plate

12-0201-N	threaded (1/4 -20) plate in backside of "B" pillar for striker screws	pair	47-early 57	\$12.95
-----------	---	------	-------------	---------

Door Striker hdw kit

12-0631-K	4x 5/16-18 NC-clutch head stainless screws-4 washers,2 shims & 2 nut plates	per side	Late 57-59	\$24.95
-----------	---	----------	------------	---------

Door Striker Shims

13-0201-52	1/8 x 1 7/16 long x 3/4 wide	behind both ends of the striker for correct latch contact	pair	52-63	\$12.95
------------	------------------------------	---	------	-------	---------

Bill's Truck Shop

Phone (905) 725-3460 / (905) 725-2022

Door Parts

Due to the fluctuation of the Canadian and American dollars call for current prices

Group 12

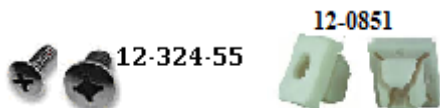
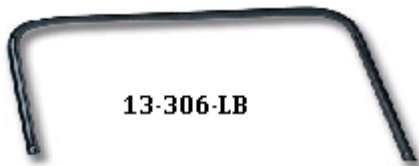
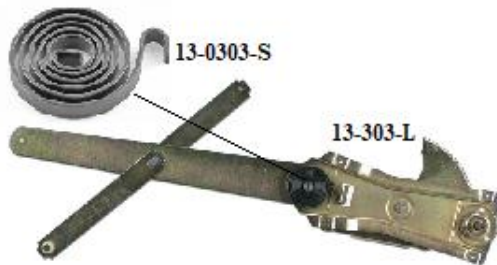

Door Control

12-305-L	left	55-59	\$44.95
12-305-R	right	55-59	\$44.95

Door Control Hdw kit -both sides

12-0205-K	6(zinc) screws w/ tooth washer-Philips drive	47-72	\$2.95
-----------	--	-------	--------

13-0302-R	roller & pin	55-63	\$6.25
-----------	--------------	-------	--------

Window Regulator

13-303-L	left	55-59	\$99.95
13-303-R	right	55-59	\$99.95

Window Regulator Hdw Install kit

13-0203-SK	per side	51-72	\$3.45
------------	----------	-------	--------

Window Regulator Gear Assembly w/ rivets

13-0303-G		55-63	\$58.95
-----------	--	-------	---------

Door Window Moulding -Inner

13-306-LB	black	55-59	\$86.95
13-306-RB	black	55-59	\$86.95
13-306-LC	chrome	55-59	\$114.95
13-306-RC	chrome	55-59	\$114.95

Door Moulding Fastener Set-clips/screws/j-nuts

13-307	both doors	55-59	\$18.95
--------	------------	-------	---------

Door Panel

12-320-L		55-59	\$159.95
12-320-R		55-59	\$159.95

Door Panel Screw Set

12-324-55	stainless steel screws # 10 & ¼ 24UNC per door	55-55	\$9.95
-----------	--	-------	--------

12-0324-56	26 pc stainless steel screws ¼- 20 UNC--- 2 doors	56-66	\$26.95
------------	---	-------	---------

12-0324-56OE	26pc OE style recessed head-zinc plated	56-66	\$24.95
--------------	---	-------	---------

12-0851	Nuts- to replace missing or damaged door panel pair	56-71	\$1.55
---------	---	-------	--------

Bill's Truck Shop

Phone (905) 725-3460 / (905) 725-2022



13-0PW-HS



Power Windows- includes chrome switches, wiring harness, US made Sieman motors on original style window regulators w/ complete instructions- Brass iolite thrust bearings at pivots-mfg. by Nu-Relics

13-359-PW	w/chrome switches	55-59	\$999.95
13-359-PW/CS	w/ crank handles switches	55-59	\$999.95

Crank Handle Switches

13-0PW-HS	check shaft length	pair	40-72	\$225.00
-----------	--------------------	------	-------	----------

One Piece Glass

See product info below

1955-59	Power window kit w/ 1 pc glass	Inquire
13-3PW-1T		

Bill's Truck Shop

Phone (905) 725-3460 / (905) 725-2022

This electric kit includes the following for the 1955, 56, 57, 58, and 59 Chevy truck: 2 side windows - choose color, 2 lower glass run channels and 2 electric lift channels attached to window glass, 2 front vent channels with 2 brackets, screws and nuts, 2 upper U felts (bent to fit), 4 lower felts with clips installed, left and right motor with left and right installed brackets, left and right switches with complete wiring and door post wire guides. Easy to follow written instructions with pictures. These are tempered glass only w/ Specialty Power windows drive system

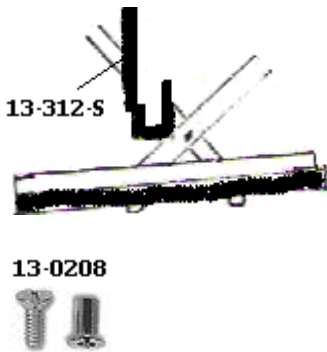
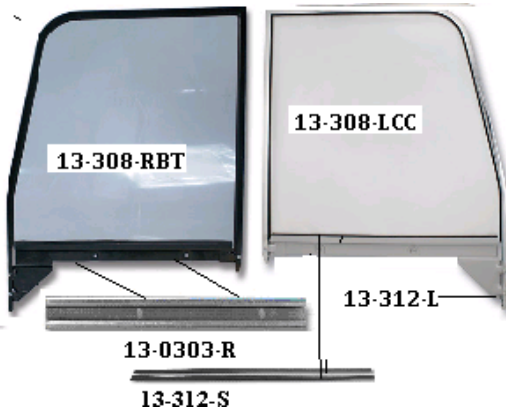

Door Glass Frame w / glass & sash-----new assembly DO NOT come w/ sash seal # 13-312-S

13-308-LCT	chrome	w/tinted glass	left	55-59	\$329.95
13-308-RCT	chrome	w/ tinted glass	right	55-59	\$329.95
13-308-LCC	chrome	w/clear glass	left	55-59	\$329.95
13-308-RCC	chrome	w/clear glass	right	55-59	\$279.95
13-308-LBT	black	w/tinted glass	left	55-59	\$329.95
13-308-RBT	black	w/tinted glass	right	55-59	\$329.95
13-308-LBC	black	w/clear glass	left	55-59	\$329.95
13-308-RBC	black	w/ clear glass	right	55-59	\$329.95

Door Glass Frame Screws (barrel nut & screw)

13-0208		each	47-63	\$1.50
---------	--	------	-------	--------

Door Glass Sash- steel frame on lower glass (each)

13-312-L		left	55-59	\$59.95
13-312-R		right	55-59	\$59.95

Window Regulator Roller Guide Rail

13-0303-R		fits L and R	each	55-63	\$44.95
-----------	--	--------------	------	-------	---------

Screw –window guide to sash kit- 4 screws w/ washers

13-0303-SK		both sides		55-63	\$3.95
------------	--	------------	--	-------	--------

Door Glass Sash Seal

13-312-S	& secures glass into sash	each	55-59	\$10.95
----------	---------------------------	------	-------	---------

13-313-TLC



13-0213-S



13-313-SK



Vent Window Assembly

13-313-TLC	tinted glass w/ chrome vent frame-left	55-59	\$559.95
13-313-TRC	tinted glass w / chrome vent frame-right	55-59	\$559.95
13-313-CRC	clear glass w/ chrome vent frame-right	55-59	\$559.95
13-313-CLC	clear glass w/ chrome vent frame-left	55-59	\$559.95

NOTE-adjust vent post tension spring before installation

Vent Window Ass install kit-2 doors

13-313-SK	stainless steel	55-59	\$6.95
-----------	-----------------	-------	--------

13-314-LC	left w/o glass chrome	55-59	NLA
13-314-RC	right w/o glass chrome	55-59	\$79.95

Spring-Vent Window Frame Tension Spring

13-0213-S		51-91	\$11.95
-----------	--	-------	---------

Bill's Truck Shop

Phone (905) 725-3460 / (905) 725-2022

Fuel Tank & Parts

Due to the fluctuation of the Canadian and American dollars call for current prices

Group 14



		<u>Year</u>	<u>New</u>
Gas Tank-galvanized 18gal			
14-301	pickup	55-59	\$399.95
14-301-PS	suburban / panel	55-59	
Gas Tank Straps			
14-301-S	pair	55-59	\$69.95
Gas Tank Strap bolt kit			
14-301-SHK	4 bolts w/ washers	55-59	\$5.95
Gas Tank Insulator kit			
14-0GTP	2" x 40" pair	47-66	\$9.95
Gas Tank Filler kit			
14-302-K	includes pipe-hose-grommet-cap	55-59	\$114.95
Gas Tank Floor Seal Donut -seals between gas tank and fuel line/drain hole in floor			
14-0305		49-59	\$4.95
Gas Tank Filler Neck Pipes			
14-302	pickup	55-59	\$49.95
Gas Tank Filler Neck Grommet			
14-302-3	pickup	55-59	\$8.95
Gas Tank Filler & Vent Hose-clamps not included			
14-0212	also fits 55-59 panel & sub 2pcs	49-59	\$21.95
Gas Tank Filler Hose Clamp			
14-0212-C	correct OE style 4pcs	49-59	\$12.95
14-0212-S	screw type hose clamps	49-59	\$8.25
Fuel Line Grommet			
6-0510-GS	OD 1-ID3/4-w/ 3/8 hole - at floor	49-71	\$4.95
Gas Tank Sender Wire Grommet			
14-0415	OD 1 -ID 11/16 w/5/16 hole - at floor	49-59	\$2.95
Flexible Fuel Line under tank			
14-0203-3		54-59	\$31.95
Fuel Tank Line			
14-303-L	5/16 line w/ fittings	55-59	
Fuel Fill Delete plate			
14-00GD	weld in/when relocating fuel tank	55-66	\$23.95

Bill's Truck Shop

Phone (905) 725-3460 / (905) 725-2022



				<u>Year</u>	<u>New</u>
Gas Tank Sender Unit w/ gasket					
14-304	w/ fuel pickup	30 ohm	pickup	55-59	\$64.95
Fuel Sender for -14-300-K tank					
14-0204-90	universal application	90 ohm			\$64.95
14-0204-30	universal application	30 ohm			\$64.95
Fuel Sender Pickup Screen					
6-0204-S	OE metal type	for 5/16 line		54-72	\$28.95
Gas Tank Sender Unit Gasket					
14-0593				47-66	\$2.95
Gas Tank Sender Screw Kit					
14-0594				47-66	\$2.95
Gas Tank Sender Float					
6-0204		brass		47-72	\$11.95
Fuel Door Bumper					
6-0210	panel & suburban		pair	55-59	\$4.00
Gas Cap – Original Type vented					
6-0GCS	stainless steel	NEW PRICE!!		47-70	\$18.95
6-0GCP	paint to match			47-70	\$27.00
Locking Gas Cap—non vented					
14-0416	chrome w/ bowtie lock cover			47-70	\$74.95
14-0417	chrome -smooth w/2 keys			47-70	\$22.95
Cool Cap					
14-0FCC	flush mount, billet aluminium, screw cap w/ 1 1/2 fill neck, 3" flange	NON venting			\$104.95
14-00FH	fuel hose/ neoprene 4" long x 1 1/2 ID w/ clamps				\$16.95

Bill's Truck Shop

Phone (905) 725-3460 / (905) 725-2022

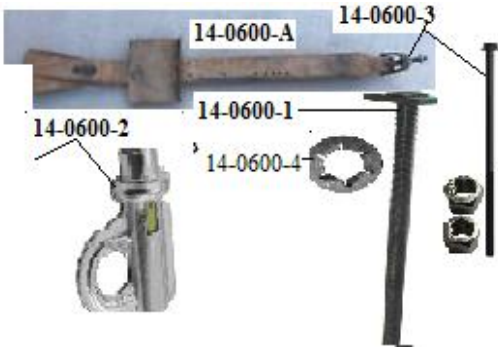

SPARE TIRE HARDWARE

Grommet

14-0610 for support brace in fender –short step side trucks fits 1 3/4 hole

Year New

14-0600-1	bolt –support release bolt	54-87	\$37.95
14-0600-2	nut-lock bolt nut w/ nylon insert	54-87	\$12.95
14-0600-3	bolt-tire support pivot	54-87	\$22.95

55-66 \$7.95

Check our website www.billstruckshop.com for California trucks and parts

Bill's Truck Shop

Phone (905) 725-3460 / (905) 725-2022



Front glass are laminated / rear and side glass are tempered all glass DOT approved

Year New

Windshield

15-301-C	clear (special order-10 days)		55-59	\$449.95
15-301	tinted only -NO upper shade		55-59	\$449.95
15-301-T	tinted w/ shaded top		55-59	\$449.95

Door Glass—requires seal # 13-312-S to install in sash

15-303-C	clear	each	55-59	\$69.95
15-303-T	green tint	each	55-59	\$69.95
15-303-G	gray tint		55-59	\$79.95

Vent Glass

15-305-C	clear		55-59	\$54.95
15-305-T	green tinted		55-59	\$54.95
15-305-G	gray tint		55-59	\$54.95

Uses 1-0GST-1 on vent glass install

Back Glass

15-306-SC	small clear		55-59	\$139.95
15-306-ST	small tinted		55-59	\$139.95
15-306-SG	small gray tint		55-59	\$159.95
15-306-LC	large clear		55-59	\$399.95
15-306-LT	large tinted		55-59	\$469.95
15-306-LG	large grey tinted		55-59	\$424.95

Rear Barn Door Glass-panel/suburban

15-307-CL	clear/left		55-59	\$69.95
15-307-CR	clear/right		55-59	\$69.95
15-307-TL	green tint/right		55-59	\$144.00
15-307-TR	green tint/right		55-59	\$144.00

Bill's Truck Shop

Phone (905) 725-3460 / (905) 725-2022

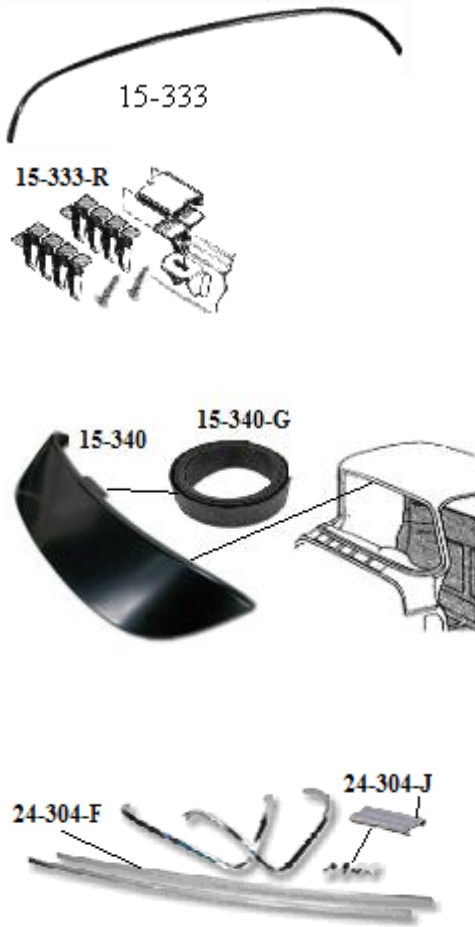

		<u>Year</u>	<u>New</u>
Windshield Dash Trim -lower			
15-333		55-59	\$124.95
Windshield Dash Trim Retainer set			
15-333-R	w/ screws	55-59	\$16.95
Outside Sun visor			
15-340	steel w/hardware	55-59	\$249.95
15-340-G	roof to visor gasket	55-59	\$13.95
Windshield Trim			
<i>inquire on individual used pieces</i>			
24-304-F	stainless trim in front glass seal - set	55-59	\$229.95
24-304-J	stainless jointers for glass trim - each	55-59	\$3.95

Bill's Truck Shop
 Phone (905) 725-3460 / (905) 725-2022



			<u>Year</u>	<u>New</u>
Parklamp Lens				
16-303-GMC-CL	GMC clear-	left	55-57	\$29.95
16-303-GMC-CR	GMC clear-	right	55-57	\$29.95

Parklamp Lens Gasket (pair)				
16-303-G		GMC - pair	55-57	\$13.95

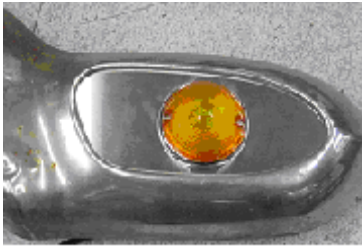

Park lamp Housing Assembly w/ harness & lens				
16-301-HC	Chev/ with clear lens	- each	55-57	\$49.95
16-301-HA	Chev/ with amber lens	- each	55-57	\$49.95



16-303-SK	4 stainless screws----	GMC	55-57	\$2.95
-----------	------------------------	-----	-------	--------

Park lamp Housing Assembly w/ harness & lens				
16-303-HA	GMC	-each	55-57	

16-304-L	OE assembly	left	58-59	\$334.95
16-304-R	OE assembly	m right	58-9	\$334.95



16-0428

Socket-signal & brake				
16-0428	2 wire for signal-brake & running light-	accepts 2 pin 1157 bulb	each	\$7.95

Bill's Truck Shop

Phone (905) 725-3460 / (905) 725-2022

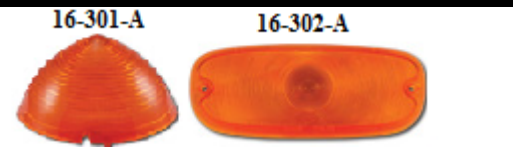

			<u>Year</u>	<u>New</u>
Parklamp Lens				
16-301-C	Chev clear-	each	55-57	\$9.95
16-301-A	Chev amber	each	55-57	\$9.95
16-302-C	Chev clear	each	58-59	\$9.95
16-302-A	Chev amber-	each	58-59	\$9.95
Park lamp Screw set				
16-302-SK	4 stainless screws --Chev		58-59	\$295
Park lamp Housing Assembly w/ harness & lens				
16-301-HC	Chev/ with clear lens	- each	55-57	\$49.95
16-301-HA	Chev/ with amber lens	- each	55-57	\$49.95
16-302-HC	Chev /with clear lens	-each	58-59	\$89.95
16-302-HA	Chev/ with amber lens	-each	58-59	\$89.95
Parklamp Lens Gasket (pair)				
16-301-G		Chev - pair	55-57	\$6.95
16-302-G		Chev - pair	58-59	\$5.50
Park lamp Housing to Fender Gasket				
16-301	Chev	pair	55-57	\$6.95
Park lamp Bezel				
16-302-B	Chev chrome L or R	each	58-59	\$84.95
Park lamp Harness Grommet				
16-305-G	1 each side of rad support	pair	55-59	\$5.75
Socket-signal & brake				
16-0428	2 wire for signal-brake & running light- accepts 2 pin 1157 bulb	each		\$7.95
Roof Light Kit				
17-0033-K	5 lights w/ harness,switch & bulbs			\$224.95

Bill's Truck Shop

Phone (905) 725-3460 / (905) 725-2022



Headlamps		Year	New
16-0206-12	12 volt Halogen		\$23.95
16-05001H	GMC high (inner) Halogen each	58-72 GM 60-62 Che	\$22.95
16-05006H	GMC high/low (outer) Halogen each	58-72 GM 60-62 Che	\$22.95

Headlight Bezel Screws= stainless steel

16-355-S	6 pcs	55-57	\$2.50
16-358-S	8 pcs	58-59	\$2.95

Headlamp Bezel Seals w/ wire core as original

16-0207-1	pair	47-57	\$23.95
-----------	------	-------	---------

Headlamp Bulb Retainer Ring-

16-3HR	stainless steel w/o hold down ears	55-57	\$26.95
19-0HR-2	58-61 Chev & 58-64 GMC w/ 2 retainer tabs each	58-64	\$16.95

Headlamp Bulb Retainer Ring Screws

12-0HRS-6		47-87	\$5.95
-----------	--	-------	--------

Headlamp Adjusting Screws and Nut

16-0207-A	1 screw w/ threaded nylon nut	47-57	\$4.95
16-0432	1 adjuster w/hdw	58-61	\$3.95

Headlamp Adjuster Spring w/ hdw

16-0207-S	each w/ hdw	47-59	\$4.95
-----------	-------------	-------	--------

Headlight Ring Support/Post

16-0208	secures to light pot lower w/ hdw	each 47-57	\$8.95
---------	-----------------------------------	------------	--------

Headlamp Bucket to Fender Gaskets

16-0515		pair 47-57	\$11.95
16-315-58	black sealer/caulking strips	set 58-59	\$12.95



			<u>Year</u>	<u>New</u>
Headlamp Bucket to Fender mount kit				
16-307-7	screws w/ j nuts	16pcs	55-57	\$10.95
16-307-9	screws only	14pcs	58-59	\$4.95
Headlamp Cup for head light				
19-0422	headlight cup	each	41-55/62-72	\$44.95
12-0HR-1	headlight retainer	each	41-55/62-72	\$19.95
The following "cups" fit 58-61 Chev and 58-66 GMC -includes retainer ring				
16-0307-1	outer / left -drivers side		58-66	\$42.95
16-0307-2	inner / left- drivers side		58-66	\$42.95
16-0307-3	outer / right - pass side		58-66	\$42.95
16-0307-4	inner / right - pass side		58-66	\$42.95
Note-cups are stamped w/ "1 for inside and "2 for outside w/ L for left and R for right -headlight must sit vertical				
16-0307-K	4 cups w/ rings		58-62	\$169.95
Headlamp Bucket Assembly-				
16-355-HA	w/ universal harness w/o bulb	-each	55-57	\$99.95
16-355-HAB	w/ OE style harness, hdw & 12V seal beam		55-57	\$189.95
Headlamp Bezel Stands—w/ rivets--sold as each -up R is the in on L///// up L is the in R				
16-358-UL	upper bezel stand--outer R/ inner L		58-59	\$9.95
16-358-UR	upper bezel stand-inner right/outer R		58-59	\$9.95
16-358-L	lower bezel stand		58-59	\$6.95
16-358-K	4 pc kit w/ hdw for 1 side		58-59	\$33.95
Headlamp Bucket Wire Grommets				
17-0721		pair	47-57	\$5.95
17-300	one per housing	pair	58-59	\$20.95
Headlight Wiring Inner Fender Grommet				
17-0201	hole diameter 3/4 "	pair	47early56	\$3.95
17-301-56	hole size 1 3/8 w/ 2 hole grommet	each	late 56-57	\$2.95
17-301-58	single 15/16 hole in inner fender -	pair	58-59	\$4.95
Headlight Wiring Loom Black fabric over wire as original				
18-0WL-1	1/4 ID	per foot		\$1.95
18-0WL-3	3/8 ID	per foot		\$1.95
18-0WL-5	1/2 ID	per foot		\$1.95

Bill's Truck Shop

Phone (905) 725-3460 / (905) 725-2022

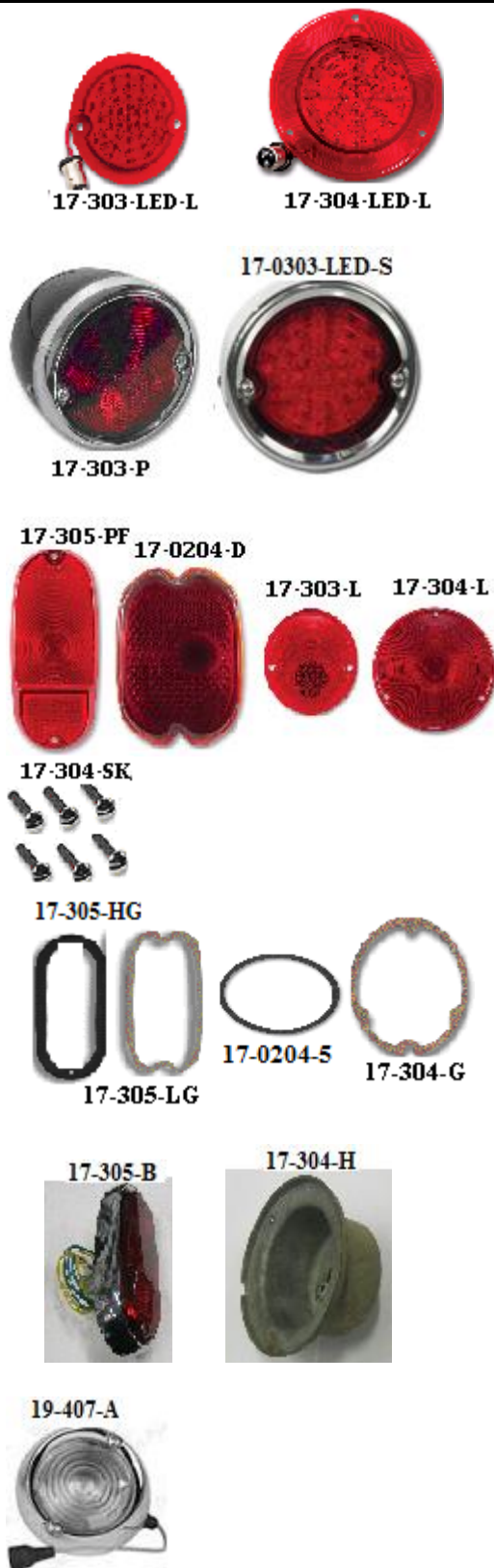

			<u>Year</u>	<u>New</u>
Tail lamp Assembly with Wiring –stepside				
17-303-P	painting w/ stainless steel bezel	each	55-59	\$68.95
17-303-S	stainless steel	each	55-59	\$79.95
Tail lamp Assembly w/ LED lightning				
17-0303-LED-S	stepside stainless steel housing w/wiring - each		54-59	\$104.95
17-0303-LED-P	stepside-black w/ housing w/ wiring each		54-59	\$94.95
Tail Lamp Lens—LED includes harness w/ socket				
17-304-LED-L	fleetside-LED lens fits OE housing-each		58-59	\$64.95
17-303-LED-L	stepside LED lens fits OE housing - each		55-59	\$69.95
17-303-L	stepside	each	55-59	\$7.95
17-304-L	fleetside	each	58-59	\$10.95
Tail Lamp Lens Screw kit-if holes are enlarged insert some wire for screws to tighten				
17-304-SK	stainless steel-fleetside	6 pcs	58-59	\$2.00
17-305-SK	stainless steel-panel #8-32	4 pcs	56-59	\$1.00
Tail Lamp Lens—Panel or Suburban				
17-0204-D	oval red w /barn doors only		47-56	\$21.95
17-305-PF	plastic on fender	each	55-59	\$26.95
Tail lamp Lens Gasket				
17-0204-5	stepside	pair	55-59	\$4.50
17-304-G	fleetside	pair	58-59	\$9.95
17-0204-6	subur/ panel truck w/oval lens w/ taillight on rear door w/ side by side doors only		47-56	\$4.95
17-305-LG	suburban/panel w/ lights on ¼ panel	pair	55-59	\$7.95
Taillamp Body Mount Gasket – rubber				
17-305-HG	suburban/panel w/ lights on ¼ panel	pair	55-59	\$14.95
Taillight Assembly suburban/panel on ¼ panel				
17-305-B	chrome housing w/ plastic lens & stub harness left & right are the same –rotate lens for other side	each	56-59	\$74.95
Taillight Housing				
17-304-H	fleetside	each	58-59	\$59.95
Reverse Light Assembly can install 60-66 rev light assembly on 58-59 fleet side box below brake light				
19-407-A	reverse light assembly	each	60-66	\$94.95

Bill's Truck Shop

Phone (905) 725-3460 / (905) 725-2022



			<u>Year</u>	<u>New</u>
Tail lamp Bezel				
17-303-B	stainless steel –stepside	each	55-59	\$10.95
17-304-B	aluminium – fleetside	each	58-59	\$36.95
17-0205-2	chrome sub/panel truck w/oval lens w/ side by side doors only		47-56	\$33.95
Tail lamp Wire Conduit / stainless steel				
17-0208	18 in long	pair		\$19.95
Taillamp Bracket				
Painted				
17-0510-BL			55-66	\$11.95
17-0510-BR			55-66	\$11.95
Chrome				
17-0510-CR			55-66	\$19.95
17-0510-CL			55-66	\$19.95
Taillight Bk Bolt kit				
17-0510-KA	philips drive w/ washer-stainless steel	8 pc kit	54-72	\$7.95
17-0510-KB	7/16 hex head w/ washer-stainless steel	8 pc kit	54-72	\$7.95
Taillamp Assembly Mount Pad-between light housing and bracket				
17-0206-P	moulded rubber pad		47-56	\$69.95
Taillamp Harness Grommet- w/ side by side doors				
17-0206-G	in door behind housing		47-56	\$2.50
License Light Lens				
17-0206-L			47-56	\$39.95
License Lens Gasket - w/ side by side doors				
17-0206-LG			47-56	\$1.75
Hood Light Kit				
15-0HL	OE accessory kit		47-72	\$69.95

Bill's Truck Shop
 Phone (905) 725-3460 / (905) 725-2022

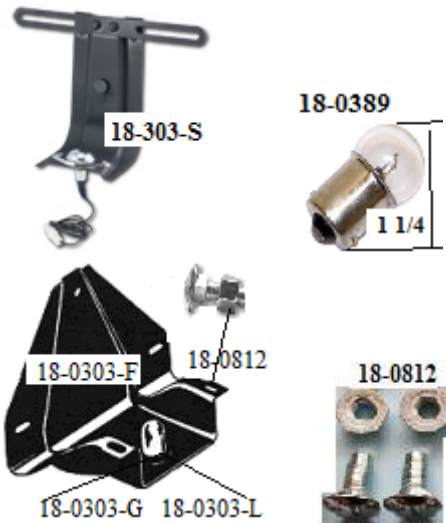

		<u>Year</u>	<u>New</u>
License Plate Bracket & Lamp Assembly			
18-303-S	stepside –secures to rear cross sill	54-59	\$59.95
18-0303-F	fleetside-mounts to bumper	58-66	\$69.95
18-0812	plate bkt bolts- stainless capped bolt @ bumper pair	58-66	\$9.95
18-0303-L	plate light lens-glass	58-66	\$9.95
18-0303-G	plate light lens- gasket	58-66	\$2.00
18-0303-U	mount @ rear cross sill w/ no rear bumper	54-87	\$19.95
18-0389	bulb-plate light-single contact-level pins 12V 6 CP each		\$1.95

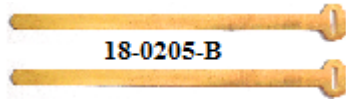

Wire Harness Clips			
18-0205-S	for sheet metal	each	47-72 \$1.95
18-0205-OE	OE style frame harness clip	each	41-59 \$3.79
18-0205-F	at frame locations	each	47-72 \$1.95
37-0315	insulated clamp style w/ hdw	pair	\$3.75
18-0205-B	OE brass tie straps used to secure wiring harness and washer hose under the dash and engine bay	pair	55-62 \$9.95



Wiring Loom black fabric as original			
18-0WL-1	¼ in diameter.	Per foot	\$1.95
18-0WL-3	3/8 in diameter	Per foot	\$1.95



Wiring Conduit –plastic, black, ribbed, split wiring covering			
18-0WC-1	¼ in dia	Per foot	\$1.19
18-0WC-3	3/8 in dia	Per foot	\$1.95
18-0WC-5	½ in dia	Per foot	\$1.15



Wiring Plug w/ grommet @ connectors			
18-0547	universal 8 plug pass through connector kit		\$22.95

Bill's Truck Shop

Phone (905) 725-3460 / (905) 725-2022

17-0208-B



18-304-A

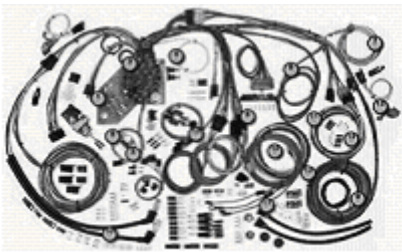

18-3481

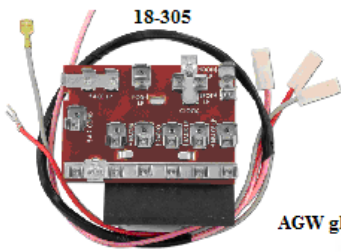

18-305

heater-----20 amp
radio-----5 amp
backup-----10 amp
brake-----20 amp
spot-----10 amp
fog-----10 amp
AC-----25 amp

AGW glass fuses 1/4 x 7/8

18-0023-A



18-0832



Wiring Harness –PVC coated copper wiring in the correct colour code to replace the original wiring. Complete front to rear W/ detailed instructions. 6 or 8 cyl-
Gen harness to use with Original system & Alt w/ internal regulator type –NOT a direct fit for GMC some modifications required for GMC-fleetside require 2 x 17-0208-B

		Year	New
18-304-G	w/ generator	55-59	\$579.95
18-304-A	w/ alternator	55-59	\$499.95

Taillamp Socket w/ Wire & Rubber Boot

17-0208-B	taillights	each	47-66	\$10.95
-----------	------------	------	-------	---------

Custom Classic Updated Wiring Harness kit- by American Autowire

An excellent replacement updated wiring harness w/ blade type 18 fuse –21 circuit –includes plugs, switches for original or aftermarket gauges-HEI or point type dist harness- column connectors for stock or updated columns-front, rear & dome, under dash light harness-updates for original or AC updates, power windows, seats, stereo, electric fuel pumps etc-includes complete instructions, grommets, connectors, fuses, flasher extra wiring ties

18-3481			55-59	\$1349.95
---------	--	--	-------	-----------

Fuse Block

18-305	w/ primary wiring & instructions		55-59	\$79.95
--------	----------------------------------	--	-------	---------

When adding electric wipers and using w/ fuse panel-power can also be supplied through AC fuse terminal OR ignition switch w/ pre-fused wipers

Fuses----- all acc fuse panel fuses are ¼ x 7/8 long AGW glass fuses

AG Fuses Originally stood for “all glass.” The automotive industry uses the “AG” prefix (AGC, AGW) for most glass fuses. They vary in length, diameter and amperage rating.

18-0674-25	25 amp	each		\$0.99
18-0673-20	20 amp	each		\$0.99
18-0671-10	10 amp	each		\$0.99
18-0670-5	5 amp	each		\$0.99

Accessory fuse panel

18-0023-A	6 pin/uses ATO spade fuses			\$39.95
-----------	----------------------------	--	--	---------

Fusible Link

18-0832 9“ 12 gauge slow burn wire- fuse wire is usually 4 gauges smaller then circuit wire w/ connectors-excellent safety precaution installed to ignition feed wire at starter approx. 20-25 amps---add to starter-ignition dash feed

\$3.50

Bill's Truck Shop

Phone (905) 725-3460 / (905) 725-2022

WIRING HARNESS

Due to the fluctuation of the Canadian and American dollars call for current prices

Group 18

		<u>Year</u>	<u>New</u>
All apply to OE application-CHEV----- special order only -will quote cost at time of order			
Headlamp Harness –lamps to connector-pr			
	18-307-55H	55-57	\$49.95
	18-307-58H	58-59	\$49.95
	18-307-58H-OE w/ original style low profile seal beam connectors	58-59	\$114.95
Socket-headlamp harness repair			
	16-0001 3 wire each		\$4.50
Front light harness			
	18-3045		
	16-0001		
	18-3158		
	18-310-G		
	18-3430		
	18-3750		
18-3350	6 cyl w/ stock generator 12 volt	55-55	Inquire
18-3035	V8 w/stock generator 12 volt	55-55	Inquire
18-3415	V8 w/stock generator	56-56	Inquire
18-3400	6 cyl w/stock generator	56-56	Inquire
18-3045	6 cyl w/ stock generator & signals	56-56	Inquire
18-3030	V8 w/stock generator & signals	56-56	Inquire
18-3555	w/ stock generator	57-57	Inquire
18-3040	w/stock generator & signals	57-57	Inquire
18-3860	w/ stock HD generator	57-57	Inquire
18-3805	w/stock HD generator	58-58	Inquire
18-3715	w/stock generator	59-59	Inquire
18-3055	w/ stock generator & signals	58-59	Inquire
Rear Body Harness			
18-3158	Cameo only	55-55	Inquire
18-3370	w/ brake, tail & signal lights	55-55	Inquire
18-3155	extension w/ long bed/pair	55-59	\$31.95
18-3164	Cameo only	56-56	Inquire
18-3350-A	w/ brake, tail & signal lights requires #18-3155 w/ long bed	56-56	\$31.95
18-3166	Cameo only	57-58	Inquire
18-3150	w/ brake, tail & signal lights-requires #18-3155 w/ long bed	57-59	\$151.95
Grommet-@ rear frame crossmembers			
18-310-G	protects harness to rear	each 55-59	\$3.25
Transmission Overdrive			
18-3280	w/ V8	55-56	Inquire
18-3545	w/ V8	57-57	Inquire
Turn Signal Harness			
18-3365	dash side	55-55	Inquire
18-3430	engine side	55-55	Inquire
18-3360	dash side	56-56	Inquire
18-3570	engine side	56-56	Inquire
18-3355	dash side	57-59	Inquire

Bill's Truck Shop

Phone (905) 725-3460 / (905) 725-2022



18-3290



15-0HL



19-0655-K



19-0655-K-C

All apply to OE application-CHEV----- special order only -will quote cost at time of order

Engine / Starter Harness-all w/ generator			
18-3400-A	6 cyl w/ auto trans 12 V	55-55	Inquire
18-3395	6 cyl w/ manual trans 12 V	55-55	Inquire
18-3285	8 cyl w/ auto trans 12 V	55-55	Inquire
18-3385	8 cyl w/ manual trans 12 V	55-56	Inquire
18-3290	V8 w/auto trans & HEI	55-56	Inquire
18-3295	V8 w/manual trans & HEI	56-56	Inquire
18-3395-A	6 cyl w/ auto trans	56-56	Inquire
18-3390	6 cyl w/ manual trans	56-56	Inquire
18-3405	V8 w/auto trans	56-56	Inquire
18-3425	V8 w/ manual trans	57-57	Inquire
18-3570-A	6 cyl w/ auto trans	57-57	Inquire
18-3550	6 cyl w/ manual trans	57-57	Inquire
18-3560	V8 w/ auto trans	57-57	Inquire
18-3565	V8 w/ manual trans	57-59	Inquire
18-3310	V8 w/ auto trans & HEI	57-59	Inquire
18-3315	V8 w/ manual trans & HEI	58-59	Inquire
18-3910	6 cyl w/ auto trans	58-59	Inquire
18-3905	6 cyl w/ manual trans	58-59	Inquire
18-3735	V8 w/ auto trans	58-59	Inquire
18-3810	V8 w/ manual trans	58-59	Inquire
18-3790	V8 w/ manual & over speed		Inquire
governor light			

Dash Harness

18-3465	w/ 12 volt	55-56	Inquire
18-3750		57-59	Inquire

Under Hood Lamp---early 1960 GM reproduction option



15-0HL		\$69.95
--------	--	---------

Ground Strap kit

19-0655-K	3x 9" & 2 x 11" steel straps	\$39.95
19-0655-K-C	2 x 9" & 2x 11 " copper straps	\$17.95

Bill's Truck Shop

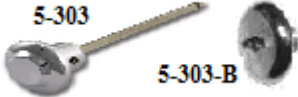
Phone (905) 725-3460 / (905) 725-2022

			<u>Year</u>	<u>New</u>
	18-307			
	Headlamp Switch			
	18-307	OE style w/ fuse NO rod & knob	55-59	\$62.95
	18-0332	must be used when adding halogen lights to carry increased amp load –includes “3 sided” shaped rod, aluminum knob and retainer –can use #36-309 radio knob to match other dash knobs	47-59	\$49.95
	18-207-12U			
	18-207-12U	Headlight Switch-12V universal application w/rod & chrome knob --screw on pins	47-59	\$37.95
	Headlamp Switch Retainer/Bezel			
	5-303-B		55-59	\$16.95
	Light Knob and Rod			
	5-303	Chev w/ chrome knob	55-59	\$22.95
	5-303-W	GMC w/ white knob	55-59	
	18-0332			
	17-0045			
	Terminal Block	–secures to rad support on GMC truck		
	17-303-3	3 pin w/o signals lights	each 55-59	\$11.95
	17-303-4	4 pin w/ signals lights	each 55-59	\$21.95
	Accessory Switch	–vintage style –under dash mount		
	OE 1955 GMC sample picture			
	17-303-3	fused/rotary any acc lamps w/20 amp fuse–illuminated when on		\$24.95
	17-303-4			

Bill's Truck Shop

Phone (905) 725-3460 / (905) 725-2022



		<u>Year</u>	<u>New</u>
Dimmer Switch w/ screws			
18-308-55	push on staggard terminal	55-56	\$28.95
18-308-57	push on pins-"T" position	57-60	\$29.95
Dimmer switch -screw kit			
18-0305	2 pcs	39-61	\$1.00
Horn Relay			
18-0209	6 or 12 V w/ screw on terminals	41-56	\$44.95
18-0309-57	push on terminals	57-62	\$39.95
Horn			
18-0210-6	6 volt inquire about original horns		
Chev OR GMC	high or low tone	55-59	
14-042-H	12V high tone -universal	47-87	\$32.95
14-042-L	12V low tone - universal	47-87	\$32.95
Turn signal Switch Assembly			
18-0551-U	universal column mount w/4-way& instructions-requires 3 pin flasher	47-59	\$64.95
Note-----54-56 signal bowl signal lever exits straight out and 58-59 comes out on upper angle			
18-0211	in upper bowl-has loose harness connectors	55-56	\$39.95
18-311-57	in upper bowl w/ plug adaptor for harness	57-59	\$42.95
Turnsignal Housing Assembly w/ signal switch- does not include signal lever # 5-305-1			
18-0311-54H	original cup type on column	54-56	\$199.95
18-311-57H	original cup type on column	57-59	\$199.95
Turn Signal Housing Wedge			
18-0211-W	locks signal bowl to column	54-59	\$3.75
Signal Flasher Plug and Harness & Bracket			
18-213-P			\$55.95
Turn signal Flasher			
18-0213-F6	6 volt 3 pin		\$29.95
18-0213-F12-L	12 volt 3 pin-use w/ LED lights		\$18.95
18-0213-F12-L2	12 volt 2 pin-use w/ LED lights w/ ground wire		\$26.95
18-0213-F12	12 volt 3 pin		\$21.95
14-0SF-12	12 volt 2 pin		\$6.95
14-0SF-12HD	12 volt HD electronic		\$14.95
Turn signal Switch Cancel Plate			
18-0214	Cancel original type turn signals.	54-59	\$5.60
Turn signal Switch Cancel Plate install kit			
18-0214-HK	2 screws w/ washers	54-66	\$1.25

Bill's Truck Shop

Phone (905) 725-3460 / (905) 725-2022 / Fax (905) 404-2302 email: bill@billstruckshop.com



Ignition Switch w/o keys

18-301-55F	off & on position only for foot start	55-59	Inquire
18-301-55	V8/ key start—will accept 18-013 & 18-013-B cyl & key	55-56	\$79.95
18-301-57	V8 key start- will accept 18-013 & 18-013-B	57-59	\$99.95
18-0805	universal type- w/ aluminium retainer -5 pin w/ 4 position - key start —includes instructions w/ keys	55-66	\$59.95

Ignition Switch Harness

18-3444	Adapts the 57-59 OE harness to the 55-56 repro ignition switch	57-59	
---------	--	-------	--

Ignition Cylinder w/OE Style Keys

18-013	single hole for spring pi entry	47-66	\$23.99
18-013-B	extension allows for vehicle to be started w/o keys if not placed in lock position-also need keys to place in lock position- w/ 2 keys---2 hole for spring pin entry	47-66	\$25.95

Key-blank GM key

18-013-	BLANK ignition-door-glovebox	47-66	\$8.95
---------	------------------------------	-------	--------

Ignition Indicator Dial

18-301-D	w/ v8	55-59	\$15.95
----------	-------	-------	---------

Ignition Switch Bezel

18-301-OE	original style w/larger 1 9/16 outer dia	55-59	
18-301-B	1 3/8 outer dia	55-59	\$19.95

Starter Switch – at starter

18-0202-ST	w/ side terminal for 12 v ignition feed	38-59	\$29.95
18-0202	w/ out side terminal	38-59	\$32.95

Push Button Start Switch

18-0TB2	dash mount push button start switch-w/ aut trans or electric start solenoid 15A@12V 5/8 shaft dia		\$19.95
---------	---	--	---------

Brake Light Switch w/ screws

18-304		55-59	\$13.95
--------	--	-------	---------

Brake Switch Screw kit

18-0217	pair	42-59	\$1.00
---------	------	-------	--------

Upper Column Bearing w/ Horn Wire







18-0311		47-59	\$94.95
---------	--	-------	---------

Horn Wire Cover @ lower column

18-0211-C		47-59	
-----------	--	-------	--

Bill's Truck Shop

Phone (905) 725-3460 / (905) 725-2022 / Fax (905) 404-2302 email: bill@billstruckshop.com

			<u>Year</u>	<u>New</u>
		Dash Bulb Socket		
		18-0DB-S USED OE metal socket w/ NEW harness	47-66	\$5.95
		18-0DB-SN new plastic replacement socket w/ ,6" wire	47-66	\$5.95
		Dash Bulb-wiring-to replace dash bulb wiring when insulation is broken away using your original metal socket		
		18-0DB-W	47-66	\$1.75
		Dash Bulb		
		18-0HB-6v smaller 7/16 head for high beam indicator		\$2.15
		18-0HB-12V smaller 7/16 head for high beam indicator		\$1.20
		18-0DB-6V 6 volt		\$1.95
		18-0DB-12v 12 volt		\$1.75
		Brake – Signal Light Bulbs		
		19-0179A amber / 3 CP 12 volts		\$2.75
		19-0179 clear / 3 CP 12 volts		\$1.75
		Temp Sender		
		19-0469 6 or 8 Cyl—1/2 x 14 NPT w/ gauges	56-72	\$45.95
		Dimmer Switch Plug		
		3-0DS-P 3 pin plug w/ connectors	57-83	\$7.95
		Fuses-barrel style 1 ¼ long		
		18-0003 3 amp		\$0.99
		18-0004 4 amp		\$0.99
		18-0005 5 amp		\$0.99
		18-0010 10 amp		\$0.99
		18-0015 15 amp		\$0.99
		18-0020 20 amp		\$0.99
		Ground Strap-tin coated copper wire		
		18-0170-8 8" 11 gauge w/ 3/8 eyelets		\$1.95
		Fuse Holder-accessory		
		18-0987 sealed w/ hdw & fuse- note fuse size		\$5.95
		Horn Button-column mount		
		18-0018 6 or 12V application		\$9.42
		Voltage Regulator w/ generator		
		Voltage Regulator		
		18-0210-12-25 12 volt w/ 25 amp gen	47-62	\$69.95
		18-0210-12-35 12 volt w/ 35 amp gen	47-62	\$69.95

Bill's Truck Shop

Phone (905) 725-3460 / (905) 725-2022



19-3555-TC



19-3555-T

19-3555-E



32-0105-R

19-3555-LL



19-3555-C



19-3555-H



Tailgate w/ handle openings

19-3555-T

Year

New

55-58

\$799.95

Tailgate Recoilers

32-0105-R Cameo gate or lift gates on Suburban
each --flat band/not cable

47-59

\$114.95

Tailgate Handles-pr

Tailgate Latch w/ handle

19-3555-LL left side

55-58

Inquire

19-3555-RL right side

55-58

Inquire

Tailgate Handle-pr

19-3555-H chrome

55-58

\$199.95

Tailgate Ear- for latch striker

19-3555-E L & R same each

55-58

\$34.95

Tailgate Cable- multi-strand cable w/ crimped ball ends and recoiler bkt

19-3555-C

pair

55-58

\$199.95

Bill's Truck Shop

Phone (905) 725-3460 / (905) 725-2022

	<u>Year</u>	<u>New</u>
		
19-3555-RC		
		
19-3556-B		
		
19-3556-S		
		
19-3556-H		
		
19-3556-SC		
		
19-3556-P		
		
19-3556-C		
		
19-3556-BA		
Spare Tire Carrier-fibreglass		
19-3556	55-58	Inquire
Spare Tire Carrier Bolts		
19-3556-B polishes stainless steel bolts for hinged center bumper section	55-58	Inquire
Spare Tire Carrier Supports		
19-3556-S pair	55-58	Inquire
Spare Tire Carrier Hinge		
19-3556-H	55-58	Inquire
Spare Tire Carrier Seal		
19-3556-SC around edge of fibreglass tub	55-58	Inquire
Spare Tire Inner Bumper Pan		
19-3556-P	55-58	Inquire
Spare Tire Clamp		
19-3556-C	55-58	Inquire
Spare Tire Bracket Assembly		
19-3556-BA	55-58	\$79.95

Bill's Truck Shop

Phone (905) 725-3460 / (905) 725-2022

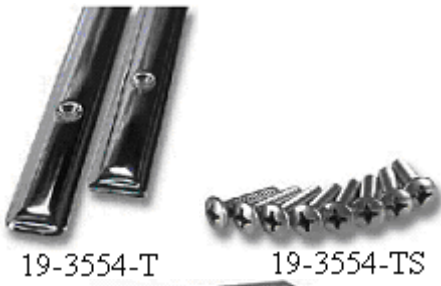

Bedside Letters- C A M E O

19-3758-C chromed/polished letters-set Year 57-58 New Inquire

Taillight Trim- u-shaped trim below taillight-2 pc per side-smooth finish to chrome or paint

19-3760-L left -pair 57-58 Inquire

19-3760-R right -pair 57-58 Inquire

Bedside Upper Mld-pr

19-3554-T 55-58 Inquire

Bedside Upper Mld Screw kit

19-3554-TS 55-58 Inquire

Bed front side mld are made from billet aluminum and polished-sold as pairs only

All Special Order

Bed Front Upper trim-pr

19-3555-TU 55-58 Inquire

Bed Front Middle Trim-pr

19-3555-TM 55-58 Inquire

Bed Front Lower Trim-pr

19-3555-TL 55-58 Inquire



19-3540-R

Bedsides-fibreglass outer skins

	<u>Year</u>	<u>New</u>
19-3540-L	55-58	Inquire
19-3540-R	55-58	Inquire

19-3542-R 19-3542-F



Filler panel –bedside front/fibreglass

19-3541-L	left	55-58	\$149.00
19-3541-R	right	55-58	\$149.00

19-3541-L



Bedside Supports-secures the fibreglass sides to prevent vibration-rear is shorter then ft made in Canada

19-3542-F	front left or right	each	55-58	\$22.95
19-3542-R	rear left or right	each	55-58	\$22.95



**BTS
EXCLUSIVE**

Braces-bed side set 5 per side

19-3543-B	fits L & R	55-58	\$174.95
-----------	------------	-------	----------

19-3543-B



28-0354-T

**Original style
28-0354-T
stepside**

**made w/ 16 gauge steel
Cameo-Carryall(GMC) and**

54-59	\$189.95
-------	----------

Rear Cross Sill

predrilled w/ support brackets
Cameo-Carryall(GMC) and

30-3715-T	stepside	55-59	\$199.95
-----------	----------	-------	----------



30-3715-T

Bill's Truck Shop

Phone (905) 725-3460 / (905) 725-2022

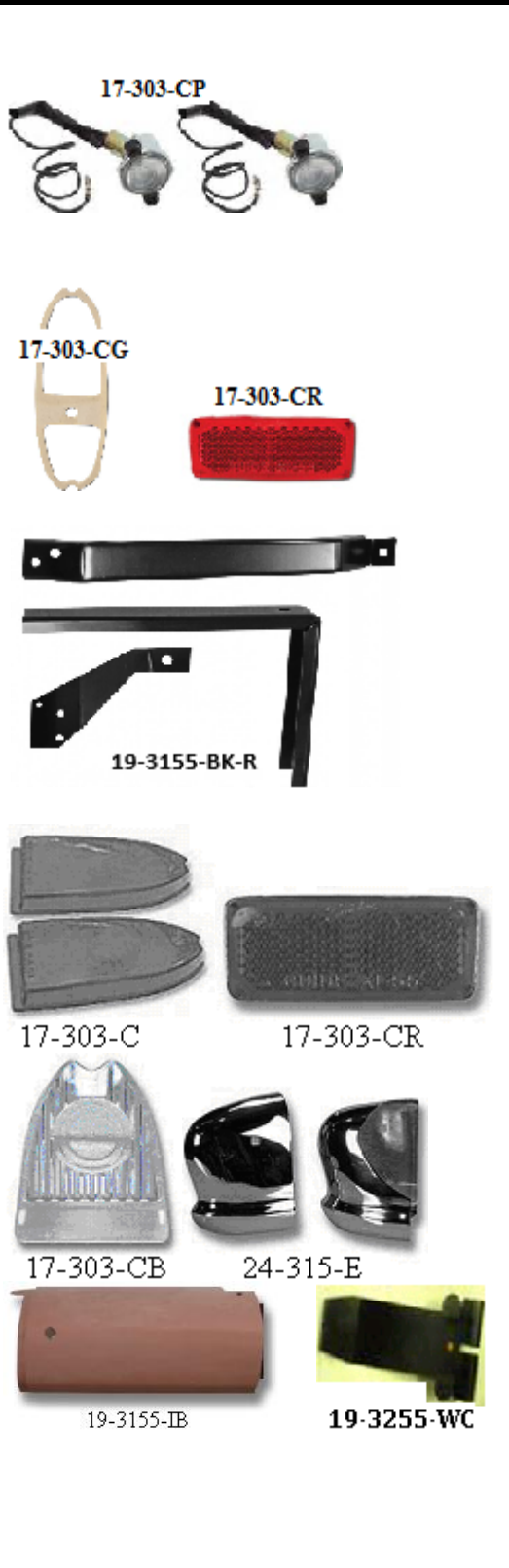

			<u>Year</u>	<u>New</u>
Taillight Lens Gasket				
17-303-CG	pair		55-58	\$9.95
Taillight Lens				
17-303-C	plastic	each	55-58	\$9.95
Tail lamp Reflector				
17-303-CR	tail lamp lens centre reflector	each	55-58	\$23.95
Backup Lens				
17-303-CB	reverse lens-plastic	each	55-58	\$24.95
License Plate Light kit-pr				
17-303-CP	housing-lens-wiring		55-58	\$59.95
Cameo Bumper Ends triple nickel plated chrome w/ support bracket				
19-3155-E		pair	55-58	Inquire
Cameo –rear bumper bkt set				
19-3155-BK-L	3 pc set w/ outer bumper brace-left		55-58	\$274.95
19-3155-BK-R	3 pc set w/ outer bumper brace-right		55-58	\$274.95
Trim Ring Clip				
19-3255-WC	metal clip w/ correct rubber bumper - 5 required per wheel	each	55-58	\$19.95

Bill's Truck Shop
 Phone (905) 725-3460 / (905) 725-2022

10-0204-BK



			<u>Year</u>	<u>New</u>
Armrest				
10-0204-R	red w/ beige bas	each	55-65	\$79.95
10-0204-BR	brown	each	55-65	\$79.95
10-0204-BK	black	each	55-65	\$79.95
10-0204-G	gray	each	55-65	\$79.95
10-0204-T	turquoise special order correct Haircell grain vinyl w/ exact Cameo seat cloth. Cut from factory patterns and sewn to duplicate the original. Kit includes bumper kit , door panel matching cloth , & door panel back boards.	each	55-65	\$79.95
19-3955-RI	Red & Ivory		55-58	Inquire
19-3955-BI	Beige & Ivory		55-58	Inquire
19-3955-BLI	Blue & Ivory		55-58	Inquire
19-3955-CI	Charcoal & Ivory		55-58	Inquire
19-3955-GI	Green & Ivory		55-58	Inquire
19-3955-TI	Turquoise & Ivory		55-58	Inquire

Bill's Truck Shop

Phone (905) 725-3460 / (905) 725-2022

Mirrors

Due to the fluctuation of the Canadian and American dollars call for current prices

Group 20



			<u>Year</u>	<u>New</u>
Mirror Arm Painted				
20-302-RP	right		55-59	\$39.95
20-302-LP	left		55-59	\$39.95
Mirror Arm Chrome				
20-303-RC	right		55-59	\$49.95
20-303-LC	left		55-59	\$49.95
Mirror Arm Gasket w/ moulded lip				
20-303-G	each		55-59	\$2.95
Mirror Arm Screw Set -R side will require nuts				
13-0MS	stainless steel	set of 3	55-70	\$5.95
13-0MS-A	OE collared style-philips drive-steel	set of 3	55-70	\$7.95
Outside Mirror Head				
When setting the mirror head for viewing loosen the 3 set screws on back of head & tighten when in desired location-this prevents scratching the pivot ball and future rusting-also lube w/ grease				
20-0PM	round/ribbed/painted		47-70	\$19.95
20-0CM	round/ribbed/chrome		47-70	\$25.95
20-0PRM	rectangular/painted		47-70	\$24.95
20-0SRM	rectangular/stainless		47-70	\$29.95
Peep Mirror Chrome Plated.				
mirror, bracket clamps on top edge of door.				
20-0PM-C	4" w/ curved arm-chrome	L or R		\$39.95
9-0PM-S	4" w/straight arm-chrome	L or R		\$37.95
Inside Mirror Head - Day/Night				
20-0206-DN	Chrome		54-59	\$69.95
Inside Mirror Head				
20-0306	Stainless Steel		54-59	\$39.95
Inside Mirror Bracket				
20-306-B	w/ screws		55-59	\$39.95
Vanity Mirror w/ C H E V R O L E T				
9-0VM	OE option	for sun visor	47-66	\$69.95

Bill's Truck Shop

Phone (905) 725-3460 / (905) 725-2022

Wipers

Due to the fluctuation of the Canadian and American dollars call for current prices

Group 21



21-301-55
5-304

21-0001



5-304-A



21-0201-S



5-304-B

21-0200



21-303-B



21-0303-L

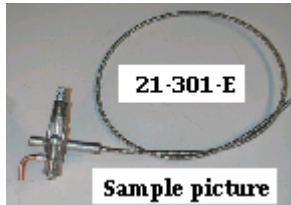

21-301-E

Sample picture



21-302-55S

21-301-MK



Electric Wiper Motor with switch & wiring-USA made-switch will accept original knob

21-301-55	2 speed	55-57	\$499.95
21-301-58	2 speed	58-59	\$499.95
21-0200	pulse wiper control 3 speed w/ washer—accepts 5-304-B bezel	47-72	\$199.95

Bushing kit w/ new electric wiper motor

21-0001	4 replacement nylon bushing w/ washers		\$7.95
---------	--	--	--------

Electric Wiper Motor 12V original used tested

21-301-55U	when available	55-57	
21-301-58U	when available	58-59	

Wiper Knob—fit OE wiper controls only

5-304	chrome w/ 9/32 hole & set screw	55-59	\$24.95
5-304-A	black w/pentagon hole & set screw /paint white for GMC	55-59	\$13.95

Wiper Switch-will not accept original knobs

5-304-B	accepts bezel 5-304-B		
21-0201-S	universal 2 speed switch w/o washers-accepts 36-309 radio knob for original look	47-58	\$19.95

Wiper Switch Retainer/Bezel

5-0304-B	fits OE & replacement switches	55-59	\$14.95
----------	--------------------------------	-------	---------

Wiper Motor Slider

21-302-55S	plastic control slider on electric motor	55-57	\$11.95
------------	--	-------	---------

Wiper Motor Mount kit

21-301-MK	well nut w/ screw, washer to secure bkts to cab w/ OE wiper motors as required-	each	55-59	\$3.95
-----------	---	------	-------	--------

Wiper Arm - Stainless Steel

21-0303-L	left	54-59	\$24.95
21-0303-R	right	54-59	\$24.95

Wiper Blade

21-303-B	stainless steel	each	55-59	\$23.95
----------	-----------------	------	-------	---------

Bill's Truck Shop

Phone (905) 725-3460 / (905) 725-2022

Wipers

Due to the fluctuation of the Canadian and American dollars call for current prices

Group 21

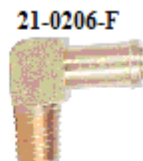
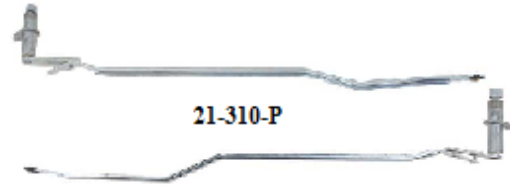

Wiper to Cowl Bezels

21-305-B chrome pair 55-59 \$39.95

Wiper to Cowl Bezel Gaskets

21-305-G installs under dash @ transmission pair 55-59 \$4.50

Washer Nozzles

21-305-WN pair 55-59 \$8.95

Wiper Bezel Nuts

21-0205-N pair 47-59 \$8.95

Wiper Transmission Arm Grommets

21-0309 for 58/59 w/ electric wipers pair 58-59 \$4.00

Wiper Transmission Arm Retainer & Spring

21-0209-1 54-59 \$4.95

Wiper Transmission Arm and Pivot

21-310-P pair 55-59 \$225.00

Vacuum Hose –vacuum wiper to engine outlet

21-0206-VH 3' 7/32 dia hose 47-59 \$3.25

Vac Outlet on Intake Manifold

21-0206-F brass 90 deg -----3/8 OD 47-59 \$8.95

21-0206-G brass 90 deg----- 13/16 OD

21-0206-H brass 90 deg -----13/16 OD---pr 47-59 \$14.50

Windshield Washer Pump

21-0211-U Electric (universal) \$44.95

Bill's Truck Shop

Phone (905) 725-3460 / (905) 725-2022

Heater

Due to the fluctuation of the Canadian and American dollars call for current prices

Group 22

Please pay close attention when ordering heater parts- there seams to be at least 4 different types/designs of heater in Chev & GMC trucks – we have added some pictures

Year

New



22-0202-CA



22-0302-A

22-302-D



22-302 -D dlx heater core-includes water valve support-
7 1/2 x 6 3/4 x 2 3/4 **NEW copper/brass CORE**

55-59

\$389.95

Heater Core Assembly w /12v motor

22-0302-A replacement assembly w/ 12 V motor –new square core w/ round tanks- must install support from old assembly

47-57

\$449.95

Heater Core Assembly (copper) w/ 11/16 pipe outlets

22-0202-CA round assembly- no motor

47-57

\$389.95

Bill's Truck Shop

Phone (905) 725-3460 / (905) 725-2022



22-310-L

Defroster Outlets

22-310-P	ABS plastic- fits L o R each	55-59	\$39.95
----------	------------------------------	-------	---------



22-0209

Defroster Duct Hose-OE cloth style

22-0209	2" x40"	54-63	\$54.95
22-0209-P	plastic 2 "	54-63	\$32.95



22-0058

22-0201

Heater Accessory Kit

22-0201 a compact 12 volt replacement-includes switch & cable operated defrost -does not include hose & vents 5/8 pipe outlets- will accept 1 3/4 or 2" defrost hose on defrost outlets grommet # 22-208 requires 22-0058 adaptors for firewall outlet

\$359.95



22-208

22-0058	90 deg 5/8 brass adaptors	pair	\$19.95
---------	---------------------------	------	---------

Heater Hose Grommets-in firewall

22-208	w/ Deluxe /Fresh Air Heater	47-55	\$8.95
--------	-----------------------------	-------	--------

Bill's Truck Shop

Phone (905) 725-3460 / (905) 725-2022

Heater

Due to the fluctuation of the Canadian and American dollars call for current prices

Group 22

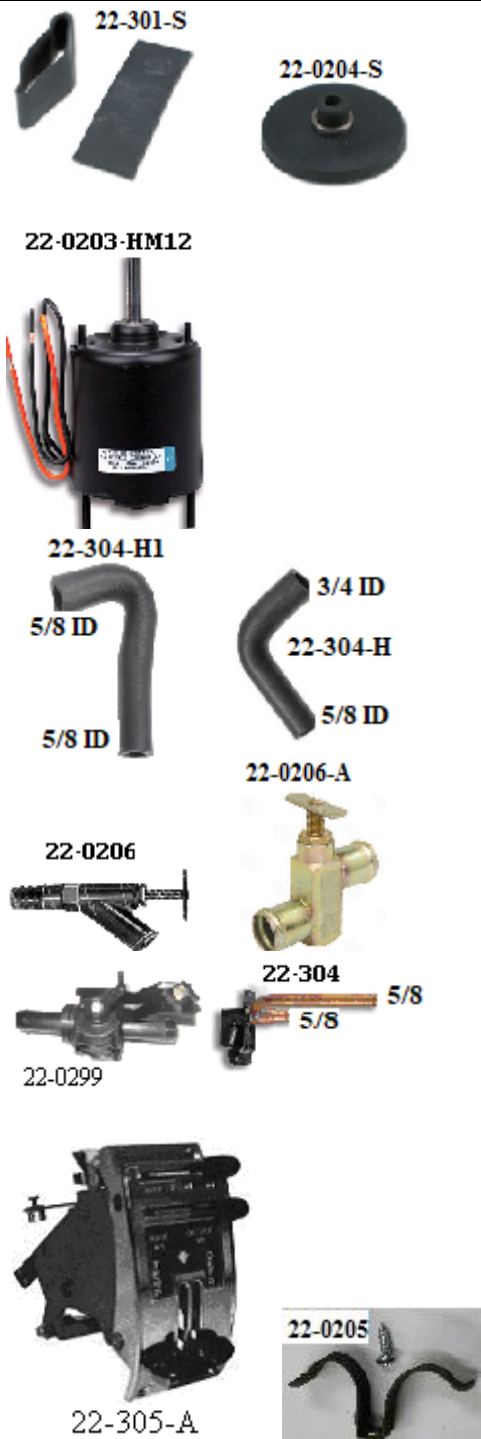

Please pay close attention when ordering heater parts- there seams to be at least 4 different types/designs of heater in Chev & GMC trucks – we have added some pictures

Deluxe Heater Bands -heater box to side panel housing

	Year	New
22-301-S w/ Deluxe/ Fresh air heaters	55-59	\$17.95

Heater Motor- may require drilling new stud mount holes

22-0759-12V 12 V motor for round style heater cores w / ¼ inch dia shaft-2 5/16 stud –3.75 body length- 2 way rotation	47-59	\$149.95
--	-------	----------

22-0203-HM12 12 V motor for rectangular heater w 5/16 shaft –mount bolt spacing 2 5/16---3 5/16 “ body length 2 wire for rev or forward rotation all w/ Deluxe/ Fresh air heaters	47-66	\$109.95
---	-------	----------

Dlx Heater Control Valve

22-304 55-56 w/ deluxe heater with 5/8 tube & will also work on 57 to 59	55-59	\$224.95
--	-------	----------

Dlx Heater Control Valve Hose-check heater core pipe size for water valve

22-304-H 5/8 & ¾ ID ends- curved hose @ valve	55-59	\$22.95
---	-------	---------

22-304-H1 5/8 & 5/8 ID ends curved hose	55.59	\$29.95
---	-------	---------

Water Control Valve

22-0299 heater hose-manual control water valve -pull to open 5/8 by 5/8 hose dia- can use 55-59 (T) throttle cable to operate	47-87	\$42.95
---	-------	---------

Heater Hose Water Shut-off Valve-manual

22-0206 5/8 hose to 3/8 pipe	37-62	\$49.95
------------------------------	-------	---------

22-0206-A 5/8 in 5/8 out	37-62	\$39.95
--------------------------	-------	---------

Heater Hose Retainer w/ screw

22-0205 original used- on pass inner fender	40-59	\$19.95
---	-------	---------

Heater Hose

Accel 18-0401 5/8 black-per foot		\$3.95
----------------------------------	--	--------

18-0402 3/4 black-per foot		\$4.25
----------------------------	--	--------

Heater Control Assembly/dlx -complete w/ levers & switch

22-305-A Chev	55-59	\$369.95
---------------	-------	----------

Bill's Truck Shop

Phone (905) 725-3460 / (905) 725-2022

Heater

Due to the fluctuation of the Canadian and American dollars call for current prices

Group 22



			<u>Year</u>	<u>New</u>	
Heater Control Bezel	chrome				
22-305-B	Chev		55-59	\$69.95	
Heater Backing Plate - for lens					
22-305-P	black -Chev only		55-59	\$5.95	
Heater Control Lens Face					
22-305-DL	Chev only		55-59	\$19.95	
Heater Switch					
22-305-S	rotary OE style w/ standard heater w/ black knob-accepts OE chrome knob---	2 speed	55-59	\$54.95	
22-305-D		deluxe heater	55-59	\$62.95	
22-205-12V	universal w/ lighted control	10 amp/ 12 volt	47-59	\$44.95	
Heater Switch Screws					
22-305-SS	screws to secure switch to housing w/ dlx heater	pr	55-59	\$2.00	
Heater Levers-----vertical levers only					
22-305-L	Chev	pair	55-59	\$38.95	
22-306-L	GMC	pair	55-59	\$59.95	
Heater Knobs					
22-305-K	w/ deluxe heater 4 pcs black	Chev-GMC	55-59	\$15.95	
22-305-KG	w / deluxe heater 4 pcs/ correct	white knobs found on GMC trucks	NEW ITEM!!	55-59	\$34.95
36-309	w/std heaters	-chrome w/ 3/16 hole & set screw	55-59	\$21.95	
Heater Cables					
		for deluxe heater			
22-305-C	Chev		55-59	\$56.95	
22-306-G	GMC		55-59	\$56.95	
Heater Cable Retainers					
4-0085-K		3 pc	47-87	\$0.95	
Heater Motor Wire Grommet					
22-302-G	@ front housing w/ recirculating heater		55-59	\$2.50	
Heater Wiring Harness, Deluxe					
22-312-H			55-59	\$49.95	
Heater Decal /Defroster Decal					
22-313	for standard recirculating heater		55-59	\$8.95	
Manual Defroster Lever Decal					
22-0212	fresh air & recirculating heater		47-59	\$7.95	

Bill's Truck Shop
Phone (905) 725-3460 / (905) 725-2022

4-0550-K



AC O-Ring kit

4-0550-K \$14.95

Hurricane Heat Cool & Defrost Unit, Deluxe Control, Wire Harness, Electric Bypass Heater valve, Expansion Valve, Duct Hose, Louvers, Plastic Glove Box, Mounting Brackets and Necessary Hardware.

Inquire

AC w/ heater kits-mounts in original heater location—due to the many engine options today call for information & pricing

-may require upgrade to electric fan & shroud to increase cooling output
 -Chev & GMC have diff dash design-picture shows Chev w/ dlx in dash control

Kits- can be purchased w/ or w/ comp & bkts
 Chev—w/ electronic or manual control in or under dash

---- engine size & comp location

GMC—w/ electronic under dash control



4-0054P

AC & Defrost hose

4-0051P	Plastic AC & defrost hose	6' x 2"	\$34.95
4-0053P	Plastic AC & defrost hose	6' x 2 1/2"	\$34.95
4-0054P	Plastic AC & defrost hose	6' x 3"	\$34.95
4-0055P	Plastic AC & defrost hose	6' x 3 1/2"	\$34.95
4-0056C	Cloth AC & defrost hose	6' x 3 1/4"	\$99.95

Bill's Truck Shop

Phone (905) 725-3460 / (905) 725-2022



Hood-Fender Emblem

Due to the fluctuation of the Canadian and American dollars call for current prices

Group 23

23-301-55



23-301-56V



23-301-57V

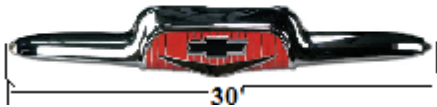

23-301-58



23-301-59V



23-302-55



23-302-56



23-302-57



23-302-57C



HOOD EMBLEM-Front

Chev

23-301-55 chrome w / black painted details & red bowtie 55-55 \$424.95

23-301-56V chrome w/ black details & red painted bowtie w / v eight note-outside mounting holes 22 1/2" apart 56-56 \$424.95

23-301-57V chrome w/ red painted details & black bowtie w / v eight note-outside mounting holes 22 1/2" apart 57-57 \$424.95

Fender Emblem

3100 for US & 1300 for Canada built trucks

23-302-55 3100 chrome w/ white details pair 55-55 \$489.95

23-302-56 3100 chrome w/ black details 4 pc set 56-56 \$439.95

23-302-57 3100 chrome w/ red details pair 57-57 \$379.95

23-302-57C 3124 chrome w/ red details/ Cameo pair 57-57 \$459.95

Bill's Truck Shop

Phone (905) 725-3460 / (905) 725-2022



Bed Side Emblems-FLEETSIDE

23-310-58 w/ hdw made in USA each 58-59 \$89.95

23-0727



Emblem Fasten 8 x 10-24x1 studs & 8 high dome nuts 16 pcs 47-59 \$14.95

23-0727

Hood Ornament – rockets

23-308-55



23-308-55 die cast/chrome bird 55-56 \$375.00

23-308-57



23-308-57 die-cast/chrome hood rockets pair 57-57 \$949.95

23-304-57



Hydramatic Emblem

23-304-57 on doors for automatic trucks pair 57-57 \$74.95

23-306-55



Fender / Door Emblem for V8

23-306-55 V8 on fender pair 55-56 \$79.95

23-306-57



23-306-57 on door pair 57-57 \$74.95

23-0344



Napco Emblem

23-0344 hood & fender each 51-59 \$114.95

23-0345



Napco Dash Plate-shift pattern

23-0345 metal plate on dash 54-59 \$39.95

Grills- Trim

Due to the fluctuation of the Canadian and American dollars call for current prices

Group 24

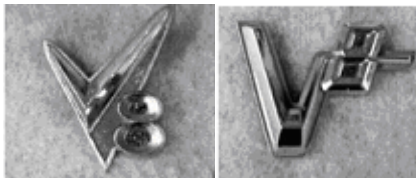
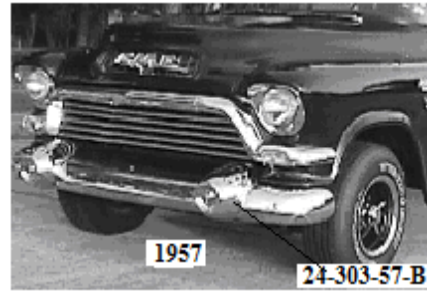

23-305-57G-V8 23-305-58G-V8



23-303-55 M



24-303-57-B

GMC Grill
GMC grill /eyebrows/ bullets/mls

Year New

Bumper Bullets

24-303-57-B bumper bullets have cone in end w/
no grille attachment chrome pair 57-57 \$289.95

HOOD Emblem- GMC

23-303-55 M GMC 55-early
stainless steel mesh behind hood emblem 56 \$259.95

FENDER Emblem

23-305-57G-V8 chrome/ GMC w/ V8 engine pair 55-57 \$179.90

Bill's Truck Shop

Phone (905) 725-3460 / (905) 725-2022

Grills- Trim

Due to the fluctuation of the Canadian and American dollars call for current prices

Group 24



CHEV	Grill		Year	New
24-301-55	chrome		55-56	\$799.95
24-301-55P	white painted	SPECIAL ORDER	55-56	\$859.95
24-301-57	chrome		57-57	\$1129.95
24-301-57P	white painted		57-57	\$849.95
24-301-58	chrome	w/black accent letters	58-59	\$849.95
Headlamp Bezels w/ screws				
16-355-B	chrome w/ seals	pair	55-57	\$229.95
16-358-B	chrome	pair	58-59	\$154.95
Grill Hardware Install kit				
24-301-55K	to install grille	12 pcs - Chev only	55-56	\$17.95
24-301-57K	to install grille	17 pcs- Chev only	57-57	\$15.95
24-301-58K	to install grille	8 pcs-Chev & GMC	58-59	\$12.95
Grille-supports to grille- outer & inner				
24-301-58SK	12 screws w/nuts		58-59	\$2.95
Headlight Bezel Screws= stainless steel				
16-355-S		6 pcs	55-57	\$2.50
16-358-S		8 pcs	58-59	\$2.95
Headlamp Bezel Seals w/ wire core as original				
16-0207-1		pair	47-57	\$23.95
Grill Decals				
24-302-58B		black	58-59	\$5.95
24-302-58W		white	58-59	\$5.95

Bill's Truck Shop
 Phone (905) 725-3460 / (905) 725-2022

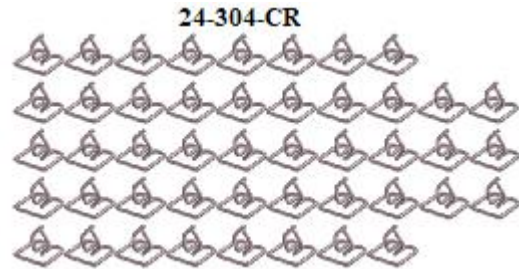
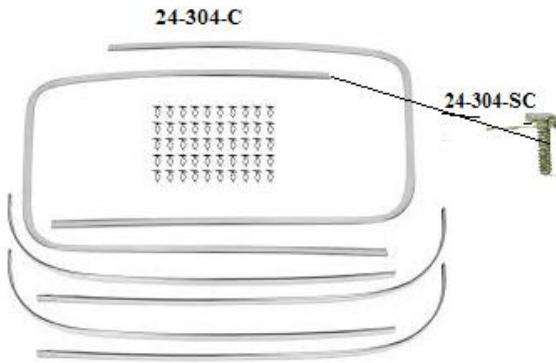

Cab Trim	<i>inquire on individual used pcs</i>		
24-304-C	stainless steel w/clips- deluxe cab	55-59	\$224.95
24-304-CR	clip kit for cab trim –fits OE trim holes only (NO water seal on clip) piece kit	50	55-59 \$22.95
24-304-C1	push in spring clip	each	55-59 \$0.50
24-304-SC	nut on clip & door end upper	each	55-59 \$5.95

24-3156

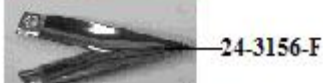
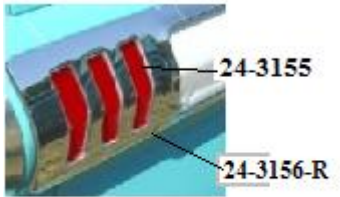

BTS exclusive

Bed Trim Decal

24-3155 bright red reflective decal behind underneath rear trim mld set 58-59 \$11.95

Bed Mld End Trim set-4pc

24-3156 end pcs for short/long bed truck w/ stainless mld-chrome die cast w/ red decals 58-59 \$459.95

24-3156-F front spear w/ hdw each 58-59 \$45.00

Hardware kit-bed mld end trim

24-3156-K washers, spacers, nuts & screws to install chrome end pcs 58-59 \$12.95

Mld Retainers as required

24-3000 (5/16--.3125 hole) push in clip each 58-59 \$3.70

24-3001 nut on clip w /hdw each 58-59 \$5.25



Bed Side Emblems-FLEETSIDE

23-310-58 w/ hdw made in USA each 58-59 \$89.95

Emblem Fastener kit

23-0727 8 x 10-24x1 studs & 8 high dome nuts 16 ;pcs 47-59 \$14.95



Bill's Truck Shop

Phone (905) 725-3460 / (905) 725-2022

Rims-Hubcaps-Trim Rings

Group 24



24-305-55



24-0305-57
24-0205-S



24-306-55

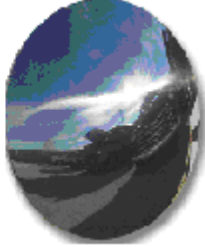

24-007-15S



24-007-15R



24-007-16R



24-0201-15

Hubcaps		Year	New
Chevy fits 15 and 16 clip style rims			
24-305-55	chrome w/ Bombay Ivory painted details-each	55-56	\$129.95
24-0305-57	chrome w/ black painted details each	57-60	\$129.95
GMC fits 15 and 16 clip style rims			
24-306-55G	chrome w/ red painted details -each	55-59	\$109.95
Smooth- Baby Moon style			
24-0205-S	stainless steel/smooth---w/ clip styles wheels only each		\$99.95
24-0205-8	chrome/smooth ---fit outside ear wheels only 10 1/8 OD chrome		\$36.95
Deluxe Wheel Beauty Ring			
24-307-TR	3' wide chrome ring w/ out black lines - used on 55-56 trucks but will fit 57-59 set of 4 - 15"	55-56	\$90.00
Beauty Ring (stainless steel)			
24-007-15S	15 inch w/ smooth face	each 47-87	\$44.95
24-007-15R	15-inch w/ ribbed face	each 47-87	\$48.95
24-007-16S	16 inch w/ smooth face	each 47-87	\$49.95
24-007-16R	16 inch w/ ribbed face	each 47-87	\$49.95
Moon Hub Caps—Salt Flat style			
24-0201-15	15 " wheels brushed stainless steel each		\$27.95

Bill's Truck Shop

Phone (905) 725-3460 / (905) 725-2022

Used



approx 1 15/16 tall
15 & 16" 8 stud clips

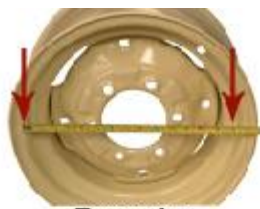

Diameter

Rim diameter is measured from tire bead seat area to tire bead seat area



Width

Rim width is measured from tire bead seat area to tire bead seat area

Wheel Clips each w/ hdw

Clips for retaining original type hubcaps. each

24-0905-15	for 15 & 16" 6 stud rims	37-62	\$4.50
24-0905-15K	for 15 & 16" 6 stud rim set 5 w/ hdw	37-62	\$19.95

Bill's Truck Shop

Phone (905) 725-3460 / (905) 725-2022

Bumpers-Brackets

Due to the fluctuation of the Canadian and American dollars call for current prices

Group 24



			<u>Year</u>	<u>New</u>
Bumpers –Premium Quality – triple nickel plated, and then chromed to a mirror finish -Ft bumpers require drilling for GMC trucks				
Front bumpers also fit rear panel or sub				
24-314-FC	front chrome and 55-59 panel/suburban rear	w/o plate bkt holes	55-59	\$379.95
24-314-FP	front painted		55-59	\$324.95
24-314-RC	rear chrome	stepside	55-59	\$359.95
24-314-RP	rear painted	stepside	55-59	\$379.95
24-314-RFC	rear chrome	fleetside	58-59	\$399.95
24-314-RFP	rear painted	fleetside	58-59	\$324.95
Bumper Bolts w/ hardware				
1-0BBC	chrome w/. High dome head	each	47-72	\$7.95
1-0BBS	stainless steel capped	each	47-72	\$5.95
1-0BBP	BLACK NEW ITEM	each	47-72	\$7.95
Bumper Bracket Kit Front w/ hardware				
24-316-F55	inner & outer		55-57	\$159.95
24-316-F58	inner & outer		58-59	\$159.95
Bumper Bracket Kit Rear w/ hardware				
24-316-RS	inner & outer	stepside	55-59	\$159.95
24-316-RF	inner & outer	fleetside	58-59	\$229.95
24-316-SP	suburb/panel rear outer	pair	55-59	\$159.95
License Plate Bracket & Lamp Assembly				
18-303-S	stepside		54-59	\$59.95
18-0303-F	fleetside-mounts to bumper		58-66	\$69.95
18-0812	plate bracket Bolt kit		58-66	\$9.95
18-0303-L	plate light lens		58-66	\$9.95
18-0303-G	plate light lens gasket		58-66	\$2.00

Bill's Truck Shop

Phone (905) 725-3460 / (905) 725-2022

Filler Panels-Grille Bars-Plate Bracket**Group 25**

25-301-55	(w/ grille supports)	Chev	55-56	\$179.95
25-301-57	(w/o grille supports)	Chev	55-57	\$169.95
25-301-58		Chev & GMC	58-59	\$149.95

Upper Grill Bar

25-302-55		Chev	55-56	\$119.95
25-302-57	recessed at grille mount holes	Chev	57-57	\$119.95

Front License Bracket

25-303-55	mounts on right side lower valance			
Chev - black			55-57	\$19.95
25-303-58	black	Chev & GMC	58-59	\$26.95

Bill's Truck Shop**Phone (905) 725-3460 / (905) 725-2022**

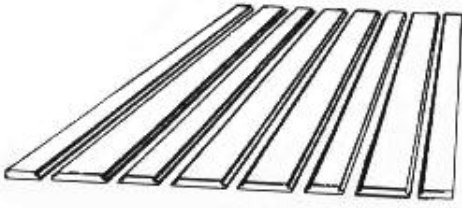

Wood-Cut to size with edges grooved, sanded and ready to finish, ----not drilled for mounting holes-3/4 kilned dried boards

red oak

		<u>Year</u>	<u>New</u>
26-0238	short step	54-59	\$624.95
26-0252	long step 89"	54-57	\$759.95
26-3254	long step 97"	57-59	\$799.95
26-0433	long step - 1 ton 107 1/4 "	54-59	Inquire
26-3260	short fleetside	58-59	\$874.95
26-3264	long fleetside	58-59	\$949.95

Yellow Pine

26-0239	short step	54-59	Inquire
26-3173	short step w/ predrilled mounting holes	55-59	Inquire
26-0253	long step 89"	54-57	Inquire
26-3255	long step 97"	57-59	Inquire
26-0359	long step-1 ton 107 1/4"	54-59	Inquire
26-3261	short fleet	58-59	Inquire
26-3265	long fleet	58-59	Inquire

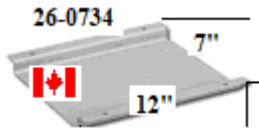

Heat Shield -to shield exhaust (tailpipe) on wood floor over rear axle-prevents wood from burning

26-0734	includes hdw	each	47-72	\$33.95
---------	--------------	------	-------	---------

Bed Strips

Due to the fluctuation of the Canadian and American dollars call for current prices

Group 26



Custom Bed Strips w/ hidden fasteners



Bed Strips – each strip is 1 ½” wide & made of 18 gage material. Stainless steel strips are #430 bright stainless and polished to a beautiful finish. Pre-punched w/ square holes for correct application. Can also order special lengths & hole location- **BS**=bed strips 7 strips required

Steel

		<u>Year</u>	<u>New</u>
26-0018	short step	54-59	\$179.95
26-0018-A	short step-each	54-59	
26-3048	long step 89"	55-57	\$179.95
26-3051	long step 97"	57-59	\$199.95
26-0684	1 ton long step 107" 7 pcs	54-59	\$199.95
26-3084	long fleetside	58-59	\$189.95
26-3072	short fleetside	58-59	\$179.95

Polished Stainless Steel

26-0016	short step	54-59	\$339.95
26-0016-A	short step- each strip	54-59	\$49.95
26-0434	1 ton long step 107 " 7pcs	54-59	\$369.95
26-3046	long stepside 89"	55-57	\$319.95
26-3049	long stepside 97"	57-59	\$359.95
26-3082	long fleetside	58-59	\$469.95
26-3070	short fleetside	58-59	\$399.95

Custom “WOW” Bed Strips w/ hidden fasteners

Polished Stainless Steel: custom strips w/ "T" type bolt slides on bottom of strip

26-0095	“T “ bolts w /hdw as required –short bed requires 7	each	\$6.00
26-0083	97 “ long - cut to fit	each	\$109.95

Bed Strip Kit

7 strips 82 “ w/ 49 “T” bolts and angle side hdw			
26-0083-K			\$899.95

Bill's Truck Shop

Phone (905) 725-3460 / (905) 725-2022



Angle Strips

Angle strips are pre-punched with 5/16 holes & can be spot welded or bolted to the sides (pair)

Steel

		<u>Year</u>	<u>New</u>	<u>Used</u>
27-0114	short stepside	54-59	\$84.95	
27-3138	long stepside 89"	55-57	\$94.95	
27-3147	long stepside 97"	57-59	\$94.95	
27-0140	long stepside 1 ton	54-59	\$119.95	

Polished Stainless Steel

27-0112	short stepside	54-59	\$144.95	
27-3136	long stepside 89"	55-57	\$146.75	
27-3145	long stepside 97"	57-59	\$169.75	
27-0437	long stepside 1 ton	54-59	Inquire	

Bill's Truck Shop

Phone (905) 725-3460 / (905) 725-2022

Bed Bolt Kits

Due to the fluctuation of the Canadian and American dollars call for current prices

Group 28

Year New

Kits include all bolts, nuts, washers to secure angles & strips plus to mount bed to frame

Zinc-bolt kit

28-3359	short stepside	55-59	\$89.95
28-3523	long stepside 89"long	55-57	\$94.95
28-3290	long stepside 97" long	57-59	\$99.95
28-0358	1 ton long step 107" long	54-59	\$99.95



28-3314	long fleetside	58-59	\$109.95
28-3305	short fleetside	58-59	\$94.95

Polished Stainless Steel -bolt kit

28-3357	short stepside	55-59	\$219.95
28-3521	long stepside 89" long	55-57	\$219.95
28-3288	long stepside 97" long	57-59	\$219.95
28-0439	1 ton long step 107 "long	54-59	\$199.95
28-3769	cameo & suburban	55-58	\$289.95
28-3312	long fleetside	58-59	\$259.95
28-3303	short fleetside	58-59	\$209.95



bolts through bed sills only-dome bottom of boards- for the clean floor look



28-0211



Bed Strips & Angles only bolt kit

Use this kit when hiding bed to frame bolts under your boards

28-0346	short step	54-59	\$94.95
---------	------------	-------	---------

Washer

28-0211	off-set washer-stainless steel 1 1/2 OD w/ 7/16 square hole	34-72	\$7.95
---------	---	-------	--------

Bill's Truck Shop

Phone (905) 725-3460 / (905) 725-2022

Bed Parts

Due to the fluctuation of the Canadian and American dollars call for current prices

Group 28



28-0354-T



28-3119



28-3WT

shows assembled box

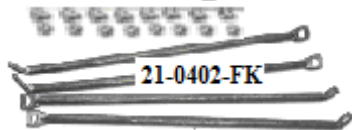

21-0402-FK

US parts not primed-Overseas parts black primer

Front Bed Panel

		<u>Year</u>	<u>New</u>	<u>Used</u>
Original style	made w/ 16 gauge steel			
28-0354-T	stepside made in Taiwan	54-59	\$189.95	
28-3119-T	fleetside-made in Taiwan	58-59	\$399.95	

Front Bed Panel Mounting Bolts

Steel

23-0387-S	Cap screw style steel---step & fleetside	54-72	\$12.95	
-----------	--	-------	---------	--

Stainless Steel

23-0387-SS	Phillips head stain-steel / step & fleet	54-72	\$19.95	
------------	--	-------	---------	--

Wheel Tubs

28-3WT	fleetside wheel tubs-each	58-59	\$249.95	
--------	---------------------------	-------	----------	--

Bed Sides

28-3063	short fleet- left	58-59	\$1599.95	
28-3064	short fleet-right	58-59	\$1599.95	

Braces-bed side to cross sill

21-0402-FK	set of 4 w/ hdw STEEL fleetside beds	58-66	\$74.95	
	Can be purchased EACH left or right side front or rear		\$20.00	
21-0402-FK-C	set of 4 w/ hdw CHROME fleetside beds	58-66	\$119.95	

Due to the fluctuation of the Canadian and American dollars call for current prices

Bill's Truck Shop

Phone (905) 725-3460 / (905) 725-2022

Tailgates

Due to the fluctuation of the Canadian and American dollars call for current prices

Group 29



21-0566-C
23-0SGMC-A



21-0566-G



23-0SBLANK



23-0682



30-0601-FI

STEPSIDE / FLEETSIDE

Year New

Chev

23-0SCHEV-T stepside/Chevrolet-Taiwan made 54-87 \$495.95

21-0566-C fleetside / Chev 58-66 \$845.95

GMC

23-0SGMC stepside 54-87 \$495.95

23-0SGMC-A stepside with original GMC script 55-62

21-0566-G fleetside w / GMC 58-66 \$845.95

BLANK

23-0SBLANK stepside 54-87 \$279.95

21-0566-B fleetside w/ out letters 58-66 \$595.95

Tailgate Covers

complete cover that can be welded over tailgate

Blank

23-0758 stepside-US made 54-87 \$158.95

Bowtie Embossed

23-0682 stepside 54-87 \$241.95

Tailgate emblem fleetside or stepside-
87-88 Tailgate Emblem - **FUEL INJECTION**, adhesive back

30-0601-FI \$49.95

Due to the fluctuation of the Canadian and American dollars call for current prices

Bill's Truck Shop

Phone (905) 725-3460 / (905) 725-2022

Tailgates Parts

Due to the fluctuation of the Canadian and American dollars call for current prices

Group 29

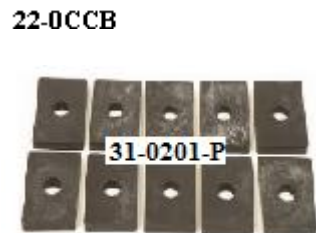
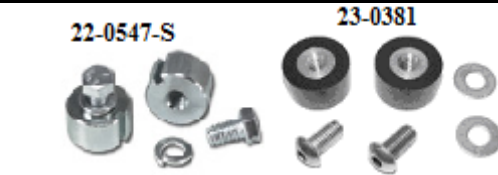

Tailgate Chain Arm Pivot Bolt w/Lock Nut-used to adjust arm tension

		<u>Year</u>	<u>New</u>
21-0308-Z	zinc-each	58-66	\$17.95
21-0308-S	stainless steel-each	58-66	\$26.95

Tailgate -support/pivot bolt in bed side **NEW**

21-0308-BS	fits L & R	each	58-66	\$24.95
------------	------------	------	-------	---------

Tailgate Trunions / Hinge

22-0547-S	cadmium plated w/ bolts /stepside	pair	54-87	\$29.95
23-0381	urethane w/ ss bolts / stepside	pair	54-87	\$54.95
22-0566	fleetside /cadmium plated	pair	58-66	\$38.95
21-0510-HK	Bolt kit-fleet side tailgate hinge-4pcs		58-72	\$14.95

Tailgate Chains w/ chain, hooks & eye bolt (pair)

21-0401-S	stainless steel - fleetside		58-66	\$109.95
22-0FZ	zinc / fleetside		58-66	\$59.95
23-0SS	stainless steel /stepside		54-87	\$99.95
23-0SZ	zinc / stepside		54-87	\$49.95

Tailgate Chain Covers (pair)

22-0CCB	black/ stepside		47-87	\$12.95
22-0CCC	clear / stepside		47-87	\$12.95
22-0CFB	black/fleetside w/ arm pads		58-66	\$16.95

Bed Pad Set - rubber pads

31-0201-P	10 pcs		54-72	\$14.95
-----------	--------	--	-------	---------

Bill's Truck Shop

Phone (905) 725-3460 / (905) 725-2022

CHEVROLET

CHEVROLET

STEPSIDE

GMC

GMC

23-OGSB-55

CHEV ROLET **CHEV ROLET**

31-0649

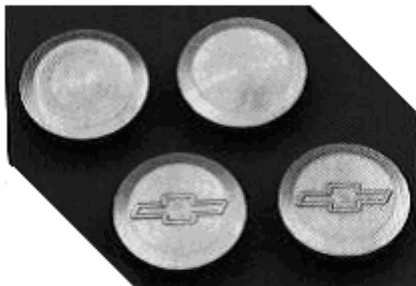

31-0752

Tailgate Letters

Stepside- Chev

23-0CSB	black / stepside	54-87	\$9.95
23-0CSW	white / stepside	54-87	\$9.95
23-0CSS	brushed stainless steel / stepside	54-87	\$9.95

Stepside- GMC

23-0GSB-55	black w/ OE style script	55-62	\$9.95
23-0GSW-55	white w/ OE style script	55-62	\$9.95
23-0GSS-55	brushed stainless w/OE style script	55-62	\$9.95
23-0GSB	black / stepside	54-87	\$9.95
23-0GSW	white / stepside	54-87	\$9.95
23-0GSS	brushed stainless steel/ stepside	54-87	\$9.95

Fleetside- Chev

21-0CFB	black / fleetside	58-66	\$9.95
21-0CFW	white / fleetside	58-66	\$9.95
21-0CFSS	brushed stainless steel/ fleetside	58-66	\$9.95

Fleetside- GMC

21-0GFB	black / fleetside	58-66	\$9.95
21-0GFW	white / fleetside	58-66	\$9.95
21-0GFSS	brushed stainless steel/ fleetside	58-66	\$9.95

Bed Hole Plugs Aluminium plug fits in hole at front and rear of *step side* bed rails. With rubber O-ring -- press in

Blank aluminium polished

31-0649	aluminum-polished-smooth	pair	47-66	\$79.95
31-0649-B	aluminum-brushed	pair	47-66	\$47.95

Bill's Truck Shop

Phone (905) 725-3460 / (905) 725-2022 / Fax (905) 404-2302 email: bill@billstruckshop.com



STEPSIDE TAILGATE EDGE PROTECTOR

Screw & or urethane to gate

22-0STP	brushed stainless steel	54-87	\$79.95
22-0STP-B	satin black stainless steel	54-87	\$79.95

Step side Stealth Tailgate Latches (pair)

Slotted stainless barrel w/spring loaded lock pin that is installed into the top gate roll & inserts in gate post

22-0SLK-S	stainless steel	pair	41-87	\$159.95
-----------	-----------------	------	-------	----------

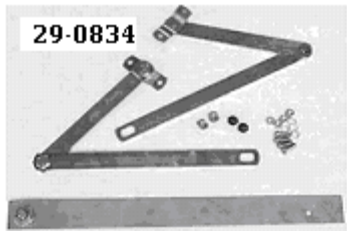

Bed Parts

Due to the fluctuation of the Canadian and American dollars call for current prices

Group 30

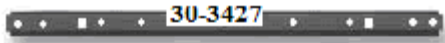

30-3427



recessed 30-3483



30-3715-T

21-0722-HK



30-0826-T



30-0204-T

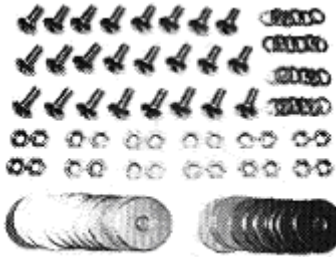

31-0202-SS

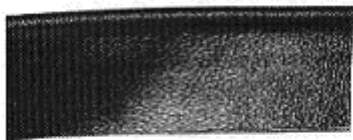

31-0WFB

		Year	New
Bed Cross Sill	pre-drilled w/ support plates		
30-3427	galvanized stepside	55-59	\$69.95
30-3483	#3-recessed @ rear shackle /short stepside	55-59	\$79.95
<i>ends are stamped w/ recess for spring shackle</i>			
30-3433	Cross sill -each fleetside	58-59	\$62.95
Short fleet has 3 cross sills & 1x 50 "rein			
/ long fleet has 5 cross sills& 2 x 50 " reinforcement			
Reinforcement Strip predrilled			
30-0437	50 "- 58/59 fleetside between wheel tubs and 54/59 long step	54-59	\$44.95
23-0706	w/ out holes stepside	54-87	\$25.00
Rear Cross Sill predrilled w/ support brackets			
30-3715-T	stepside	55-59	\$199.95
30-3720	fleetside	58-59	\$299.95
21-0722-HK	Rear cross sill hdw kit	54-87	\$13.95

ROLL PANS

Rear Roll Pan (steel) weld or bolts to rear cross sill
And bed sides with **NO** tag lights holes

With License Box

30-0826-T smooth w/licence box/made in Taiwan 54-87 \$239.95

24-0483 smooth - **long stepside** 54-87 \$279.95

Without License Box

24-0817 smooth / stepside 54-87 \$249.95

24-0839 smooth 4 row louvered / stepside 54-87 \$239.95

Rear Roll Pan Tag Light

30-0204-T top mount w/ chrome bezel \$12.95

Rear Step Fender Bolt Kit w/ bolts, washers& nuts

31-0202-SS stainless steel with clutch type head 47-66 \$69.95

31-0202-SS-P stainless steel w/philips head screw 47-66 \$69.95

25-06025 zinc w/ Phillips head 47-72 \$26.95

Rear Step Fender Welt Beading

31-0FWB black vinyl 25' 47-72 \$29.95

Bill's Truck Shop

Phone (905) 725-3460 / (905) 725-2022

Box Parts

Due to the fluctuation of the Canadian and American dollars call for current prices

Group 31



31-0649



31-0752

31-0405

23-0414



23-0191



22-0LFP

Bed sides are made from 16 gauge electro-galvanized steel and come with angels installed, stake pockets, fender holes, USA are not primed. Bed sides can be ordered with many different options: e.g., no pocket holes SS angels, no fender holes. . Inquire if necessary .Items w/ T are off shore produced parts

			<u>Year</u>	<u>New</u>
31-3639-T	short stepside-made in Taiwan	left	55-59	\$779.95
31-3640-T	short stepside-made in Taiwan	right	55-59	\$779.95

Stake Pocket - vertical post at front & rear of bed

31-0408	front	left	54-72	\$99.95
31-0405	front	right	54-72	\$99.95

22-0FLP	Flip down rear plate bkt			\$39.95
---------	--------------------------	--	--	---------

Due to the fluctuation of the Canadian and American dollars call for current prices

Bill's Truck Shop

Phone (905) 725-3460 / (905) 725-2022

Runningboards

Due to the fluctuation of the Canadian and American dollars call for current prices

Group 32



25-0410-L



25-0411-L

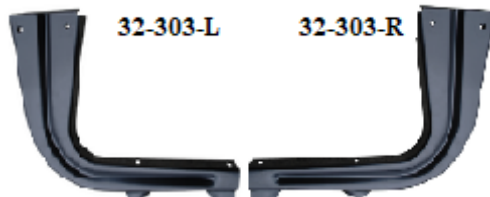

32-303-L

32-303-R



32-004



32-005



25-0510-BK

Running Board

			<u>Year</u>	<u>New</u>
25-0410-L	short step /	left	55-66	\$279.95
25-0410-R	short step /	right	55-66	\$279.95
25-0410-LC	short step CHROME-	left	55-66	\$399.95
25-0410-RC	short step CHROME-	right	55-66	\$399.95
8 ft long step				
25-0411-L-	long step/step vertical is 24 1/2 long	left	55-66	\$244.95
25-0411-R-	long step/step vertical is 24 1/2 long	right	55-66	\$244.95

Running board Support

32-303-L	left	55-59	\$56.95
32-303-R	right	55-59	\$56.95

Running board Step Plates pair w/ hardware

Polished aluminium-diamond top w/blue Bowtie				
32-004	5 1/4 x 14	pair	47-72	\$114.95
32-005	non pol alum w /older GMC design 5x10 5/8-pr		47-72	\$89.95

Running board Bolt Kit

25-0510-BK	-at support, sides & fender-Zinc	55-72	\$36.95
25-0510-BKS	chrome bolts w/ hdw-4 bolts	55-72	\$32.95

Due to the fluctuation of the Canadian and American dollars call for current prices

Bill's Truck Shop

Phone (905) 725-3460 / (905) 725-2022

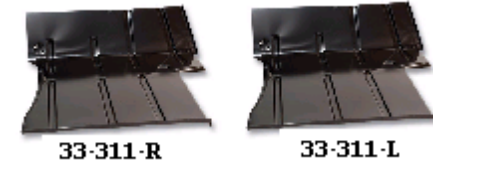
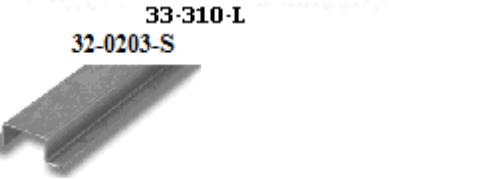
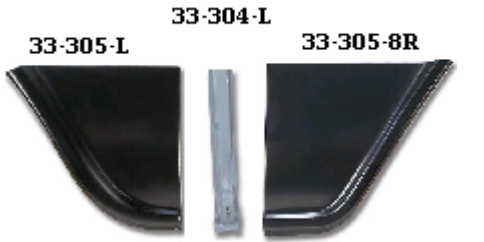

Front Fender Brace

33-304-L	15 "high	left	55-59	\$69.95
33-304-R	15 " high	right	55-59	\$69.95

Front Fender Lower rear

33-305-L	16" high	left	55-57	\$89.95
33-305-R	16" high	right	55-57	\$89.95
33-305-8L	16" high	left	58-59	\$89.95
33-305-8R	16" high	right	58-59	\$89.95

Door Outer Skin

33-306-L	8" high	left	55-59	\$99.95
33-306-R	8" high	right	55-59	\$99.95

Door Inner w/ Bottom

33-307-L1	9 " high	left	55-59	\$174.95
33-307-R1	9 " high	right	55-59	\$174.95

Door Post w/ Hinge Pocket "A" pillar

33-308-LF	15" high	left	55-59	\$69.95
33-308-RF	15" high	right	55-59	\$69.95

Door Pillar-Rear "B" Lower @ rocker step

33-308-LR	11 3/16 H	left	55-59	\$69.95
33-308-RR	11 3/16 H	right	55-59	\$69.95

Rocker/ Step w/support brace

33-309-L		left	55-59	\$169.95
33-309-R		right	55-59	\$169.98
2 nd design w/ more defined step lines (like OE) ,rocker support bkt , step support and recessed lip at top to join floor				
33-309-L-A			55-59	\$149.95
33-309-R-A			55-59	\$149.95

Rocker/ Step Support Brace

32-0203-S	30 "brace that is welded to bottom on cab step-each		55-59	\$24.95
-----------	---	--	-------	---------

Rocker Step Plate Support

33-309-S	left or right	each	55-59	\$45.95
----------	---------------	------	-------	---------

Rocker Panel Edge

33-310-L		left	55-59	\$79.95
33-310-R		right	55-59	\$79.95

Cab Floor Pans w/toe board

33-311-L	28" L X 24" wide	left	55-59	\$159.95
33-311-R	28" L X 24" wide	right	55-59	\$159.95

Bill's Truck Shop

Phone (905) 725-3460 / (905) 725-2022



			<u>Year</u>	<u>New</u>
Front Cab Support				
33-314-L		left	55-59	\$94.95
33-314-R		right	55-59	\$84.95
Rock Deflectors @ rear cab corner on stepside trucks				
33-312		pair	55-59	\$22.95
Cab Corner-outer w /door opening				
33-315-L	15' high	left	55-59	\$79.95
33-315-R	15"high	right	55-59	\$79.95
Cab Corner- inner				
33-316-L		left	55-59	\$99.95
33-316-R			55-59	\$99.95
Cab Corner Closure Panel <i>NEW ITEM</i>				
33-316-CP	fits left or right side inner floor @ cab corner- comes w/ bend tabs for easy welding to cab-can also be used when NOT installing inner cab corners		each	55-59 \$12.95
Inner Kick Panel Cover with screws				
33-317-L		left	55-59	\$69.95
33-317-R		right	55-59	\$69.95
33-317-SK	screw kit	12 pcs	55-59	\$2.50
Outer Pillar Pocket				
33-321-L		left	55-59	\$99.95
33-321-R		right	55-59	\$99.95
Inner Pillar Pocket				
33-322-L		left	55-59	\$92.95
33-322-R		right	55-59	\$92.95
Fender Support Bracket @ lower hinge post				
33-324-L		left	55-59	\$44.95
33-324-R		right	55-59	\$44.95
Lower Door Hinge Bracket in door w/ fine thread nuts SEE group 12 page 30				
33-325-L		left	55-59	\$59.95
33-325-R		right	55-59	\$59.95

Bill's Truck Shop
 Phone (905) 725-3460 / (905) 725-2022



			<u>Year</u>	<u>New</u>
Doors				
34-3LD		left	55-59	\$874.95
34-3RD		right	55-59	\$874.95
Door Hinge Bolts				
New Doors require 3/8 coarse thread bolts on door hinge pockets to secure hinge set of 6 per doors---2 x3/8 -16 x1 1/2 w/ 1 1/8 floating washer & 4 x 3/8-16 x 1 w/ 1" floating washer				
34-3HB-K			55-59	\$10.00
Fenders – Outer				
34-355-FL		left	55-56	\$789.95
34-355-FR		right	55-56	\$789.95
34-357-FL		left	57-57	\$789.95
34-357-FR		right	57-57	\$789.95
34-358-FL		left	58-59	\$789.95
34-358-FR		right	58-59	\$789.95
Front Sheet Metal hdw kit				
34-355-HK	stainless flat washers & bolts-philips drive to secure fit fenders & hood latch panel	24 bolts w/ washers	55-59	\$39.95
Front Fender Braces -front				
3-31FSS	polished stainless steel	pair	55-59	\$119.95
3-31F	steel	pair	55-59	\$39.95
Fender Extension at fender & rad support				
34-355-LE		left	55-57	\$112.95
34-355-RE		right	55-57	\$112.95
Fenders - Inner				
34-355-IL	uses 56-57 light harn grommet - left		55-57	\$269.95
34-355-IR	uses 56-57 light harn grommet - right		55-57	\$269.95
34-358-IL		left	58-59	\$249.95
34-358-IR		right	58-59	\$249.95
Inner Fender Support @ firewall				
34-355-S	pair/plain steel w/ hdw		55-59	\$22.95
34-355-S-SS	pair/brushed stainless w/ hdw		55-59	\$29.95
Rad Support				
34-355-RS	has 4 louvers per side		55-57	\$349.95
34-358-RS	has 3 louvers per side		58-59	\$259.95
Park lamp Harness Grommet				
16-305-G	each side of rad support	pair	55-59	\$5.75
Grille Surround				
34-358-GS			58-59	\$449.95

Bill's Truck Shop

Phone (905) 725-3460 / (905) 725-2022

				<u>Year</u>	<u>New</u>
 <p>34-355-HC</p>	Hoods				
	34-355-HC	smooth	Chev	55-56	\$899.95
 <p>34-357-HC</p>	34-357-HC	w/ spears	Chev	57-57	\$999.95
	34-358-H GMC & Chev 58-59 \$1299.95				
 <p>34-312-55C</p>	Hood Latch Panel				
	34-312-55C		Chev	55-57	\$109.95
 <p>34-312-58C</p>	34-312-58C		Chev	58-59	\$109.95
	Stepside Rear Fenders				
 <p>25-0566-L</p>	25-0566-R		right	55-66	\$799.95
	25-0566-L	w/ out spare cut-out	left	55-66	\$799.95
 <p>25-0566-L 25-0566-LS</p>	Fender Braces-stepside				
	25-359-F	steel @ front step w/treaded end	each	55-59	\$39.95
 <p>25-0566-K</p>	25-0566-K	3 pc set per fender		55-66	\$26.95
	Transmission Floor Cover – see section 8				
 <p>25-359-F</p>	Cowl Screen				
	33-345	OE style		55-59	\$119.95
 <p>25-0566-K</p>	33-345-A	custom style w/ o grill		55-59	\$119.95
	33-345-C	OE style- chrome		55-59	\$194.95
 <p>33-345 33-345-A 33-345-C</p>					

Bill's Truck Shop

Phone (905) 725-3460 / (905) 725-2022

Sheet Metal

Due to the fluctuation of the Canadian and American dollars call for current prices

Group 34



34-360-I



34-360-O



34-361



34-359-OB



34-359-OS



34-359-IB-B



34-359-IS

Inner Firewall Cowl Panel

34-360-I

Year

New

55-59

\$449.95

Outer Firewall Cowl Panel

34-360-O

55-59

\$445.95

Firewall Panel

34-361 complete replacement panel w/ factory holes- Chev
Has 55-57 batter tary hole pattern

55-59

\$539.95

Cab Rear Panel Outer w/ small back window

34-359-OS

55-59

\$999.95

Cab Rear Panel Outer w/ big back window

34-359-OB

55-59

\$995.95

Cab Rear Panel Inner w/ big back window

34-359-IB

55-59

\$410.00

Cab Rear Panel Inner w/ small back window

34-359-IS

55-59

\$249.95

Cab Rear Panel Inner w/ B-pillar @ big back window

34-359-IB-B

55-59

\$899.95

Due to the fluctuation of the Canadian and American dollars call for current prices

Bill's Truck Shop

Phone (905) 725-3460 / (905) 725-2022

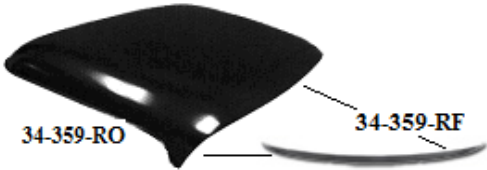

Roof-Outer Skin-includes roof to windshield opening panel

34-359-RO

Year New

55-59 \$729.95

Roof-Inner skin – includes side drip rails and fit inner w/ braces

34-359-RI a complete replacement panel-excellent for roof rot repair around front window

55-59 \$695.95

Roof-front/inner

34-359-FI replacement for front inner only-wraps around front 6" of roof-joins to 34-359-RF

55-59 \$189.95

Roof to window filler replacement panel

34-359-RF window pinch weld to outer roof skin

55-59 \$109.95

Support Brace- cab floor to rear wall inner support above @ cab support (do not come w/new floor)

33-330-BL w/weld in holes-drivers side each 55-59 \$29.95

33-330-BR w/weld in holes pass side each 55-59 \$29.95

33-330-BK pair 55-59 \$79.95

Cab Floor –up to front seam--does not include ft cab supports

33-314 L & R & rear cab braces 33-330-BK

33-330 complete floor w/ steps 55-59 \$1295.95

Bill's Truck Shop

Phone (905) 725-3460 / (905) 725-2022

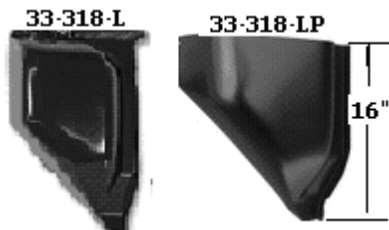

		<u>Year</u>	<u>New</u>
Cab "A" Pillar assembly w/ in & outer air box			
34-3360-L	left front pillar	55-59	\$609.95
34-3360-R	right front pillar	55-59	\$609.95
Cab "A" Pillar-full replacement-outer			
34-3361-L	left	55-59	\$224.95
34-3361-R	right	55-59	\$224.95
Cab Kick panel w/ air valve			
34-3362-L	left	55-59	\$271.95
34-3362-R	right	55-59	\$271.95
Cab "B" Pillar-full replacement			
34-3364-L		55-59	\$249.95
34-3364-R		55-59	\$245.95
Cage Nut—weld in support w/ nut & weld in holes - replaces the missing, rusty or stripped nut & support			
34-3363-CN	includes 1 fender bolt 1x 1/16 & 1/8 shim fits left & right	BTS exclusive	each 55-59 \$29.95
Outer Cowl Air Box-full replacement part			
33-318-L	left	55-59	\$114.95
33-318-R	right	55-59	\$114.95
Outer Cowl Air Box-partial repair item			
33-318-LP	left	55-59	\$99.95
33-318-RP	right	55-59	\$99.95

Bill's Truck Shop

Phone (905) 725-3460 / (905) 725-2022

34-3365-L

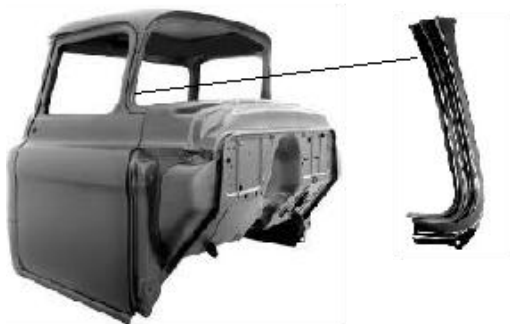

NEW PART

Pillar-Inner to outer window-replacement

34-3365-L

Year

New

55-59

\$64.95

34-3365-R

55-59

\$64.95

Bill's Truck Shop

Phone (905) 725-3460 / (905) 725-2022



Dash Panel

33-340-C	Chev	55-59	\$699.95
----------	------	-------	----------

Radio- Dash Repair Panel

33-357	w/ all factory holes	Chev only	55-59	\$69.95
33-357-S	smooth replacement panel 10 3/4W x 8 1/2 H			
Chev only			55-59	\$39.95

Bill's Truck Shop

Phone (905) 725-3460 / (905) 725-2022



Original Antenna With cable and hardware,
 36-305-T telescopic w/ hardware 55-59 \$139.95
If installing a new ant in the existing hole make sure it is in the correct location as it will only fit in the OE location -fender edge at rear
Side Mount Antenna-universal w/ cable and hardware -stainless steel
 36-0205-S dual stand side mount 36-59 \$49.95
 36-0205-S1 single stand side mount 36-59 \$49.95

Radio Face Plate Tuning Indicator
 36-307-C Chev 55-59 \$24.95
 36-0207-54G white screened GMC 54-59 \$23.95

Radio Knob chrome
 36-309 3 /16 hole with lock screw 55-59 \$21.95

Radio Spinner Knobs
 36-309-S plastic/chrome pair 55-59 \$15.95

Dual Voice Cone Speaker-fits original housing
 36-304-DVC 140 watts 55-59 \$89.95

Speaker Cover
 36-312-C chrome 55-59 \$99.95

Speaker Cover Screw kit 4 pcs
 36-312-SK 4 x 2 ½ screws 55-59 \$2.50

Bill's Truck Shop
 Phone (905) 725-3460 / (905) 725-2022



36-320-KP



5-0HAN



36-3USA-2



5-00RC

Kick panel Speaker set-Plastic panels w/moulded speaker (4 " 2 way 60 watt speakers)-pair

36-320-KP 55-59 \$239.95

36-320 w/o speaker/install you own 55-59 \$169.95

Radio-AM/FM – 55-59 CHEV **Radio-AM/FM** – new 12V ,electronic shafts, aux inputs for iPod,MP3,DVD,Satellite, seek & scan, digital clock,200 watts w/ chrome bezel & CHEV logo-fits original location w/o any modification-

36-3USA-2 55-59 \$319.95

Amplified Electronic AM/FM Hidden Antenna—requires 12 volt-includes 80” cable- peel- stick application

5-0HAN universal \$49.95

Radio-AM/FM – new 12V ,electronic shafts, aux inputs for iPod,MP3,DVD,Satellite, seek & scan, digital clock,200 watts w/ chrome bezel & CHEV logo-fits original location w/o any modification-**Chev USA 740 W/ BLUETOOTH**

36-3USA-7 55-59 \$549.95

Inquire about 55-59 GMC truck radios

Amplified Electronic AM/FM Hidden Antenna—requires 12 volt-includes 80” cable- peel- stick application

5-0HAN universal \$49.95

Condenser---Radio(noise) Suppression Condenser

5-00RC when using point ignition \$36.95

Bill's Truck Shop

Phone (905) 725-3460 / (905) 725-2022

37-0202-F



all 1/2 ton application & bonded unless noted

Year New

Brake Shoes (per axle)

37-0202-F	1/2 ton front shoes 2" set of 4	51-62	\$49.95
37-0202-R	1/2 ton rear shoes 11x 1 3/4 set of 4	51-58	\$69.95
37-0202-F	1/2 ton rear shoes 2" set of 4	51-62	\$69.95

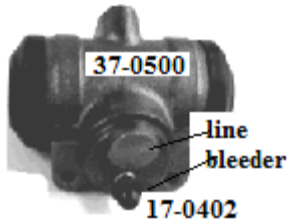

Wheel Cylinder (each)

37-0203-FL	1.125 bore front L 1/2ton	51-59	\$39.95
37-0204-FR	1.125 bore front R 1/2 ton	51-59	\$39.95
37-0303-RL	31/3200--- rear left 1/2 ton and 57-59 31—4x4	55-72	\$29.95
37-0303-RR	31/3200-----rear right 1/2 ton and 57-59 3100 4x4	55-72	\$29.95
37-0209	3600---- 3/4 & 1 front or rear L or R 1 1/4 bore	53-59	\$79.95
37-0009	3/4 & 1 front L or R w/ 1 1/8 bore	53-59	\$69.95
37-0499	rear cylinder or rear w/ dual cylinder 1 1/2- 2 ton Chev & GMC fit L or R	53-59	\$155.00
37-0500	front cylinder or rear w/ dual cylinder 1 1/2- 2 ton Chev & GMC fit L and R	53-59	\$155.00



37-0054

Wheel Cylinder Cups

37-0124	1 1/8 cup size	each	\$1.25
37-0138	1 3/8 cup size---	each	\$5.00
37-0125	1 1/4 cup size	each	\$3.95

Wheel Cylinder Rebuild kit

37-0054	1 1/4 " bore		\$29.95
17-0036	1 1/8 " bore		\$20.95
17-0046	1 "		\$11.95
37-0038	1 3/8 bore		\$36.95



37-0038



Wheel Cylinder Push Rod

37-0050		each	51-72	\$6.95
---------	--	------	-------	--------

Brake Shoe Guide Plate

37-0051	1/2 & 3/4 ton	each	51-87	\$9.95
---------	---------------	------	-------	--------

Bleeder Screw

17-0402	3/8 head 3/8 x 24	each	47-7	\$1.65
---------	-------------------	------	------	--------



37-0051

37-0050



Bill's Truck Shop

Phone (905) 725-3460 / (905) 725-2022

37-0245



37-0829



38-0250



37-0210-RS

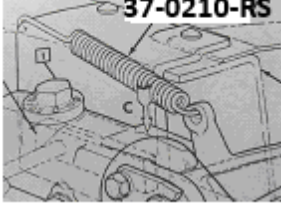

45-0134



Master Cylinder line adaptor

37-0829 5/16 inverted male w/ 1/4 female includes brass washer & 3/16 & 1/4 line fitting

\$7.95

Washer-master cylinder adaptor

37-0245 .800 OD-.500 IN

\$2.25

Brake Pedal Return Spring

37-0210-RS @ master cylinder

47-59

\$9.50

Backing Plate Plugs

38-0250

each

\$1.95

Hydraulic Brake Light Switch

45-0134 w/ adaptors & 3/16 line fittings & adaptors--closed circuit @ 45PSI

\$32.95

45-0134-S switch only

\$18.60

Bill's Truck Shop

Phone (905) 725-3460 / (905) 725-2022

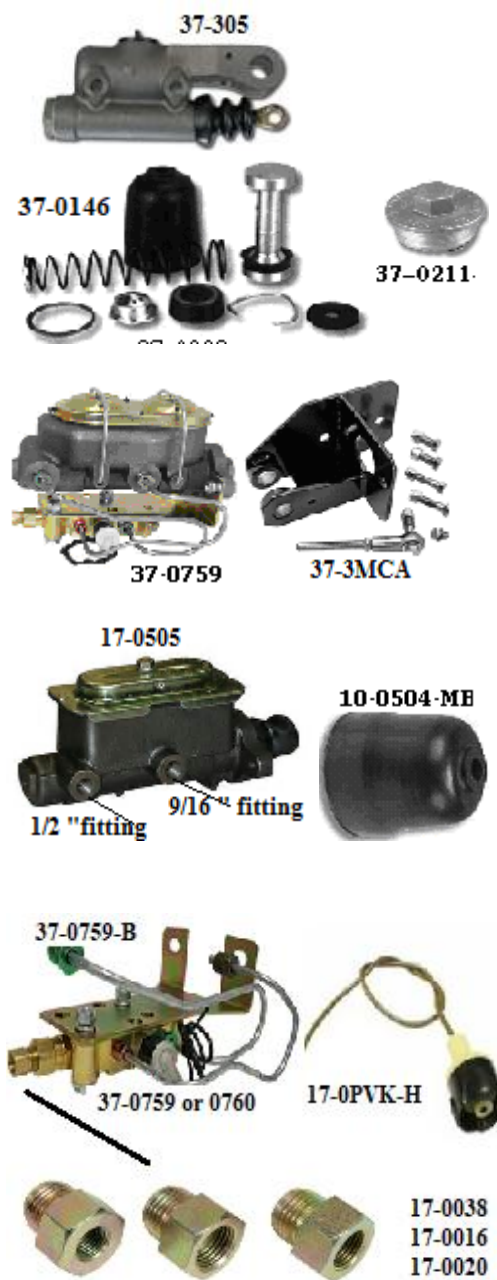

			<u>Year</u>	<u>New</u>
Master Cylinder complete new assembly				
37-305	1 1/8 cup	1/2 - 3/4 - 1 ton	55-59	\$169.95
Rebuild Kit Master Cylinder				
37-0146		1 1/8 bore	51-59	\$59.95
37-0033		1 1/4 bore -3/4 - 1 - 1 1/2 - 2 ton	36-59	\$49.95
Master Cylinder Fill Cap				
37-0211		1 1/4 OE metal w/gasket	40-59	\$34.95
37-0211-A		1 1/4-plastic w/ gasket	40-59	\$21.95
Master Cylinder Boot				
10-0504-MB		w/ manual brakes	47-72	\$7.95
Master Cylinder Bracket kit-				
37-3MCA		to convert to dual master w/ hdw	55-59	\$189.95
For manual brakes only see page 92 for power brake kits				
Master Cylinder-dual master for above kit-drum application only				
17-0505		NEW drum/drum master cylinder-1" bore		\$109.95
Master Cylinder w/ prop valve & bracket-when installing updated master under cab w/booster				
37-0759		disc- drum prop valve w/ lines & bracket	47-59	\$179.95
45-0DBK-5				
Bracket kit w/o master cylinder				
37-0759-B		includes disc-drum valve,lines,harness	47-59	\$169.95
Prop valve rear fitting				
17-0038		Fitting--9/16-18 inverted male to 3/8-24 female		\$6.99
17-0016		Fitting--9/16-18 inverted male to 7/16-24 female		\$6.99
17-0020		Fitting--9/16-18 inverted male to 1/2-20 female		\$6.95
Harness-proportioning valve switch				
17-0PVK-H		replacement harness w/ socket		\$12.95

Bill's Truck Shop

Phone (905) 725-3460 / (905) 725-2022

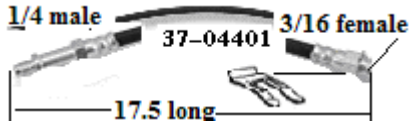
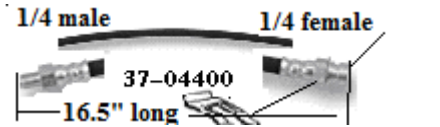

		<u>Year</u>	<u>New</u>
Brake Hose (each) see hose info for correct application when ordering			
37-04400	1/4 line w/Posi traction 1/2 ton rear-each	58-59	\$29.95
37-04400	1/4 line 3/4 ton rear-each	55-59	\$29.95
37-04401	3/16 line- 1/2 ton 3100 front-each	57-59	\$36.95
37-04401	3/16 line- 1/2 ton 3200 front-each	55-56	\$36.95
37-04402	3/16 line- 1/2 ton longbed front-each	57-59	\$29.95
37-04402	1/4 line 3/4 ton front-each	55-59	\$29.95
37-04402	1/4 line 1/2 ton 3100 rear-each	55-59	\$29.95
Hose ID- #04401 extended wheel cylinder end w/ "U" clip to secure on bkt ///04402 threaded end for nut (#37-0024) to secure through frame/// 04400 "U" clip to secure on support			
Brake Hose Nut			
37-0766	thread nut	each	\$1.25
Brake Hose Gasket			
37-0243	7/16 ID	each	\$3.25
37-0795	3/8 ID	each	\$1.25
Brake Hose Clips (each)			
37-0215-C			\$1.65
Brake Line Division Block			
37-0247	brake line "T" on R frame rail-secured w/ nut	51-57	\$38.95
Brake Fitting-oversize			
37-03025	(blue) 1/4 pipe-9/16 dia-18 threads per inch		\$3.50
37-03026	(gold) 1/4 pipe-1/2 dia-20 threads per inch		\$3.50
37-03023	(green) 3/16 pipe-1/2 dia-20 threads per inch		\$2.00
37-03024	(olive) 3/16 pipe 9/16-18 threads per inch		\$3.50
37-0471	"T" fitting 3/8-24 3/16 lines	each	\$10.95
Clamp-insulated			
37-0315	3/8 w/ hdw	pair	\$3.75
Rear Axle Division block			
37-0248	secures to diff housing bracket w/ clip to split (3/16) brake lines 1/2 ton NOT 53 & 54	51-66	\$29.95
37-0249	Rear axle block fitting 1/4 line	36-65	\$34.95
Division Block w/ mount bracket (universal)			
37-0476	3/16 tube 3/8-24 thread		\$29.95

Bill's Truck Shop

Phone (905) 725-3460 / (905) 725-2022

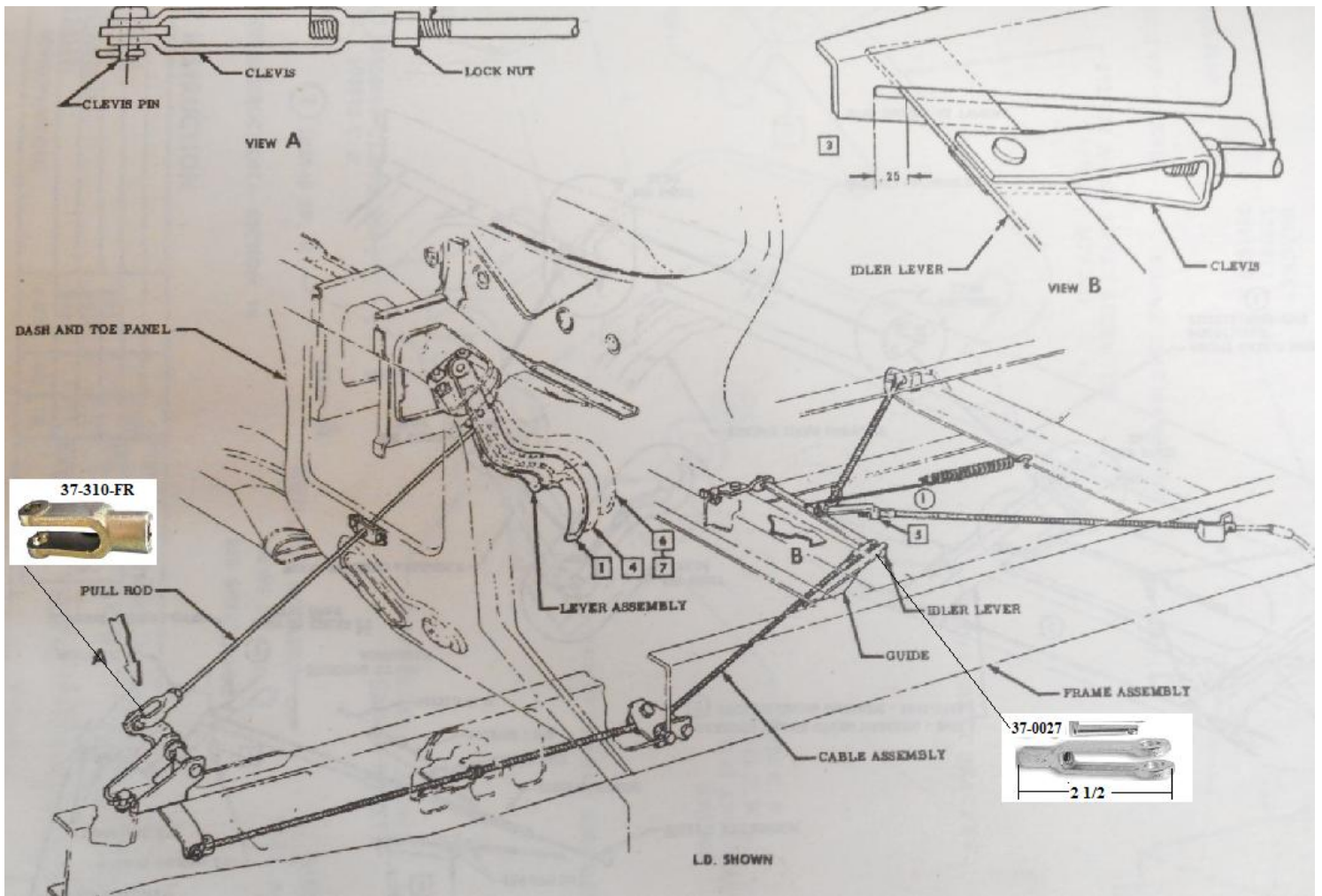

Brakes

Due to the fluctuation of the Canadian and American dollars call for current prices

Group 37

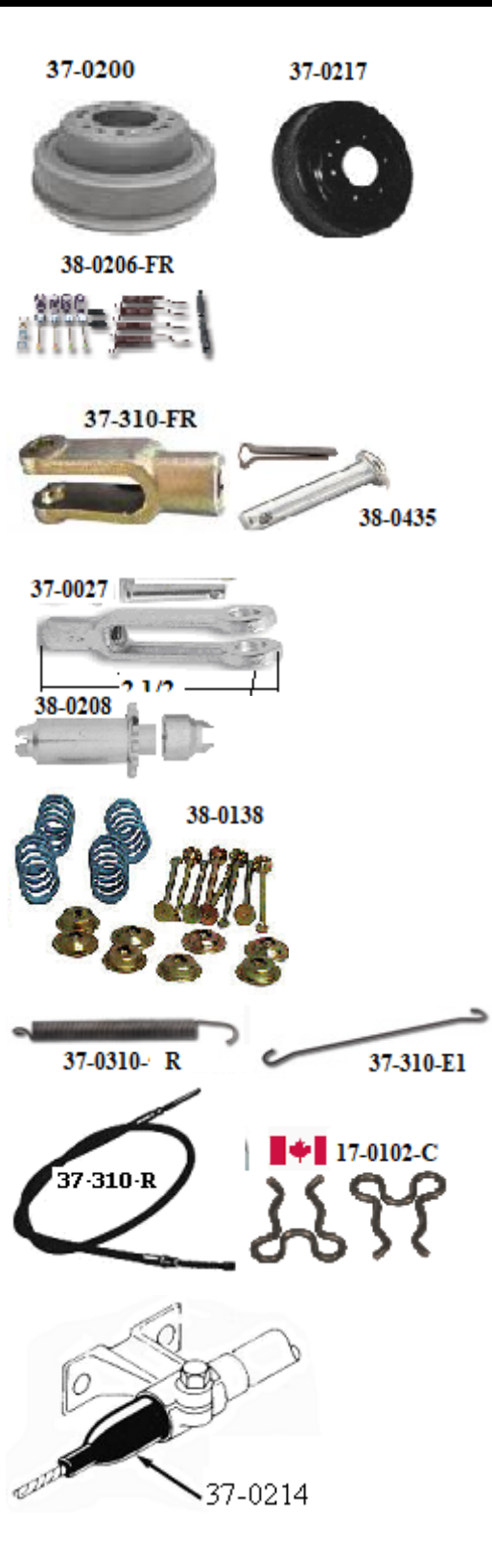

		<u>Year</u>	<u>New</u>
Brake Drum (each)			
37-0217	front or rear 1/2 ton 11"	each	51-70 \$79.95
37-0200	front brake drum 12 x 2 3/4 and 1 ton		53-62 \$169.95
Brake Spring Kit -hold down & return per axle			
38-0206-FR	front & rear axle 1/2 ton		51-63 \$18.95
Brake Shoe Hold Down kit			
38-0138	3/4 ton up -w/ 2 3/4 pin 12" shoes and up/ ft and rear per axle		51-87 \$14.95
Brake Adjuster Screw w/ out self adjusting brakes			
38-0208	L or R front & rear	each	51-62 \$16.95
Parking Brake Cable			
37-310-FS	front shortbed 3100		55-59 \$24.95
37-310-FL	front longbed 3200		55-59 \$26.95
37-310-R	rear cable 1/2 ton		55-59 \$44.95
37-310-R-B	w/Dana rear end-bolts to backing plate Total length approx. 64 / casing length approx. 32		55-59 \$69.95
Park Brake Return Spring			
37-0310-R	spring w/ rod-locates @ center frame support-		55-65 \$11.95
	55-59 1/2 ton, 58-59 4x4		
37-310-E1	6 ft short bed extension		55-59 \$5.25
Yoke-Parking Brake Rod Clevis			
37-0027	cable end at frame pivot 5/16 NF w/pin		55-59 \$19.95
37-310-FR	3/8-NF @ rod end at frame pivot		55-59 \$16.95
	----- @ at front of park rod & frame bkt		
Pin-cable yoke end			
38-0435	5 /16 x 1 1/4		47-55 \$1.45
Parking Brake Cable Reducer			
17-0500A	adjustable to reduce length of cable-	each	\$13.95
Parking Brake Cable Boot			
37-0214		each	47-59 \$4.25
Park Brake Cable Retainer			
17-0102-C	OE wire style	pair	55-87 \$5.95

Bill's Truck Shop
Phone (905) 725-3460 / (905) 725-2022

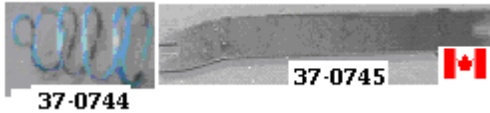

37-0744

37-0745



38-0208



38-0138

38-0206-FR



17-0701

17-0702

17-0444

17-0444-S

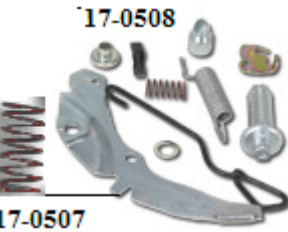

17-0508

17-0507

Brake Spring Kit -hold down & return per axle

38-0206-FR front & rear axle 1/2 ton 51-63 \$18.95

Brake Shoe Hold Down kit

38-0138 3/4 ton up -w/ 2 3/4 pin 12" shoes and up/ ft and rear per axle 51-87 \$14.95

Brake Adjuster Screw w/ out self adjusting brakes-has coarse tooth spacing

38-0208 L or R each 51-62 \$16.95

Park Brake Bar

37-0745 Strut-park brake 1/2-ton approx 7 1/2 long w/ 11 brakes 51-77 \$11.95

Park Brake Bar Spring

37-0744 @ cross bar & front shoe each 51-87 \$2.95

Fits 64-75 1/2-3/4 ton rear 2 and 4 wheel drive, 64 1/2 ton 2 wheel drive front, and 65-75 1/2 ton 2 and 4 wheel drive front.-can use to upgrade to self adjusting brakes from 51-63

17-0508 Brake Adjuster kit w/ 11 brakes L side 64-75 \$29.95

17-0509 Brake Adjuster kit w/ 11 brakes R side 64-75 \$29.95

17-0444 Park brake arm retainer clip w/ tension washer 2 pair /both sides 60-91 \$2.95

17-0444-S 2 Stud- park brake arm to shoe w/washer & clips 51-91 \$9.95

17-0444-S These park arms used the stud w/ C clip to secure to the shoe (not the bolt w/nut)

17-0701 Park brake cable arm-left 1/2 ton 51-91 \$34.95

17-0702 Park brake cable arm-right 1/2 ton 51-91 \$34.95

SELF ADJUSTING BRAKES-self adjusting brakes can be applied to any 1951-66 chev 1/2 brakes-add 17-0508 (right) and 17-0509 (left) for front 7 rear

Adjuster arm Spring

Sunvisor each \$1.50

Bill's Truck Shop

Phone (905) 725-3460 / (905) 725-2022

BRAKES



37-318-P



37-318-R



37-318-G

Parking Brake Roller

37-318-R nylon cable guide under cab 55-59 \$15.95

Parking Brake Roller Pin

37-318-P special collar bolt 55-59 \$10.95

Parking cable extension

37-0320 park cable at crossmember fits left & right w/ hdw each 55-59 \$21.95

Grommet-front park cable @ transmission crossmember

37-318-G 55-59 \$2.00

Spring-brake cable

37-310-RS located @ shackle to secure rear cables-each 55-59 \$8.95

Universal Park Cable Support

17-0001 11 gauge galvanized steel-can be used to anchor park cables on frame-bend support to each application-9/16 cable hole-may require enlarging/includes hdw-bend bkt to fit application \$18.95

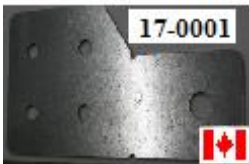
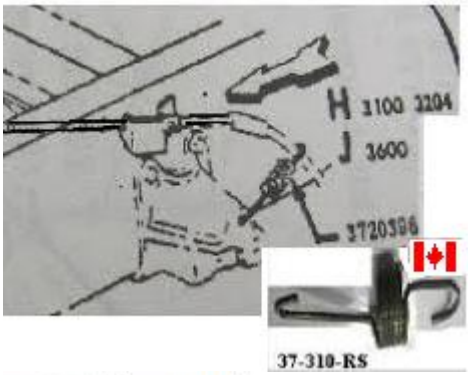
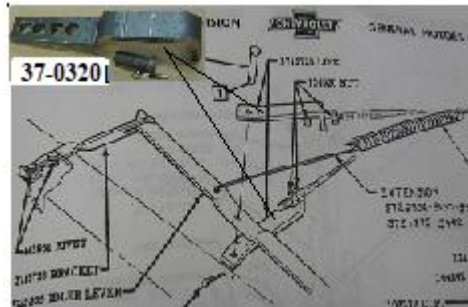

17-0001

37-310-RS

Bill's Truck Shop

Phone (905) 725-3460 / (905) 725-2022

Front Suspension Parts

Group 38



Year New

Wheel Bearings-front

38-0325 -I	inner wheel bearing- ball type-1/2 ton	38-59	\$79.95
38-0325-O	outer wheel bearing-ball type-1/ 2 ton	38-61	\$129.95
38-0325-3I	inner wheel bearing- ball type-3/4 & 1 ton	53-59	
38-0325-3O	outer wheel bearing-ball type 3/4 & 1 ton		\$88.50

Grease Seal-front

38-0326	1/ 2 ton 2 whl drive	each	38-59	\$24.95
38-0669	3/4, 1 and 1-1/2 ton	each	35-59	\$27.95

38-04759-BK

Wheel Bearings kit-upgrades to tapered roller bearings w/ grease seals	1/ 2 ton only		47-59	\$224.95
---	---------------	--	-------	----------

Wheel Stud s (each)

38-0230-S	7/16-20 X 1 3/8	each	51-70	\$3.95
-----------	-----------------	------	-------	--------

Wheel Nut

38-0230-N		each	36-70	\$4.25
-----------	--	------	-------	--------

Spindle Nut and Washer

15-0193			47-87	\$14.95
---------	--	--	-------	---------

Spindle Dust Cap

17-0977	approx 2 3/32 " OD	each	47-62	\$9.95
---------	--------------------	------	-------	--------

Backing Plate Plugs

38-0250		each		\$1.95
---------	--	------	--	--------

Bill's Truck Shop

Phone (905) 725-3460 / (905) 725-2022

Year New



Bracket-2 & 3 frame cross member support -each

38-345-S	fits L & R w/ hdw	each	55-59	\$34.95
----------	-------------------	------	-------	---------



. For rear leaf spring setups, these items help correct your rear end to **driveshaft angle** and eliminate vibration during operation at all speeds. Misalignment is common on lowered and lifted vehicles Our axle shims are also an important item when you have added power steering to your vintage straight axle front end. Original straight axle front ends came with minimal caster angle to make steering easier on the driver. When power steering is added, the **caster angle** must be increased or "road wander" becomes prevalent.



Pinon & Caster Angle Shim set

39-0004-FR	2 " wide 4 deg w/ bolt-ft caster or rear pinion angle 47-54 3/4 ton & 55-59 1/2-3/4 ton	47-59	\$54.95
39-3004	original caster shims 2" wide	pair	55-59



Main Leaf Spring-replace the main leaf only if bushing eyelets are broken or worn OR if leaf is broken- bushing not included



39-310M-R	rear	1/2 ton only	each	55-59	\$139.95
-----------	------	--------------	------	-------	----------

Leaf Spring Center Bolt w/nut ----- confirm size

39-0211-3/8	3/8 x 7 "	each	47-72	\$5.95
39-0211-5/16	5/16 x 7 "	each	47-72	\$5.95

Bill's Truck Shop

Phone (905) 725-3460 / (905) 725-2022

Steering & Suspension

Due to the fluctuation of the Canadian and American dollars call for current prices

Group 39

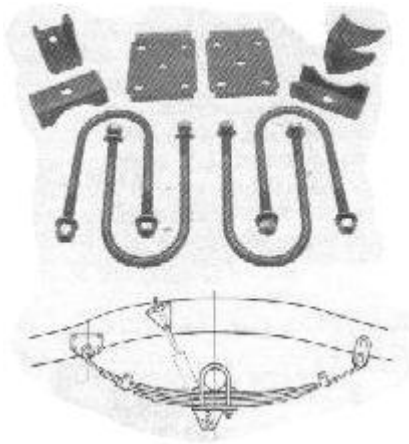

55-59 Rear axle conversion kit- use to update to later model 3" axle tube dia -- eg,F body rear ends

45-3RCK

Year

New

55-59

\$139.95

45-3559-RAS axle seat -- pr

55-59

\$19.95

Bill's Truck Shop

Phone (905) 725-3460 / (905) 725-2022



			<u>Year</u>	<u>New</u>
Shackle Kit -threaded pins, bushings, side plates & seals				
47-56	w/centre pin w/2" spring/57-59 w/ nut on bushing pin			
39-301-FR	47-55 1,1 ½,2 ton front & 55-56 ½. ¾ ton w/2 " spring front and rear		47-56	\$94.95
39-302-FR	-Ft or Rr-1/2 or ¾ w/ 2'spring		57-59	\$84.95
Spring Eye Bolt & Bushing at fixed end of spring				
39-304-F	front 1/2 -3/4 /threaded nut w/ 2" spring		55-59	\$45.95
39-304-R	rear 1/2- ¾ w/ notch lock w/ 2"spring		55-59	\$46.95
Lock Pin -threaded & tapered				
39-0205-P	secures rear spring eye bolt		55-59	\$24.95
Shackle Rubber Seals				
39-0206		each	47-59	\$1.50
King Pin Set				
39-308	std size .8660 x 5.312"	½ ton	55-59	\$159.95
39-308-1	std- size diameter .921	¾ & 1 ton	55-59	\$169.95
Grease/Zerk Fittings				
39-0227	1/4-28 Pipe Thread 45 degree-each			\$7.95
39-0225	1/4-28 Pipe Thread-straight----each			\$2.95
Shock Absorber Cylinder Type (gas) pre check rear shock mount length required -note # of leaf springs ft & rear				
39-314-55F	½ - ¾ ton front 12" closed/19" open			
55-56	Front 1/2, 3/4 & 1 ton	each	55-56	\$69.95
16-0008	½ - ¾ ton front 12" closed/19" open	each	57-59	\$69.95
39-314-57R	½ - ¾ rear 14"closed-23"open 1955-56 1/2 ton Longbed and 3/4 ton 1957-59 1/2 and 3/4 ton	each	55-59	\$89.95
Axle Bumper				
39-0218	47-55rear & 55-59 ft & rear	each	47-59	\$10.95
15-0560-BP	universal application axle/frame /control arm bumpers polyurethane 2" tall	pair		\$36.95
U-Bolts w/ hardware				
39-316-F	5" long front w/ 2 " spring	each	55-59	\$14.95
39-316-R	7 ½ long w/2" spring rear	each	55-59	\$12.95

Bill's Truck Shop

Phone (905) 725-3460 / (905) 725-2022

Steering & Suspension

Due to the fluctuation of the Canadian and American dollars call for current prices

Group 39



Shock Bolt—check OE hole size

		<u>Year</u>	<u>New</u>
15-0470	front lower	55-59	\$12.95
15-0590	up & lower rear and up front	55-59	\$11.95
15-0471	universal application		\$3.45

Shock Absorber Mount Brackets

39-315-RU	rear upper fits L or R	each	55-59	\$44.95
39-315-FU	front upper w fits L or R	each	55-59	\$47.95
MUST add 15-0590 shock bolt				
39-315-F	ft lower shock bkt-fits L or R	each	55-59	\$34.95

Bill's Truck Shop

Phone (905) 725-3460 / (905) 725-2022

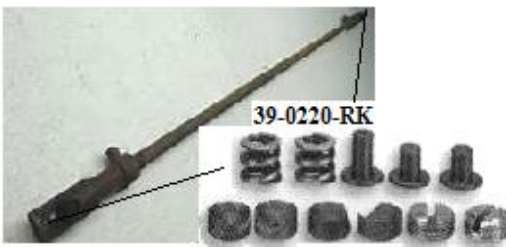
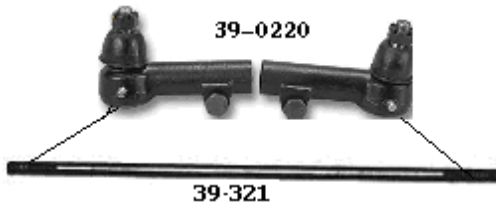

Tie Rod Ends

39-0220 replacement type w/ female threaded ends-1/2 and 3/4 ton w/ solid male style bar pair

Year	New
47-59	\$99.95

Tie Rod Ends ---- NEW style w/ hollow style female bar

39-0222-L	left tie rod end	34-59	\$69.95
39-0222-R	right tie rod end	34-59	\$69.95

Tie Rod Repair kit and 41-52 drag link

39-0220-RK	1/2 - 3/4 & 1 ton for both sides	29-59	\$44.95
------------	----------------------------------	-------	---------

Tie Rod Link -solid bar-threads must be cleaned before installing ends

39-321	threaded male bar between front wheels	55-59	\$89.95
--------	--	-------	---------

Tie Rod Ends ---- NEW style w/ hollow style w/ female bar 1/2 & 3/4-tapered shaft

39-0222-L	left tie rod end	34-59	\$69.95
39-0222-R	right tie rod end	34-59	\$69.95

Steering Drag Link pitman arm to steering arm

39-323	fits 1/2- 3/4- 1 ton	55-59	\$199.95
--------	----------------------	-------	----------

Power Steering Custom Drag Link

45-3559-DL	custom drag link for 400 series power steering box—adjustable (helps correct steering return on turns)	55-59	\$144.95
------------	--	-------	----------

Ball Stud @ steering arm for tie rod

39-0225-2	(1/2shoulder) at tie rod end 1/2 ton -each	34-59	\$49.95
39-0225-3	1/2 tapered shaft at tie rod end 3/4 ton - each	46-59	\$39.95

Tie Rod Boot

39-0176	w 9/16 shaft diameter	each	\$5.95
39-0177	w 5/8 shaft diameter	each	\$5.95

Bill's Truck Shop

Phone (905) 725-3460 / (905) 725-2022

Steering & Suspension

Due to the fluctuation of the Canadian and American dollars call for current prices

Group 39

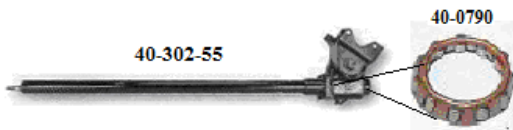

		<u>Year</u>	<u>New</u>
Steering Box –used sold as “AS IS “			
Rebuilt columns do not include new upper bearing- #18-0311-confirm if required—includes 5-0230-N Grease packed during assembly-no lube required-tube length- top of box casting to top of tube-OE ratio 24:1			
40-302-55	w / 3 speed column shift 36 1/2 “	55-56	Rebuilt \$395.00
40-302-57	w / 3 speed column shift 33 1/2 “	57-59	\$395.00
Pitman-Sector Bushing kit			
40-0056	2 brass bushing w/ seal	37-72	\$69.95
Pitman Shaft Nut w/ lock washer			
40-0055-N	w/ manual steering box	37-72	\$4.00
Upper Column Bearing -			
18-0311	with horn wire	47-59	\$94.95
Steering Box Thrust Bearing upper & lower			
40-0790		41-59	\$44.95
Steering Box Rebuild Kit w/ , bushings shims, gaskets & instructions does not include ball bearings			
40-301-1		55-59	\$179.95
Steering Box Bearing set			
40-0001	60 pcs 9/32 steel ball bearings		\$34.95
Steering Box Gasket set			
40-0808	end cap & cover	41-46 &55-59	\$9.95
Pitman Shaft Seal			
40-0055		37-72	\$21.95
Steering Stabilizer Kit--improves steering --NEW design--anchors at REAR u-bolt of leaf spring & drag link--improve steering ability, Kit includes stabilizer unit and mounting hdw--may require replacing 1 u-bolt (39-216-FR) if it cannot be removed			
40-0207		47-59	\$159.95

Bill's Truck Shop

Phone (905) 725-3460 / (905) 725-2022

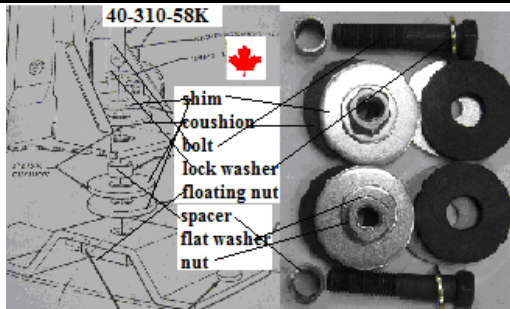

Radiator Support Mounting Pads

			<u>Year</u>	<u>New</u>
40-310	Chev	set of 4	55-59	\$6.95

Radiator Support Mount kit-includes bolts & cushions, washers

40-310-55K			55-57	\$29.95
40-310-58K	secures to square floating nut under stand-includes extra flat washer & lock nut if floating cage nut is missing or damaged		58-59	\$29.95



Cab Mount Kit With hardware

40-327		pickup	55-59	\$59.95
40-327-1		panel or suburban	55-59	\$79.95

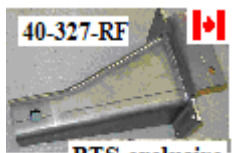

Cab Frame Support w/ hdw

40-327-LF		left front	55-59	\$149.95
40-327-RF		right front	55-59	\$149.95
40-327-R		left or right rear	each	55-59 \$69.95

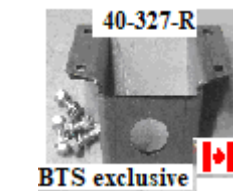

Front Motor Mounts

40-312-S	small cushion	each	55-59	\$3.40
40-312-L	large cushion	each	55-59	\$3.95
40-312-K	kit-8pcs		55-59	\$32.95
40-312-CHK	4 outer washer w/ nuts & external tooth lock washers	8 pcs per side	55-59	\$7.95
40-312-SV8	Engine mount stud w/V8	each	55-59	\$24.95
40-312-8	upper engine support V8	pair	55-59	\$44.95



V8 Conversion Kit

40-3V8	original style to install v-eight engine		55-59	\$259.95
40-3V8-HK	correct bolts/ washers to install		55-59	\$15.95



Bill's Truck Shop

Phone (905) 725-3460 / (905) 725-2022 /

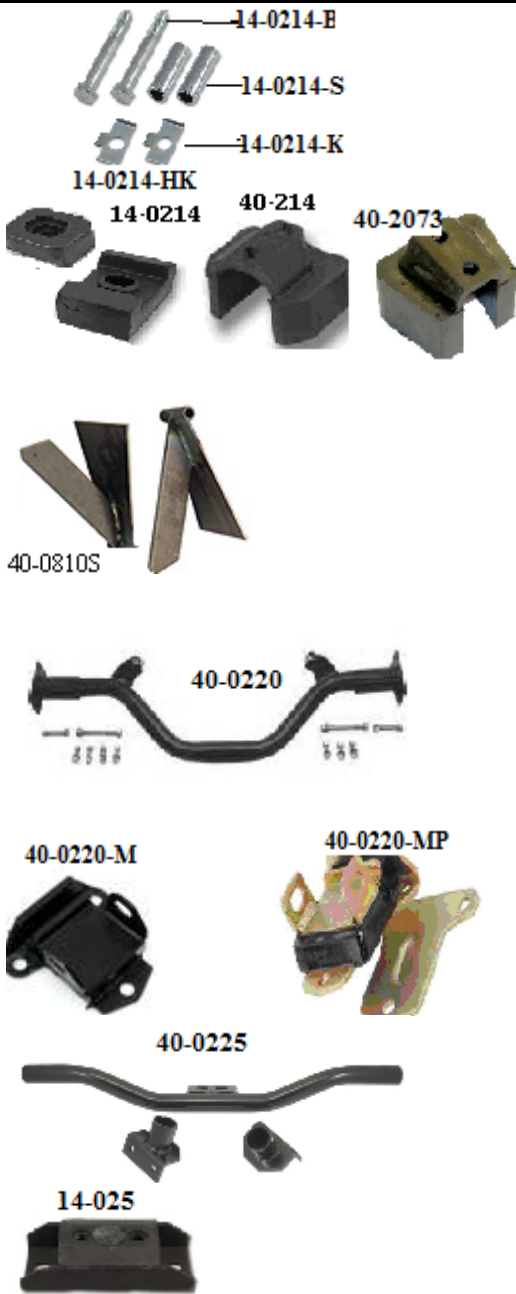

		<u>Year</u>	<u>New</u>
Rear Mount hdw			
14-0214-K	keeper to secure through bolt-each	54-59	\$7.95
Motor Mount Install hdw kit			
14-0214-HK	sleeves/bolts & locks 6 pcs 2 sides	54-59	\$26.95
Rear Motor Mounts			
14-0214	1 upper & 1 lower- also	54-59 aut trans	54-87 \$36.95
40-2073	1937-1947 Chevrolet).(1939-1959 GMC) (1947-1953, 3/4, 1, 1 1/2, 2 ton Chevrolet and GMC).(1952 -1953 GMC with Hydromantic Trans (wedge shape-3 " wide)	each	37-59 \$29.95
V8 Crossmember Adapts GM small block motors to early frames w/ hardware			
40-0220		47-59	\$119.95
V8 Motor Mount -----use w/ V8 kit 40-0220 & 40-0810S			
40-0220-M	OE rubber	each	47-59 \$22.95
40-0220-MP	Polyurethane, Zinc/Black	each	47-59 \$64.95
Transmission Crossmember Use to install standard or automatic trans.			
40-0225		54-72	\$119.95
Rear Transmission Mount Pad			
14-025	use with std / PG / 350/700 trans		\$26.95
14-025-1	turbo 400		\$34.95

Bill's Truck Shop

Phone (905) 725-3460 / (905) 725-2022



Axle Seals-rear

41-0695	1/2 ton each	38-62	\$39.95
41-081B	3/4 - 1 ton w/ out Dana rear axle-dana rear axle cover has straight sides-other axle has round cover	47-72	\$24.95

Rear Axle Bearings

41-0502-EL	outer 1/2 ton each	38-61	\$99.95
41-0503	outer bearing 3/4 and 1 ton	46-72	\$49.95
41-0504	inner axle bearing 3/4 and 1 ton	46-72	\$49.50

Pinion Nut

41-0016	7/8-16 thread- 1 1/8 OD		\$24.95
---------	-------------------------	--	---------

Pinion Seal

41-0788	1/2 ton w/ common spicer 44 rear end	55-62	\$49.95
41-0970	3/4 - 1/ ton- 1 1/2 ton- w/ open drive shaft	46-65	\$49.95

Pinion Bearing—spicer 44

41-01047

Pinion Bearing

41-0910	rear	55-62	\$174.95
41-0410	front	55-62	\$99.95

Rear Axle Plug

41-0225	1" w /gasket	47-63	\$29.95
41-0225-G	gasket (leather)	47-63	\$4.95

Bill's Truck Shop

Phone (905) 725-3460 / (905) 725-2022

Engine - Rear Axle-Trans

Group 41

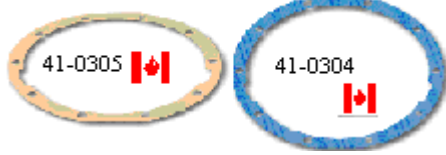

Inquire about used rear ends 1/2 - 3/4 and gear ratio

Rear Axle Cover Gasket

41-0304	1/2 - 3/4 10 bolt rear end	37-63 Chev	
	39-66 GMC 1/2 ton	1/16 (.063) thick	37-66 \$8.95
41-0088	3/4 - 1 - 1 1/2 H072-52 Eaton w/ 10 bolt cover		37-72 \$22.95

Rear Differential Carrier Gasket

41-0305	1/2 - 10 bolt rear end	37-63 & 37-45	
3/4 ton	39-70 1/2 GMC	1/32 (.031) th	37-63 \$7.95

Rear Axle Vent @ some trans

16-0270	plastic 3/8 OD	64-72	\$7.95
16-0271	metal screw in	47-63	\$24.95
16-0270-K	rear axle vent w/ hose	60-87	\$11.95

Rear End Gear Kit raise your top speed

Sleeve-rear pinion crush/non posit

41-0151		55-66	\$24.95
41-0152	1/2 w/ 8:75 rear end	66-81	\$19.95
41-0305	1/2 - 10 bolt rear end	37-63 & 37-45	
3/4 ton	39-70 1/2 GMC	1/32 (.031) thick	37-63 \$7.95

Bill's Truck Shop

Phone (905) 725-3460 / (905) 725-2022

TRANSMISSION

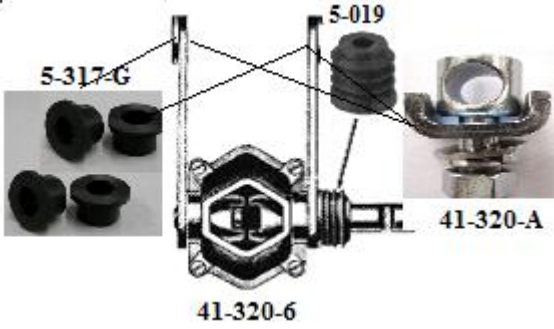

Shift Linkage Adjuster

41-320-A	each	55-59	\$18.95
----------	------	-------	---------

Shift Rod Grommet @ box & trans

5-317-G	set of 4-rubber	55-59	\$6.95
---------	-----------------	-------	--------

Shifter Boot at shift box

5-019		47-59	\$4.95
-------	--	-------	--------

Transmission-gear speedometer

41-0200	1 7/8 " long secures w/ lock tab		\$29.95
---------	----------------------------------	--	---------

63-87-- 350 aut -2 speed powerglide & some 3-4 speed Saginaw transmission speedometer driven gear-less teeth to increase odometer MPH 63 up 2" long & 62 and under 3" long

3 & 4 speed std-power glide/350

41-0221-18	Speedo driven gear-brown w/ 18 teeth	\$14.95
41-0221-19	Speedo driven gear- white w/19 teeth	\$14.95
41-0221-20	Speedo driven gear-dark blue w/20 teeth	\$14.95
41-0221-21	Speedo driven gear-red w/21 teeth	\$14.95
41-0221-22	Speedo driven gear-green w/22 teeth	\$14.95
41-0221-24	Speedo driven gear-yellow w/24 teeth	\$14.95
41-0221-25	Speedo driven gear-natural w/25 teeth	\$14.25

Retainer-Speedo drive gear-350-400-460	\$9.00
--	--------

Bill's Truck Shop

Phone (905) 725-3460 / (905) 725-2022

TRANSMISSION



The SM-420 4-speed transmission was produced by General Motors between the years of 1947 & 1967. Starting in 1966 General Motors offered the NP-435GA for its light truck applications as an option. The NP-435-GA became the standard 4-speed sometime in the late 1960s. The cast iron case with large bulge on the passenger side makes the SM-420 easy to identify. Ribbing was added to the bulge on later cases. The ribbed SM-420 case should not be confused with the later SM-465 transmission. How can you tell which 4-speed your 1966 has, if reverse is to the driver & down, it's the SM-420, if to the passenger & down

41-0SM420-TS SM420 4 speed trans



SM420 4 speed transmission parts

Tailstock/rear yoke seal		
41-0SM420-TS	47-67	\$38.95

41-03305



Transmission shifter repair kit

41-0137 4 speed floor shift	47-87	\$34.95
-----------------------------	-------	---------

Bill's Truck Shop

Phone (905) 725-3460 / (905) 725-2022

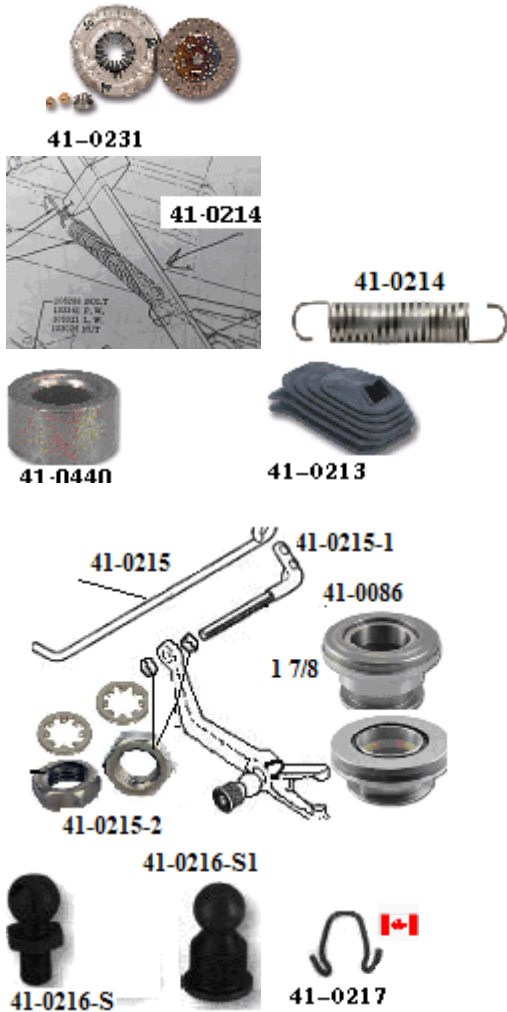

Clutch---match w/ removed parts

Year New

41-0072 NEW 11 clutch kit w/ 4 speed trans
- Spline: dia 1 1/8 w/ 10 spline includes 1 7/8 bearing,,bushing & align tool 51-62 \$239.95

Clutch Release Bearing

41-0086 6 cyl & most V8 1 7/8 long 38-75 \$69.95

41-0087 1 ¼ long 47-84 \$69.95

Pilot Bushing

41-0440 brass- fits 6 & 8 cyl 47-87 \$14.95

Clutch Pedal Return Spring @ clutch offset rod

41-0214 47-59 \$5.95

Clutch Linkage Rod

41-0215 47-59 \$17.95

Clutch Linkage Offset Rod

41-0215-1 includes 2 adj nuts 47-72 \$27.95

Nuts-Jam nut for clutch adjust rod-pr

41-0215-2 pair of adjusting nuts w/ washers 47-59 \$2.95

Clutch Fork Ball Stud

41-0216-S 3/8 " stud-6 cyl only 38-59 \$19.95

41-0216-S1 3/4 " shaft-V8 only 55-72 \$39.95

Clutch Fork Stud Retainer Clip

41-0217 38-72 \$14.95

Bill's Truck Shop

Phone (905) 725-3460 / (905) 725-2022



Automatic Column Shift Linkage kit

3-0TSL-L universal-upgrading to auto trans 47-72 \$94.95



Flywheel Cover-front upper

36-0908 3 & 4 speed trans 55-72 \$49.95

Flywheel Cover-lower

41-0477 3 & 4 speed 55-72 \$87.95



U-joint Retainer

41-0021 1 3/8 center to center each \$12.95
41-0022 1 1/2 center to center each \$12.95
41-0023 1 3/4 center to center-metric each \$11.95



Driveshaft U-joint

41-0369 U-joint w/ 3 speed or automatic 1/2 ton each 55-87 \$39.95
41-0331 U-joint w/ 4 speed @ trans (3 5/8 dia w/ 1 3/16 cup) each 55-87 \$36.95



Driveshaft Hanger Bearing Assembly

14-030-S 1.3780" ID 54-94 \$99.95
54-94 Support Driveshaft hanger bearing w/ side to side mount

Bill's Truck Shop

Phone (905) 725-3460 / (905) 725-2022

Engine

Group 41



		<u>Year</u>	<u>New</u>
Carburetor Insulation Plate			
41-0231-1	-2 15/16 mount	54-62	\$11.95
Carburetor Insulation Plate Gasket			
41-0231-G	-2 15/16 mount	54-62	4.95
Carburetor Rebuild kit -includes gaskets, accel pump, needle w/ seat & instructions NO float			
41-0158	Rochester 6 cyl	50-62	\$69.95
Carburetor Float			
41-0095	Rochester w/ 6 cyl	41-62	\$34.95
Distributor Vacuum Advance			
41-0DVA	6 cyl	37-62	\$59.95
Oil Filter Lines (pair)			
41-0249L	6 cyl	47-62	\$69.95
Oil Line Block kit - 4 pc set			
41-0249-A	2 outlet plug for oil gauge and filter line-screws in block	47-62	\$19.95
41-0249-1	1/8 pilot nut		\$2.95
41-0249-2	1/8 tube OD x 1/8 male pipe		\$5.95
41-0249-3	1/8 NPT 3 outlet female		\$7.95
41-0249-4	1/8 x 1" connector tube		\$2.35
Cartridge Oil Filter The Fram cannisters use a 7/8" wrench on the top bolt and have a crimped bottom/ black top & orange canister-fram # C4 or C4P2 The A/C cannister uses a 5/8" wrench on the top bolt and has a smooth bottom.			
41-0201-1	4 1/8 W x 5 H	FRAM	37-62 \$34.95
41-0201-2	4 1/2 W x 5 H	AC	37-62 \$29.95
41-0201-GMC	3 1/2 x 3 7/8 H	GMC ONLY	39-59 \$22.95
located on right ft of 6 cyl engine			
Oil Filter Adaptor			
41-0461	early SB V8 --- to convert from cannister filter to spin	56-68	\$69.95

Bill's Truck Shop
 Phone (905) 725-3460 / (905) 725-2022

Engine

Group 41



Accelerator Return Spring

41-0208 6cyl 50-59 \$9.99

V8 Throttle Linkage original type

41-0310 47-52 requires 55-57 gas pedal 47-59 \$89.95

Starter Pedal Return Spring

41-0211 6 cyl 47-59 \$5.50



Spring- Starter pedal return

41-0211 47-59 \$5.50

Tension spring kit-starter pedal rod

41-0211-K 47-59 \$2.95



Clips-vac & fuel

41-0195 3 pcs set secures dist vac line to fuel line 37-62 \$12.95



Cam Gear-fibre type

41-0500 Cam Gear-216/228/235/248/270 42-62 \$84.95

Bill's Truck Shop

Phone (905) 725-3460 / (905) 725-2022

41-3VC-G



41-020.B



41-020F-1



41-3AC-2



41-020A



41-3AC-3



41-0201-49

41-0201-54

41-0741



41-0301-55



Oil Filter Decals

41-020F-1 W/ Fram type -- 6 cyl engine
 41-030F-2 55-62 A/C type w/ 6 cyl & 1955 V8 w/ remote filter

Year	New
47-59	\$14.95
47-62	\$8.95

Generator Warning tag

41-0GT

47-59	\$3.95
-------	--------

Engine Decals Valve Cover

41-3VC-C Chev 6 cyl new-Thrift master
 41-3VC-G GMC---orange details
 41-3VC-GV8 GMC V 8 pair---yellow details

55-59	\$10.95
55-59	\$19.95
55-59	\$16.95

Air Cleaner Decals

41-020B dry element style
 41-020A oil bath type / angle style top -AC heavy duty
 41-3AC-2 oil bath style w/ 6 cyl
 41-3AC-3 oil bath style w/ 8 cyl w/ 2 bl

47-59	\$5.95
47-59	\$5.95
55-60	\$9.95
55-59	\$7.95

Air Breather Wing Nut

41-0741 1/4 x 20
 41-0741-10 #10 x 32

40-66	\$0.75
40-66	\$2.95

Oil Filler Cap

41-0201-49 on valve cover -twist on-not vented
 Check valve cover for vent slots -use non vented cap if cover has vents slots & vented cap w/ no vent slots in cover
 41-0201-54 6 cyl
 41-0301-55 8 cyl

49-78	\$7.50
54-67	\$12.95
55-72	\$11.95

Bill's Truck Shop

Phone (905) 725-3460 / (905) 725-2022

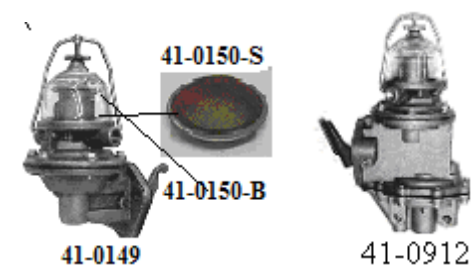
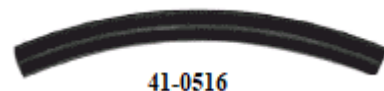
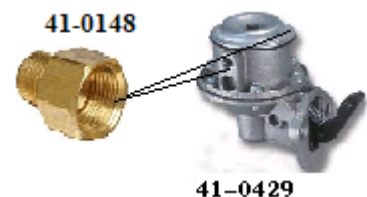



	Year	New
Gas Filter Assembly-OE GM option		
41-0668 glass bowl w/ filter -mount at carb new install requires # 41-0668-H	40-62	\$39.95
Gas Filter Fitting hdw kit- installing at carb		
41-0668-H 1 x 1/1/2 pipe—1 x straight -- 1x 90 deg line adaptor—for straight or side pipe install	40-62	\$19.95
Gas Filter		
41-0668-F filter for glass assembly	40-62	\$10.95
Gas Filter Gasket		
41-0668-G neoprene seal for glass bowl	40-62	\$4.95
Fuel Hose		
41-0516 5/16 neoprene hose ----per foot		\$3.49
41-038 3/8 neoprene hose ----per foot		\$3.49
Fuel Pump		
41-0149 w/ glass bowl type- 6 cyl	37-57	\$179.95
41-0429 w/o glass bowl 37-62 Chev/39-59 GMC when using this pump there should be a filter assembly @ carb #41-0668-also may require upper dis to line up pipe in and outlet holes OE style	37-62	\$124.95
41-0429-R w/o glass bowl 37-62 Chev/39-59 GMC when using this pump there should be a filter assembly @ carb #41-0668— this is a newer replacement style	37-62	\$74.95
41-0912 vac/fuel pump combination		
39-59 GMC & 37-62 Chev	37-62	\$159.95
41-0005 vac/fuel combination-6cyl	58-62	\$115.00
41-0006 261-GMC & 235 -6 cyl w/ electric wipers	58-62	\$149.95
Fuel Pump Rebuild kit		
41-0149-RK glass bowl AC fuel pump	37-62	\$139.95

Fuel Pump Fitting-in and out let pipe		
41-0148---fitting 1/8 NPT male x 5/16 tube OD		\$5.95

Engine-Trans Gaskets

Due to the fluctuation of the Canadian and American dollars call for current prices

Group 41

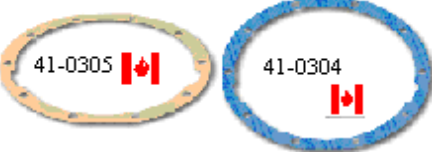
		<u>Year</u>	<u>New</u>
Transmission Gasket Set			
	41-03TG-3	3 speed Muncie 318	55-66 \$44.95
	41-02TG-4	39-72 SM420 & 48-65 Muncie 4-speed	39-72 \$39.95
Transmission Tailstock Seal w/ Bushing			
	41-0054	3 speed std	55-72 \$42.95
	41-0041	Tailstock seal	
Rear Axle Cover Gasket			
	41-0304	1/2 - 3/4 10 bolt rear end 37-63 Chev	
	41-0305	39-66 GMC 1/2 ton 1/16 (.063) thick	37-66 \$8.95
Rear Differential Carrier Gasket			
	41-0305	1/2 - 10 bolt rear end 37-63 & 37-45 3/4 ton	
	41-0304	39-70 1/2 GMC 1/32 (.031) thick	37-63 \$7.95

Bill's Truck Shop

Phone (905) 725-3460 / (905) 725-2022



SM318 Muncie transmission



		<u>Year</u>	<u>New</u>
Oil Pan Gasket set			
41-0PG-55	235 engine	55-62	\$55.95
Valve Cover Gasket			
41-0235-VC	216-235 w/ side mount bolts	53-62	\$35.95
41-0228-VC	228/236/248/270/302 GMC 6 cyl	39-62	\$49.95
Side Cover Gasket			
41-0235-SC	216-235 engine- push rod cover	53-62	\$29.95
41-0228-SC	GMC 228/236/248 6 cyl	39-62	\$29.95
Intake Manifold Alignment Sleeves			
41-0205	34-53 207 & 216 Chev CI engine/41-49 235 Chev engine / 39-59 GMC engine	34-59	\$11.95
41-0205-1	235 & 261 CI Chev engine	50-62	\$16.95
Intake-Exhaust Manifold to Cyl Head set			
41-0185	includes between intake & exhaust ,pipe to manifold etc 235 engine	50-62	\$38.95
Head Gasket 235 6 cyl engine			
41-0619-C	NEW copper style-re-torque after running	53-63	
41-0619		53-63	149.95
Thermostat Gasket			
41-0930	all 6 or 8 cyl		\$3.95
Thermostat Housing to Block Gasket			
41-0068	216--235	37-62	\$4.95
41-0235-SC	216-235 engine- push rod cover	53-62	\$29.95
Water Pump to Block Gasket			
41-0069-53		53-62	\$5.95
Rear Main Seal-upgrade/neoprene			
41-02RM-B	OE rope style	40-62	\$19.95
41-0363	replaces the OE rope seal 235-261 6 cyl	55-62	\$89.95
41-0711	replaces the OE rope seal 265-283 V8	55-58	\$45.95
Timing Cover Gasket set 228/236/248/270-52-59-302			
41-0114-TC	includes fit crank seal (1pc)	37-62	\$59.95
Timing Cover Crank Seal			
41-0842	1 pc	37-62	\$27.95
Balancer Repair kit			
41-0919	corrects groove-sleeve 6 cyl-SB v8	47-87	\$24.95
Fuel Pump Gasket			
41-0075	6 & 8 cyl		\$3.95
Push Rods	235 6 cyl		

Bill's Truck Shop

Phone (905) 725-3460 / (905) 725-2022 /

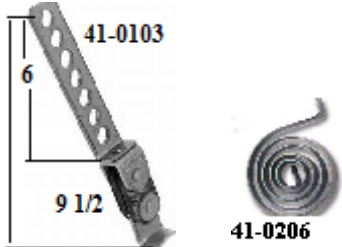
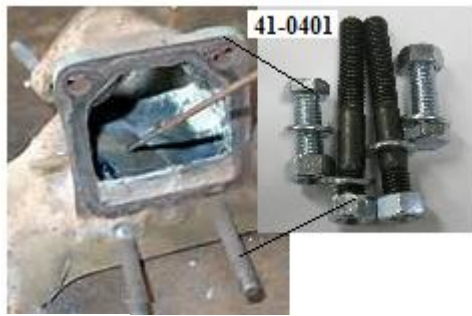

		<u>Year</u>	<u>New</u>
Exhaust to Intake bolt kit			
41-0401	2 bolts (1 ¼) & 2 studs (3 ¼) w/ hdw		\$9.95
Exhaust pipe to manifold stud			
41-0507	one stud (2 ½ long) w/ deep brass nut --each		\$9.95
41-0957	3/8 – 16 brass nut pr		\$5.40
Heat Riser Spring			
41-0206	6cyl	38-63	\$32.95
Heat Riser Gasket SB-V8			
36-0350-G		55-85	\$3.95
Exhaust Gasket-donut			
41-0400	6 cyl ft pipe to manifold 2” ID		\$6.95
Exhaust Clamp			
41-0134	1 3/4		\$4.50
41-0200	2 00		\$29.95
41-0218	2 1/8		\$3.30
41-0025	2 1/4		\$29.95
Exhaust Flange			
41-0899	3 1/8 center to center on stud		\$15.95
Muffler Strap w/ hook			
41-0235-SH		40-59	\$13.95
Tailpipe Hanger			
41-0135		47-59	\$18.95
Universal Exhaust Hanger			
41-0103			\$21.95
Muffler			
41-0035-M	21”L x 5”W 2” inlet & 1 ½ outlet	40-59	\$99.99

Bill's Truck Shop
 Phone (905) 725-3460 / (905) 725-2022

Engine – Cooling System

Group 41

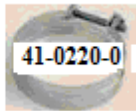
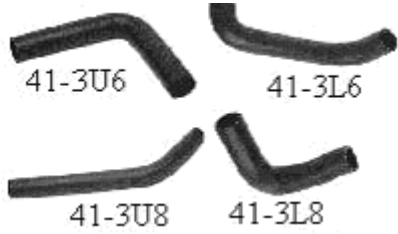

22-0205-1



22-0205



41-0007



		<u>Year</u>	<u>New</u>
Radiator Hoses- moulded hoses-235 6 cyl			
41-3U6	upper 1 1/2 size Chev w/ 6 cyl	55-59	\$42.95
41-03L6	lower 1 3/4 Chev w/ 6 cyl	55-62	\$42.95
41-03U8	upper 1 1/2 size Chev w/ 8 cyl		
V8	w/ angle up stat housing outlet	55-66	\$54.95
41-3L8	lower Chev w/ 8 cyl	55-59	\$49.95
41-02HU-B	upper 1 1/4 248/270 GMC w/ 6 cyl	55-59	\$42.95
41-3L6-G	lower 248/270 GMC w/ 6 cyl	55-59	\$46.95
Heater Hose –approx 3.5 to 4 ft required to secure on inner fender-MOST heater hoses are 3/4-CONFIRM			
18-0401	5/8 black-per foot		\$3.95
18-0402	3/4 black-per foot		\$4.25
Heater Hose Retainer w/ screw			
22-0205	original used- on pass inner fender	40-59	\$19.95
22-0205-1	heater or acc AC line retainer	40-87	\$16.95
Heater Hose Clamps			
41-0220	1 1/2 “-1 3/4 screw type	each	\$1.95
41-0220-0	up to 1 “ flat	each	\$3.25
Radiator Hose Clamps OE style screw clamps			
41-001-3/4	OE style upper 1 3/4	each	\$6.95
41-002-0	OE style lower 2”	each	\$7.95
41-0228	1 3/4”-2” wrap- screw type	each	\$2.50
41-004-3	2 1/16 – 2 1/4 OE style		\$7.95
41-0004	7/32-5/8	each	\$1.25
41-0007	5/16 – 11/16	each	\$1.25
41-0009	1/2 - 29/32		\$1.25
Radiator Cap			
41-0RC-7	7 lb OE Delco	55-62	
41-0RC-7B	7 lb		
replacement		55-62	\$12.95
41-0RC-16	16 lb rad cap for non stock engine application	47-87	\$13.95

Bill's Truck Shop

Phone (905) 725-3460 / (905) 725-2022



18-0160



18-0425-B

Thermostat

18-0160	160 deg	\$14.95
18-0180	180 deg	\$14.95
18-0195	195 deg	\$14.95

41-0FB-6

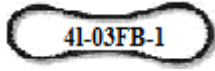

41-03FB-1

Fan Belt

41-03FB-1	Chev w/ 3/8 groove pulley 6 cyl-31 1/64 x 41 3/8	55-62	\$42.95
41-03FB-2	GMC w/ 3/8 groove pulley 6 cyl	39-59	\$27.95
41-03FB-3	GMC w/ 5/8 groove pulley 6 cyl	39-59	\$29.95

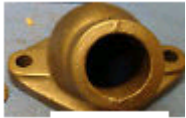

41-0453

41-0454



41-3FB-5	Chev w/ v8 engine 55" long	55-59	\$39.95
----------	----------------------------	-------	---------

Thermostat Housing

41-0453	V8 engine aluminum w/ gasket front/up	\$39.95
41-0454	V8 engine/aluminum w/gasket-angle	\$26.95

18-00HA-2



Hose Adaptors

18-00HA-1	Hose adaptors -adjusts from 1 3/4 to 2 "	\$11.95
18-00HA-2	Hose adaptors -adjusts from 1 1/2 to 1 3/4 "	\$11.95

41-0034-L



41-0034



41-0058



41-0058	5/8 hose fitting 1 1/2 ' long	\$11.95
41-0034	3/4 hose fitting 1 1/2 ' long	\$11.95
41-0034-L	3/4 hose fitting 2 1/2 ' long	\$11.95

Bill's Truck Shop

Phone (905) 725-3460 / (905) 725-2022

Engine - Radiator

Group 41

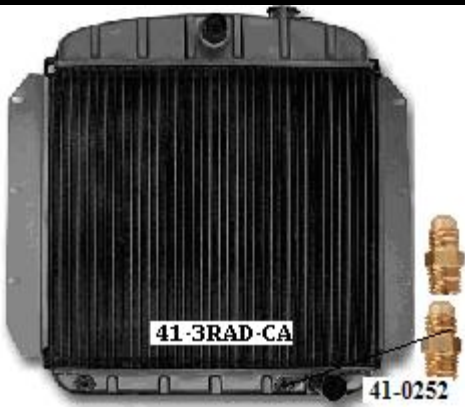

Radiator- OE style replacement modern tube-fin type cores w/side support brackets-1 ½ top & 1 ¾ lower outlet dia. **COPPER-BRASS**
Please use correct lb rad cap

Year New

With AUT TRANS COOLER w/ 3 row cooling tubes
41-3RAD-CA 6 & 8 cyl w-aut trans Chev
w 19 7/8 H x 23 3/8 W x 3 core-**requires fittings**
41-0252 when installing auto trans copper-brass

55-59 \$899.95

Trans Cooler Auto Fittings-required w/ aut lines

41-0252 12 x ½ x ¼ NPT 9/16 drive pair \$19.95

NEW ALUMIMUM - not polished

. These radiators are high efficiency cores with 1" cores. Core size is 19 1/4" x 22 3/4". X 2" thick Inlet is 1 1/2". Outlet is 1 3/4". These are welded construction there is no epoxy used in these radiators.--**Transmission Cooler Included** (1/2"-20 Straight Thread, inverted flare

41-3RAD-CA-B aluminum 3 row w/ auto cooler, 14 lb rad cap V8 application

55-59 \$424.95

41-3RAD-CA-BB aluminum-**BLACK** 3 row w/ auto cooler V8 application 14lb rad cap

55-59 \$445.95

41-3RAD-CA-LS ALUMINUM - w/ LS engine update radiators are high efficiency 3 row cores for maximum cooling. w/steam blow outlet all on pass side--

55.59 \$449.95

41-3RAD-CA-2B 2 row w auto cooler 14 lb cap 6 cyl----- Core--19.38" tall x 21.75" wide x 1.75" thick-- Inlet is 1 1/2". Outlet is 1 3/4".--allows clearance for the 235 fan-rad 6 cyl application -- **please confirm engine & trans mounts are in good condition-fan sits close to rad**

55-59 \$349.95

Fan Shroud

41-3FS-1 aluminum shroud accepts 1 single 16" electric fan 19 1/3 H x 21 ¾ W

55-59 \$149.95

41-3FS universal/plastic-side mount

55-59 \$114.95

Hose-rad overflow drain 30" 3/8 thin walled-ribbed hose

10-00FH \$9.95

Radiator Petcock

41-0254 ½ pipe brass 40-87 \$8.95

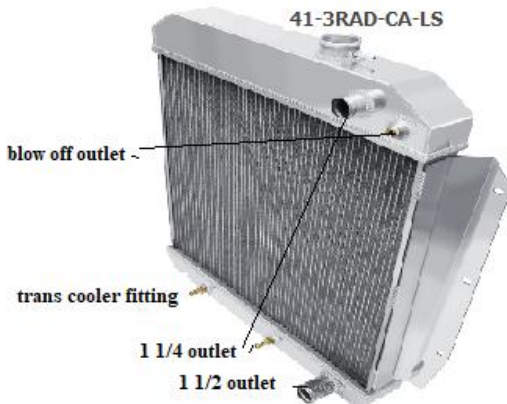

Bill's Truck Shop

Phone (905) 725-3460 / (905) 725-2022



Electric Fan

44-0016 Produces a 1600 CFM Rating at 18.4 or 14 amp draw.

- This fan is 3 1/4" deep through the center of the motor; it gradually thins to 1 1/2" at the outer edge
- Curved blades are quiet and push the same amount of air as a straight blade.
- Factory built as a puller, mounted inside and pulls the air through the radiator.
- 12V REVERSIBLE 'S' BLADE - Blades & polarity of the wiring can be reversed & it becomes a pusher

universal \$99.95

44-0014 13.82 " wide//2 58 " deep 1200 CFM
12 V 90 W reversible

universal \$99.95

44-0012 12 " wide 870 CFM 12 V reversible

universal \$89.95

Relay-electric fan control

44-0016-R This adjustable electric fan switch with thermostat allows you to set the in and out temp

universal \$42.95

44-0016-S

This Electric Fan Relay with Thermostat kit allows you to run your electric cooling fan in a much more efficient manner.

It powers up your electric fan when your motor reaches - 175-185 degrees F and powers down when your motor reaches 170 degrees F w/ temp sender 50-60 amp relay

universal \$69.95

44-0016-SD

Dual fan relay Kit, 80 Amps, 12V, temp sender, two 40 Amp relays, On at 195 degrees, Off 180 degrees, Harness, Kit

universal \$114.95

Bill's Truck Shop

Phone (905) 725-3460 / (905) 725-2022

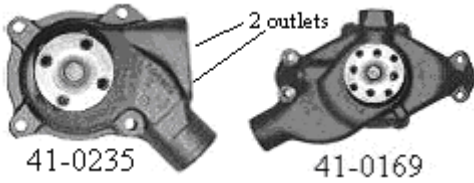

Water Pump \$15.00 core charge w/out old pump
NEW or noted as rebuilt

41-0235	Chev	w/ dual outlet-includes 1 plug-NEW	55-62	\$169.95
41-0235-1R	Chev	-rebuilt 6 cyl OE style w/ single outlet	55-62	\$139.95
41-0235-2R	GMC	w/3/8 groove pulley 6 cyl rebuilt	39-59	Inquire
41-0167-R	GMC	w/ 5/8 groove pulley 6 cyl rebuilt	39-59	Inquire

Bill's Truck Shop

Phone (905) 725-3460 / (905) 725-2022

Engine – Ignition

Group 41



41-02SP-49



41-02PW-6

41-03PW-8



36-0704



36-0703

36-0705



36-0083



41-0168-12



41-0774



41-3PC



41-0PC



41-0D-235



41-0HE1

Spark Plugs

41-02SP-49 6 cyl 49-62 \$7.95

Spark Plug Wire Set w/ sealed plug caps

41-02PW-6 6 cyl 7 mm 47-62 \$59.95

41-03PW-8 small block V-8 w/ point ignition 55-72 \$44.95

Spark Plug Wire Retainers-V8

36-0704 rear w/ small block 4 wire- L & R each 58-69 \$8.95

36-0795 secures on oil pan/2 wire-L & R side each 58-72 \$7.95

36-0703 secures @ heat shield on block 2 wire each 58-72 \$4.95

Spark Plug Shields

36-0083 V8 set of 4 57-72 \$34.95

Electronic Ignition-Solid state electronic system fits entirely inside distributor. Easy to install. 12 volt 216, 235 and 261 cubic inch engines

41-0168-12 54-62 \$225.00

Ignition Points w/Condenser

41-03PC 6 cyl 47-62 \$49.95

41-3PC V8 55-56 \$45.95

41-0PC V8 57-74 \$24.95

Grommet-Dist wire v8 only

41-0774 57-74 \$3.50

Bill's Truck Shop

Phone (905) 725-3460 / (905) 725-2022

Engine – Ignition

Group 41



41-02DC-53

41-03DC



41-02DR-53

41-3DC-55



41-03DR-57



41-03DR-55



41-2IC-6



18-0203

Dist Cap

41-02DC-53	6 cyl dist cap	53-62	\$45.95
41-3DC-55	V8 w/ side clips retainers	55-56	\$51.95
41-03DC	V8 w/ side screws	57-74	\$39.95

Dist Rotor

41-02DR-53	6 cyl dist rotor	53-62	\$28.95
41-03DR-57	V8	57-74	\$11.95

Ignition Coil

41-2IC-6	6 volt		\$44.95
41-02IC-12	12 volt		\$42.95

Ignition Resistor

18-0203	reduces 12v to 9v		\$29.95
---------	-------------------	--	---------

Bill's Truck Shop

Phone (905) 725-3460 / (905) 725-2022

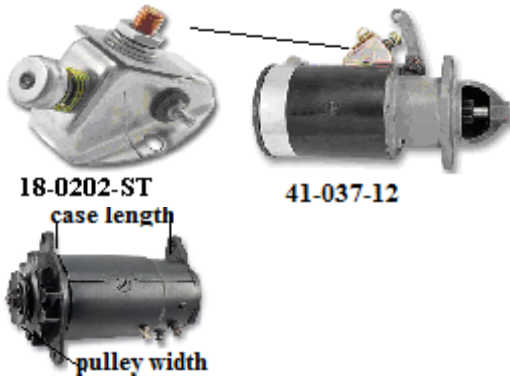

CORE CHARGE apply to starter & gen \$25.00

Starter-----REBUILT

41-037-12	6- cyl 12 volt w/ ft start	55-59	\$349.95
41-037-12S	6 cyl 12 volt w/ key start	55-62	\$349.95
41-025-12S	V8 w/ key start solenoid—inquire w/ end housing style of application	57-62	\$349.95
41-027-12/6	6 cyl 12V starter converted to 6V for 55-62 235 engine	55-62	\$349.95



Starter Solenoid

41-0300	w/ ignition terminal w/ key start	55-75	\$59.95
---------	-----------------------------------	-------	---------

Starter Brush set

41-0059		41-62	\$15.95
---------	--	-------	---------



Roof Light

17-0033-K	above lights w/ harness,switch & 5 lights (3" wide-8 3/4 long)		\$224.95
-----------	--	--	----------

Bill's Truck Shop

Phone (905) 725-3460 / (905) 725-2022 / Fax (905) 404-2302 email: bill@billstruckshop.com

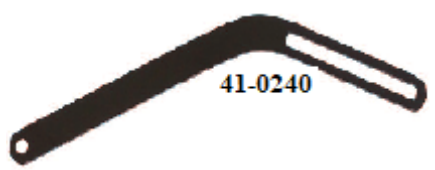
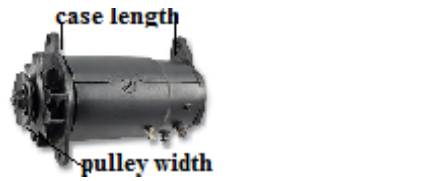

CORE CHARGE apply to starter & gen \$25.00
Generator-----confirm 3/8 OR 5/8 pulley and 6
 “ or 7 “ case

41-0G-6V	6 volt	REBUILT	47-63	\$349.95
41-0G-12V	12 volt	REBUILT	47-63	\$295.00

Voltage Regulator-replacement ----neg ground

18-210-6	6v w/ screw on terminals	40-55	\$269.95
18-0210-12-25	12 volt w/ 25 amp gen	47-62	\$69.95
18-0210-12-35	12 volt w/ 35 amp gen	47-62	\$69.95
18-0210-HK	OE style set of 3	47-62	\$1.95

Generator Tag----not numbered

41-000T	w 12 volt gen / includes rivets	55-62	\$8.95
---------	---------------------------------	-------	--------

Alternator-1 wire activates on RPM-NO voltage regulator required

19-0055	12 volt- 55 amp-	\$229.95
19-0033	female integral alt plug w/ terminals	\$7.95

Alternator Brackets -lower 6cyl 235 cyl engine

41-3AB	converts gen to alt -may require reshaping adjustment brace	55-62	\$99.95
--------	---	-------	---------

Generator Bracket-adjust

41-0240	283 & 327	55-62	\$39.95
---------	-----------	-------	---------

Alt Belt

41-0405	3/8 x 41 1/8	\$19.95
---------	--------------	---------

Bill's Truck Shop

Phone (905) 725-3460 / (905) 725-2022

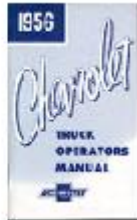
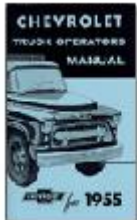

42-355M

Shop Manual --Chev
Fully illustrated Includes data, specifications, wiring diagrams etc. to repair your truck. **Supplement** issue requires previous year manual

	<u>Year</u>	<u>New</u>
42-3SM-55	55-55	\$36.95
42-3SM-56	55-56	\$15.75
42-3SM-57	57-57	\$36.95
42-3SM-58	58-58	\$49.95
42-3SM-59	59-59	\$24.95

Shop Manual -- GMC

42-3SM-GMC	55-59	\$29.95
------------	-------	---------

Owners Manual With GM plastic folder.

Chevrolet

42-355C	55-55	\$22.95
42-356C	56-56	\$22.95
42-357C	57-57	\$22.95
42-358C	58-58	\$22.95
42-359C	59-59	\$22.95

GMC

inquire about others

42-355G	55-56	\$17.95
---------	-------	---------

Accessory Installation Manual Detailed illustrations of all accessories and explains how they are installed

42-355M	55-55	\$14.95
42-356M	55-56	\$14.95
42-357M	57-57	\$14.95
42-358M	58-58	\$14.95
42-359M	59-59	\$14.95

Wiring Diagram

42-3WD-55	55-55	\$9.95
42-3WD-56	56-56	\$9.95
42-3WD-57	57-57	\$9.95
42-3WD-58	58-58	\$9.95
42-3WD-59	59-59	\$9.95

Bill's Truck Shop

Phone (905) 725-3460 / (905) 725-2022

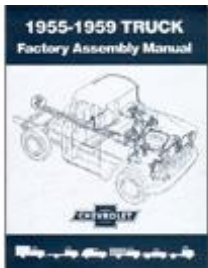

42-2TRG

Factory Assembly Manual Exploded views of the assembly of the trucks. Pertains to all years and GMC also.

42-3FAM

Year

New

55-59

\$54.95

Power Steering Repair Manual







42-3PSM

55-59

\$6.00

Bill's Truck Shop

Phone (905) 725-3460 / (905) 725-2022

		<u>Year</u>	<u>New</u>
 44-0303	 44-030	Exhaust Deflector (each)	
		44-0303	\$34.95
 44-028	 44-0255-15	License Plate Fasteners	
 44-0TV		44-028 Chrome bullets set of 4	\$4.95
		44-029 stainless steel carriage bolts w/ hdw set of 4	\$2.95
		44-030 4 nylon nuts w/ w screws	\$6.95
 44-3151			
<p>Traffic Light Viewer Repro of factory accessory. 44-0TV Used to assist in seeing the traffic light when truck had outside sunvisor</p>			\$89.95
<p>Door Vent Shades Original GM option</p>			
	44-3151 stainless steel pair	47-59	\$74.98
<p>Rad Overflow Tank</p>			
	44-0255-15 15 " polished stainless steel	universal	\$89.95
	44-0255-13 13 " polished stainless steel	universal	\$79.95

Bill's Truck Shop

Phone (905) 725-3460 / (905) 725-2022



44-0PVC Accel pedal w/chrome vertical bars, rubber insert, spring loaded, adjustable arm & L or R mount universal \$109.95



44-0TBS-2 Throttle cable bkt w/ 350/400 kickdown adapt stainless steel universal \$34.95

44-0TBS Accel bkt a@carb w/ return springs stainless steel universal \$29.95

44-0TBS-1 Accel bkt bkt @ engine w/ return springs-stainless steel universal \$19.95

7-0007 Accel spring set universal \$14.95



Adjustable Throttle Cables

44-0TC-24 24" long/black coating universal \$34.95

44-0TC-24-SS 24" long/stainless steel universal \$54.95

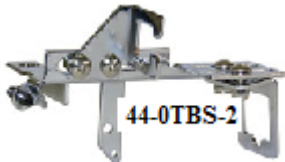

19-0412 \$178.95

Torque Converter Lockup Kit, Pressure Switch, In-line Fuse, GM, 200-4R, 700R4, Kit

Bill's Truck Shop
 Phone (905) 725-3460 / (905) 725-2022



Custom Designed System is Easy to install, The Hurricane unit mounts to firewall using existing original heater mounting holes and includes new plastic glove box. Heater fittings will pass neatly through the firewall under the battery tray with a custom rubber grommet.

w/ electronic control

Complete systems include: Inside Package (Hurricane Unit, Wire harness w/ deluxe control, Louvers, Duct Hose, Expansion Valve, Mounting Bracket & hardware) Compressor, Compressor Bracket, A/C Hose Kit and Condenser Assembly.

50-55-9005 55-57 Inquire

50-58-9008 58-59 Inquire

Complete, w/ Deluxe Electronic Control- Includes a new electronic deluxe lever style heater control that fits into original dash opening. The electronic Hurricane Unit features High Torque electric servo motors to operate the Bypass Heater Valve and Defrost Functions

50-55-9100 55-57 Inquire

50-58-9105 58-59 Inquire

Inside Package - Hurricane Heat Cool & Defrost Unit, Deluxe Control, Wire Harness, Heater valves, Expansion Valve, Duct Hose, Louvers, Plastic Glove Box, Mounting Brackets and Necessary Hardware.

50-55-9100-IP w/ electronic control 55-59 Inquire

50-55-9000-IP w/ manual control 55-59 Inquire

NOTES

Comp upgrade for Chrome or Polished finish Compressor Bracket, (varies by engine application- water pump Application info 1955-57 and 1958-59 Chev or GMC

Vents	in dash	w/ 2 1/2 inlet		
50-0125-R	louvered-round-chrome		each	\$19.95
50-0125-RT	louvered-rectangle-chrome		each	\$15.95

Ducts	" Y " 2 1/2			
50-0225-R	round w/ 2 1/2 outlets	each		\$13.95

Hose	plastic 2 1/2			
50-0325	6 ft			\$15.95



50-0125-R



50-0125-RT



50-0225-R



50-0325



Bill's Truck Shop

Phone (905) 725-3460 / (905) 725-2022



40-0175BCS



45-3559-DL

15-0301



45-0PSCV



angle mount

Column Saver kit allows reusing the original column w/ Mustang II front ends or any other replacement steering box—installs housing w/ bearing in original column—complete w/ instructions

40-0175BCS	47-59 GM trucks & cars w/ 1 3/4 column	47-66	\$144.95
40-0150BCS	GM trucks & cars w/ 1 1/2 column	48-64	\$89.95

Power Steering Custom Drag Link

45-3559-DL	custom drag link for 400 series power steering box—adjustable (helps correct steering return on turns)	55-59	\$144.95
------------	--	-------	----------

Power Steering Pump Bkt kit- fits small block Chev w/ long or short neck water pump—will require additional crank pulley

15-0301			\$69.95
---------	--	--	---------

GM power steering pump & alt bracket kit- fit early 235 engine 1955-1962—pump not included---angle mount on block

41-0PSK-235		55-62	\$374.95
-------------	--	-------	----------

These brackets require the use of an alternator and will not work with a factory generator. Complete bolt on assembly—requires a double pulley on power steering pump

Power Rack Control Valve w/ adapt fitting

45-0PSCV	when using early power steering pumps on mustang steering rack		\$24.95
----------	--	--	---------

Bill's Truck Shop

Phone (905) 725-3460 / (905) 725-2022

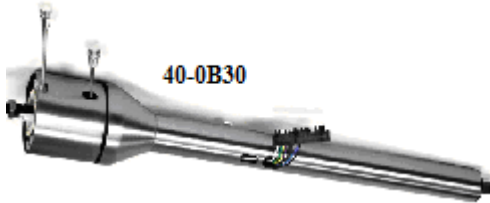

Tilt Columns-w/ new style GM signal switch w/ flat 3 7/8 flat plug
 NO P/N-rev switch

UNIVERSAL APPLICATION

Includes shift levers & indicator w/ shift-use your OE support -add support bushing # 5-0316 & lower column seal #7-308-4

40-0B33-S Tilt Column-33"/black -aut-1" DD shaft	\$699.95
40-0B32 Tilt column-32"/black-no shift/1"DD shaft	\$699.95
40-0B32-S Tilt Column-32"/black -aut-1" DD shaft	\$699.95
40-0B30 Tilt Column-30"/black-no shift/1"DD shaft	\$699.95
40-0B30-S Tilt Column-30"/black -aut-1" DD shaft	\$699.95
40-0B33-S Tilt column-33" /black w/ aut 1" DD shaft	\$699.95

IDIDIT STEERING COLUMNS US MADE

1955-59 Chevy Truck column comes with it's own specially designed under dash mount and floor mount with gasket, 1" DD output shaft .columns are available in steel (S)-chrome-(C)-brushed (BA) or polished aluminum-(PA)-black powder coated-(PB)

8 position tilt, cancelling turn signals,4 way flasher, retro style levers, neutral safety switch-3 7/8 flat signal harness plug, 1" DD output shaft

40-3140-TAS tilt, aut, paintable steel	Inquire
40-3140-TS tilt, no shift, paintable steel	Inquire
Shift Indicator -required on all columns acrylic-stick on	
3-0010-3 w/3 speed auto	\$44.95
3-0010-4 w/4 speed auto	\$44.95

40-0804 Transmission shift kit –GM 2 “ column mount/ 6’ cable w/all bkts & hdw	\$119.95
TH350, TH400, 700-R4, TH200, 200-R4, 4L60 and 4L80E	



Steering Shaft –u-joint when joining new columns to new steering systems (eg 3/4-30 spline to double D shaft)
 CNC machined Billet Steel- **always drill a dimple in shaft where set screw seats**

41-0UJ1	9/16-26 x 3/4-DD (mustang manual rack)	\$109.95
41-0UJ2	3/4-36 x 3/4 round	\$69.95
41-0UJ3	3/4-30 x 3/4-DD	\$109.95
41-0UJ3-B	3/4 -30 x 3/4 DD BLACK	\$54.99
41-0UJ4	3/4 -36 x 3/4 - 36	\$109.95
41-0UJ5	3/4-36 x 3/4-DD (mustang power rack)	\$79.95
41-0UJ5-B	3/4-36 x 3/4 DD BLACK	\$59.95
41-0UJ6	3/4-DDx3/4-DD	\$89.95
41-0UJ7	1-DDx3/4-DD	\$79.95
41-0UJ9	13/16-36 x 3/4-DD	\$109.95
41-0UJ16	3/4-DD x 3/4 smooth	\$109.95
41-0UJ17	3/4 DD x 17MM	\$109.95
41-0UJ18	3/4- 36 x 1-DD	\$109.95
41-0UJ24	3/4-30 x 1-DD	\$109.95
41-00SS	3/4 steering shaft support	\$39.95

Double Steering u-joint

41-0DUJ6	3/4DD x 3/4 “ DD	\$179.95
41-0DUJ32	3/4-36 x 3/4 “DD	\$199.95
41-0DUJ98	1” DD x 3/4”DD	\$179.95
41-0DUJ98-B	1” DD x 3/4 “ DD black	\$89.95

Steering Rag Joint

41-0R30	1”DD x 3/4 -30 spline	\$134.95
41-0R36	3/4 -36 x 11/16 -36	\$134.95
41-0R36-3/4DD	3/4”DD x 11/16 -36 spline	\$134.95
41-0R366-3/4DD	3/4 DD x 3/4-36 spline	\$134.95
41-0R36-1DD	1”DD x 3/4 -36 spline	\$134.95
41-0R366-1DD	1DD x 11/16 -36 spline	\$134.95
41-0R310	1”DD x 3/4” DD	\$134.95

Steering Rag Joint (mini 2 7/8 OD)

41-0R324-M	1”DD x 3/4 30 spline	\$114.95
41-0605S	3/4 DD x 3/4 30 spline x 3/4 round- includes drift pin-----w/ using cut OE column	\$79.95

Steering Shaft Coupler

41-0SC36	3/4 DD x 3/4 x 36	\$75.00
----------	-------------------	---------



Column Saver kit allows reusing the original column w/ Mustang II front ends or any other replacement steering box- installs housing w/ bearing in original column-complete w/ instructions

40-0175BCS	47-66 GM trucks & cars w/ 1 3/4" column	47-59	\$144.95
40-0150BCS	47-66 GM trucks & cars w/ 1 1/2" column	47-59	\$89.95
40-0150BCS-A	47-59 GM trucks & cars w/ 1 1/2" column w/ 3/4 x 3/4 DD U-joint & stub shaft	47-59	\$134.95

40-1850-DD	BLACK- steel 18"		\$64.95
40-1850-DDN	nickel plated 18"		\$64.95

40-3650-DD	unplated steel 36"		\$69.95
------------	--------------------	--	---------

40-1870-3/4N	nickel plated 3/4" round x 36 spline 24" long		\$79.95
--------------	---	--	---------

Collapsible Steering Shaft

40-0626-AD	1" DD to 3/4" DD Adjustable steering shaft 16" to 26" nickel plated		\$119.95
40-0636-AD	1" DD to 3/4" DD Adjustable steering shaft 24" to 35" nickel plated		\$129.95

Intermediate Shaft & Flange

40-00SF	9 1/4" w/ rag joint flange -accepts 3/4" shaft w/ dust boot- operates as a collapsible safety shaft		\$39.95
40-00SR	4" long 3/4" round input end w/rag joint flange end-drill & pin to column shaft (recommend welding tube to shaft)		\$39.95

Upper Column Support

40-0CS-2x2.5	polished aluminum 2" shaft	47-59	\$99.95
--------------	----------------------------	-------	---------

Lower Column Support w/ booth @ floor

40-0LCS	swivel polished aluminum w/o boot		\$104.95
---------	-----------------------------------	--	----------

Bill's Truck Shop

Phone (905) 725-3460 / (905) 725-2022

PERFORMANCE ACCESSORIES

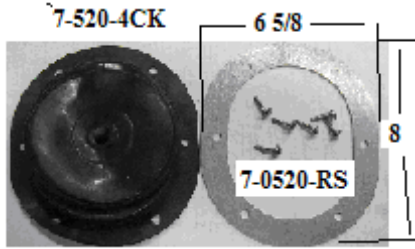

7-520-4CK	4 Speed Shift Boot	\$41.95
7-0520-RSS steel w hdw	Retainer- brushed stainless	\$34.95



Torque Converter Lockup Kit , Pressure Switch, In-line Fuse, GM, 200-4R, 700R4, Kit 19-0412	\$179.95
--	----------

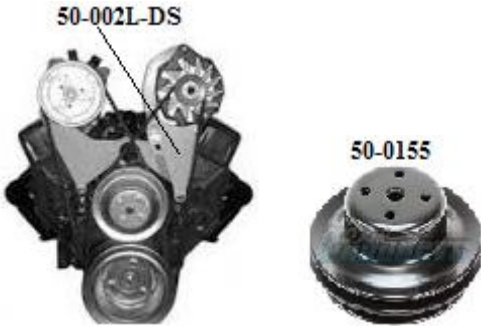

Power Steering Pulley	
15-0508 Double pulley/nut on-replaces GM 3941107	\$69.95
15-0810 single groove-press on-back spaced-replaces GM 3834720	\$69.95



Alt bkt kit	
50-002L-DS drivers side mount / small block Chev w/ long neck water pump-top mount	\$136.40
50-002S-DS drivers side mount / small block Chev w/ short neck water pump-top mount	\$136.40

Water Pump Pulley	
50-0155 5.5" in w/6" outer double pulley @ water pump 2 ¼ hole spacing replaces GM # 14023155	\$129.95
50-0142 6" double pulley -w/ short neck water pump w/ 1 ¼ hole spacing replaces GM # 3995642	\$94.95
50-0142-C	

Bill's Truck Shop

Phone (905) 725-3460 / (905) 725-2022

BRAKES

PRE-5564



PRE-9



PRE104-3824

36-0PCH



17-0BV-B



45-0213-M

45-0213



Intake Vacuum Port

17-0VP-1 1 port hose fitting - 3/8 intake hole- for power brakes

\$29.95

Brake Booster & PCV Hose

36-0PCH 3/8 x 35" w/ clamps

\$24.95

Brake Booster Check Valve

17-0BV-B black

\$12.95

Universal brake booster

45-0DD8 8" dual diaphragm zinc plated

\$169.95

Pedal Pad-universal

45-0213

\$49.95

Pedal Pad Mount-universal

45-0213-M

\$49.95

Bill's Truck Shop

Phone (905) 725-3460 / (905) 725-2022

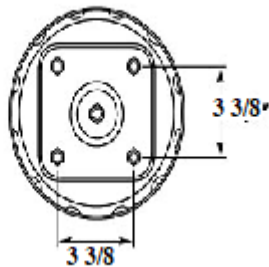
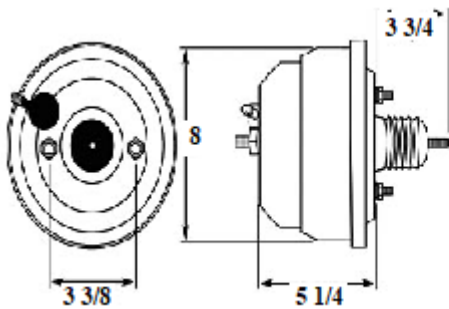

BRAKES



Proportioning Valves

17-0PVKS-2	Brake Proportioning Valve -disc/drum w/ lines-when converting to disc- ft-drum rear	BRASS	\$149.95
17-0PVKS-4	Brake Proportioning Valve -disc/drum w/ lines-when converting to disc-disc	BRASS	\$149.95
17-0PVKS-A4	Brake Proportioning Valve -disc/drum & or disc/drum w/ lines & bracket	ALUMINUM	\$159.95

Harness-proportioning valve switch

17-0PVK-H	replacement harness w/ socket	\$12.95
-----------	-------------------------------	---------

Disc Brake kit

45-0WBK-5	47-59-5 lug disc brake kit —uses stock ½ spindles & hubs Kit includes rotors, callipers, brackets, flex hoses and hardware Bearing upgrade(tapered roller w/ seals) may not work with stock wheels	47-59	\$724.95
-----------	---	-------	----------

45-0WBK-6	47-59-6 lug disc brake kit —uses stock ½ spindles & hubs/ kit -includes rotors, callipers, brackets, flex hoses and hardware-Bearing upgrade(tapered roller w/ seals) is recommended-calipers may not work with stock wheels	47-59	\$799.95
-----------	---	-------	----------

38-04759-BK	Wheel Bearings kit -upgrades to tapered roller bearings w/ grease seals ½ ton only	47-59	\$224.95
-------------	---	-------	----------

38-04759-S	Grease seal -replacement for bearing kit	each 47-59	\$13.95
------------	---	------------	---------

45-0DBK-5	47-59 Disc brake upgrade bkt kit	47-59	\$174.95
-----------	---	-------	----------

5 x 4 ¾ bolt pattern-add callipers, 11", rotors w/ bearing upgrade kit, brackets, flex hoses and hardware-bolts to stock spindles. Converts your straight axle to disc brakes-used factory holes on ½ ton spindle-kit includes calliper brackets, bearing adaptors & hdw-used 70-77 Camaro rotors & callipers- will also have to upgrade to dual master & prop valve

17-0BR13	Inner wheel bearing	each	\$16.95
17-0BR2	Outer wheel bearing	each	\$14.95
17-0984	grease seal	each	\$6.95

Bill's Truck Shop

Phone (905) 725-3460 / (905) 725-2022



55-59 Firewall mount brake booster kit-bolts to firewall(remove original column support) includes mount bracket, pedal w/ linkage, 8 "booster, master cylinder 1" bore, & prop valve -Add # 45-0134 mechanical brake light switch

45-3559-FB4-8 disc-disc & disc drum \$649.95

45-3559-FB bracket w/ pedal only \$245.00

55-59 Frame **mount brake booster**-bolts in the stock location using original pedals-includes 8" dual diaphragm booster, 1 " bore master cylinder, proportioning valve, mount bracket w/ hardware & prop valve - brake lines will need modifying

45-3BBD-8D drum-drum application -no prop valve \$589.95

45-3BBD-8DD disc-disc & disc drum application \$679.95



45-3BBD-SDD

45-3BB-7-P disc- drum w/ prop valve, 1" master, 7" dual diaphragm & pedal assembly w/ hdw \$495.95



45-3BB-7-P



55-59 Rear say bar kit (w/ stock suspension)-helps reduce roll and increase steering stability-complete w/ 7/ 8 bar, poly bushing, brackets and hardware will mount on stock and flip applications w/ rear axle tube to 3" dia

40-3RSB \$299.95



45-3559-FSK

55-59- Front sway bar-(w/ stock suspension) original style-helps improve driveability by reducing roll and lane darting-kit complete w/ hardware and instructions 1" bar-w/ original I-Beam

45-3559-FSK \$249.95



45-3559-FSK-P

55-59- Front sway bar-(w/ stock suspension) helps improve driveability by reducing roll and lane darting-kit complete w/ hardware and instructions 1" bar-performance upgrade w/ V8 engine @ original I-Beam

45-3559-FSK-P \$279.95



Power steering pitman arm when converting to power steering box

45-0759PA-PS standard height \$79.75

45-0759PA-PR reversed for lowered trucks \$74.75

HARDWARE

49-0610	5/16-18 x 7/8 w/11/16 floating washer-NC	each	\$1.65
49-0612	5/16-18 x 1 w/7/8 floating washer-NC	each	\$2.10
49-0613	5/16 -18 x 3/4 w/ washer head -NC	each	\$2.25
49-0614	3/8-16 x 1 w/ 1 floating washer-NC	each	\$2.95
49-0615	3/8 -16 x1 1/2 w/ 1 1/8 floating washer NC	each	\$3.25
49-0710	5/16 - 18 U - nut	each	\$2.20
49-0620	5/16 -18 x 3/4 w/ OE style washer head NC	each	\$1.65
49-0621	5/16 -18 x1 1/16 dog point w/ floating washer-each		\$1.75
49-0622	5/16 -18 x 15/16 dog point w/ floating washer-each		\$1.95

BODY ALIGNMENT SHIM-galvanized steel

20-000D	1/16 w/ 3/8 slot shim	each	\$1.25
20-000E	1/8 w/ 3/8 slot shim	each	\$1.45
20-000K	8 pc Shim kit 4 x 1/16 and 4 x 1/8	set of 8	\$10.95

Totally Stainless bolt kits

Every Body Kit includes component kits-for Front Bumper, Door Hinges, Door Latch & Catch, Fender to Firewall Brace Rods, Front & Inner Fenders, Grill & Gravel Pan, Headlight & Parking Lens, Hood Hinges, Hood Latch, Catch & Braces, Interior, Outside Mirror, Radiator Support, and Regulator & Relay.

49-3324	55-55 Chev -Body Bolt kit- 18-8 stainless steel w/ indented hex bolts-OE style /cab forward does not include bed any bed hdw		\$369.95
49-3238	56-57 Chev -Body Bolt kit- 18-8 stainless steel w/ indented hex & Philips head bolts & -OE style /cab forward does not include bed any bed hdw		\$499.95
49-3294	58-59 Chev -Body Bolt kit- 18-8 stainless steel w/ indented hex bolts-OE style /cab forward does not include bed any bed hdw		\$499.95



Bill's Truck Shop
Phone (905) 725-3460 /

Chevrolet Chassis Identification

Years	Series & Model	Class	Wheelbase	Bed Type
1955 2nd Series	3100 3104	1/2 Ton	114"	Stepside
	3124	1/2 Ton	114"	Fleetside
	3200 3204	1/2 Ton	123-1/4"	Stepside
	3600 3604	3/4 Ton	123-1/4"	Stepside
1956-1957	3100 3104	1/2 Ton	114"	Stepside
	3124	1/2 Ton	114"	Fleetside
	3200 3204	1/2 Ton	123-1/4"	Stepside
	3600 3604	3/4 Ton	123-1/4"	Stepside
1958	3100 3104	1/2 Ton	114"	Stepside
	3124	1/2 Ton	114"	Fleetside
	3134	1/2 Ton	114"	Fleetside
	3154	1/2 Ton	114"	Stepside
	3200 3204	1/2 Ton	123-1/4"	Stepside
	3234	1/2 Ton	123-1/4"	Fleetside
	3600 3604	3/4 Ton	123-1/4"	Stepside
	3634	3/4 Ton	123-1/4"	Fleetside
	3654	3/4 Ton	123-1/4"	Stepside
	3684	3/4 Ton	123-1/4"	Fleetside
	1959	3100 3104	1/2 Ton	114"
3134		1/2 Ton	114"	Fleetside
3154		1/2 Ton	114"	Stepside
3200 3204		1/2 Ton	123-1/4"	Stepside
3234		1/2 Ton	123-1/4"	Fleetside
3600 3604		3/4 Ton	123-1/4"	Stepside
3634		3/4 Ton	123-1/4"	Fleetside
3654		3/4 Ton	123-1/4"	Stepside
3684		3/4 Ton	123-1/4"	Fleetside

1955-59 Chevrolet Serial Identification Number

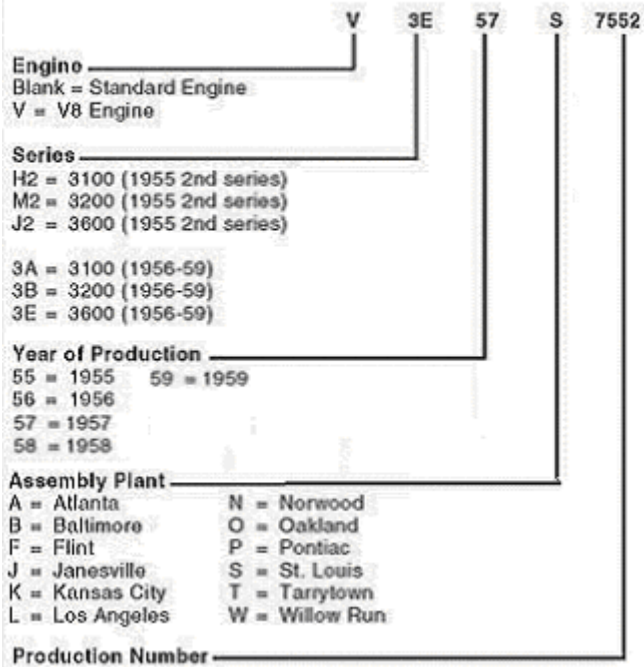

1955-59 2nd Series GMC Serial Identification Number

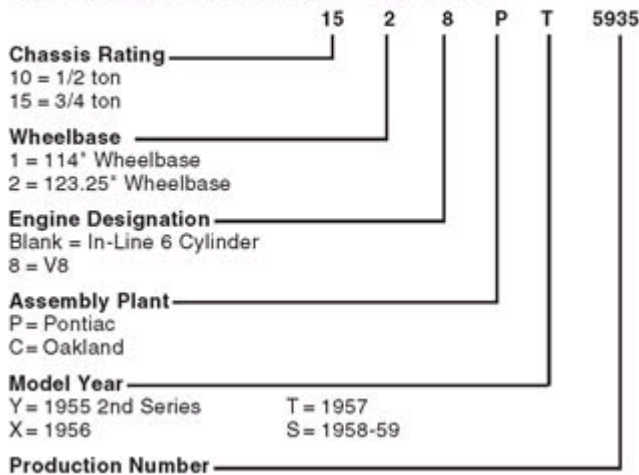

GMC Chassis Identification

Years	Series & Model	Class	Wheelbase	Bed Type
1955-56 2nd Series	100 1766	1/2 Ton	114"	Stepside
	100 1768	1/2 Ton	114"	Suburban Pickup
	100 150 1767	1/2 & 3/4 Ton	123-1/4"	Stepside
1957	100 1766	1/2 Ton	114"	Stepside
	100 1768	1/2 Ton	114"	Suburban Pickup
	100 150 1767	1/2 & 3/4 Ton	123-1/4"	Stepside
	100 150 1799	1/2 & 3/4 Ton	123-1/4"	Stepside
1958	100 1766	1/2 Ton	114"	Stepside
	100 1768	1/2 Ton	114"	Suburban Pickup
	100 1802	1/2 Ton	114"	Fleetside
	100 150 1799	1/2 & 3/4 Ton	123-1/4"	Stepside
	100 150 1804	1/2 & 3/4 Ton	123-1/4"	Fleetside
1959	100 1766	1/2 Ton	114"	Stepside
	100 1802	1/2 Ton	114"	Fleetside
	100 150 1799	1/2 & 3/4 Ton	123-1/4"	Stepside
	100 150 1804	1/2 & 3/4 Ton	123-1/4"	Fleetside

Chevrolet Engine Identification

1947-59 3100, 3200, 3600

1955 2nd Series	3100	3200	3600	235	6 Cylinder	I-6
			3600	265	8 Cylinder	V-8
1956-1957	3100	3200	3600	235	6 Cylinder	I-6
	3100	3200	3600	265	8 Cylinder	V-8
1958-59	3100	3200	3600	235	6 Cylinder	I-6
	3100	3200	3600	283	8 Cylinder	V-8