



## GENERAL INFORMATION

**Ordering Information:** Please make sure you are ordering the correct parts. Verify part numbers upon ordering. On larger orders please fax (905) 404-2302, email at [bill@billstruckshop.com](mailto:bill@billstruckshop.com) / [rob@billstruckshop.com](mailto:rob@billstruckshop.com) / [aaron@billstruckshop.com](mailto:aaron@billstruckshop.com) or call for more information.

**Payment:** We accept VISA, MasterCard, Money Orders, E-Transfers, Personal and Company cheques. Payment plans also available on large restoration. Applicable taxes apply to all sales.

**Shipping:** Ship by your choice of Canpar, UPS, FedEx, Canada Post, or truck carrier on some large items. Most orders can be shipped same day for next business day delivery. Actual shipping charges will be applied. Also, a \$10.00 COD surcharge applies.

**Pricing:** Prices are in Canadian currency. Due to constant fluctuation between the Canadian and U.S. dollar –refer to the prices in the catalogues as a **GUIDE ONLY!** Bill's Truck Shop Limited Ltd., reserves the right to make appropriate changes as necessary. We try to keep prices low by keeping a large inventory on hand at all times. WE never buy parts with YOUR money to sell to YOU so we never pre-charge you for normal stocking items that are out of stock.

**Returns and Guarantees:** If fault is found in the parts or workmanship of item purchased, full money back guarantee or exchange for new item. If fault occurs from installation or misuse, no return will be given. No refunds will be given on electrical components or literature. Call with any questions.

**Back Orders:** No shipping charges will be applied to regular stocked items, unless a manufacturer's back order applies. All back orders cancelled after 60 days.

**Discounts:** Business's may apply for discounts after providing valid business info. Regular customer discounts can be applied depending on volume purchases / monthly specials and payment type. (E.g.: 3% discount on cash sales - on applicable items only) Check our website for monthly specials.

**Parts:** There is an ever increasing supply of reproduction parts, they are not always listed in the catalogues. New items can be viewed on our website, [www.billstruckshop.com](http://www.billstruckshop.com) or call for info.

**Used Parts:** Unlike many other parts suppliers we stock or locate many parts that are not reproduced. We import parts from (California) and bring back trucks, beds, cabs etc. Bill's Truck Shop Limited has made a commitment to supply many new and used parts for your restoration and as a result we are the largest truck part supplier in Canada. NO discounts on used parts. We also will take your used parts in on trade.

### **Hours of Operation:**

Monday to Friday 8:00am to 5:00pm EST

Saturday 9:00am to 3:00pm – Confirm by appointment

Sunday and holidays –Closed

**NOTE: IF DRIVING LONG DISTANCE TO VIEW OUR INVENTORY, PLEASE CALL AHEAD!**

# Cab & Door Weatherstrip

Due to the fluctuation of the Canadian and American dollars call for current prices

# Group 1

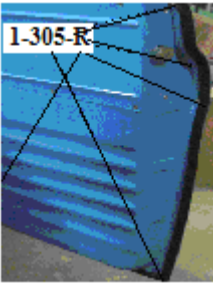
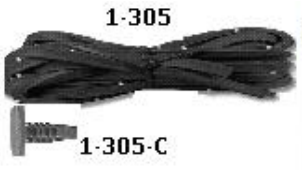
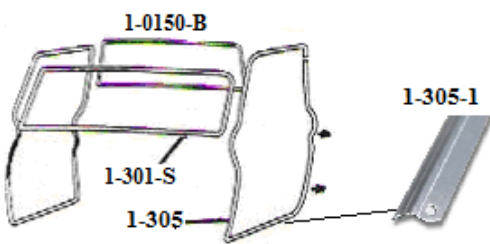

		<u>Year</u>	<u>New</u>	<u>Used</u>
<b>Windshield Weatherstrip</b>				
1-301-S	standard-does not accept trim	55-59	\$74.95	
1-301-D	deluxe - accepts trim	55-59	\$79.95	
<b>Rear Glass Weatherstrip</b>				
1-0150-B	w/ black lock strip	47-66	\$49.95	
1-0150-C	w/ chrome lock strip	47-66	\$59.95	
1-05561-BB	big window w/ black lock	55-66	\$89.95	
1-05561-BC	big window w/ chrome lock strip	55-66	\$89.95	
<b>Chrome Lock Strip per ft 7/16 W x 7/32W</b>				
1-0500	replacement-sold per ft	47-66	\$3.00	
<b>Door Rubber Seals (pair)</b>				
1-305	w/ nylon clips, square corners-may require to relocate pin holes in door or seal	55-59	\$69.95	
1-305-P	panel/suburban rear doors -OE moulded corners w/ steel retainers & nylon clips	55-59	\$269.95	
1-0205-R	universal rear door seals-glue on-pair	36-66	\$35.00	
<b>Door Seal Retainers-# of retainers clips vary from 55-59 &amp; Canadian / US and series size trucks-some also had another @ door front @ rear</b>				
1-305-R	metal clips at curve next to handle @ both lower corners 5 w/ screws/per door	55-59	\$10.95	
1-305-C	nylon clips set of 10	55-59	\$5.25	
<b>Lower Door Seal Retainer (each)</b>				
1-305-1	steel	55-59	\$14.95	
1-305-1SS	stainless steel	55-59	\$22.95	
<b>Retainer Screw Kit (16) -2drs</b>				
1-305-SK		55-59	\$4.95	

## Bill's Truck Shop

Phone (905) 725-3460 / (905) 725-2022 / Fax (905) 404-2302 email: bill@billstruckshop.com

Used

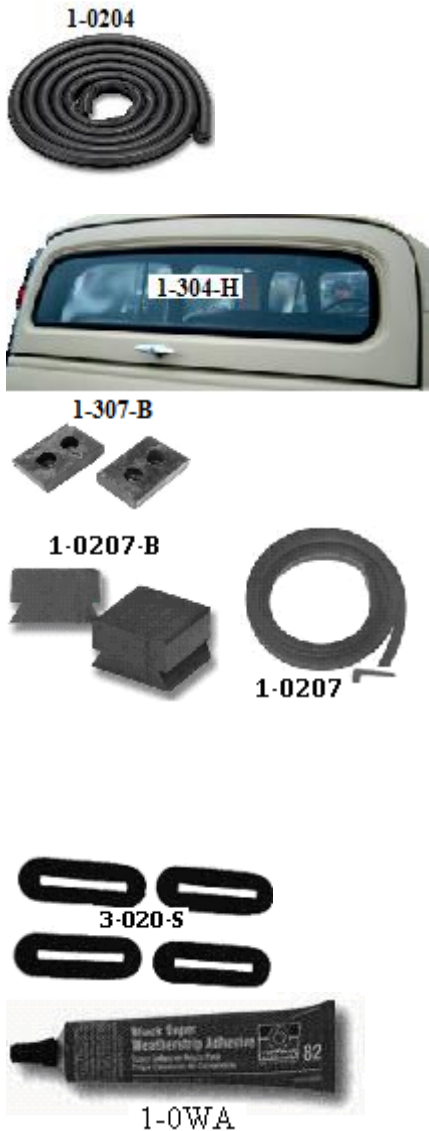

### Panel & Suburban Rear Glass Weather-strip

1-0204 seal for rear glass in doors and upper hatch - universal type----- cut ½ for rear door glass	47-59	\$59.95
1-0204-OE vulcanized 1 pc OE style for rear barn door glass ----- each	47-59	\$56.95
1-304-H in upper hatch w/ clam shell doors-correct OE 1 pc design w/o lock strip	55-59	\$99.00

### Suburban Sliding Window Weatherstrip Kit

seals/channels & weather-stripping (per window)		
11-0411-SL	55-66	\$49.00

### Suburban Stationary Window Weatherstrip Kit

11-0411-ST per window	55-66	\$29.95
-----------------------	-------	---------

### Rear Door Link Arm Bumper-Panel/Suburban

1-0207-B rear barn door upper check arm bumper-USA made	pair	47-59	Inquire
---	------	-------	---------

### Rear Door Bumper-Panel/Suburban

1-307-B rubber wedge bumper located on top & bottom of drivers rear door -screwed into place	pair	55-59	Inquire
--	------	-------	---------

### Rear Valance Seal-panel & suburban

1-0207	47-59	\$26.95
--------	-------	---------

### Door Hinge Seals

3-020-S panel/suburban w/ barn doors-set of 4	36-59	\$36.95
---	-------	---------

### Weather strip Adhesive-black

1-0WA		\$16.95
-------	--	---------

*Bill's Truck Shop*

Phone (905) 725-3460 / (905) 725-2022 / Fax (905) 404-2302 email: bill@billstruckshop.com



# Cab & Door Weatherstrip

Due to the fluctuation of the Canadian and American dollars call for current prices

# Group 2

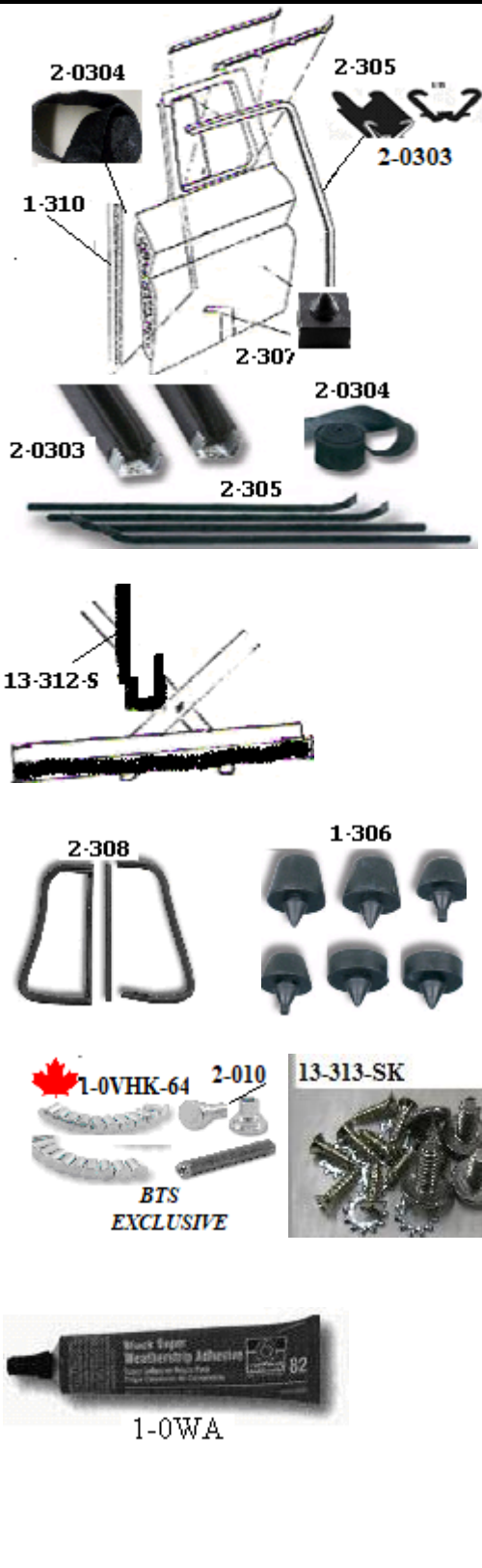

			<u>Year</u>	<u>New</u>	<u>Used</u>
<b>Division Bar Post - with liner /stainless beading</b>					
12-0984	w/framed door glass	each	55-63	\$44.95	
<b>Door Glass Sash Seal</b>					
13-312-S	& secures glass into sash	each	55-59	\$8.95	
<b>Door Glass Channel Runs</b>					
2-0303	felt lined track for framed glass	pair	55-63	\$119.95	
2-0303-1	single lined track		55-63	\$59.95	
<b>Installing one pc glass w/ metal frame</b>					
11-405-1	60-63 Door Glass Channel Run w/ out metal frame on glass	use 1 pr per door	60-63	\$83.95	
<b>Division Bar Relining Channels</b>					
2-0304	felt liner w/glued back	pair	55-63	\$26.95	
<b>Door Window Seals/Scrapers With Clips</b>					
2-305	w/ black beading	set of 4	55-59	\$99.95	
2-305-S	w/ stainless beading	set of 4	55-59	\$99.95	
2-306K-A	used when installing 1 pc glass-w/o vent windows & w/stainless beading	set of 4	55-59	\$109.95	
<b>Door Felt Kit</b>					
2-306K	includes 0303/0304/305	for 2 doors	55-59	\$229.95	
<b>Window Stop Bumper</b>					
2-307		pair	55-59	\$3.95	
<b>Vent Window Rubber kit</b>					
2-308	original design	pair	55-59	\$79.95	
<b>Vent Window rubber install kit-includes rivets//tool</b>					
1-0VHK-55			55-63	\$14.95	
2-010	a pair of vent window pivot rivets			\$6.25	
<b>Glass Setting Tape –rubber- for door and vent glass</b>					
1-0GST	0.062 thick	per foot		\$2.00	
1-0GST-1	thinner 0.047 thick	per foot		\$2.00	
<b>Vent Window Ass install kit-2 doors</b>					
13-313-SK	stainless steel		55-59	\$6.95	
<b>Door Bumper Set</b>					
1-306	2 doors		55-59	\$6.50	
<b>Weather strip Adhesive-black</b>					
1-0WA				\$15.95	

*Bill's Truck Shop*

Phone (905) 725-3460 / (905) 725-2022 / Fax (905) 404-2302 email: bill@billstruckshop.com

# Hood – Fender

Due to the fluctuation of the Canadian and American dollars call for current prices

# Group 3



			<u>Year</u>	<u>New</u>	<u>Used</u>
<b>Hood to Cowl Seal</b>	with retaining clips				
3-303			55-59	\$18.95	
<b>Hood Bumper Set</b>					
3-303-55	10pcs		55-57	\$9.95	
3-303-58	8 pcs		58-59	\$9.95	
<b>Hood Adjuster Bolt</b>	Chev-@rear of hood on cowl & GMC @ rear on cowl & front on hood latch support				
3-320-HA	original used	each	55-59		\$5.00
3-320-HS-S	stainless steel w/ washer ,set nut & bumpers	pr	55-59	\$13.95	
3-320-B	rubber cap for hood adjuster bolt	pair	55-59		
<b>Inner Fender Mounting Grommets</b>	/ inner fender @ cab & rad support				
3-304-G	4 pieces w/ steel sleeves		55-59	\$12.95	
3-304-BK	correct recessed head bolts w/ locked on washers; sleeves & grommets	set of 4	55-59	\$26.95	
<b>Inner Fender Support</b>	@ firewall				
34-355-S	left or right	each	55-59	\$13.95	
34-355-S-SS	stainless steel w/ hdw	pr	55-59	\$28.95	
<b>Braces-Front Fender to Cab</b>					
3-31F		steel/pair	55-59	\$44.95	
3-31F-SS		stainless steel/pair	55-59	\$52.65	
<b>Inner Fender Seal Kit</b>	/U-shaped seal for rear of inner fender at firewall for both sides-included w/ 3-305				
3-304		NEW PRICE!!	55-59	\$11.75	
<b>Outer-Inner Fender Gasket set</b>					
3-305	does both sides-includes 3-304 / 3-306		55-59	\$24.95	
<b>Outer Fender to Cab Seals</b>	included w/ #3-305				
3-306	glue to rear vertical of fender	pair	55-59	\$8.95	
<b>Fender Align Grommets</b>					
3-316	hole used to align inner to outer fender	pair	55-59	\$3.25	

*Bill's Truck Shop*

Phone (905) 725-3460 / (905) 725-2022 / Fax (905) 404-2302 email: bill@billstruckshop.com

# Hood – Fender

Due to the fluctuation of the Canadian and American dollars call for current prices

# Group 3

55-57 hood hinge bolt spacing on firewall is 3 1/8 and 58-59 is 3 5/8 outside dia –top hole is in same location

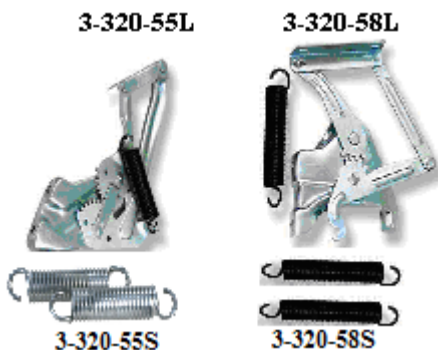

### Hood Hinge

3-320-55L	w/ spring	left	55-57	\$119.95	Inquire
3-320-55R	w/ spring	right	55-57	\$119.95	Inquire
3-320-58L	w/ spring	left	58-59	\$144.95	Inquire
3-320-58R	w/ spring	right	58-59	\$144.95	Inquire

### Hood Hinge bolt kit---note bolt size on cab-can be 5/16 or 3/8

3-320-55BK	3/8 on cab/5/16 on hood	8 bolts-both sides	55-57	\$24.95	
3-320-58K	5/16	10 bolts-both sides	58-59	\$19.95	

### Hood Hinge Springs

3-320-55S	on hinge	pair	55-57	\$44.95	\$10.00
3-320-58S	hooks to fender	pair	58-59	\$44.95	\$10.00

### Hood Latch Assembly

3-320-55C	Chev	55-57	\$114.95	\$45.00
3-320-58C	Chev	58-59	\$114.95	\$45.00
3-320-55G	GMC	55-57		Inquire
3-320-58G	GMC	58-59		Inquire

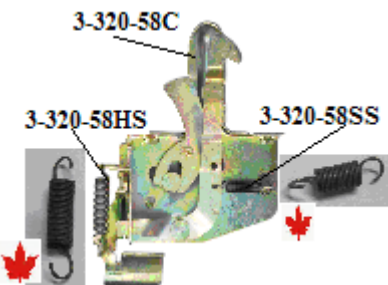

### Hood Latch Handle Spring-

3-320-55HS	return spring	55-57		
3-320-58HS	return spring	58-59	\$6.95	

### Hood Latch Clock Spring

3-320-55CS	55-57	\$19.95
3-320-58CS	58-59	

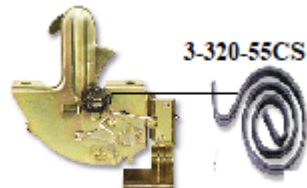

### Hood Latch Safety Arm Spring

3-320-55SS	55-57		
3-320-58SS	return spring	55-59	\$6.95

3-320-55C

### Hood Brace-X bar in hood

3-321-X	55-59	\$30.00
---------	-------	---------



3-302-G

### Cowl Screen Grommet

3-302-G	plug for cowl screen center guide pin in firewall	55-59	\$2.50
---------	---	-------	--------

### Cowl Screen Screw set

3-302-S	stainless steel	5 pcs	55-59	\$1.50
---------	-----------------	-------	-------	--------

## Bill's Truck Shop

Phone (905) 725-3460 / (905) 725-2022 / Fax (905) 404-2302 email: bill@billstruckshop.com

# Instruments

Due to the fluctuation of the Canadian and American dollars call for current prices

# Group 4



4-300-C

4-306-C



4-305-CS



4-307-S

4-307-N



4-307-C



4-305-C



4-304-C



4-0SCS



8-306-5



4-311-C



4-310-C

4-0250-B



19-0469

## Speedometer Assembly

		Year	New	Used
4-300-C	Chev	55-59	\$269.95	\$75.00

**Gauge Decal Kit** Die-cut nylar decals in correct size, shape and colour. Speedometer, odometer, and all gauges/GMC includes tach & clock

4-304-C	Chev	55-59	\$16.95	
---------	------	-------	---------	--

## Instrument Bezel w/ screws

4-305-C	Chev	55-59	\$84.95	\$20.00
---------	------	-------	---------	---------

## Instrument Bezels Screws set

4-305-CS	3 w/ j-nut	Chev	55-59	\$3.95
----------	------------	------	-------	--------

## Instrument Bezel Gaskets Between bezel and glass

4-306-C	Chev	55-59	\$2.25	
---------	------	-------	--------	--

## Instrument Lens

4-307-C	Chev	55-59	\$79.95	
---------	------	-------	---------	--

## Turn Signal Indicator Housings in dash

4-307-S	cardboard housing w/ green lens	pair	55-59	\$9.95
---------	---------------------------------	------	-------	--------

## Speedometer Needle

4-308-N	white	Chev	55-59	\$8.50
---------	-------	------	-------	--------

## Speedometer Cable

4-0SCP	70 " w/ plastic housing	47-72	\$22.95	
4-0SCS	w/ steel casing 70 "	47-72	\$22.95	
4-0SCP-0	w/ plastic casing 75"	47-72	\$33.95	
4-0SCP-1	w/plastic casing 85"	47-72	\$53.95	
4-0SCP-2	w/plastic casing 100"	47-72	\$55.95	

## Speedometer Cable Grommet

8-306-5	into 4-hole large grommet	55-59	\$2.95	
---------	---------------------------	-------	--------	--

## Fuel Gauge

4-310-C	Chev	55-59	\$149.95	
---------	------	-------	----------	--

## Temperature Gauge-please use insulator provided on external side mount plate

4-311-C	electric type /	Chev	56-59	\$124.95
---------	-----------------	------	-------	----------

4-311-CM	mechanical type/	Chev	55-55	\$129.95
----------	------------------	------	-------	----------

## Temp Gauge Bushing

4-0250-B	reducer		\$12.95	
----------	---------	--	---------	--

## Temp Sender w/"T" connector

19-0469	6 or 8 Cyl—1/2 x 14 NPT w/ gauges	Late 55-72	\$36.95	
---------	-----------------------------------	------------	---------	--

19-0469-A	6 or 8 cyl 1/2 x 14NPT w/ gauges-correct resistance for a more accurate OE gauge reading	57-78	\$45.95	
-----------	--	-------	---------	--

*Bill's Truck Shop*

Phone (905) 725-3460 / (905) 725-2022 / Fax (905) 404-2302 email: bill@billstruckshop.com

# Instruments-ID Plates

Due to the fluctuation of the Canadian and American dollars call for current prices

# Group 4



<b>Oil Gauge</b>				
4-312-C	Chev	55-59	\$124.95	
<b>Oil Line kit</b>				
5-0LK	5 ft copper tube w/ fittings	47-72	\$32.95	
68x2	brass block fitting		\$2.75	
<b>Amp Gauge</b>				
4-313-C	Chev	55-59	\$139.00	
<b>Dash Gauge Insulator/warning Label kit</b>				
4-0200-K		47-59	\$1.75	
<b>Gauge Cluster Assembly w/ 58-59 electric temp gauge</b>				
4-315-A	complete w/gauges & speedo Chev only	55-59	\$799.95	
<b>Fuel Gauge Volt Reducer</b>				
4-210-VR	electronic reducer for gauges from 12 to 6 volts	47-55	\$16.00	
<b>Voltage Reducer when changing to 12 volts</b>				
4-210-VRA	for heater motor , radio & accessory	47-55	\$4.50	
<b>Dome Lamp Assembly complete-w/12 V bulb</b>				
4-316-C	chrome housing	55-59	\$43.95	
<b>Dome Lamp Lens</b>				
4-316-L		55-59	\$8.95	
<b>Dome Lamp Bulb</b>				
4-0316-B	12 volt-double contact	55-59	\$2.50	
<b>Cigarette Lighter Assembly</b>				
18-310	w/chrome knob w/o harness	55-59	\$34.95	

**NO WARRANTY ON GAUGES IF  
INSTALLED INCORRECTLY**

*Bill's Truck Shop*

Phone (905) 725-3460 / (905) 725-2022 / Fax (905) 404-2302 email: bill@billstruckshop.com





4-358-C



4-356-C

4-0RIV



**ID Plates**-etched silver tags shows vehicle manufacture, gross weight, horsepower-provision for stamping neck info 1/2 ton

For- AMERICAN BUILT TRUCKS

4-355-C	Chev 5000 LBS	55-55	\$29.95
4-356-C	Chev 5000 LBS	56-57	\$29.95
4-358-C	235- 6 cyl & 283 -8 cyl Chev 5000 LBS	58-59	\$29.95

For-CANADIAN BUILT TRUCKS

4-355-C/C	Chev 5000 LBS	55-55	Inquire
4-356-C/C	Chev 5000 LBS	56-57	Inquire
4-358-C/ Chev	5000 LBS	58-59	Inquire

**Rivets-I.D. Plates**- original plug style

4-0RIV	pair	47-59	\$7.95
--------	------	-------	--------

*Bill's Truck Shop*

Phone (905) 725-3460 / (905) 725-2022 / Fax (905) 404-2302 email: [bill@billstruckshop.com](mailto:bill@billstruckshop.com)



# Instruments

Due to the fluctuation of the Canadian and American dollars call for current prices

# Group 4



For these rebuilt assemblies contact-Rick  
940-300-5235



### Oil Gauge

4-312-G GMC 55-59 \$40.00

### Oil Line kit

5-0LK 5 ft copper tube w/ fittings 47-72 \$32.95  
68x2 brass block fitting \$2.75

### Amp Gauge

4-313-G GMC 55-59 Inquire

### Speedometer

4-300-G GMC 55-59 Inquire

### Fuel Gauge

4-0310-G GMC 55-59 Inquire

### Clock

4-317-G GMC Inquire

**Gauge Decal Kit** Die-cut nylar decals in correct size, shape and colour. Speedometer, odometer, and all gauges/GMC includes tach & clock

4-0304-G GMC 55-59 \$34.95

### Instrument Bezels Screws set

4-305-GS GMC 12 pcs 55-59 \$4.95

### Instrument Bezel Gaskets

4-306-G housing to dash GMC pr 55-59 \$19.95

**INQUIRE ABOUT ANY GMC GAUGE ITEMS**

## Bill's Truck Shop

Phone (905) 725-3460 / (905) 725-2022 / Fax (905) 404-2302 email: bill@billstruckshop.com

# Column-Interior-Dash

Due to the fluctuation of the Canadian and American dollars call for current prices

# Group 5

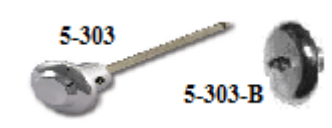
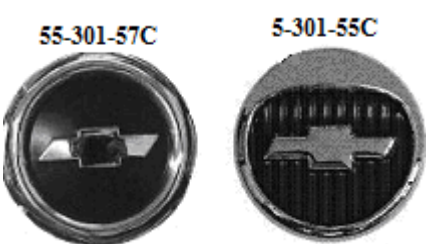

		<u>Year</u>	<u>New</u>	<u>Used</u>
<b>Steering Wheel</b>				
5-0200-54	black	54-56	\$444.95	\$100.00
5-0300-57	black	57-60	\$399.95	\$100.00
<b>Horn Cap – Chevrolet</b>				
5-301-55C	stands 1 ¼" tall	55-56	\$76.95	\$30.00
5-301-57C	stands 2" tall	57-59	\$76.95	\$30.00
5-301-55G	GMC stands 1 ¼" tall	55-56		\$50.00
5-301-57G	GMC stands 2" tall	57-59		\$50.00
<b>Horn Contact &amp; Cap Retainer</b>				
5-0301-3		54-59	\$39.95	
<b>Horn Contact Pin Spring &amp; Bushing</b>				
5-0201-4		47-66	\$12.95	
<b>Steering Wheel Retaining Nut w/ washer</b>				
5-0230-N		47-72	\$1.95	
<b>Spring-Upper Column Bearing</b>				
5-0201-S		47-59	\$9.95	
<b>Light Knob and Rod</b>				
5-303	Chev w/ chrome knob	55-59	\$22.95	\$5.00
5-303-CB	Chev w/ black knob	55-59		\$5.00
5-303-W	GMC w/ white knob	55-59		\$15.00
<b>Light Switch Retainer- Bezel</b>				
5-303-B		55-59	\$16.95	
<b>Wiper Knob</b>				
5-304	chrome w/ 9/32 w/ pentagon hole & set screw	55-59	\$23.95	
5-304-A	black w/pentagon hole w/ set screw /paint white for GMC w/ manual cable control	55-59	\$11.95	
5-304-CW	chrome w/pentagon-hole & original washer button hole w/ set screw	55-59	\$23.95	
<b>Wiper Switch Nut /Bezel</b>				
5-304-B	fits OE & replacement switches	55-59	\$12.95	
<b>Radio Knob &amp; replacement electric wiper switch</b>				
36-309	chrome w/ 3/16 hole & set screw	55-59	\$19.95	
36-309-G	white w/ 3 /16 hole GMC			\$15.00
<b>Turnsignal Lever With Knob approx 46" long</b>				
5-305-1	chrome w/ black knob	55-59	\$21.95	
5-305-G	chrome w/ white knob	55-59		\$10.00

## Bill's Truck Shop

Phone (905) 725-3460 / (905) 725-2022 / Fax (905) 404-2302 email: bill@billstruckshop.com

# Interior-Dash

Due to the fluctuation of the Canadian and American dollars call for current prices

# Group 5

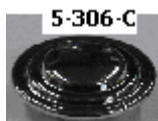

5-0209



5-0209-S



5-307-C



5-308-C

## Support-throttle cable

		<u>Year</u>	<u>New</u>	<u>Used</u>
5-308-S	on firewall	55-59		\$10.00

## Support

5-0209-S	throttle & choke cable @ carb	47-59		\$20.00
----------	-------------------------------	-------	--	---------

## Dash Plug

5-306-C	stainless steel-Chev-GMC	55-59	\$9.95	
---------	--------------------------	-------	--------	--

5-306-G	off white-GMC			
---------	---------------	--	--	--

## Throttle Cable Grommet

5-308-G	½ hole in trans tunnel above accel pivot	55-59	\$2.50	
---------	--	-------	--------	--

## Cable Lock Stop

5-0209			\$1.50	
--------	--	--	--------	--

## Choke Knob With Cable approx. 46" long

5-307-B	w/ black knob	55-59	\$28.95	
---------	---------------	-------	---------	--

5-307-C	w/ chrome knob	55-59	\$29.95	
---------	----------------	-------	---------	--

## Throttle Knob With Cable

5-308-B	w/ black knob	55-59	\$26.95	
---------	---------------	-------	---------	--

5-308-C	w/ chrome knob	55-59	\$28.95	
---------	----------------	-------	---------	--

## Bill's Truck Shop

Phone (905) 725-3460 / (905) 725-2022 / Fax (905) 404-2302 email: bill@billstruckshop.com

# Interior-Dash

Due to the fluctuation of the Canadian and American dollars call for current prices

# Group 5



**Cowl Vent Knob w/ Cable-fits L or R- approx. 63 "**  
does not have OE type support

		Year	New	Used
5-309-B	w/ black knob	55-59	\$34.95	
5-309-C	w/ chrome knob	55-59	\$36.95	

**Cowl Vent Cable Support Screw kit**

5-309-SK	4 screws w/ washers	55-59	\$2.50	
----------	---------------------	-------	--------	--

**Cowl Vent Cable Support –L & R cable on firewall**

5-309-CS	each	55-59	\$9.95	
----------	------	-------	--------	--

**Cowl Vent Cable Grommet @ vent**

5-309-G	pair	55-59	\$4.50	
---------	------	-------	--------	--

**Cowl Vent Valve Seal Set**

5-309-S	replaces flapper seal L & R	pair	55-59	\$6.95
---------	-----------------------------	------	-------	--------

**Cowl Vent Valve HDW kit**

5-309-VK	screws w/ nylon lock nut to assemble 2 halves when installing new seals	20 pcs	55-59	\$2.95
----------	---	--------	-------	--------

**Cowl Vent Cable Retainer @ valve**

5-309-R	w/ screw	each	55-59	\$2.50
---------	----------	------	-------	--------

**Cowl Vent Cover w/ screws**

5-309-LC	mounts vertical	left	55-59	Coming	\$25.00
5-309-RC	mounts horizontal	right	55-59	Coming	\$25.00

**Cowl Vent Cover Seal**

5-309-VS	black sealer/caulking strips	set	55-59	\$7.95
----------	------------------------------	-----	-------	--------

**Cowl Vent Cover screw set-both side**

5-309-CK	7 stainless screws		55-59	\$2.00
----------	--------------------	--	-------	--------

**Cowl Vent Valve**

5-309-VL	left	55-59	\$49.95	
5-309-VR	right	55-59	\$49.95	

**Bill's Truck Shop**

Phone (905) 725-3460 / (905) 725-2022 / Fax (905) 404-2302 email: bill@billstruckshop.com

# Interior-Dash

Due to the fluctuation of the Canadian and American dollars call for current prices

# Group 5



5-0211-F

5-311-1

5-313-G



5-313-GH

5-0215-S



5-315

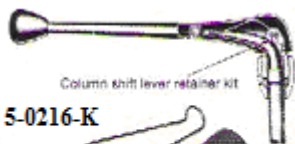

Column shift lever retainer kit

5-0216-K



5-019

5-0220-P

5-0230-N

5-317-G



3-0440-G



## Ashtray

			<u>Year</u>	<u>New</u>	<u>Used</u>
5-313-C	Chev		55-59		\$20.00
5-313-G	GMC		55-59		\$40.00

## Ashtray Handle

5-313-GH	chrome handle/good used	GMC	55-59		\$25.00
----------	-------------------------	-----	-------	--	---------

## Gearshift Knob

5-311-1	3 speed & aut black		55-59		\$12.95
5-0211-F	floor shift-black-can also be used on NAPCO shifter---	no markings	40-59		\$16.95

## Shift Bracket

5-315			55-59	\$39.95	\$15.00
-------	--	--	-------	---------	---------

## Column Shift Bracket Screws

5-0215-S	1/4 x 28- 3/8 fine thread-stainless steel --we now include external countersunk washer to help prevent screw from coming loose	pair	47-59		\$6.95
----------	--	------	-------	--	--------

## Column Shift Lever Kit includes pins/springs & bushings

5-0216-K			47-59		\$34.95
----------	--	--	-------	--	---------

## Shift Rod Grommet

3-0440-G	with metal lining	each	47-66		\$6.75
5-317-G	set of 4-rubber		55-59		\$6.50

## Shifter Boot at shift box

5-019			47-59		\$4.95
-------	--	--	-------	--	--------

## Shifter Box Plug

5-0220-P	stainless cap on 3 speed shift box		47-55		\$1.50
----------	------------------------------------	--	-------	--	--------

## Steering Column Shifter Lever

5-323	3 speed or Aut		55-59		\$15.00
-------	----------------	--	-------	--	---------

## Steering Column Shifter Tube

5-323-T	2 pc shaft w/ joiner		55-59		\$30.00
---------	----------------------	--	-------	--	---------

## Steering Wheel Retaining Nut w/ washer

5-0230-N			47-72		\$1.95
----------	--	--	-------	--	--------

## Bill's Truck Shop

Phone (905) 725-3460 / (905) 725-2022 / Fax (905) 404-2302 email: bill@billstruckshop.com



# Interior-Dash

Due to the fluctuation of the Canadian and American dollars call for current prices

# Group 5

Year      New      Used



### Steering Column Support

5-316-S in quire for 1/2 -3/4 and 2 ton up have a taller support stand

55-59

\$40.00



### Steering Column mount hdw kit

5-316-HK washers, spacers, bolts

55-50

\$19.95



### Steering Column Clamp Bushing

5-0316

55-59

\$3.50



### Steering Column Support Pads-

5-0216-P between column support & dash

pair

54-59

\$3.25

*Bill's Truck Shop*

Phone (905) 725-3460 / (905) 725-2022 / Fax (905) 404-2302 email: bill@billstruckshop.com



# Firewall And Floor

Due to the fluctuation of the Canadian and American dollars call for current prices

# Group 7

			<u>Year</u>	<u>New</u>	<u>Used</u>
					
7-0301-55	7-0201-2	7-301-58			
<b>Accelerator Pedal</b>					
7-0301-55			53-57	\$26.95	
7-301-58			58-59	\$26.95	
<b>Accelerator Pedal Pivot Pin and Clip</b>					
7-0201-2			47-57	\$5.95	
<b>Accelerator Pedal Shaft Floor Seal</b>					
7-0201-4			47-59	\$4.95	
					
7-0517	7-0517-S				
<b>Accelerator Rod</b>					
7-0517	Accelerator Rod - pedal to cab- 6 or 8 cyl 15" long	w/ sivel & cotter pins	55-70	\$34.95	
7-0517—S	swivel w/ hdw		55-70	\$5.95	
					
7-0201-4	7-303				
<b>Brake &amp; Clutch Hardware</b>					
7-			55-59		Inquire
<b>Brake &amp; Clutch Pedal Pad</b>					
7-303-1		each	55-59	\$5.95	
<b>Brake &amp; Clutch Floor Shaft Seals</b>					
7-303			55-59	\$5.95	
					
7-303-1	7-003-S				
<b>Clutch-Brake Arm Stop Bumper</b>					
7-003-S	55-59 clutch only	each	47-59	\$2.95	
<b>Brake &amp; Clutch Pedal Bushings (pair)</b>					
7-303-B	brass oversize to repair worn shaft-machine as nec		55-59	\$22.95	
<b>Parking Brake Assembly</b>					
	Original dash mount		55-59		Inquire
<b>Parking Brake Rod Seal -</b>					
7-304-1	at firewall		55-59	\$2.95	
7-304-R	seal retainer w/ screws-coming soon in paintable steel @ brushed stainless steel		55-59	\$10.00	
7-304-RS	brushed stainless steel		55-59		
					
7-304-R	7-304-1				
<b>Park Brake Return Spring</b>					
37-0310-R	spring w/ rod-locates @ center frame support- and 66 early production 9" long		55-65	\$11.95	
37-310-E1	6 ft short bed extension		55-59	\$4.75	
37-310-E2	8 ft extension		55-59		
					
9" long 37-0310-R	38-0219-HS				
37-310-E1					
<b>Park Brake Handle Spring w/hand brake</b>					
38-0219-HS	with brake @ trans		29-59	\$13.95	







*Bill's Truck Shop*

Phone (905) 725-3460 / (905) 725-2022 / Fax (905) 404-2302 email: bill@billstruckshop.com

# Firewall And Floor

Due to the fluctuation of the Canadian and American dollars call for current prices

# Group 7

		<u>Year</u>	<u>New</u>	<u>Used</u>			
<b>Requires closing shift tube hole w/floor shift</b>							
<b>Steering Column Floor Retainer&amp; Seal</b>							
		7-308-4	column shift	includes screws	55-59	\$17.95	
<b>Steering Column Floor Seal only</b>							
		7-308-S			55-59	\$4.95	
<b>Starter Pedal Assembly</b>							
		7-310			55-59		Inquire
<b>Starter Pedal Pad</b>							
		7-0315-P	w /foot pedal start-rubber		47-59	\$6.95	
<b>Starter Bellows</b>							
		7-0315			47-59	\$10.95	
<b>Starter Linkage Floor Plug-steel plug on firewall</b>							
		7-315-P	w/ key start	starter	55-59		\$10.00
		7-0315-P					
<b>Clutch Head Driver Set</b>							
		5-0CHSD-4	4 x screw drivers		47-61	\$33.95	
		5-0CHS-4	4 x 3/8 drive sockets		47-61	\$34.95	

## Bill's Truck Shop

Phone (905) 725-3460 / (905) 725-2022 / Fax (905) 404-2302 email: bill@billstruckshop.com

# Firewall And Floor

Due to the fluctuation of the Canadian and American dollars call for current prices

# Group 8



	<u>Year</u>	<u>New</u>
<b>Floor Shift Sponge Seal</b> 4 speed		
6-0FSS	47-66	\$7.95
<b>Floor Shift Boot</b>		
8-0SB-C w/ Chev emblem	47-66	\$28.95
8-0SB-B blank	47-66	NLA
<b>Floor Shift Boot Retainer</b>		
6-0BR 14G brushed stainless steel w/screws	47-66	\$29.95
<b>Hand Brake Sponge Seal</b>		
8-0204-S floor mounted	37-59	\$5.50
<b>Hand Brake Boot</b>		
8-0204-B	47-59	\$18.95
<b>Hand Brake Boot Retainer</b>		
8-0204-R 14G brushed stainless steel w/screws	47-59	\$15.95
<b>Master Cylinder Access Plug</b>		
8-0325	47-59	\$10.95
<b>Main Wire Harness Firewall Grommet</b>		
8-0105 on right firewall @ battery tray-55-59	47-59	\$3.95
<b>Starter Wire Firewall Grommet</b>		
8-306-2 upper firewall on pass side w/ 7/8 hole	55-59	\$3.25
<b>Four Hole Firewall Grommet-check hole size</b>		
8-0206-4 choke/ speedo 1 1/8 " hole at upper left firewall usually <b>2 required</b>	50-59	\$3.95
8-306-5 vac/speedo/oil 1 1/4 hole <b>check hole size for correct application-also GMC hole size</b>	55-59	\$2.25
<b>Firewall Grommet kit</b>		
8-306-K 1 x 8-0105/8-0206-4/8-306-5/8-306-2	55-59	\$13.95
<b>Transmission Floor Cover</b>		
8-308 3 speed column Shift	55-59	\$129.95
8-308-1 4 speed floor shift	55-59	\$99.95
<b>Transmission Floor Cover Gasket</b>		
8-308-2	55-59	\$14.95
<b>Transmission Floor Cover Screw Set</b>		
8-308-3 9pc	55-59	\$4.95
<b>Battery Hold Down Hardware</b>		
8-309-4 2 bolts and wing nuts and washer	55-59	\$10.95
<b>Battery Box</b>		
8-309-55	55-57	\$72.95
8-309-58	58-59	\$79.95

*Bill's Truck Shop*

Phone (905) 725-3460 / (905) 725-2022 / Fax (905) 404-2302 email: bill@billstruckshop.com

		<u>Year</u>	<u>New</u>	<u>Used</u>
 8-309-55R	<b>Battery Retainer</b>			
	8-309-55R      10.5" long x 7 " wide	55-57	\$26.95	
 20-0425-R	20-0425-R	58-66	\$19.95	
	<b>Battery Tray Bolt Kit</b>			
 8-0462 8-0463	8-309-K OE style washer head bolts/ cadmium plated	55-59	\$6.25	
	<b>Ground Strap -braided as original</b>			
 8-0462 8-0463	8-0462      battery to body 11 "	47-59	\$37.95	
	8-0463      engine to body 12"	47-59	\$34.95	
 8-0462 8-0463	<b>Battery to Starter # 4 gauge w/12 volt system</b>			
	8-3464-C      6 cyl 30 " long cloth covered	55-59	\$39.95	
	8-3464-B      6 cyl 30 " long vinal covered	55-59	\$24.95	
	8-3465-C      8 cyl 52 " long cloth covered	55-59	\$49.95	
 8-3464 8-0880	8-3465-B      8 cyl 52 " long vinal covered	55-59	\$32.95	
	<b>Battery Cable End-replacement clamp style</b>			
 8-3464 8-0880	8-0880      battery cable end		\$3.95	
	<b>Battery Adaptors-side post cable to top post battery</b>			
 8-0760-R 8-0760-B 8-0878	8-0878      pair		\$9.95	
	<b>Battery Cable Cover-top post/slip on</b>			
 8-0760-R 8-0760-B 8-0878	8-0760-R      red/positive		\$2.95	
	8-0760-B      black/neg		\$2.95	

*Send us a picture of you truck with some text and we will post it in the gallery on our web site*

# Glove Box Door/Dash

Due to the fluctuation of the Canadian and American dollars call for current prices

# Group 9

			<u>Year</u>	<u>New</u>	<u>Used</u>
	<b>9-301-C</b>				
<b>Glove Box Door w/hinge</b>					
	9-301-C	Chev	55-59	\$139.95	\$50.00
	9-301-G	GMC	55-59		\$75.00
	<b>9-301-HC</b>				
<b>Glove Box Hinge</b>					
	9-301-HC	hinge w/o arms Chev	55-59	\$34.95	
	9-301-HG	hinge w/ arms -GMC	55-59		\$30.00
	<b>9-301-A</b>				
<b>Glove Box Hinge &amp; Arm Screw kit</b>					
	9-301-SK	10 screws w/ washers	55-59	\$4.95	
	<b>9-301-SK</b>				
<b>Glove Box Arms</b>					
	9-301-A	pair	55-59	\$34.95	
<b>Glove Box Liner</b>					
	9-302-C	Chev	55-59	\$24.95	
	9-302-G	GMC	55-59	\$24.95	
	<b>9-302-C</b>				
	<b>9-301-5</b>				
<b>Glove Box Mounting Screws</b>					
	9-301-5	set of 7	55-59	\$6.95	
<b>Glove Box Door Bumpers</b>					
	5-0GBB	pair	47-72	\$2.50	
<b>Glove Box Lock &amp; Key</b>					
	5-0221	w/o key	54-72	\$26.95	
	5-0222	Original Style w 2 keys	54-72	\$43.95	\$15.00
	<b>5-0222</b>				
	<b>5-0223</b>				
	<b>5-0224</b>				
<b>Glove Box Lock Gasket</b>					
	5-0223		54-72	\$1.50	
<b>Glove Box Lock Retainer Bracket &amp; Screw</b>					
	5-0224		54-72	\$3.95	\$1.00
<b>Glove Box Lock Striker</b>					
	9-0201-13		54-59	\$8.95	
	<b>9-0201-13</b>				
	<b>5-0GBB</b>				
<b>Glove Box Light Kit</b>					
	5-0GBL		54-72	\$19.95	
	<b>5-0GBL</b>				

*Bill's Truck Shop*

Phone (905) 725-3460 / (905) 725-2022 / Fax (905) 404-2302 email: [bill@billstruckshop.com](mailto:bill@billstruckshop.com)



# Interior Parts

Due to the fluctuation of the Canadian and American dollars call for current prices

# Group 10



### Headliner w/ original style pattern

		Year	New	Used
10-305-B	black -plastic	55-59	\$69.95	
10-305-W	white	55-59	\$69.95	
10-305-R	red	55-59	Inquire	

### Headliner Retainer Seal

10-306-B	black rubber seal	55-59	\$42.95	
10-306-W	off-white rubber seal -because the white yellows after a short period of time we no longer carry them -we are trying to locate a better product	55-59	NLA	

### Headliner Insulation

10-305-I		55-59	\$32.95	
----------	--	-------	---------	--

**This original replacement water resistant pressboard headliner is covered with Madrid Grain Vinyl with dielectric heated sealed seams installed w/ Velcro ( provided ) and original rubber seal ( add to order )**

10-305-2295	black	55-59	\$194.95	
10-305-4545	maroon	55-59	\$194.95	
10-305-0511	red	55-59	\$194.95	
10-305-4489	navy blue	55-59	\$194.95	
10-305-2309	medium blue	55-59	\$194.95	
10-305-3608	light blue	55-59	\$194.95	
10-305-90022	palomino	55-59	\$194.95	
10-305-4533	dark saddle—special order	55-59	\$194.95	
10-305-6758	medium grey	55-59	\$194.95	
10-305-0702	charcoal	55-59	\$194.95	
10-305-4544	saddle	55-59	\$194.95	

### Armrest w-hardware

10-0204-BK	black	55-66	\$64.95	
10-0204-BR	brown	55-66	\$64.95	
10-0204-G	grey	55-66	\$64.95	
10-0204-R	red w/ beige base	55-66	\$69.95	

### Armrest Screw

9-0773-AS	¼ x 20 x 1 ¼ philips screw	pair	47-72	\$2.00
-----------	----------------------------	------	-------	--------

### Armrest Nut

9-0773-AN	cage nut	pair	47-72	\$4.95
-----------	----------	------	-------	--------

## Bill's Truck Shop

Phone (905) 725-3460 / (905) 725-2022 / Fax (905) 404-2302 email: bill@billstruckshop.com





When ordering seat belts there are many issues that will have to be addressed –eg-buckets-bench-height of seat-mount location etc / note- 3 point system lock buckle must be on side of person

Some applications may require an extender-see below for 6" metal ext or 12" belt extension

### Seat Belts /lap style-w/ hdw.-per person

Push button STD ( coloured) 22"long w/female end & 38" long w/ male end // or lift lever ( chrome) type DLX 22" long male end & 38" long female end- 60 " DLX 42" long male end & 30" long female end-72"

SB-N2PB	black w/ std buckle	\$74.95
SB-N2PR	red w/ std buckle	\$74.95
SB-N2PG	grey w/ std buckle	\$74.95
SB-N2PT	tan w/ std buckle	\$74.95
SB-N2PN	navy blue w std buckle	\$74.95
SB-N2PM	maroon w/ std buckle	\$74.95
SB-N2LB	black w/chrome buckle	\$89.95
SB-N2LB-72	black w/chrome buckle 72" long	\$89.95
SB-N2LG	grey w/ chrome buckle	\$89.95
SB-N2LN	navy blue w/chrome buckle	\$89.95
SB-N2LN-72	blue w/chrome buckle 72" long	\$89.95
SB-N2LR	red w/ chrome buckle	\$89.95
SB-N2LTAN	tan w/ chrome buckle	\$89.95

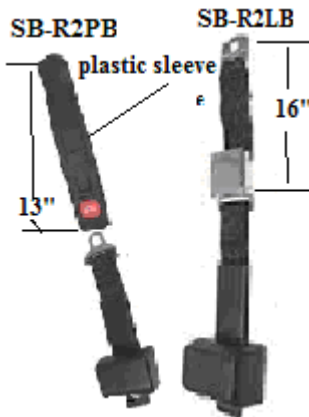

**2-point retractable** w/ hdw-- 13 " female w/ plastic sleeve/16" w/ loose end

Push button STD or lift lever ( chrome) type DLX

SB-R2PB	black w/ std buckle	each	\$126.95
SB-R2PR	red w/ std buckle	each	\$126.95
SB-R2PG	grey w/ std buckle	each	\$126.95
SB-R2PT	tan w/ std buckle	each	\$126.95
SB-R2PM	maroon w/ std buckle	each	\$126.95
SB-R2PN	blue w/ std buckle	each	\$126.95
SB-R2LB	black w/ dlx	each	\$126.95
SB-R2LR	red w/ dlx	each	\$126.95
SB-R2LT	tan w/ dlx	each	\$126.95
SB-R2LG	gray w/ dlx	each	\$126.95

Year      New      Used

When ordering seat belts there are many issues that will have to be addressed –eg-buckets-bench-height of seat-mount location etc / note- 3 point system lock buckle must be on side of person

Some applications may require an extender-see below for 6” metal ext or 12” belt extension



SB-R3LB

**3-point retractable** w /hdw and chrome lift latch ( air plane style) approx 24” inner female

SB-R3LB      black w/ chrome buckle      each      \$249.95

SB-R3LDB      dark blue w/chrome buckle      each      \$234.95

**3-point retractable** w /hdw

Push button STD ( coloured) or lift lever ( chrome) type DLX

SB-R3PB      black w/ std buckle      each      \$209.95

SB-R3PG      gray w/ std buckle      each      \$209.95

SB-R3PM      maroon w/ std buckle      each      \$209.95

SB-R3PT      tan w/ standard buckle      each      \$209.95

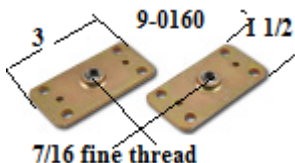

7/16 fine thread



BTS  
EXCLUSIVE



FAB-1008-1

**Anchor Plates**

9-0160      w/ shoulder belt -7/16 fine thread / pr      47-66      \$29.95

**Belt Extension w/ hdw**

SB-12XBK      black      \$21.95

SB-12XBL      navy blue      \$21.95

SB-12XR      red      \$21.95

SB-12XT      tan      Inquire

SB-12XG      gray      \$21.95



SB-12XBK

**Metal Extension**

FAB-1008-1      1 “ 90 deg “ ext      \$9.95

FAB-1001-3      8 “ ext w/3 holes @ 2 ½ apart- cut to desired length as required      \$11.95

**Seat Belt Retractors-pr** a reproduction of an OE option- for non retractable seat belts-prevents belt from falling out vehicle doors

9-0SBR      pair      \$34.95



9-0SBR

# Interior Parts

Due to the fluctuation of the Canadian and American dollars call for current prices

# Group 11

11-0205-BK



11-0205-C



include w/ new visors

11-3275-90022



includes screws w/ new

11-205-R



11-0205-2

## Sun Visors includes end clips each

11-0205-BK	black	47-59	\$49.95
11-0205-BR	brown	47-59	\$49.95
11-0205-G	grey	47-59	\$49.95
11-0205-M	maroon	47-59	\$49.95
11-0205-R	red	47-59	\$49.95

## Special order --madrid grain vinyl--sold as a pr

11-3275-2295	black	55-59	\$179.95
11-3275-4545	maroon	55-59	\$179.95
11-3275-0511	red	55-59	\$179.95
11-3275-4489	navy blue	55-59	\$179.95
11-3275-3608	light blue	55-59	\$179.95
11-3275-2309	medium blue	55-59	\$179.95
11-3275-90022	palomino	55-59	\$179.95
11-3275-4533	dark saddle	55-59	\$179.95
11-3275-6758	medium grey	55-59	\$179.95
11-3275-0702	charcoal	55-59	\$179.95

## Sun Visor Bracket - chrome with screws

11-305-L		55-59	\$29.95
11-305-R		55-59	\$29.95

## Sun Visor Bracket Screw kit

11-0205-2	3 pcs	47-59	\$0.95
-----------	-------	-------	--------

## Sun Visor End Clips

Stainless-steel clips for uncovered visor.

11-0205-C	pair	47-66	\$3.50
-----------	------	-------	--------

## Bill's Truck Shop

Phone (905) 725-3460 / (905) 725-2022 / Fax (905) 404-2302 email: bill@billstruckshop.com

*inquire about other colour combinations & vinyl-cloth*

**SEAT COVERS**

**Cover** Heavy Duty vinyl similar to original colour and grain w/stitched foam backing –madrid vinyl *inquire about other colour combinations*



11-207



11-306-BKV-P	black pleated vinyl	55-59	\$495.95
11-306-BKV	black non pleated vinyl	55-59	\$449.95
11-306-DSV	dark saddle non pleated vinal	55-59	\$449.95
11-306-LBV-P	light blue w/ pleats	55-59	\$495.95
11-306-BK2	black scottsdale velour inserts w/o pleats w/ black vinyl trim	55.59	\$499.95

**Piping can be added to edge in all colours- inquire-there is \$125.00 extra charge**

**11-0PIP** \$125.00

**ECONOMY SEAT COVER**

<b>Seat Cover</b>	replacement- vinyl cover only		
11-307-BV	black vinyl	55-59	\$269.95
11-307-BNV	brown vinyl	55-59	\$269.95
11-307-GRV	gray vinyl	55-59	\$269.95

**Seat Upholstery Installation Kit**

11-307-K	includes burlap and cotton padding-used when installing all venal seat cover	55-59	\$24.95
11-307-B	burlap only 12 ft section for both halves	55-59	\$16.95

**Seat Cover-CAMEO style 2 tone velour/cloth/vinyl**

11-306-BK2	black Scottsdale cloth w/ black madrid vinyl subs w/ out pleats	55-59	\$544.95
11-306-BK2-P	black Scottsdale (encore) velour w/ black madrid vinyl subs w/ pleats	55-59	\$544.95
11-306-RB2	royal blue velour w/ white madrid vinal subs w/o pleats	55-59	\$544.95

Many other colour combinations available  
Call for sample pictures of material and seats



**Seat to Frame Clip kit**

11-0SC	70 pieces	39-59	\$18.50
--------	-----------	-------	---------

# Interior Parts

Due to the fluctuation of the Canadian and American dollars call for current prices

# Group 11

			<u>Year</u>	<u>New</u>	<u>Used</u>
	11-0307-H				
<b>Seat Spring Tie Clip</b>					
	11-0209	secures spring together	set of 3	47-72	\$1.95
<b>Seat Frame Filler Plug</b>					
	11-308	rubber seat frame end caps	-pr	55-59	\$25.95
<b>Seat Track</b>					
	11-308-T	seat track w/ adj rod	pr	55-59	\$125.00
<b>Seat Track Adj Rod</b>					
	11-308-R	original steel rod between track		55-59	\$10.00
<b>Seat Adjuster cable kit</b>					
	8-0070	Cable-seat adjust kit w/ adjustable turnbuckle		50-87	\$12.95
<b>Seat Rod Spring</b>					
	11-308-RS	secures rod to seat base		55-59	
<b>Seat Adjust Handle</b>					
	11-0307-H	stainless steel w/ hdw		55-66	\$38.00
<b>Seat Frame Assembly</b>					
	11-308-F			55-59	\$200.00
<b>Seat Return Spring</b>					
	11-0307-S			55-80	\$11.95
<b>Seat Cushion Spring-lower</b>					
	11-308-CS	vertical coil spring		55-59	\$5.00
<b>Seat Arm Pivot Bolt</b>					
	11-308-PB	w/ shim and spacer	each	55-59	\$3.00
<b>Springs NEW</b>					
	11-0207-S	seat base coil tension spring-set of 4		47-59	\$14.95
		Secures the standing springs			

## Bill's Truck Shop

Phone (905) 725-3460 / (905) 725-2022 / Fax (905) 404-2302 email: bill@billstruckshop.com



# Interior Parts

Due to the fluctuation of the Canadian and American dollars call for current prices

# Group 11

## Carpets with Underlay

Cut to fit with edges sewn & underlay- inquire about many other colours-**LOOP PILE**- also available in **NYLON CUP PILE**

Also note w/ high hump floor-add HH ( 4 speed )

All carpet are extra long for no gas tank

Can also be ordered w/o holes for pedals -- NH

		Year	New	Used
11-310-B	black	55-59	\$269.95	
11-310-G	gun metal grey	55-59	\$269.95	
11-310-R	red	55-59	\$269.95	
11-310-B-NH	w/out pedal holes black	55-59	\$269.95	

## CARPET- 2 yards – call for other colours

8-000Y-01	black-loop pile approx 80 “ x 72”		\$144.95	
10782	Dimmer switch grommet-(included w/ new carpet)		\$8.95	

**Sill Plates aluminum-bright polished machined w/ screws-secures carpet/rubber mat to rocker step edge---see picture on bottom of page**

11-3076	front left and right	pair	55-59	\$278.95
11-3077	rear	each	55-59	\$64.95

## Rubber Floor mat

11-311-3	automatic or 3 speed std	black	55-59	\$239.95
11-311-4	4 speed w/ HH	<b>NEW VINYL</b> includes felt backing-w/o holes-may require some edge trimming	55-59	\$269.95

## Felt Mat

11-312-FM	helps reduce noise & heat		55-59	\$44.95
-----------	---------------------------	--	-------	---------

## Sound Deadener

11-312-SD	Floor Deadener kit-Die-cut asphalt based material w/ foam liner		55-59	\$109.95
-----------	---	--	-------	----------

11-0HSD Universal heat & sound insulation – 3/8 single sided foil backed w/ jute liner 4 x 6

## Inner Firewall Cover

Pre-cut rubber and felt laminated on one sheet.

11-313			55-59	\$79.95
--------	--	--	-------	---------

## Inner Firewall Cover Retainers

11-313-R	may require hole enlargement--	plastic (9)	55-59	\$11.95
11-0213-S	OE metal type-each		47-59	\$6.50

## Bill's Truck Shop

Phone (905) 725-3460 / (905) 725-2022 / Fax (905) 404-2302 email: bill@billstruckshop.com

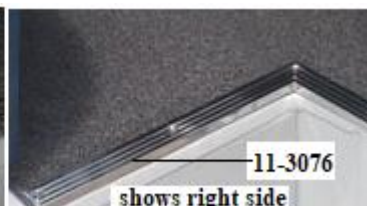
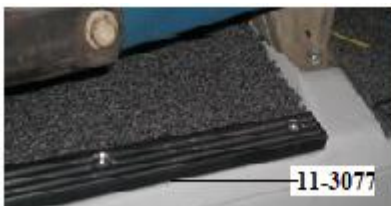



# Door Parts

Due to the fluctuation of the Canadian and American dollars call for current prices

# Group 12



			Year	New	Used
<b>Inside Door Handle</b> (each) with a set screw					
12-01DH	chrome		47-66	\$26.95	
<b>Inside Window Handle</b> with set screw					
12-01WH	chrome black knob		47-66	\$24.95	
<b>Inside Handle Gasket Set</b>					
12-01HG	sponge seals & fibre washers		47-66	\$6.95	
<b>Interior Handle Escutcheon</b>					
12-01HE	grey	each	47-87	\$2.95	
<b>Inside Handle Set Screw for OE handles only- some applications used a 2<sup>nd</sup> lock set screw above</b>					
12-0204	1/4 x 20 hex head	each	47-66	\$0.60	
12-0204-S	set screw 1/4-20x3/8		47-66	\$0.60	
<b>Outside Door Handles</b> (with gaskets & screws)					
12-0107	w/out right side button / lock	pair	52-59	\$94.95	
12-0107-1	for rear on panel/suburban door w/o button or lock		52-59	\$49.95	
<b>Door Handle (outer )screw kit- 8 pcs</b>					
12-0025-HK			52-72	\$3.50	
<b>Outside Door Lock With Key</b> (2 keys)					
12-305-1	front doors and rear door on panel /suburban single door lock w/ 1 7/8 shaft length		55-59	\$64.95	
12-305-2	2 door locks- can be used on ft & rear door		55-59	\$129.95	
12-305-3	ignition cylinder/glove box & 2 door locks		55-59	\$164.95	
<b>Outside Handle Gasket Set</b>					
12-0205			52-66	\$2.95	
<b>Outside Handle Scratch Shields Chrome Plated</b>					
12-0185		pair	52-59	\$38.95	
<b>Vent Handle Kit</b> Chrome plated with pin and washer					
12-306-L		left	55-59	\$22.95	
12-306-R		right	55-59	\$22.95	
<b>Vent Handle Roll Pin</b>					
12-0996		each	51-72	\$0.30	

*Bill's Truck Shop*

Phone (905) 725-3460 / (905) 725-2022 / Fax (905) 404-2302 email: bill@billstruckshop.com

# Door Parts

Due to the fluctuation of the Canadian and American dollars call for current prices

# Group 12

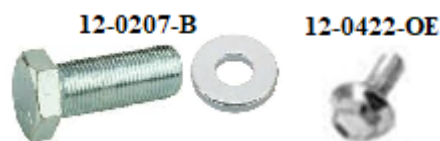
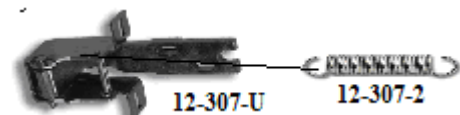

## Door Hinges

			Year	New	Used
12-307-L	fits L or R Lower	each	55-59	\$99.95	
12-307-U	fits L or R upper (w/ door check)	each	55-59	\$99.95	

## Door Hinge Rebuilt Kit

12-0HPK	2 (11/32) pins / 4 (13/32) OS brass bushing		47-87	\$12.95	
---------	---	--	-------	---------	--

## Door Hinge Check Spring

12-307-2	on upper door hinge	each	55-59	\$2.50	
----------	---------------------	------	-------	--------	--

## Door Hinge Cage Nut **new item**

12-0307-CN	3/8 fine thread rectangular nut	each	55-59	\$17.95	
------------	---------------------------------	------	-------	---------	--

## Door Hinge Bolts **OE is all fine thread-thicker part of hinge requires the longer bolt**

12-0422-OE	OE style w/ floating washer head	3/8 fine-1" long	each	55-59	\$2.95
12-0207-B	replacement style	3/8 x 1 fine thread w/ washer	each	55-59	\$1.00

## Lower Door Drain Plug

12-310	set of 4		55-59	\$14.95	
--------	----------	--	-------	---------	--

## Lower Hinge Access Panels –single available

ONLY while supplies last 12-307-LP & RP

12-307-PR	L m& R pair		55-59	\$36.95	
12-307-S	panel screws stainless steel	8pcs	55-59	\$2.95	

Bill's Truck Shop

Phone (905) 725-3460 / (905) 725-2022 / Fax (905) 404-2302 email: bill@billstruckshop.com



The easy latch kit is a vehicle specific bolt-on, bear jaw rotary claw latch kit. This kit features contoured jam plates to match the features of your vehicles doors. These are in no way a universal application. The bear jaw rotary claw latches are each designed to work with the exterior handles, interior handles, and the exterior door lock cylinders of the specified vehicles. Each piece of the bear jaw latches are zinc plated to fight corrosion. The internal claws are case hardened and black oxide coated. Each kit comes with everything you need for two doors. Latch plates, vehicle specific bear jaw rotary claw latches, templates, hardware, detailed instructions, striker plates, and even stainless steel striker bolts. The Easy Latch kit will have your doors opening and closing smoothly and safely. All of the kits are designed, manufactured, and assembled here in the US

Most of our Altman Easy Latch Kits jam plates are available in your choice of paint to match steel or mirror polished stainless steel.

**Altman Easy Latch kit**

12-308-A

<u>Year</u>	<u>New</u>	<u>Used</u>
55-59	\$519.95	



**PANEL & SURBURBAN REAR DOORS/HATCH**

**Rear door hinges up/lower—left/right**

55-59

Inquire

12-325-???

**Bolt kit-rear door hinge 18 pc per hinge**

12-325-BK









55-59

\$6.75

# Door Parts

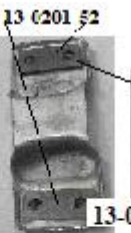
Due to the fluctuation of the Canadian and American dollars call for current prices

# Group 12

			<u>Year</u>	<u>New</u>	<u>Used</u>
<b>12-308-L</b>					
<b>12-0208-3</b>					
<b>12-0DLC</b>					
<b>Door Latch-----door latch &amp; strikers CANNOT be used to adjust door fitment</b>					
12-308-L	Left		55-59	\$69.95	
12-308-R	Right		55-59	\$69.95	
12-308-1R	panel / suburban rear door		55-59	\$69.95	
<b>Door Latch Screw Kit</b>					
12-0208-3	3 pcs per side		52-59	\$2.50	
<b>Door Latch Repair Clip -</b>					
12-0DLC	corrects a lot of door closing issues	each	47-63	\$10.95	
<b>Door Striker- mounts on door jamb (each)</b>					
12-0629-PR	sold as pair only		52-63	\$29.95	
12-0629-R	fits panel / suburban with rear barn doors		52-63	\$14.95	
<b>5/16-18 coarse thread ---- 5/16-24 fine thread</b>					
<b>1/4-20 coarse thread-----1/4-28 fine thread</b>					
<b>PLEASE CHECK BEFORE ORDERING -type of hdw -OE info 1/4 -20 NC SCREWS OR 5/16-24 NF SCREWS @ STRIKER</b>					
<b>12-0629-L</b>		<b>13-0201-52</b>			
					
					
<b>12-0201-N</b>					
					
					
<b>Door Striker Screw Kit -late 57 up did not use 1/4-20 clutch driver screws-used 5/16 -24 UNF hex low washer head bolts</b>					
12-0630	4 screws w/ washers 1/4 -20 NC per side		52-early 57		
<b>Door Striker Hdw kit</b>					
12-0630-K	4 x 1/4-20 NC Philips drive screws w/ washer,shims & nut plates	1 side	52-early 57	\$19.95	
<b>Door Striker Nut Plate</b>					
12-0201-N	threaded ( 1/4 -20 ) plate in backside of "B" pillar for striker screws	pair	47-early 57		
<b>Door Striker hdw kit</b>					
12-0631-K	4x 5/16-18 NC-clutch head stainless screws-4 washers,2 shims & 2 nut plates	per side	Late 57-59		
<b>Door Striker Shims</b>					
13-0201-52	1/8 x 1 7/16 long x 3/4 wide	behind both ends of the striker for correct latch contact			
		pair	52-63	\$5.95	

*Bill's Truck Shop*

Phone (905) 725-3460 / (905) 725-2022 / Fax (905) 404-2302 email: bill@billstruckshop.com

# Door Parts

Due to the fluctuation of the Canadian and American dollars call for current prices

# Group 12

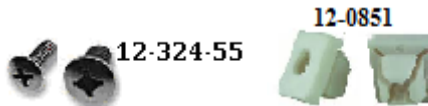
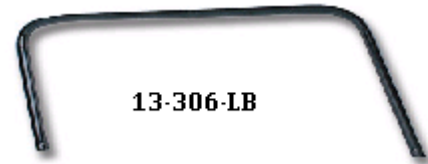
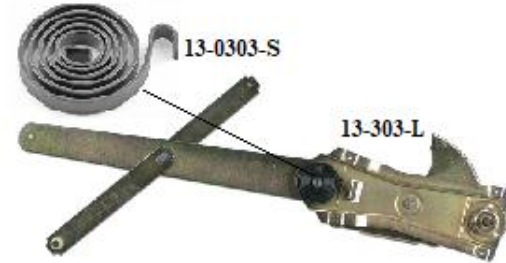

## Door Control

12-305-L	left	55-59	\$42.95
12-305-R	right	55-59	\$42.95

## Door Control Hdw kit -both sides

12-0205-K	6(zinc) screws w/ tooth washer-Philips drive	47-72	\$2.95
-----------	--	-------	--------

13-0302-R	roller & pin	55-63	\$6.25
-----------	--------------	-------	--------

## Window Regulator

13-303-L	left	55-59	\$99.95	\$50.00
13-303-R	right	55-59	\$99.95	\$50.00

## Window Regulator Hdw Install kit

13-0203-SK	per side	51-72	\$2.75
------------	----------	-------	--------

## Window Regulator Gear Assembly w/ rivets

13-0303-G		55-63	\$58.95
-----------	--	-------	---------

## Window Regulator Assist Spring

13-0303-S	at handle shaft	55-87	\$5.00
-----------	-----------------	-------	--------

## Door Window Moulding -Inner

13-306-LB	black	55-59	\$82.95	\$50.00
13-306-RB	black	55-59	\$82.95	\$50.00
13-306-LC	chrome	55-59	\$114.95	
13-306-RC	chrome	55-59	\$114.95	

## Door Moulding Fastener Set-clips/screws/j-nuts

13-307	both doors	55-59	\$18.95
--------	------------	-------	---------

## Door Panel

12-320-L		55-59	\$148.95	\$75.00
12-320-R		55-59	\$148.95	\$75.00

## Door Panel Screw Set

12-324-55	stainless steel screws # 10 & ¼ 24UNC per door	55-55	\$9.95
12-0324-56	stainless steel screws ¼- 20 UNC--- 2 doors	56-66	\$23.95
12-0851	Nuts- to replace missing or damaged door panel pair	56-71	\$1.45

## Bill's Truck Shop

Phone (905) 725-3460 / (905) 725-2022 / Fax (905) 404-2302 email: bill@billstruckshop.com





13-0PW-HS



**Power Windows-** includes chrome switches, wiring harness, US made Sieman motors on original style window regulators w/ complete instructions- Brass iolite thrust bearings at pivots-mfg. by Nu-Relics

13-359-PW	w/chrome switches	55-59	\$984.95
13-359-PW/CS	w/ crank handles switches	55-59	\$999.95

**Crank Handle Switches**

13-0PW-HS	check shaft length	pair	40-72	\$225.00
-----------	--------------------	------	-------	----------

**One Piece Glass**

See product info below

1955-59	Power window kit w/ 1 pc glass	Inquire
13-3PW-1T		

*Bill's Truck Shop*

Phone (905) 725-3460 / (905) 725-2022 / Fax (905) 404-2302 email: bill@billstruckshop.com

This electric kit includes the following for the 1955, 56, 57, 58, and 59 Chevy truck: 2 side windows - choose color, 2 lower glass run channels and 2 electric lift channels attached to window glass, 2 front vent channels with 2 brackets, screws and nuts, 2 upper U felts (bent to fit), 4 lower felts with clips installed, left and right motor with left and right installed brackets, left and right switches with complete wiring and door post wire guides. Easy to follow written instructions with pictures. These are tempered glass only w/ Specialty Power windows drive system

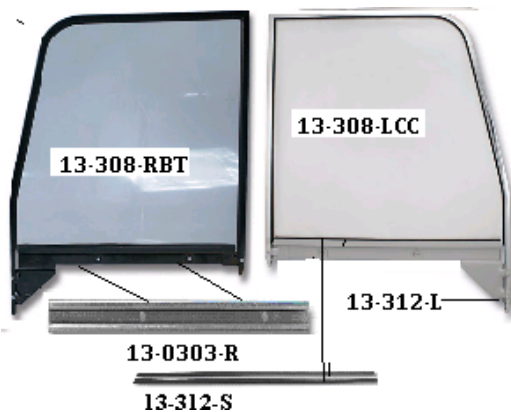

**Door Glass Frame w / glass & sash-----new assembly DO NOT come w/ sash seal # 13-312-S**

13-308-LCT	chrome	w/tinted glass	left	55-59	\$279.95	Inquire
13-308-RCT	chrome	w/ tinted glass	right	55-59	\$279.95	Inquire
13-308-LCC	chrome	w/clear glass	left	55-59	\$279.95	Inquire
13-308-RCC	chrome	w/clear glass	right	55-59	\$279.95	Inquire
13-308-LBT	black	w/tinted glass	left	55-59	\$279.95	Inquire
13-308-RBT	black	w/tinted glass	right	55-59	\$279.95	Inquire
13-308-LBC	black	w/clear glass	left	55-59	\$259.95	Inquire
13-308-RBC	black	w/ clear glass	right	55-59	\$259.95	Inquire

**Door Glass Frame Screws (barrel nut & screw)**

13-0208		each	47-63	\$1.50
---------	--	------	-------	--------

**Door Glass Sash- steel frame on lower glass (each)**

13-312-L		left	55-59	\$59.95
13-312-R		right	55-59	\$59.95

**Window Regulator Roller Guide Rail**

13-0303-R		fits L and R	55-63	\$41.95	\$15.00
-----------	--	--------------	-------	---------	---------

**Screw –window guide to sash kit- 4 screws w/ washers**

13-0303-SK		both sides	55-63	\$3.95
------------	--	------------	-------	--------

**Door Glass Guide Channel rear of door below handle**

13-312-4L			55-59	\$30.00
13-312-4R			55-59	\$30.00

**Door Glass Sash Seal**

13-312-S	& secures glass into sash	each	55-59	\$8.95
----------	---------------------------	------	-------	--------



**Vent Window Assembly**

13-313-TLC	tinted glass w/ chrome vent frame-left	55-59	\$449.95	\$125.00
13-313-TRC	tinted glass w / chrome vent frame-right	55-59	\$449.95	\$125.00
13-313-CRC	clear glass w/ chrome vent frame-right	55-59	\$469.95	\$125.00
13-313-CLC	clear glass w/ chrome vent frame-left	55-59	\$469.95	\$125.00

NOTE-adjust vent post tension spring before installation

**Vent Window Ass install kit-2 doors**

13-313-SK	stainless steel	55-59	\$6.95	
-----------	-----------------	-------	--------	--

**Vent Glass Frame w/o vent handle** -requires  
1-0GST glass setting tape-1/12 W x 0.062 thick

13-314-LCT	left- w/ tinted glass	chrome	55-59	\$145.00
13-314-RCT	right-w/tinted glass	chrome	55-59	NLA

13-314-LC	left w/o glass	chrome	55-59	NLA
13-314-RC	right w/o glass	chrome	55-59	\$79.95

**Spring-Vent Window Frame Tension Spring**

13-0213-S		51-91	\$11.95	
-----------	--	-------	---------	--

*Bill's Truck Shop*

Phone (905) 725-3460 / (905) 725-2022 / Fax (905) 404-2302 email: bill@billstruckshop.com

# Fuel Tank & Parts

Due to the fluctuation of the Canadian and American dollars call for current prices

# Group 14



		<u>Year</u>	<u>New</u>
<b>Gas Tank kit-</b> 19 gallons-top right of centre fill-rear frame mount w/ hdw internal baffles ,zinc plated, silver painted			
14-300-K <b>does not includer fuel sender</b>		55-59	\$599.95
<b>34 " long 18 " wide 13 " deep w/ step on side to frame mount</b>			
<b>Gas Tank-galvanized 18gal</b>			
14-301 pickup		55-59	\$389.95
14-301-PS suburban / panel		55-59	
<b>Gas Tank Straps</b>			
14-301-S pair		55-59	\$69.95
<b>Gas Tank Strap bolt kit</b>			
14-301-SHK 4 bolts w/ washers		55-59	\$5.95
<b>Gas Tank Insulator kit</b>			
14-0GTP 2" x 40 " pair		47-66	\$9.95
<b>Gas Tank Filler kit</b>			
14-302-K includes pipe-hose-grommet-cap		55-59	\$109.95
<b>Gas Tank Floor Seal Donut</b> -seals between gas tank and fuel line/drain hole in floor			
14-0305		49-59	\$2.25
<b>Gas Tank Filler Neck Pipes</b>			
14-302 pickup		55-59	
<b>Gas Tank Filler Neck Grommet</b>			
14-302-3 pickup		55-59	\$8.95
<b>Gas Tank Filler &amp; Vent Hose-clamps not included</b>			
14-0212 also fits 55-59 panel & sub 2pcs		49-59	\$19.95
<b>Gas Tank Filler Hose Clamp</b>			
14-0212-C correct OE style 4pcs		49-59	\$12.95
14-0212-S screw type hose clamps		49-59	\$5.95
<b>Fuel Line Grommet</b>			
14-0425 OD 1-ID3/4-w/ 3/8 hole - at floor		49-59	\$2.95
<b>Gas Tank Sender Wire Grommet</b>			
14-0415 OD 1 -ID 11/16 w/5/16 hole - at floor		49-59	\$2.50
<b>Flexible Fuel Line</b> under tank			
14-0203-3		54-59	\$29.95
<b>Fuel Tank Line</b>			
14-303-L 5/16 line w/ fittings		55-59	\$19.95
<b>Fuel Fill Delete plate</b>			
14-00GD weld in/when relocating fuel tank		55-66	\$23.95

## Bill's Truck Shop

Phone (905) 725-3460 / (905) 725-2022 / Fax (905) 404-2302 email: bill@billstruckshop.com

# Fuel Tank & Parts

Due to the fluctuation of the Canadian and American dollars call for current prices

# Group 14



			<u>Year</u>	<u>New</u>	<u>Used</u>
<b>Gas Tank Sender Unit w/ gasket</b>					
14-304	w/ fuel pickup	30 ohm pickup	55-59	\$58.95	
14-304-PS	panel and suburban	30 ohm	55-59	\$69.95	
14-0204-90	universal application	-90 ohm		\$64.95	
14-0204-30	universal application	-30 ohm		\$64.95	
<b>Fuel Sender Pickup Screen</b>					
6-0204-S	OE metal type	for 5/16 line	54-72	\$28.95	
<b>Gas Tank Sender Unit Gasket</b>					
14-0593			47-66	\$2.50	
<b>Gas Tank Sender Screw Kit</b>					
14-0594			47-66	\$3.00	
<b>Gas Tank Sender Float</b>					
6-0204		brass	47-72	\$11.95	
<b>Fuel Door Bumper</b>					
6-0210	panel & suburban	pair	55-59	\$4.00	
<b>Gas Cap – Original Type vented</b>					
6-0GCS	stainless steel	NEW PRICE!!	47-70	\$15.95	
6-0GCP	paint to match		47-70	\$27.00	
<b>Locking Gas Cap—non vented</b>					
14-0416	chrome w/ bowtie lock cover		47-70	\$55.95	
14-0417	chrome -smooth w/2 keys		47-70	\$22.95	
<b>Cool Cap</b>					
14-0FCC	flush mount, billet aluminium, screw cap w/ 1 1/2 fill neck, 3" flange	NON venting		\$99.95	
14-00FH	fuel hose/ neoprene 4" long x 1 1/2 ID w/ clamps			\$16.95	

## Bill's Truck Shop

Phone (905) 725-3460 / (905) 725-2022 / Fax (905) 404-2302 email: bill@billstruckshop.com



# SPARE TIRE

Due to the fluctuation of the Canadian and American dollars call for current prices

# Group 14

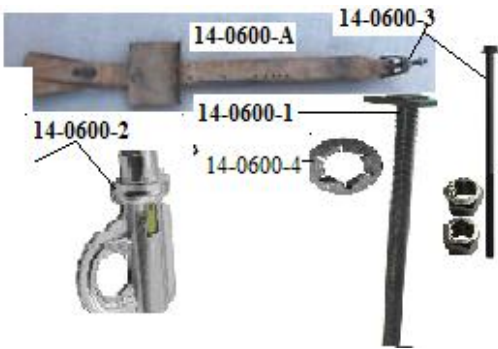

## SPARE TIRE HARDWARE

### Grommet

14-0610 for support brace in fender –short step side trucks fits 1 ¾ hole

		<u>Year</u>	<u>New</u>	<u>Used</u>
14-0610	for support brace in fender –short step side trucks fits 1 ¾ hole	55-66	\$7.95	
14-0600-A	tire support assembly w/ pivot bolt	53-59		\$125.00
14-0600-1	bolt –support release bolt	54-87	\$22.95	\$10.00
14-0600-2	nut-lock bolt nut w/ nylon insert	54-87	\$12.95	\$5.00
14-0600-3	bolt-tire support pivot	54-87	\$22.95	\$5.00
14-0604-15	tire support on L fender 15 “wheels	54-87		Inquire
14-0604-16	tire support on L fender 16 “ wheels	54-87		Inquire
14-3604	tire support in bed---fleetside	58-59		\$75.00

Check our website [www.billstruckshop.com](http://www.billstruckshop.com) for California trucks and parts

## Bill's Truck Shop

Phone (905) 725-3460 / (905) 725-2022 / Fax (905) 404-2302 email: [bill@billstruckshop.com](mailto:bill@billstruckshop.com)

# Glass & Trim

Due to the fluctuation of the Canadian and American dollars call for current prices

# Group 15

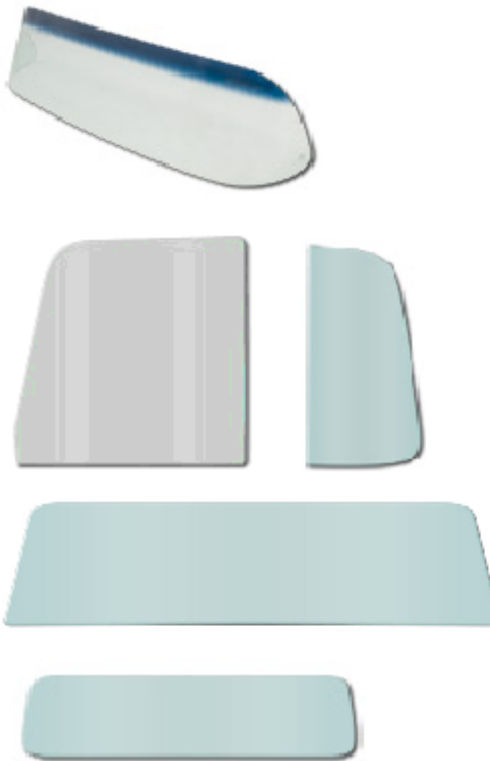

Front glass are laminated / rear and side glass are tempered all glass DOT approved

Year

New

### Windshield

15-301-C	clear (special order-10 days)		55-59	\$449.95
15-301	tinted only -NO upper shade		55-59	\$449.95
15-301-T	tinted w/ shaded top		55-59	\$449.95

Door Glass-----requires seal # 13-312-S to install in sash

15-303-C	clear	each	55-59	\$63.95
15-303-T	green tint	each	55-59	\$63.95
15-303-G	gray tint		55-59	\$63.95

### Vent Glass

15-305-C	clear		55-59	\$49.95
15-305-T	green tinted		55-59	\$52.95
15-305-G	gray tint		55-59	\$54.95

Uses 1-0GST-1 on vent glass install

### Back Glass

15-306-SC	small clear		55-59	\$119.95
15-306-ST	small tinted		55-59	\$124.95
15-306-SG	small gray tint		55-59	\$129.95
15-306-LC	large clear		55-59	\$399.95
15-306-LT	large tinted		55-59	\$469.95
15-306-LG	large grey tinted		55-59	\$424.95

Rear Barn Door Glass-panel/suburban

15-307-CL	clear/left		55-59	\$64.95
15-307-CR	clear/right		55-59	\$64.95
15-307-TL	green tint/right		55-59	\$144.00
15-307-TR	green tint/right		55-59	\$144.00

### Rear Hatch Glass

15-308-C	clear		55-59	Inquire
15-308-T	green tint		55-59	Inquire

*Bill's Truck Shop*

Phone (905) 725-3460 / (905) 725-2022 / Fax (905) 404-2302 email: bill@billstruckshop.com

# Glass & Trim

Due to the fluctuation of the Canadian and American dollars call for current prices

# Group 15

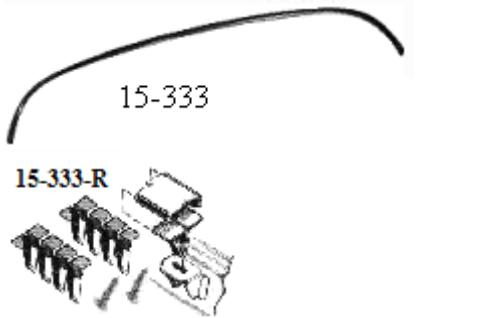

### Windshield Dash Trim -lower

	<u>Year</u>	<u>New</u>	<u>Used</u>
15-333	55-59	\$109.95	\$60.00

### Windshield Dash Trim Retainer set

15-333-R	w/ screws	55-59	\$15.95
----------	-----------	-------	---------

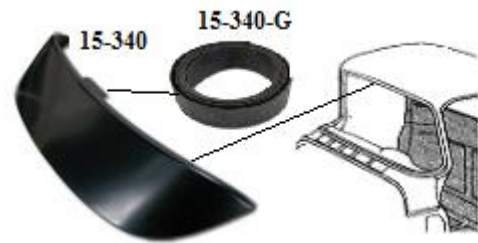

### Outside Sun visor

15-340	steel w/hardware	55-59	\$249.95
--------	------------------	-------	----------

15-340-G	roof to visor gasket	55-59	\$10.95
----------	----------------------	-------	---------



### Windshield Trim

*inquire on individual used pieces*

24-304-F	stainless trim in front glass seal - set	55-59	\$229.95
----------	--	-------	----------

24-304-J	stainless jointers for glass trim - each	55-59	\$3.95
----------	--	-------	--------

## Bill's Truck Shop

Phone (905) 725-3460 / (905) 725-2022 / Fax (905) 404-2302 email: [bill@billstruckshop.com](mailto:bill@billstruckshop.com)

# Lights Lamps Lens

Due to the fluctuation of the Canadian and American dollars call for current prices

# Group 16

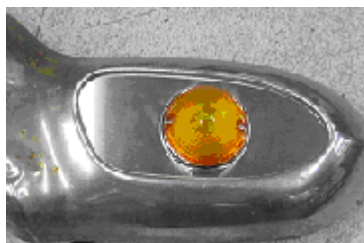
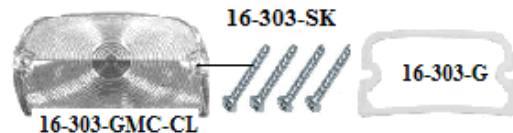

## Parklamp Lens

			Year	New	Used
16-303-GMC-CL	GMC clear-	left	55-57	\$29.95	
16-303-GMC-CR	GMC clear-	right	55-57	\$29.95	

## Parklamp Lens Gasket (pair)

16-303-G	GMC - pair		55-57	\$13.95	
----------	------------	--	-------	---------	--

16-304-GMC-K 58-59 GMC park light kit -  
**Replace** the OE style glass lens w/-brushed stainless steel inserts and **ADD** either **amber** or **clear** park light assemblies ( 16-301-HC or 16-301-HA )  
 pair 58-59 \$93.00

## Park lamp Housing Assembly w/ harness & lens

16-301-HC	Chev/ with clear lens	- each	55-57	\$49.95	
16-301-HA	Chev/ with amber lens	- each	55-57	\$49.95	
16-303-SK	4 stainless screws----	GMC	55-57	\$2.95	

## Park lamp Housing Assembly w/ harness & lens

16-303-HA	GMC	-each	55-57		
16-304-L	OE assembly	left	58-59	\$324.95	
16-304-R	OE assembly	m right	58.-9	\$324.95	
16-304-HA	GMC	-each	58-59		Inquire

\$30.00

## Socket-signal & brake

16-0428	2 wire for signal-brake & running light- accepts 2 pin 1157 bulb	each		\$7.95	
---------	--	------	--	--------	--

## Bill's Truck Shop

Phone (905) 725-3460 / (905) 725-2022 / Fax (905) 404-2302 email: bill@billstruckshop.com



			<u>Year</u>	<u>New</u>	<u>Used</u>
<b>Parklamp Lens</b>					
16-301-C	Chev clear-	each	55-57	\$8.95	
16-301-A	Chev amber	each	55-57	\$8.95	
16-302-C	Chev clear	each	58-59	\$7.95	
16-302-A	Chev amber-	each	58-59	\$8.95	
<b>Park lamp Screw set</b>					
16-302-SK	4 stainless screws --Chev		58-59	\$2.25	
<b>Park lamp Housing Assembly w/ harness &amp; lens</b>					
16-301-HC	Chev/ with clear lens	- each	55-57	\$49.95	
16-301-HA	Chev/ with amber lens	- each	55-57	\$49.95	
16-302-HC	Chev /with clear lens	-each	58-59	\$89.95	
16-302-HA	Chev/ with amber lens	-each	58-59	\$89.95	
<b>Parklamp Lens Gasket (pair)</b>					
16-301-G		Chev - pair	55-57	\$2.95	
16-302-G		Chev - pair	58-59	\$4.95	
<b>Park lamp Housing to Fender Gasket</b>					
16-301	Chev	pair	55-57	\$5.95	
<b>Park lamp Bezel</b>					
16-302-B	Chev chrome L or R	each	58-59	\$76.95	\$30.00
<b>Park lamp Harness Grommet</b>					
16-305-G	1 each side of rad support	pair	55-59	\$5.95	
<b>Socket-signal &amp; brake</b>					
16-0428	2 wire for signal-brake & running light- accepts 2 pin 1157 bulb	each		\$7.95	





		<u>Year</u>	<u>New</u>	<u>Used</u>
<b>Headlamps</b>				
16-0206-12	12 volt Halogen		\$22.95	\$10.00
16-05001H	GMC high (inner) Halogen each	58-72 GM 60-62 Che	\$21.00	
16-05006H	GMC high/low (outer) Halogen each	58-72 GM 60-62 Che	\$20.95	
<b>Headlight Bezel Screws= stainless steel</b>				
16-355-S		6 pcs 55-57	\$2.50	
16-358-S		8 pcs 58-59	\$2.95	
<b>Headlamp Bezel Seals w/ wire core as original</b>				
16-0207-1		pair 47-57	\$15.95	
<b>Headlamp Bulb Retainer Ring-</b>				
16-3HR	stainless steel w/o hold down ears	55-57	\$21.95	
19-0HR-2	58-61 Chev & 58-64 GMC w/ 2 retainer tabs each	58-64	\$11.95	
<b>Headlamp Bulb Retainer Ring Screws</b>				
12-0HRS-6		47-87	\$2.95	
<b>Headlamp Adjusting Screws and Nut</b>				
16-0207-A	1 screw w/ threaded nylon nut	47-57	\$4.95	
16-0432	1 adjuster w/hdw	58-61	\$2.95	
<b>Headlamp Adjuster Spring w/ hdw</b>				
16-0207-S	each w/ hdw	47-59	\$4.95	
<b>Headlight Ring Support/Post</b>				
16-0208	secures to light pot lower w/ hdw each	47-57	\$8.95	
<b>Headlamp Bucket to Fender Gaskets</b>				
16-0515		pair 47-57	\$8.95	
16-315-58	black sealer/caulking strips set	58-59	\$12.95	

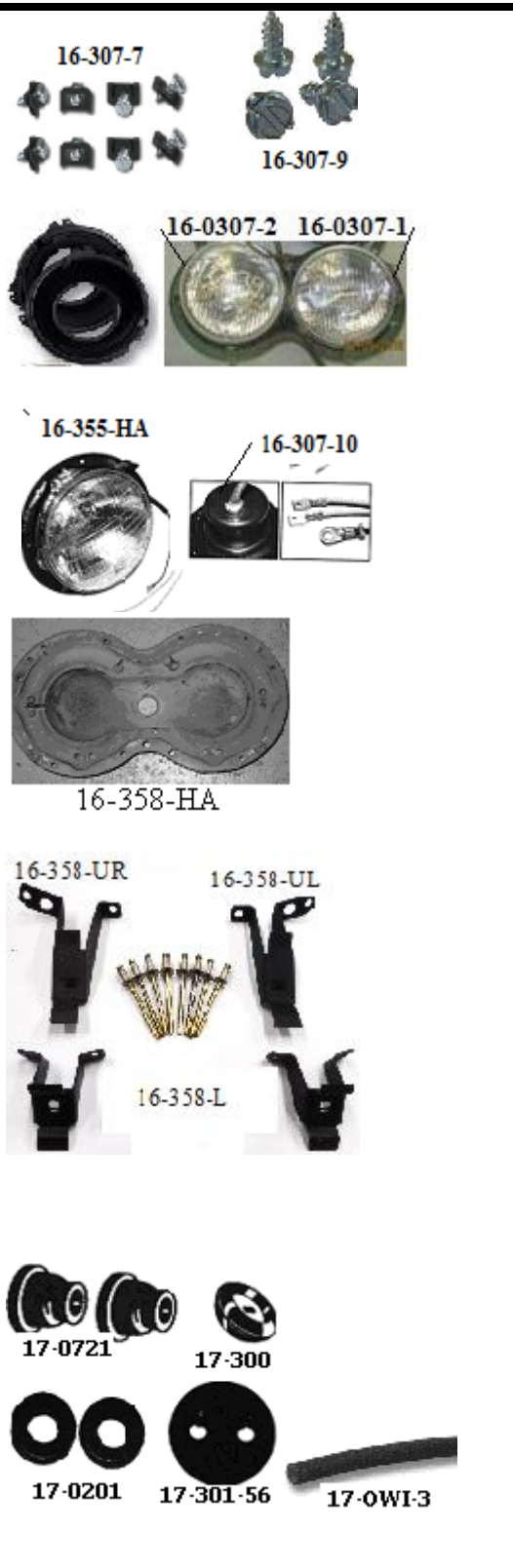

			<u>Year</u>	<u>New</u>	<u>Used</u>
<b>Headlamp Bucket to Fender mount kit</b>					
16-307-7	screws w/ j nuts	16pcs	55-57	\$10.95	
16-307-9	screws only	14pcs	58-59	\$4.95	
<b>Headlamp Cup for head light</b>					
16-307-10	w/ guide tab w/ o screw holes to secure light retainer Chev	each	55-57		\$20.00
The following "cups" fit <b>58-61 Chev and 58-66 GMC</b> -includes retainer ring					
16-0307-1	outer / left -drivers side		58-66	\$42.95	
16-0307-2	inner / left- drivers side		58-66	\$42.95	
16-0307-3	outer / right - pass side		58-66	\$42.95	
16-0307-4	inner / right - pass side		58-66	\$42.95	
Note-cups are stamped w/ "1 for inside and "2 for outside w/ L for left and R for right -headlight must sit vertical					
16-0307-K	4 cups w/ rings		58-62	\$159.95	
<b>Headlamp Bucket Assembly-</b>					
16-355-HA	w/ universal harness w/o bulb -each		55-57	\$99.95	
16-355-HAB	w/ OE style harness, hdw & 12V seal beam		55-57	\$189.95	
16-358-HA	w/ light ring/harness / light pot -each		58-59	Coming	
<b>Headlamp Bezel Stands—w/ rivets--sold as each -up R is the in on L///// up L is the in R</b>					
16-358-UL	upper bezel stand---outer R/ inner L		58-59	\$9.95	
16-358-UR	upper bezel stand-inner right/outer R		58-59	\$9.95	
16-358-L	lower bezel stand		58-59	\$6.95	
16-358-K	4 pc kit w/ hdw for 1 side		58-59	\$34.95	
<b>Headlamp Bucket Wire Grommets</b>					
17-0721		pair	47-57	\$5.95	
17-300	one per housing	pair	58-59	\$18.95	
<b>Headlight Wiring Inner Fender Grommet</b>					
17-0201	hole diameter 3/4 "	pair	47early56	\$3.25	
17-301-56	hole size 1 3/8 w/ 2 hole grommet	each	late 56-57	\$2.95	
17-301-58	single 15/16 hole in inner fender -	pair	58-59	\$2.50	
<b>Headlight Wiring Loom Black fabric over wire as original</b>					
18-0WL-1	1/4 ID	per foot		\$1.50	
18-0WL-3	3/8 ID	per foot		\$1.70	
18-0WL-5	1/2 ID	per foot		\$1.95	

*Bill's Truck Shop*

Phone (905) 725-3460 / (905) 725-2022 / Fax (905) 404-2302 email: bill@billstruckshop.com

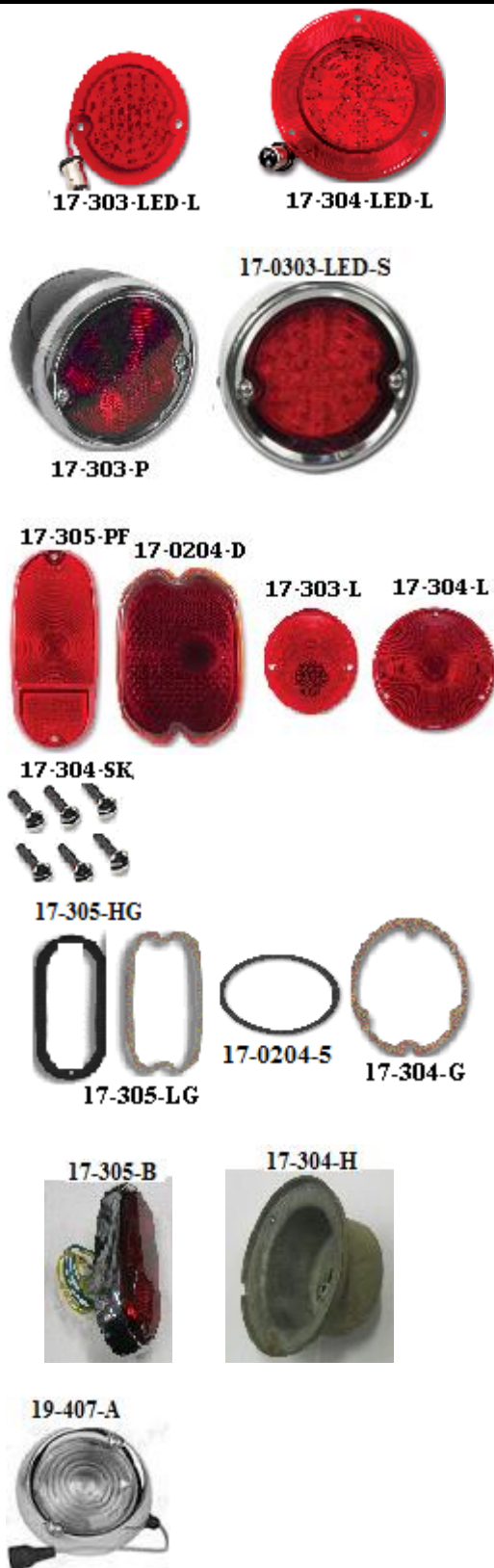

			<u>Year</u>	<u>New</u>	<u>Used</u>
<b>Tail lamp Assembly with Wiring –stepside</b>					
17-303-P	painting w/ stainless steel bezel	each	55-59	\$68.95	
17-303-S	stainless steel	each	55-59	\$79.95	
<b>Tail lamp Assembly w/ LED lightning</b>					
17-0303-LED-S	stepside stainless steel housing w/wiring - each		54-59	\$99.95	
17-0303-LED-P	stepside-black w/ housing w/ wiring each		54-59	\$89.95	
<b>Tail Lamp Lens—LED includes harness w/ socket</b>					
17-304-LED-L	fleetside-LED lens fits OE housing-each		58-59	\$64.95	
17-303-LED-L	stepside LED lens fits OE housing - each		55-59	\$69.95	
17-303-L	stepside	each	55-59	\$6.95	
17-304-L	fleetside	each	58-59	\$9.95	
<b>Tail Lamp Lens Screw kit-if holes are enlarged insert some wire for screws to tighten</b>					
17-304-SK	stainless steel-fleetside	6 pcs	58-59	\$2.00	
17-305-SK	stainless steel-panel #8-32	4 pcs	56-59	\$1.00	
<b>Tail Lamp Lens—Panel or Suburban</b>					
17-0204-D	oval red w /barn doors only		47-56	\$21.95	
17-305-PF	plastic on fender	each	55-59	\$22.95	
17-0204-C	round red w/ clam shell doors only		47-59	inquire	
<b>Tail lamp Lens Gasket</b>					
17-0204-5	stepside	pair	55-59	\$3.95	
17-304-G	fleetside	pair	58-59	\$8.95	
17-0204-6	subur/ panel truck w/oval lens w/ taillight on rear door w/ side by side doors only		47-56	\$4.60	
17-305-LG	suburban/panel w/ lights on ¼ panel	pair	55-59	\$6.95	
<b>Taillamp Body Mount Gasket – rubber</b>					
17-305-HG	suburban/panel w/ lights on ¼ panel	pair	55-59	\$12.50	
<b>NEW rubber molded</b>					
<b>Taillight Assembly suburban/panel on ¼ panel</b>					
17-305-B	chrome housing w/ plastic lens & stub harness left & right are the same –rotate lens for other side	each	56-59	\$119.95	
<b>Taillight Housing</b>					
17-304-H	fleetside	each	58-59	\$59.95	
<b>Reverse Light Assembly can install 60-66 rev light assembly on 58-59 fleet side box below brake light</b>					
19-407-A	reverse light assembly	each	60-66	\$89.95	

			<u>Year</u>	<u>New</u>	<u>Used</u>	
	<b>Tail lamp Bezel</b>					
	17-303-B	stainless steel –stepside	each	55-59	\$10.95	
	17-304-B	aluminium – fleetside	each	58-59	\$23.95	
	17-0205-2	chrome sub/panel truck w/oval lens w/ side by side doors only		47-56	\$33.95	
	17-0205-C	w/ clam shell doors only-round		47-59	inquire	
	<b>Tail lamp Wire Conduit / stainless steel</b>					
	17-0208	18 in long	pair		\$19.95	
	<b>Taillamp Wire Grommet</b>					
	17-0208-G		pair	47-72	\$2.75	
	<b>Blue dot w/chrome bezel (pair)</b>					
17-0209-P	Plastic	pair		\$11.95		
<b>Taillamp Bracket</b>						
<b>Painted</b>						
17-0510-BL			55-66	\$10.95		
17-0510-BR			55-66	\$10.95		
<b>Chrome</b>						
17-0510-CR			55-66	\$18.95		
17-0510-CL			55-66	\$18.95		
<b>Taillight Bk Bolt kit</b>						
17-0510-KA	philips drive w/ washer-stainless steel	8 pc kit	54-72	\$7.95		
17-0510-KB	7/16 hex head w/ washer-stainless steel	8 pc kit	54-72	\$7.95		
<b>Taillamp Assembly w/ plate bracket</b> -mounts on left rear door on panel, suburban—side by side doors only						
17-0206			47-56		\$150.00	
17-0205-C	w/ clam shell doors only-folds out when lower gate opens-		47-59		\$200.00	
<b>Taillamp Assembly Mount Pad</b> -between light housing and bracket						
17-0206-P	moulded rubber pad		47-56	\$69.95		
<b>Taillamp Harness Grommet</b> - w/ side by side doors						
17-0206-G	in door behind housing		47-56	\$2.50		
<b>License Light Lens</b>						
17-0206-L			47-56	\$39.95		
<b>License Lens Gasket</b> - w/ side by side doors						
17-0206-LG			47-56	\$1.55		
<b>Hood Light Kit</b>						
15-0HL	OE accessory kit		47-72	\$69.95		

*Bill's Truck Shop*

Phone (905) 725-3460 / (905) 725-2022 / Fax (905) 404-2302 email: bill@billstruckshop.com





### License Plate Bracket & Lamp Assembly

		<u>Year</u>	<u>New</u>	<u>Used</u>
18-303-S	stepside –secures to rear cross sill	54-59	\$59.95	
18-0303-F	fleetside-mounts to bumper	58-66	\$69.95	
18-0812	plate bkt bolts- stainless capped bolt @ bumper pair	58-66	\$9.95	
18-0303-L	plate light lens-glass	58-66	\$9.95	
18-0303-G	plate light lens- gasket	58-66	\$1.50	
18-0303-U	mount @ rear cross sill w/ no rear bumper	54-87	\$19.65	
18-0389	bulb-plate light-single contact-level pins 12V 6 CP each		\$1.95	

### Wire Harness Clips

18-0205-S	for sheet metal	each	47-72	\$1.95
18-0205-OE	OE style frame harness clip	each	41-59	\$3.79
18-0205-F	at frame locations	each	47-72	\$1.50
37-0315	insulated clamp style w/ hdw	pair		\$2.00
18-0205-P	OE plastic LOOP style found on GMC pickups at inner fenders	set of 4	55-62	\$7.50
18-0205-B	OE brass tie straps used to secure wiring harness and washer hose under the dash and engine bay	pair	55-62	\$9.95

### Wiring Loom black fabric as original

18-0WL-1	¼ in diameter.	Per foot		\$1.10
18-0WL-3	3/8 in diameter	Per foot		\$1.35

### Wiring Conduit –plastic, black, ribbed, split wiring covering

18-0WC-1	¼ in dia	Per foot		\$0.60
18-0WC-3	3/8 in dia	Per foot		\$1.00
18-0WC-5	½ in dia	Per foot		\$1.10

### Wiring Plug w/ grommet @ connectors

18-0547	universal 8 plug pass through connector kit			\$22.95
---------	---	--	--	---------

*Bill's Truck Shop*

Phone (905) 725-3460 / (905) 725-2022 / Fax (905) 404-2302 email: bill@billstruckshop.com



# WIRING HARNESS

Due to the fluctuation of the Canadian and American dollars call for current prices

# Group 18

17-0208-B



18-304-A

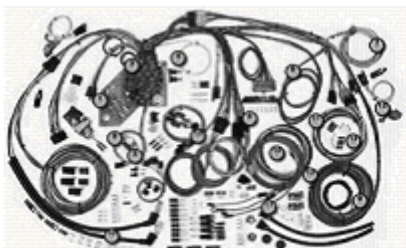

18-3481

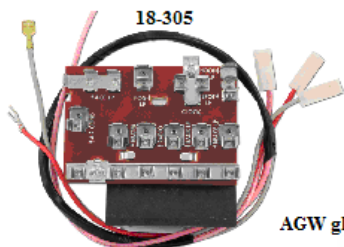

heater-----20 amp  
radio-----5 amp  
backup-----10 amp  
brake-----20 amp  
spot-----10 amp  
fog-----10 amp  
AC-----25 amp

AGW glass fuses 1/4 x 7/8

ATO spade fuses



6 output connectors

18-0023

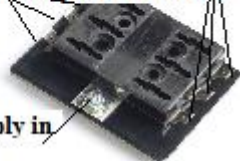

power supply in

18-0832



**Wiring Harness** –PVC coated copper wiring in the correct colour code to replace the original wiring. Complete front to rear W/ detailed instructions. 6 or 8 cyl-  
**Gen** harness to use with Original system & **Alt** w/ internal regulator type –NOT a direct fit for GMC some modifications required for GMC-fleetside require 2 x 17-0208-B

		Year	New	Used
18-304-G	w/ generator	55-59	\$499.95	
18-304-A	w/ alternator	55-59	\$499.95	

**Taillamp Socket w/ Wire & Rubber Boot**

17-0208-B	taillights	each	47-66	\$8.95
-----------	------------	------	-------	--------

**Custom Classic Updated Wiring Harness kit- by American Autowire**

An excellent replacement updated wiring harness w/ blade type 18 fuse –21 circuit –includes plugs, switches for original or aftermarket gauges-HEI or point type dist harness- column connectors for stock or updated columns-front, rear & dome, under dash light harness-updates for original or AC updates, power windows, seats, stereo, electric fuel pumps etc-includes complete instructions, grommets, connectors, fuses, flasher extra wiring ties

18-3481			55-59	\$1224.95
---------	--	--	-------	-----------

**Fuse Block**

18-305	w/ primary wiring & instructions		55-59	\$69.95
--------	----------------------------------	--	-------	---------

**When adding electric wipers and using w/ fuse panel-power can also be supplied through AC fuse terminal OR ignition switch w/ pre-fused wipers**

**Fuses----- all acc fuse panel fuses are 1/4 x 7/8 long AGW glass fuses**

AG Fuses Originally stood for “all glass.” The automotive industry uses the “AG” prefix (AGC, AGW) for most glass fuses. They vary in length, diameter and amperage rating.

18-0674-25	25 amp	each		\$0.99
18-0673-20	20 amp	each		\$0.99
18-0671-10	10 amp	each		\$0.99
18-0670-5	5 amp	each		\$0.99

**Accessory fuse panel**

18-0023	6 pin/uses ATO spade fuses			\$49.95
---------	----------------------------	--	--	---------

**Fusible Link**

18-0832 9 “ 12 gauge slow burn wire- fuse wire is usually 4 gauges smaller then circuit wire w/ connectors-excellent safety precaution installed to ignition feed wire at starter approx. 20-25 amps---add to starter-ignition dash feed

\$3.50

## Bill's Truck Shop

Phone (905) 725-3460 / (905) 725-2022 / Fax (905) 404-2302 email: bill@billstruckshop.com

# WIRING HARNESS

Due to the fluctuation of the Canadian and American dollars call for current prices

# Group 18



All apply to OE application-CHEV----- special order only -will quote cost at time of order

Year      New      Used

### Headlamp Harness –lamps to connector-pr

18-307-55H		55-57	\$49.95
18-307-58H		58-59	\$49.95

### Socket-headlamp harness repair

16-0001	3 wire	each	\$3.95
---------	--------	------	--------

### Front light harness

18-3350	6 cyl w/ stock generator	12 volt	55-55	Inquire
18-3035	V8 w/stock generator	12 volt	55-55	Inquire
18-3415	V8 w/stock generator		56-56	Inquire
18-3400	6 cyl w/stock generator		56-56	Inquire
18-3045	6 cyl w/ stock generator & signals		56-56	Inquire
18-3030	V8 w/stock generator & signals		56-56	Inquire
18-3555	w/ stock generator		57-57	Inquire
18-3040	w/stock generator & signals		57-57	Inquire
18-3860	w/ stock HD generator		57-57	Inquire
18-3805	w/stock HD generator		58-58	Inquire
18-3715	w/stock generator		59-59	Inquire
18-3055	w/ stock generator & signals		58-59	Inquire

### Rear Body Harness

18-3158	Cameo only		55-55	Inquire
18-3370	w/ brake, tail & signal lights		55-55	Inquire
18-3155	<b>extension</b> w/ long bed/pair		55-59	\$31.95
18-3164	Cameo only		56-56	Inquire
18-3350-A	w/ brake, tail & signal lights			\$33.95
requires #18-3155	w/ long bed		56-56	
18-3166	Cameo only		57-58	Inquire
18-3150	w/ brake, tail & signal lights-			\$151.95
requires #18-3155	w/ long bed		57-59	

### Grommet-@ rear frame crossmembers

18-310-G	protects harness to rear	each	55-59	\$3.25
----------	--------------------------	------	-------	--------

### Transmission Overdrive

18-3280	w/ V8		55-56	Inquire
18-3545	w/ V8		57-57	Inquire

### Turn Signal Harness

18-3365	dash side		55-55	Inquire
18-3430	engine side		55-55	Inquire
18-3360	dash side		56-56	Inquire
18-3570	engine side		56-56	Inquire
18-3355	dash side		57-59	Inquire

## Bill's Truck Shop

Phone (905) 725-3460 / (905) 725-2022 / Fax (905) 404-2302 email: bill@billstruckshop.com



18-3290

All apply to OE application-CHEV----- special order only -will quote cost at time of order

Engine / Starter Harness-all w/ generator			
18-3400-A	6 cyl w/ auto trans 12 V	55-55	Inquire
18-3395	6 cyl w/ manual trans 12 V	55-55	Inquire
18-3285	8 cyl w/ auto trans 12 V	55-55	Inquire
18-3385	8 cyl w/ manual trans 12 V	55-56	Inquire
18-3290	V8 w/auto trans & HEI	55-56	Inquire
18-3295	V8 w/manual trans & HEI	56-56	Inquire
18-3395-A	6 cyl w/ auto trans	56-56	Inquire
18-3390	6 cyl w/ manual trans	56-56	Inquire
18-3405	V8 w/auto trans	56-56	Inquire
18-3425	V8 w/ manual trans	57-57	Inquire
18-3570-A	6 cyl w/ auto trans	57-57	Inquire
18-3550	6 cyl w/ manual trans	57-57	Inquire
18-3560	V8 w/ auto trans	57-57	Inquire
18-3565	V8 w/ manual trans	57-59	Inquire
18-3310	V8 w/ auto trans & HEI	57-59	Inquire
18-3315	V8 w/ manual trans & HEI	58-59	Inquire
18-3910	6 cyl w/ auto trans	58-59	Inquire
18-3905	6 cyl w/ manual trans	58-59	Inquire
18-3735	V8 w/ auto trans	58-59	Inquire
18-3810	V8 w/ manual trans	58-59	Inquire
18-3790	V8 w/ manual & over speed governor light		Inquire

### Dash Harness

18-3465	w/ 12 volt	55-56	Inquire
18-3750		57-59	Inquire









15-0HL

Under Hood Lamp---early 1960 GM reproduction option

15-0HL			\$69.95
--------	--	--	---------

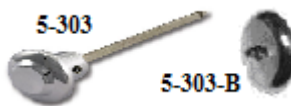
*Bill's Truck Shop*

Phone (905) 725-3460 / (905) 725-2022 / Fax (905) 404-2302 email: bill@billstruckshop.com

			<u>Year</u>	<u>New</u>	<u>Used</u>
	<b>18-307</b>	<b>Headlamp Switch</b>			
	18-307	OE style w/ fuse NO rod & knob	55-59	\$62.95	
	18-0332	must be used when adding halogen lights to carry increased amp load –includes “3 sided” shaped rod, aluminum knob and retainer –can use #36-309 radio knob to match other dash knobs	47-59	\$49.95	
	<b>18-207-12U</b>	Headlight Switch-12V universal application w/rod & chrome knob --screw on pins	47-59	\$37.95	
		<b>Headlamp Switch Retainer/Bezel</b>			
	5-303-B		55-59	\$15.95	
		<b>Light Knob and Rod</b>			
	5-303	Chev w/ chrome knob	55-59	\$14.95	\$5.00
	<b>5-303</b>				
	5-303-W	GMC w/ white knob	55-59		\$15.00
		<b>Terminal Block-secures to rad support on GMC truck</b>			
	<b>18-0332</b>				
	17-303-3	3 pin w/o signals lights	each 55-59	\$16.95	
	17-303-4	4 pin w/ signals lights	each 55-59	\$16.95	
	<b>OE 1955 GMC sample picture</b>				
	17-303-3				
	17-303-4				
	<b>19-0131</b>	<b>Breaker less Ignition system</b> for V8 GM dist-never change point again-uses a Hall Effect magnetic	56-74	\$245.00	

*Bill's Truck Shop*

Phone (905) 725-3460 / (905) 725-2022 / Fax (905) 404-2302 email: bill@billstruckshop.com



# Electrical

Due to the fluctuation of the Canadian and American dollars call for current prices

# Group 18



		<u>Year</u>	<u>New</u>	<u>Used</u>
<b>Dimmer Switch w/ screws</b>				
18-308-55	push on staggard terminal	55-56	\$28.95	
18-308-57	push on pins-"T" position	57-60	\$24.95	
<b>Dimmer switch -screw kit</b>				
18-0305	2 pcs	39-61	\$1.00	
<b>Horn Relay</b>				
18-0209	6 or 12 V w/ screw on terminals	41-56	\$34.95	
18-0309-57	push on terminals	57-62	\$39.95	
<b>Horn</b>				
18-0210-6	6 volt inquire about original horns			
Chev OR GMC	high or low tone	55-59		\$50.00
14-042-H	12V high tone -universal	47-87	\$21.95	
14-042-L	12V low tone - universal	47-87	\$21.95	
<b>Turn signal Switch Assembly</b>				
18-0551-U	universal column mount w/4-way& instructions-requires 3 pin flasher	47-59	\$52.95	
Note-----54-56 signal bowl signal lever exits straight out and 58-59 comes out on upper angle				
18-0211	in upper bowl-has loose harness connectors	55-56	\$36.95	
18-311-57	in upper bowl w/ plug adaptor for harness	57-59	\$39.95	
<b>Turn signal Wire Connector (For # 18-311-S)</b>				
18-0211-1		54-59	\$2.25	
<b>Turnsignal Housing Assembly w/ signal switch-</b> does not include signal lever # 5-305-1				
18-0311-54H	original cup type on column	54-56	\$199.95	
18-311-57H	original cup type on column	57-59	\$199.95	
<b>Turn Signal Housing Wedge</b>				
18-0211-W	locks signal bowl to column	54-59	\$3.75	
<b>Signal Flasher Plug and Harness &amp; Bracket</b>				
18-213-P			\$39.95	
<b>Turn signal Flasher</b>				
18-0213-F6	6 volt 3 pin		\$26.75	
18-0213-F12-L	12 volt 3 pin-use w/ LED lights		\$21.95	
18-0213-F12-L2	12 volt 2 pin-use w/ LED lights		\$22.50	
18-0213-F12	12 volt 3 pin		\$24.95	
14-0SF-12	12 volt 2 pin		\$9.95	
14-0SF-12HD	12 volt HD electronic		\$14.95	
<b>Turn signal Switch Cancel Plate</b>				
18-0214	Cancel original type turn signals.	54-59	\$5.60	
<b>Turn signal Switch Cancel Plate install kit</b>				
18-0214-HK	2 screws w/ washers	54-66	\$1.25	

*Bill's Truck Shop*

Phone (905) 725-3460 / (905) 725-2022 / Fax (905) 404-2302 email: bill@billstruckshop.com



### Ignition Switch w/o keys

18-301-55F	off & on position only for foot start	55-59	Inquire
18-301-55	V8/ key start—will accept 18-013 & 18-013-B cyl & key double release hole	55-56	\$79.95
18-301-57	V8 key start- will accept 18-013 & 18-013-B double release hole	57-59	\$59.95
18-0632	universal type- w/ aluminium retainer -5 pin w/ 4 position - key start—includes instructions	55-66	\$49.95
18-0670	universal type- w/ aluminium retainer -5 pin w/ 4 position - key start—includes instructions , <b>harness plug w/ connectors</b> ---accepts OE indicator dial---does not include keys	55-59	\$59.95

### Ignition Switch Harness

18-3444	Adapts the 57-59 OE harness to the 55-56 repro ignition switch	57-59	
---------	--	-------	--

### Ignition Cylinder w/OE Style Keys

18-013	single hole for spring pi entry	47-66	\$21.95
18-013-B	extension allows for vehicle to be started w/o keys if not placed in lock position-also need keys to place in lock position- w/ 2 keys---2 hole for spring pin entry	47-66	\$25.95

### Key-blank GM key

18-013-	BLANK ignition-door-glovebox	47-66	\$8.95
---------	------------------------------	-------	--------

### Ignition Indicator Dial

18-301-D	w/ v8	55-59	\$12.95
----------	-------	-------	---------

### Ignition Switch Bezel

18-301-OE	original style w/larger 1 9/16 outer dia	55-59	\$10.00
18-301-B	1 3/8 outer dia	55-59	\$17.95

### Starter Switch – at starter

18-0202-ST	w/ side terminal for 12 v ignition feed	38-59	\$35.95
18-0202	w/ out side terminal	38-59	\$25.95

### Push Button Start Switch

18-0TB2	dash mount push button start switch-w/ aut trans or electric start solenoid 15A@12V 5/8 shaft dia		\$19.95
---------	---	--	---------

### Brake Light Switch w/ screws

18-304		55-59	\$11.95
--------	--	-------	---------

### Brake Switch Screw kit

18-0217	pair	42-59	\$1.00
---------	------	-------	--------

### Upper Column Bearing w/ Horn Wire

18-0311		47-59	\$84.95	\$30.00
---------	--	-------	---------	---------

### Horn Wire Cover @ lower column

18-0211-C		47-59	\$10.00
-----------	--	-------	---------

**Bill's Truck Shop**

Phone (905) 725-3460 / (905) 725-2022 / Fax (905) 404-2302 email: bill@billstruckshop.com



# Electrical

Due to the fluctuation of the Canadian and American dollars call for current prices

# Group 18

			<u>Year</u>	<u>New</u>	<u>Used</u>
		<b>Dash Bulb Socket</b>			
		18-0DB-S USED OE metal socket w/ NEW harness	47-66	\$9.95	
		18-0DB-SN new plastic replacement socket w/ ,6" wire	47-66	\$4.95	
		<b>Dash Bulb-wiring-to</b> replace dash bulb wiring when insulation is broken away using your original metal socket			
		18-0DB-W	47-66	\$1.75	
		<b>Dash Bulb</b>			
		18-0HB-6v smaller 7/16 head for high beam indicator		\$2.15	
		18-0HB-12V smaller 7/16 head for high beam indicator		\$1.20	
		18-0DB-6V 6 volt		\$2.25	
		18-0DB-12v 12 volt		\$1.50	
		<b>Brake – Signal Light Bulbs</b>			
		19-0179A amber / 3 CP 12 volts		\$2.25	
		19-0179 clear / 3 CP 12 volts		\$1.25	
		<b>Temp Sender</b>			
		19-0469 6 or 8 Cyl—1/2 x 14 NPT w/ gauges	56-72	\$26.95	
		<b>Dimmer Switch Plug</b>			
		3-0DS-P 3 pin plug w/ connectors	57-83		
		<b>Fuses-barrel style 1 ¼ long</b>			
		18-0003 3 amp		\$0.50	
		18-0004 4 amp		\$0.50	
		18-0005 5 amp		\$0.50	
		18-0010 10 amp		\$0.50	
		18-0015 15 amp		\$0.50	
		18-0020 20 amp		\$0.50	
		<b>Ground Strap-tin coated copper wire</b>			
		18-0170-8 8" 11 gauge w/ 3/8 eyelets		\$12.95	
		<b>Fuse Holder-accessory</b>			
		18-0987 sealed w/ hdw & fuse- note fuse size		\$5.95	
		<b>Horn Button-column mount</b>			
		18-0018 6 or 12V application		\$9.50	
		<b>Voltage Regulator w/ generator</b>			
		<b>Voltage Regulator</b>			
		18-0210-12-25 12 volt w/ 25 amp gen	47-62	\$69.95	
		18-0210-12-35 12 volt w/ 35 amp gen	47-62	\$69.95	

*Bill's Truck Shop*

Phone (905) 725-3460 / (905) 725-2022 / Fax (905) 404-2302 email: bill@billstruckshop.com

		<u>Year</u>	<u>New</u>	<u>Used</u>
	<b>Tailgate w/ handle openings</b>			
	19-3555-T	55-58	\$799.95	
	<b>Tailgate Cover – fibreglass</b>			
	19-3555-TC	55-58	Inquire	
	<b>Tailgate Recoilers</b>			
	32-0105-R Cameo gate or lift gates on Suburban each --flat band/not cable	47-59	\$114.95	
	<b>Tailgate Latch w/ handle</b>			
	19-3555-LL left side	55-58	Inquire	
	19-3555-RL right side	55-58	Inquire	
	<b>Tailgate Handle-pr</b>			
	19-3555-H chrome	55-58	\$199.95	
	<b>Tailgate Ear- for latch striker</b>			
	19-3555-E L & R same each	55-58	\$34.95	
	<b>Tailgate Cable-</b> multi-strand cable w/ crimped ball ends and recoiler bkt			
	19-3555-C pair	55-58	\$199.95	

*Bill's Truck Shop*

Phone (905) 725-3460 / (905) 725-2022 / Fax (905) 404-2302 email: bill@billstruckshop.com

	<u>Year</u>	<u>New</u>	<u>Used</u>
			
19-3555-RC	19-3556		
			
19-3556-B	19-3556-B	polishes stainless steel bolts for hinged center bumper section	
			
19-3556-S	19-3556-S	pair	\$95.00
			
19-3556-H	19-3556-H		\$79.95
			
19-3556-CS	19-3556-CS		NLA
			
19-3556-SC	19-3556-SC	around edge of fibreglass tub	\$15.95
			
19-3556-P	19-3556-P		Inquire
			
19-3556-C	19-3556-C		\$34.95
			
19-3556-BA	19-3556-BA		\$36.95

*Bill's Truck Shop*

Phone (905) 725-3460 / (905) 725-2022 / Fax (905) 404-2302 email: bill@billstruckshop.com

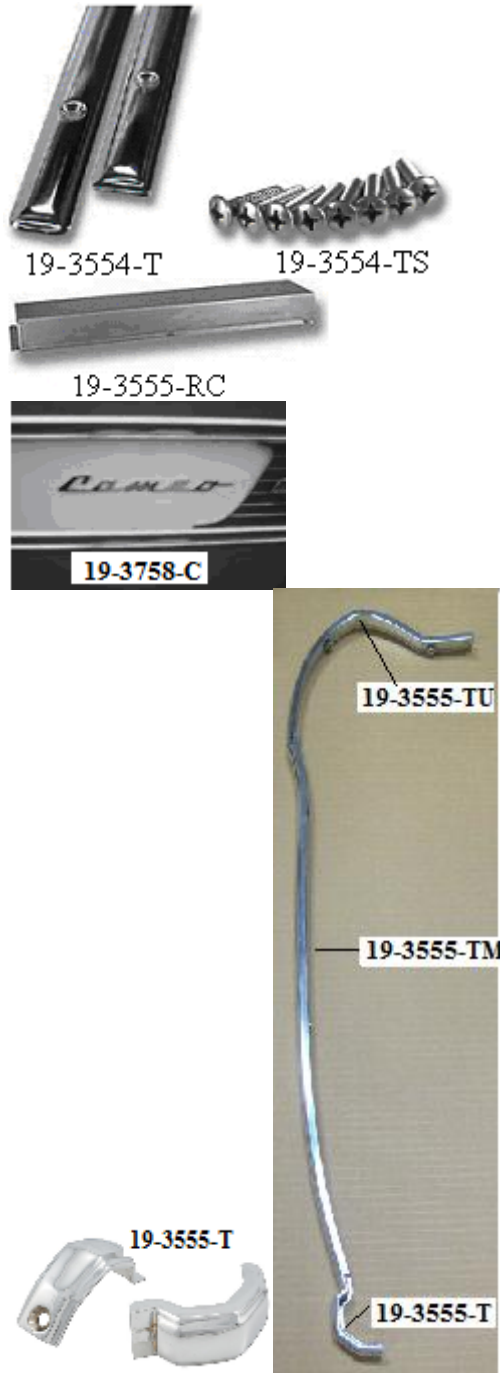

**Bedside Letters- C A M E O**

19-3758-C chromed/polished letters-set

Year      New      Used

57-58      Inquire

**Taillight Trim-** u-shaped trim below taillight-2 pc per side-smooth finish to chrome or paint

19-3760-L      left      -pair      57-58      Inquire

19-3760-R      right      -pair      57-58      Inquire

**Bedside Upper Mld-pr**

19-3554-T      55-58      Inquire

**Bedside Upper Mld Screw kit**

19-3554-TS      55-58      Inquire

Bed front side mld are made from billet aluminum and polished-sold as pairs only

**All Special Order**

**Bed Front Upper trim-pr**

19-3555-TU      55-58      Inquire

**Bed Front Middle Trim-pr**

19-3555-TM      55-58      Inquire

**Bed Front Lower Trim-pr**

19-3555-TL      55-58      Inquire



19-3540-R

**Bedsides-fibreglass outer skins**

	<u>Year</u>	<u>New</u>	<u>Used</u>
19-3540-L	55-58	\$858.00	
19-3540-R	55-58	\$858.00	

19-3542-R 19-3542-F



**Filler panel –bedside front/fibreglass**

19-3541-L	left	55-58	\$149.00
19-3541-R	right	55-58	\$149.00

19-3541-L



**Bedside Supports-secures the fibreglass sides to prevent vibration-rear is shorter then ft made in Canada**

19-3542-F	front left or right	each	55-58	\$22.95
19-3542-R	rear left or right	each	55-58	\$22.95



BTS  
EXCLUSIVE

Braces-bed side	set 5 per side			
19-3543-B	fits L & R	55-58	\$174.95	

19-3543-B



Original style	<b>made w/ 16 gauge steel</b>			
28-0354-T	Cameo-Carryall(GMC) and	54-59	\$169.95	
stepside				



28-0354-T

<b>Rear Cross Sill</b>	predrilled w/ support brackets			
30-3715-T	Cameo-Carryall(GMC) and	55-59	\$199.95	
stepside				



30-3715-T



17-303-CR



17-303-CP



19-3155-BK



17-303-CG



**Bedsides-inner**

			<u>Year</u>	<u>New</u>	<u>Used</u>
31-3397	Cameo / Suburban	left	55-58		Inquire
31-3384	Cameo / Suburban	right	55-58		Inquire
31-3557	Cameo/Suburban w/o stake pocket holes	left	55-58		Inquire
31-3558	Cameo/Suburban w/o stake pocket holes	left	55-58		Inquire

**Taillight Lens Gasket**

17-303-CG		pair	55-58		\$9.95
-----------	--	------	-------	--	--------

**Taillight Lens**

17-303-C	plastic	each	55-58		\$9.95
----------	---------	------	-------	--	--------

**Tail lamp Reflector**

17-303-CR	tail lamp lens centre reflector	each	55-58		\$23.95
-----------	---------------------------------	------	-------	--	---------

**Backup Lens**

17-303-CB	reverse lens-plastic	each	55-58		\$9.95
-----------	----------------------	------	-------	--	--------

**License Plate Light kit-pr**

17-303-CP	housing-lens-wiring		55-58		\$49.95
-----------	---------------------	--	-------	--	---------



17-303-C



17-303-CR



17-303-CB



24-315-E



19-3155-IB



19-3255-WC

**Cameo Inner Bumpers**

19-3155-IB		pair	55-58	Inquire	Inquire
------------	--	------	-------	---------	---------

**Cameo Bumper Ends triple nickel plated chrome**

19-3155-E		pair	55-58	Inquire	Inquire
-----------	--	------	-------	---------	---------

**Cameo -rear bumper bkt set**

19-3155-BK		set	55-58	Inquire	
------------	--	-----	-------	---------	--

**Trim Ring Clip**

19-3255-WC	metal clip w/ correct rubber bumper - 5 required per wheel	each	55-58		\$19.95
------------	--	------	-------	--	---------

*Bill's Truck Shop*

Phone (905) 725-3460 / (905) 725-2022 / Fax (905) 404-2302 email: bill@billstruckshop.com



**10-0204-BK**



**Armrest**

			<u>Year</u>	<u>New</u>	<u>Used</u>
10-0204-R	red w/ beige bas	each	55-65	\$59.95	
10-0204-BR	brown	each	55-65	\$59.95	
10-0204-BK	black	each	55-65	\$59.95	
10-0204-G	gray	each	55-65	\$59.95	
10-0204-BL	blue special order	each	55-65	\$69.95	
10-0204-T	turquoise special order	each	55-65	\$69.95	

correct Haircell grain vinyl w/ exact Cameo seat cloth. Cut from factory patterns and sewn to duplicate the original. Kit includes **bumper**

**kit , door panel matching cloth , & door panel back boards.**

19-3955-RI	Red & Ivory		55-58	Inquire	
19-3955-BI	Beige & Ivory		55-58	Inquire	
19-3955-BLI	Blue & Ivory		55-58	Inquire	
19-3955-CI	Charcoal & Ivory		55-58	Inquire	
19-3955-GI	Green & Ivory		55-58	Inquire	
19-3955-TI	Turquoise & Ivory		55-58	Inquire	

# Mirrors

Due to the fluctuation of the Canadian and American dollars call for current prices

# Group 20



			<u>Year</u>	<u>New</u>	<u>Used</u>
<b>Mirror Arm Painted</b>					
20-302-RP	right		55-59	\$34.95	
20-302-LP	left		55-59	\$34.95	
<b>Mirror Arm Chrome</b>					
20-303-RC	right		55-59	\$42.95	
20-303-LC	left		55-59	\$42.95	
<b>Mirror Arm Gasket w/ moulded lip</b>					
20-303-G	each		55-59	\$2.00	
<b>Mirror Arm Screw Set -R side will require nuts</b>					
13-0MS	stainless steel	set of 3	55-70	\$4.95	
13-0MS-A	OE collared style-philips drive-steel	set of 3	55-70	\$6.95	
<b>Outside Mirror Head</b>					
When setting the mirror head for viewing loosen the 3 set screws on back of head & tighten when in desired location-this prevents scratching the pivot ball and future rusting-also lube w/ grease					
20-0PM	round/ribbed/painted		47-70	\$17.95	
20-0CM	round/ribbed/chrome		47-70	\$23.95	
20-0PRM	rectangular/painted		47-70	\$24.95	
20-0SRM	rectangular/stainless		47-70	\$27.95	
<b>Peep Mirror Chrome Plated.</b>					
mirror, bracket clamps on top edge of door.					
20-0PM-C	4" w/ curved arm-chrome	L or R		\$34.95	
9-0PM-S	4" w/straight arm-chrome	L or R		\$36.95	
<b>Inside Mirror Head - Day/Night</b>					
20-0206-DN	Chrome		54-59	\$69.95	
<b>Inside Mirror Head</b>					
20-0306	Stainless Steel		54-59	\$34.95	
<b>Inside Mirror Bracket</b>					
20-306-B	w/ screws		55-59	\$31.95	
<b>Vanity Mirror w/ CHEVROLET</b>					
9-0VM	OE option	for sun visor	47-66	\$35.95	

*Bill's Truck Shop*

Phone (905) 725-3460 / (905) 725-2022 / Fax (905) 404-2302 email: bill@billstruckshop.com

# Wipers

Due to the fluctuation of the Canadian and American dollars call for current prices

# Group 21



### Electric Wiper Motor with switch & wiring-USA made-switch will accept original knob

21-301-55	2 speed	55-57	\$449.95
21-301-58	2 speed	58-59	\$449.95
21-0200	pulse wiper control 3 speed w/ washer—accepts 5-304-B bezel	47-72	\$139.95

### Bushing kit w/ new electric wiper motor

21-0001	4 replacement nylon bushing w/ washers		\$7.95
---------	--	--	--------

### Electric Wiper Motor 12V original used tested

21-301-55U	when available	55-57	\$175.00
21-301-58U	when available	58-59	\$175.00

### Wiper Knob—fit OE wiper controls only

5-304	chrome w/ 9/32 hole & set screw	55-59	\$19.95
5-304-A	black w/pentagon hole & set screw /paint white for GMC	55-59	\$9.95 \$5.00

### Wiper Switch-will not accept original knobs

5-304-B	accepts bezel 5-304-B		
21-0201-S	universal 2 speed switch w/o washers	47-58	\$23.95

### Wiper Switch Retainer/Bezel

5-304-B	fits OE & replacement switches	55-59	\$12.50
---------	--------------------------------	-------	---------

### Wiper Motor Control

21-301-E	manual control & cable w/ electric wipers	55-59	\$25.00
21-302-V	manual control & cable w/ vac wipers- 11" long cable	55-59	\$25.00
21-302-S	switch w/ electric wipers w/ 2 pin connector	58-59	\$25.00

### Wiper Motor Slider

21-302-55S	plastic control slider on electric motor	55-57	\$11.95
------------	--	-------	---------

### Wiper Motor Mount kit

21-301-MK	well nut w/ screw, washer to secure bkts to cab w/ OE wiper motors as required-	each	55-59	\$3.25
-----------	---	------	-------	--------

### Wiper Arm - Stainless Steel

21-0303-L	left	54-59	\$22.95
21-0303-R	right	54-59	\$22.95

### Wiper Blade

21-303-B	stainless steel	each	55-59	\$21.95
----------	-----------------	------	-------	---------

*Bill's Truck Shop*

Phone (905) 725-3460 / (905) 725-2022 / Fax (905) 404-2302 email: bill@billstruckshop.com

# Wipers

Due to the fluctuation of the Canadian and American dollars call for current prices

# Group 21

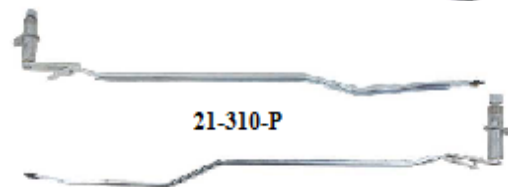

21-0206-VH



13/16

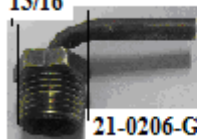

21-0206-F



21-0206-H



## Wiper to Cowl Bezels

21-305-B chrome pair 55-59 \$38.95

## Wiper to Cowl Bezel Gaskets

21-305-G installs under dash @ transmission pair 55-59 \$3.95

## Washer Nozzles

21-305-WN pair 55-59 \$6.50

## Wiper Bezel Nuts

21-0205-N pair 47-59 \$8.95

## Wiper Transmission Arm Grommets

21-309 for 58/59 w/ electric wipers pair 58-59 \$2.50

## Wiper Transmission Arm Retainer & Spring

21-0209-1 54-59 4.50

## Wiper Transmission Arm and Pivot

21-310-L. left 55-59 \$75.00

21-310-R right 55-59 \$75.00

21-310-P pair 55-59 \$225.00

## Vacuum Hose -vacuum wiper to engine outlet

21-0206-VH 3' 7/32 dia hose 47-59 \$2.00

## Vac Outlet on Intake Manifold

21-0206-F brass 90 deg -----3/8 OD 47-59 \$8.95 \$5.00

21-0206-G brass 90 deg----- 13/16 OD \$8.00

21-0206-H brass 90 deg -----13/16 OD---pr 47-59 \$14.50

## Windshield Washer Pump

21-0211-U Electric (universal) \$38.95

*Bill's Truck Shop*

Phone (905) 725-3460 / (905) 725-2022 / Fax (905) 404-2302 email: bill@billstruckshop.com

Please pay close attention when ordering heater parts- there seams to be at least 4 different types/designs of heater in Chev & GMC trucks – we have added some pictures

Year      New      Used

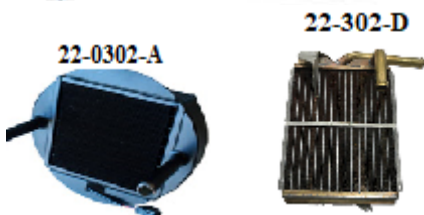
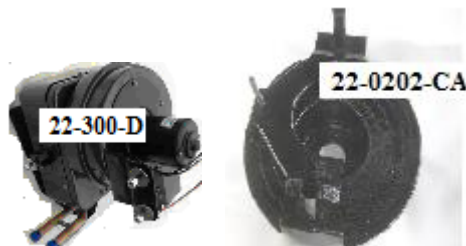
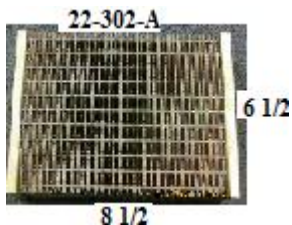

**Heater Core-NEW copper cores ONLY -US made Chev and GMC application**

22-302-A	approx 8 1/2 long x 6 1/2 wide-core only	55-59	Inquire
22-302-B	approx 7 long x 6 1/2 wide-core only	55-59	Inquire
22-302-S	standard heater includes end support bkts- 8 3/4 x 6 3/4 x 3 1/4 tube spacing/90 deg-----NEW CORE	55-59	Inquire
22-302-S-R	rebuilt std heater includes end support bkts- 8 3/4 x 6 3/4 x 3 1/4 tube spacing/ 90deg <b>Repaired OE unit</b>	55-59	Inquire
22-302 -D	dlx heater core-includes water valve support- 7 1/2 x 6 3/4 x 2 3/4 <b>NEW copper/brass CORE</b>	55-59	\$299.00
22-302-D-R	rebuilt dlx heater-includes water valve support 7 1/2 x 6 3/4 x 2 3/4 <b>Repaired OE unit</b>	55-59	NLA

**Heater Core Assembly w /12v motor**

22-0302-A	replacement assembly w/ 12 V motor –new square core w/ round tanks- must install support from old assembly	47-57	\$449.95
-----------	--	-------	----------

**Heater Core Assembly (copper) w/ 11/16 pipe outlets**

22-0202-CA	round assembly- no motor	47-57	\$389.95
------------	--------------------------	-------	----------

*Bill's Truck Shop*

Phone (905) 725-3460 / (905) 725-2022 / Fax (905) 404-2302 email: bill@billstruckshop.com



22-310-L



22-0209

22-306-DP-G 22-305-DP-G



23-301-C



22-0201

### Defroster Outlets

22-310-L	original steel	55-59	\$25.00
22-310-R	original steel	55-59	\$25.00
22-310-P	ABS plastic- fits L o R each	55-59	\$34.95

### Defroster Duct Hose-OE cloth style

22-0209	2" x40"	54-63	\$54.95
22-0209-P	plastic 2"	54-63	\$32.95

### Heater Delete Plate-dash

22-305-DP-C	Chev	55-59	\$25.00
22-306-DP-G	GMC	55-59	\$25.00

### Deluxe Heater Side Delete Plate

22-301-C	at right side kick panel w/ screws	55-59	\$10.00
----------	------------------------------------	-------	---------

### Heater Accessory Kit

22-0201	a compact 12 volt replacement-includes switch & cable operated defrost -does not include hose & vents 5/8 pipe outlets-2" defrost outlets -add-defrost hose #4-0051P & grommet # 18-310-G x2---use 5/8 heater hose		\$289.95
---------	--	--	----------



# Heater

Due to the fluctuation of the Canadian and American dollars call for current prices

# Group 22

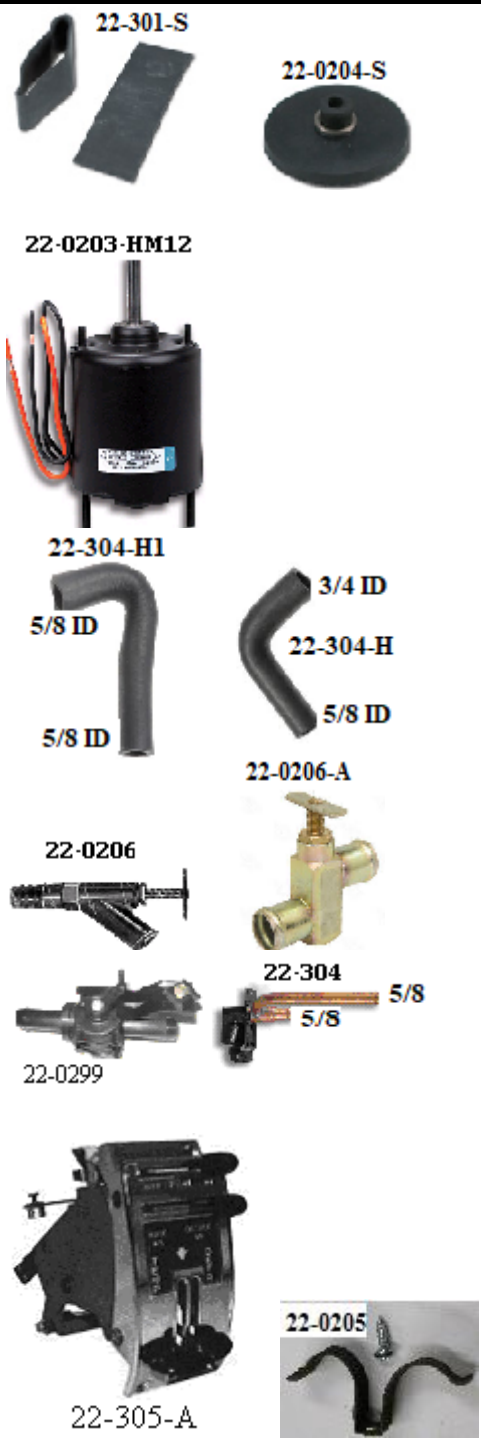

Please pay close attention when ordering heater parts- there seams to be at least 4 different types/designs of heater in Chev & GMC trucks – we have added some pictures

### Deluxe Heater Bands -heater box to side panel housing

	Year	New	Used
22-301-S w/ Deluxe/ Fresh air heaters	55-59	\$8.95	

### Heater Motor- may require drilling new stud mount holes

22-0759-12V 12 V motor for round style heater cores w/ 1/4 inch dia shaft-2 5/16 stud -3.75 body length- 2 way rotation	47-59	\$124.95	
---	-------	----------	--

### Recirculating Heater includes 5/16 shaft adapter sleeve

22-0203-HM12 12 V motor for rectangular heater w 5/16 shaft -mount bolt spacing 2 5/16---3 5/16 " body length 2 wire for rev or forward rotation all w/ Deluxe/ Fresh air heaters	47-66	\$99.95	
---	-------	---------	--

### Dlx Heater Control Valve

22-304 55-56 w/ deluxe heater with 5/8 tube & will also work on 57 to 59	55-59	\$159.95	
--	-------	----------	--

### Dlx Heater Control Valve Hose-check heater core pipe size for water valve

22-304-H 5/8 & 3/4 ID ends- curved hose @ valve	55-59	\$22.95	
22-304-H1 5/8 & 5/8 ID ends curved hose	55-59	\$16.95	

### Heater Control Valve Seal

22-0204-S Ranco valve seal	47-63	\$22.95	
----------------------------	-------	---------	--

### Water Control Valve

22-0299 heater hose-manual control water valve -pull to open 5/8 by 5/8 hose dia- can use 55-59 (T) throttle cable to operate	47-87	\$42.95	
---	-------	---------	--

### Heater Hose Water Shut-off Valve-manual

22-0206 5/8 hose to 3/8 pipe	37-62	\$49.95	
22-0206-A 5/8 in 5/8 out	37-62	\$34.95	

### Heater Hose Retainer w/ screw

22-0205 original used- on pass inner fender	40-59		\$5.00
---	-------	--	--------

### Heater Hose

Accel			
18-0401 5/8 black-per foot		\$2.00	
18-0402 3/4 black-per foot		\$2.00	

### Heater Control Assembly/dlx -complete w/ levers & switch

22-305-A Chev	55-59	\$349.95	
22-306-A GMC	55-59		Inquire

## Bill's Truck Shop

Phone (905) 725-3460 / (905) 725-2022 / Fax (905) 404-2302 email: bill@billstruckshop.com

# Heater

Due to the fluctuation of the Canadian and American dollars call for current prices

# Group 22



			Year	New	Used
<b>Heater Control Bezel</b> chrome					
22-305-B	Chev		55-59	\$69.95	
22-305-B-G	GMC		55-59		inquire
<b>Heater Backing Plate - for lens</b>					
22-305-P	black -Chev only		55-59	\$3.50	
22-305-GP	black-GMC only		55-59		inquire
<b>Heater Control Lens Face</b>					
22-305-DL	Chev only		55-59	\$19.95	
22-305-GL	GMC only		55-59		
<b>Heater Switch</b>					
22-305-S	rotary OE style w/ standard heater w/ black knob-accepts OE chrome knob---2 speed		55-59	\$54.95	
22-305-D	deluxe heater		55-59	\$44.95	
22-205-12V	universal w/ lighted control 10 amp/ 12 volt		47-59	\$24.95	
<b>Heater Switch Screws</b>					
22-305-SS	screws to secure switch to housing w/ dlx heater	pr	55-59	\$2.00	
<b>Heater Levers-----vertical levers only</b>					
22-305-L	Chev	pair	55-59	\$38.95	
22-306-L	GMC	pair	55-59	\$59.95	
<b>Heater Knobs</b>					
22-305-K	w/ deluxe heater 4 pcs black	Chev-GMC	55-59	\$12.50	
22-305-KG	w / deluxe heater 4 pcs/ correct	white knobs found on GMC trucks NEW ITEM!!	55-59	\$34.95	
36-309	w/std heaters -chrome w/ 3-1/16 hole &set screw		55-59	\$18.95	
<b>Heater Cables</b> for deluxe heater					
22-305-C	Chev		55-59	\$49.95	
22-306-G	GMC		55-59	\$49.95	
<b>Heater Cable Retainers</b>					
4-0085-K		3 pc	47-87	\$0.75	
<b>Heater Motor Wire Grommet</b>					
22-302-G	@ front housing w/ recirculating heater		55-59	\$2.50	
<b>Heater Wiring Harness, Deluxe</b>					
22-312-H			55-59	\$39.95	
<b>Heater Decal /Defroster Decal</b>					
22-313	for standard recirculating heater		55-59	\$8.95	
<b>Manual Defroster Lever Decal</b>					
22-0212	fresh air & recirculating heater		47-59	\$3.95	

*Bill's Truck Shop*

Phone (905) 725-3460 / (905) 725-2022 / Fax (905) 404-2302 email: bill@billstruckshop.com

4-0550-K



**AC O-Ring kit**

4-0550-K \$14.95  
Hurricane Heat Cool & Defrost Unit, Deluxe Control, Wire Harness, Electric Bypass Heater valve, Expansion Valve, Duct Hose, Louvers, Plastic Glove Box, Mounting Brackets and Necessary Hardware. Inquire

**AC w/ heater kits-mounts in original heater location—due to the many engine options today call for information & pricing**

-may require upgrade to electric fan & shroud to increase cooling output  
-Chev & GMC have diff dash design-picture shows Chev w/ dlx in dash control

**Kits-** can be purchased w/ or w/ comp & bkts  
Chev—w/ electronic or manual control in or under dash

---- engine size & comp location

GMC—w/ electronic under dash control



4-0054P

**AC & Defrost hose**

- |         |                           |             |         |
|---------|---------------------------|-------------|---------|
| 4-0051P | Plastic AC & defrost hose | 6' x 2"     | \$34.95 |
| 4-0053P | Plastic AC & defrost hose | 6' x 2 1/2" | \$34.95 |
| 4-0054P | Plastic AC & defrost hose | 6' x 3"     | \$34.95 |
| 4-0055P | Plastic AC & defrost hose | 6' x 3 1/2" | \$34.95 |
| 4-0056C | Cloth AC & defrost hose   | 6' x 3 1/4" | \$99.50 |

*Bill's Truck Shop*

Phone (905) 725-3460 / (905) 725-2022 / Fax (905) 404-2302 email: [bill@billstruckshop.com](mailto:bill@billstruckshop.com)



# Hood-Fender Emblem

Due to the fluctuation of the Canadian and American dollars call for current prices

# Group 23

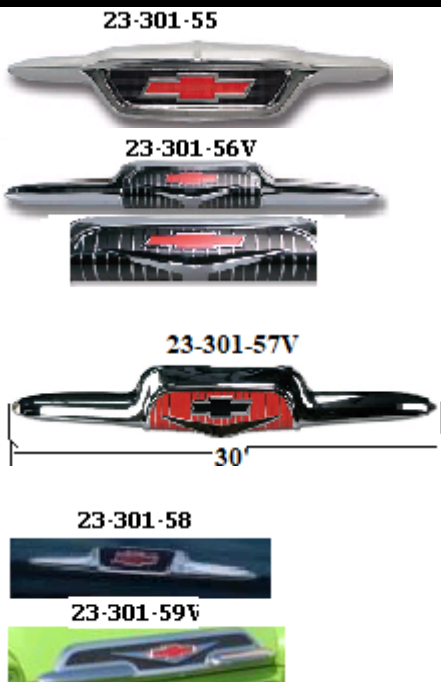

## HOOD EMBLEM-Front

### Chev

		<u>Year</u>	<u>New</u>	<u>Used</u>
23-301-55	chrome w / black painted details & red bowtie	55-55	\$389.95	Inquire
23-301-55V	chrome w / black painted details & red bowtie w / V eight	55-55	NA	Inquire
23-301-56		56-56		Inquire
23-301-56V	chrome w/ <b>black details &amp; red painted bowtie</b> w / v eight	56-56	\$349.95	Inquire
23-301-57V	chrome w/ <b>red painted details &amp; black bowtie</b> w / v eight	57-57	\$399.95	Inquire
23-301-58		58-58		Inquire
23-301-58V	for V8 trucks	58-58		Inquire
23-301-59		59-59		Inquire
23-301-59V	for V 8 trucks	59-59		Inquire

## Fender Emblem

3100 for US & 1300 for Canada built trucks

23-302-55	3100 chrome w/ white details	pair	55-55	\$489.95	Inquire
23-302-55-A	1300	<i>Canadian production</i>	55-55		Inquire
23-302-56	3100 chrome w/ black details	4 pc set	56-56	\$439.95	Inquire
23-302-56-A	1300	<i>Canadian production</i>	56-56		Inquire
23-302-57	3100 chrome w/ red details	pair	57-57	\$309.95	Inquire
23-302-57-A	1300	<i>Canadian production</i>	57-57		Inquire
23-302-57C	3124 chrome w/ red details/ Cameo	pair	57-57	\$459.95	Inquire
23-302-58	3100		58-58		Inquire
23-302-58-A	1300	<i>Canadian production</i>	58-58		Inquire
23-302-59	3100		59-59		Inquire
23-302-59-A	1300	<i>Canadian production</i>	59-59		Inquire

*Inquire for any other emblems.*

## Bill's Truck Shop

Phone (905) 725-3460 / (905) 725-2022 / Fax (905) 404-2302 email: bill@billstruckshop.com

# HOOD-FENDER EMBLEMS

# GROUP 23



### Bed Side Emblems-FLEETSIDE

23-310-58 w/ hdw made in USA each 58-59 \$89.95



Emblem Fasten 8 x 10-24x1 studs & 8 high dome nuts 16 pcs 47-59 \$12.95  
23-0727



### Hood Ornament – rockets

23-308-55 die cast/chrome bird 55-56 \$375.00  
23-308-57 die-cast/chrome hood rockets pair 57-57 \$949.95



### Hydramatic Emblem

23-304-57 on doors for automatic trucks pair 57-57 \$29.95



### Fender / Door Emblem for V8

23-306-55 V8 on fender pair 55-56 \$74.95  
23-306-57 on door pair 57-57 \$48.00



### Napco Emblem

23-0344 hood & fender each 51-59 \$114.95



### Napco Dash Plate-shift pattern

23-0345 metal plate on dash 54-59 \$39.95



# Grills- Trim

Due to the fluctuation of the Canadian and American dollars call for current prices

# Group 24

	<u>Year</u>	<u>New</u>	<u>Used</u>
GMC Grill			
GMC grill /eyebrows/ bullets/mls			inquire

## Bill's Truck Shop

Phone (905) 725-3460 / (905) 725-2022 / Fax (905) 404-2302 email: [bill@billstruckshop.com](mailto:bill@billstruckshop.com)



1957 GMC 9600



# Grills- Trim

Due to the fluctuation of the Canadian and American dollars call for current prices

# Group 24



CHEV	Grill	Year	New	Used
24-301-55	chrome	55-56	\$699.95	Inquire
24-301-55P	chrome painted	55-56	\$550.00	Inquire
24-301-57	chrome	57-57	\$1099.95	5 Inquire
24-301-57P	white	57-57	\$849.95	Inquire
24-301-58	chrome w/black accent letters	58-59	\$699.95	Inquire
24-301-58P	chrome painted	58-59		Inquire
<b>Headlamp Bezels w/ screws</b>				
16-355-B	chrome w/ seals	pair 55-57	\$179.95	\$60.00
16-355-B-P	OE used painted	pair 55-57		\$60.00
16-358-B	chrome	pair 58-59	\$149.95	\$60.00
16-358-B-W	OE used white	pair 58-59		\$60.00
<b>Grill Hardware Install kit</b>				
24-301-55K	to install grille	12 pcs - Chev only	55-56	\$17.95
24-301-57K	to install grille	17 pcs- Chev only	57-57	\$12.95
24-301-58K	to install grille	8 pcs-Chev & GMC	58-59	\$12.95
<b>Grille-supports to grille- outer &amp; inner</b>				
24-301-58SK	12 screws w/nuts		58.59	\$2.95
<b>Headlight Bezel Screws= stainless steel</b>				
16-355-S		6 pcs	55-57	\$2.50
16-358-S		8 pcs	58-59	\$2.00
<b>Headlamp Bezel Seals w/ wire core as original</b>				
16-0207-1		pair	47-57	\$19.95
<b>Grill Decals</b>				
24-302-58B		black	58-59	\$7.95
24-302-58W		white	58-59	\$7.95

## Bill's Truck Shop

Phone (905) 725-3460 / (905) 725-2022 / Fax (905) 404-2302 email: bill@billstruckshop.com

# Grills- Trim

Due to the fluctuation of the Canadian and American dollars call for current prices

# Group 24

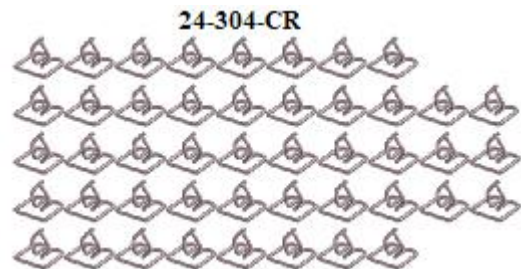
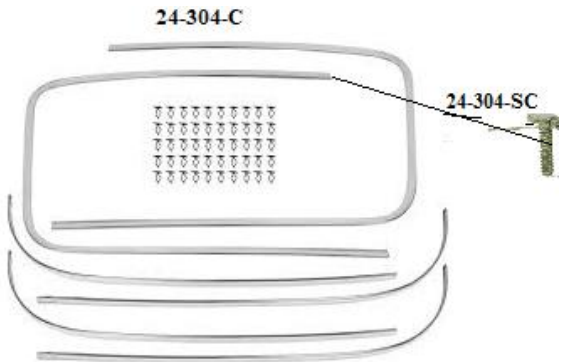

<b>Cab Trim</b>	<i>inquire on individual used pcs</i>			
24-304-C	stainless steel w/clips- deluxe cab	55-59	\$224.95	
<b>INDIVIDUAL PIECES NEW-</b>				
<b>INQUIRE</b>				
24-304-LD	left door	55-59		Inquire
24-304-RD	right door	55-59		Inquire
24-304-LU	rear cab upper left	55-59		Inquire
24-304-RU	rear cab upper right	55-59		Inquire
24-304-LL	rear cab lower right	55-59		Inquire
24-304-RL	rear cab lower right	55-59		Inquire
24-304-CR	clip kit for cab trim –fits OE trim holes only ( NO water seal on clip)	50 piece kit	55-59	\$22.95
24-304-C1	push in spring clip	each	55-59	\$0.50
24-304-SC	nut on clip & door end upper	each	55-59	\$5.50

## Bill's Truck Shop

Phone (905) 725-3460 / (905) 725-2022 / Fax (905) 404-2302 email: bill@billstruckshop.com

24-3156

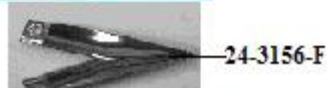
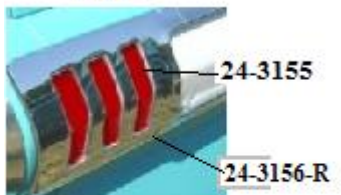

**BTS exclusive**

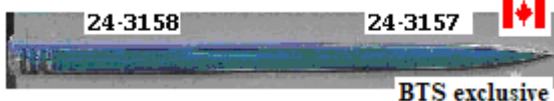

**Bed Trim Decal**

24-3155 bright red reflective decal behind underneath rear trim mld set 58-59 \$11.95

**Bed Mld End Trim set-4pc**

24-3156 end pcs for short/long bed truck w/ stainless mld-chrome die cast w/ red decals 58-59 \$449.95  
 24-3156-F front spear w/ hdw each 58-59 \$45.00  
 24-3156-R rear chevron w/ hdw each 58-59 \$150.00

**Hardware kit-bed mld end trim**

24-3156-K washers, spacers, nuts & screws to install chrome end pcs 58-59 \$12.95

**Bed Mlds** beautiful stainless steel (436) mlds - upper is the same as lower on opposite side **made in Canada** available for long & short bed sold as each —check our website gallery for pictures of these trucks w/ our mlds installed short are 68" long – original short have 9 holes & long have 9 per mld- when installing for the 1<sup>st</sup> time we recommend 5 holes- 2 nut on in wheel arch area and 3 push in outward

View our website gallery 1955-59 and see some trucks w/ our mlds **NEW PRICE**

24-3157 upper left also fits lower right **short bed** each 58-59 \$175.00  
 24-3158 upper right also fits lower left **short bed** each 58-59 \$175.00  
 24-3159 upper left also fits lower right **long bed** each 58-59 \$175.00  
 24-3160 upper right also fits lower left **long bed** each 58-59 \$175.00

**Mld Retainers** as required

24-3000 (5/16--.3125 hole ) push in clip each 58-59 \$2.95  
 24-3001 nut on clip w /hdw each 58-59 \$2.95

**Bed Side Emblems-FLEETSIDE**

23-310-58 w/ hdw made in USA each 58-59 \$89.95

**Emblem Fastener kit**

23-0727 8 x 10-24x1 studs & 8 high dome nuts 16 :pcs 47-59 \$11.95

*Bill's Truck Shop*

Phone (905) 725-3460 / (905) 725-2022 / Fax (905) 404-2302 email: bill@billstruckshop.com



# Rims-Hubcaps-Trim Rings

# Group 24



24-305-55

24-0305-57

24-0205-S



24-306-55

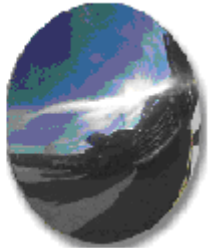

24-007-15S



24-007-15R



24-007-16R



24-0201-15

## Hubcaps

Year    New    Used

### Chevy fits 15 and 16 clip style rims

24-305-55 chrome w/ Bombay Ivory painted details-each 55-56 \$129.95

24-0305-57 chrome w/ black painted details each 57-60 \$119.95

### GMC fits 15 and 16 clip style rims

24-306-55G chrome w/ red painted details -each 55-59 \$109.95

### Smooth- Baby Moon style

24-0205-S stainless steel/smooth---w/ clip styles wheels only each \$79.95

24-0205-8 chrome/smooth ---fit outside ear wheels only 10 1/8 OD chrome \$36.95

### Full Wheel Covers -Cameo & deluxe trucks

24-307-C full stainless steel w/ painted details each 55-55 Inquire

### Deluxe Wheel Beauty Ring

24-307-TR 3' wide chrome ring w/ out black lines - used on 55-56 trucks but will fit 57-59 set of 4 - 15" 55-56 \$90.00

### Dlx Wheel Cover Retainers

24-307-R (20) 55-55 \$85.00

### Beauty Ring (stainless steel)

24-007-15S 15 inch w/ smooth face each 47-87 \$39.95

24-007-15R 15-inch w/ ribbed face each 47-87 \$39.95

24-007-16S 16 inch w/ smooth face each 47-87 \$39.95

24-007-16R 16 inch w/ ribbed face each 47-87 \$39.95

### Moon Hub Caps—Salt Flat style

24-0201-15 15 " wheels brushed stainless steel each \$27.95

## Bill's Truck Shop

Phone (905) 725-3460 / (905) 725-2022 / Fax (905) 404-2302 email: bill@billstruckshop.com

# Rims-Hubcaps-Trim Rings

# Group 24

Used



Rims Original Style used southern clip wheels

15 -16 " wheels    4 – 4 ½-5 – 5 ½ -6    width    47-62    \$75.00



Wheel Clips each w/ hdw

Clips for retaining original type hubcaps.	each		
24-0905-15            for 15 & 16 ' 6 stud rims		37-62	\$4.50
24-0905-15K        for 15& 16" 6 stud rim set 5 w/ hdw		37-62	\$19.95
24-0905-17            for 15-16-17 up 8 stud in rims & up		47-62	\$5.00

approx 1 15/16 tall  
15& 16 " 8 stud clips



**Diameter**

Rim diameter is measured from tire bead seat area to tire bead seat area



**Width**

Rim width is measured from tire bead seat area to tire bead seat area

*Bill's Truck Shop*

Phone (905) 725-3460 / (905) 725-2022 / Fax (905) 404-2302 email: bill@billstruckshop.com

# Bumpers-Brackets

Due to the fluctuation of the Canadian and American dollars call for current prices

# Group 24



**Bumpers** –Premium Quality – triple nickel plated, and then chromed to a mirror finish -Ft bumpers require drilling for GMC trucks

Front bumpers also fit rear panel or sub

24-314-FC front chrome and 55-59 panel/suburban rear **w/o plate bkt holes**

24-314-FC-58 correct for 58-59 w/ licence bkt holes **NEW item !!**

24-314-FP front painted

24-314-RC rear chrome stepside

24-314-RP rear painted stepside

24-314-RFC rear chrome fleetside

24-314-RFP rear painted fleetside

**Bumper Bolts** w/ hardware

1-0BBC chrome w/. High dome head each

1-0BBS stainless steel capped each

1-0BBP **BLACK NEW ITEM** each

**Bumper Bracket Kit Front** w/ hardware

24-316-F55 inner & outer

24-316-F55-L outer left

24-316-F55-R outer right

24-316-F58 inner & outer

34-316-F58-L outer left

34-316-F58-R outer right

24-316-F inner – pair

24-316-RSP suburban/panel outer bkts- pair

**Bumper Bracket Kit Rear** w/ hardware

24-316-RS inner & outer stepside

24-316-RF inner & outer fleetside

24-316-C inner & outer Cameo

24-316-SP suburb/panel rear outer pair

**Bumper Guards**

Stamped steel, chrome plated with hardware.

24-317 pair

**License Plate Bracket & Lamp Assembly**

18-303-S stepside

18-0303-F fleetside-mounts to bumper

18-0812 plate bracket Bolt kit

18-0303-L plate light lens

18-0303-G plate light lens gasket

Year New Used

55-59 \$379.95 Inquire

Inquire

58-59

55-59

\$299.95

Inquire

55-59

\$359.95

Inquire

55-59

\$299.95

Inquire

58-59

\$359.95

Inquire

58-59

\$299.95

Inquire

47-72

\$5.95

47-72

\$5.95

47-72

\$6.50

55-57

\$159.95

55-57

\$25.00

55-57

\$25.00

58-59

\$159.95

58-59

\$25.00

58-59

\$25.00

55-59

\$40.00

55-59

\$139.95

58-59

\$189.95

55-58

Inquire

55-59

\$79.95

55-59

\$199.95

54-59

\$45.95

58-66

\$57.95

58-66

\$4.50

58-66

\$9.95

58-66

\$1.50

*Bill's Truck Shop*

Phone (905) 725-3460 / (905) 725-2022 / Fax (905) 404-2302 email: bill@billstruckshop.com

# Filler Panels-Grille Bars-Plate Bracket

# Group 25



25-301-55



25-302-55



25-301-57



25-302-57



25-301-58



25-301-58S



25-303-55



25-303-58

## Front Splash Apron / Bumper Filler/Lower Grille

**Bar** below grille behind bumper NEW  
PRICE!!!

				<u>New</u>	<u>Used</u>
25-301-55	(w/ grille supports)	Chev	55-56	\$179.95	\$75.00
25-301-57	(w/o grille supports)	Chev	55-57	\$169.95	\$75.00
25-301-55G		GMC	55-57		\$100.00
25-301-58		Chev & GMC	58-59	\$144.95	\$75.00

## Supports- lower splash apron

25-301-58S	L or R		58-59		\$25.00
------------	--------	--	-------	--	---------

## Upper Grill Bar

25-302-55		Chev	55-56	\$119.95	\$50.00
25-302-57	recessed at grille mount holes	Chev	57-57	\$119.95	\$50.00
25-302-55G		GMC	55-57		Inquire
25-302-58G		GMC	58-59		Inquire

## Front License Bracket

25-303-55	mounts on right side lower valance				
Chev - black			55-57	\$15.95	
25-303-55-G	requires using 58-59 Chev and drilling the bumper	GMC	55-57	NLA	
25-303-58	black	Chev & GMC	58-59	\$24.95	
25-303-58SS	stainless steel /	Chev & GMC	58-59	Inquire	

*Bill's Truck Shop*

Phone (905) 725-3460 / (905) 725-2022 / Fax (905) 404-2302 email: bill@billstruckshop.com

# Bed Wood & Bed Strips

Due to the fluctuation of the Canadian and American dollars call for current prices

# Group 26

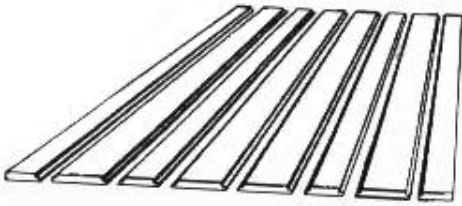

**Wood**-Cut to size with edges grooved, sanded and ready to finish, ----not drilled for mounting holes-3/4 kilned dried boards

## red oak

		<u>Year</u>	<u>New</u>	<u>Used</u>
26-0238	short step	54-59	\$724.95	
26-0252	long step 89"	54-57	\$759.95	
26-3254	long step 97"	57-59	Inquire	
26-0433	long step - 1 ton 107 1/4"	54-59	Inquire	
26-3260	short fleetside	58-59	\$769.95	
26-3264	long fleetside	58-59	\$949.95	

## Yellow Pine

26-0239	short step	54-59	Inquire	
26-3173	short step w/ predrilled mounting holes	55-59	Inquire	
26-0253	long step 89"	54-57	Inquire	
26-3255	long step 97"	57-59	Inquire	
26-0359	long step-1 ton 107 1/4"	54-59	Inquire	
26-3261	short fleet	58-59	Inquire	
26-3265	long fleet	58-59	Inquire	

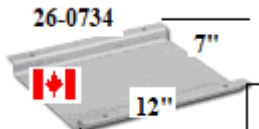

**Heat Shield** -to shield exhaust (tailpipe) on wood floor over rear axle-prevents wood from burning

26-0734	includes hdw	each	47-72	\$16.95
---------	--------------	------	-------	---------

## Bill's Truck Shop

Phone (905) 725-3460 / (905) 725-2022 / Fax (905) 404-2302 email: bill@billstruckshop.com



# Bed Strips

Due to the fluctuation of the Canadian and American dollars call for current prices

# Group 26



Custom Bed Strips w/ hidden fasteners



**Bed Strips** – each strip is 1 ½” wide & made of 18 gage material. Stainless steel strips are #430 bright stainless and polished to a beautiful finish. Pre-punched w/ square holes for correct application. Can also order special lengths & hole location- **BS**=bed strips 7 strips required

**Steel**

		<u>Year</u>	<u>New</u>	<u>Used</u>
26-0018	short step	54-59	\$149.95	
26-0018-A	short step-each	54-59		
26-3048	long step 89"	55-57	\$179.95	
26-3051	long step 97"	57-59	\$179.95	
26-0684	1 ton long step 107" 7 pcs	54-59	\$199.95	
26-3084	long fleetside	58-59	\$189.95	
26-3072	short fleetside	58-59	\$179.95	

**Polished Stainless Steel**

26-0016	short step	54-59	\$299.95	
26-0016-A	short step- each strip	54-59	\$44.95	
26-0434	1 ton long step 107 " 7pcs	54-59	\$339.95	
26-3046	long stepside 89"	55-57	\$319.95	
26-3049	long stepside 97"	57-59	\$359.95	
26-3082	long fleetside	58-59	\$469.95	
26-3070	short fleetside	58-59	\$399.95	

**Custom "WOW" Bed Strips w/ hidden fasteners**

**Polished Stainless Steel:** custom strips w/ "T" type bolt slides on bottom of strip

26-0095	"T" bolts w/ h/w as required –short bed requires 7	each	\$6.00	
26-0083	97 " long - cut to fit	each	\$99.00	

**Bed Strip Kit**

7 strips 82 " w/ 49 "T" bolts and angle side h/w				
26-0083-K			\$699.95	

**Stainless Steel w/ o holes**

26-0634	78 " long PST w/o holes	each	\$44.95	
26-0160	89 " long PST w/o holes	each	\$59.95	
26-0336	120" long PST w/o holes	each	\$84.95	

**Steel w/ o holes**

26-0007	77 1/8 long w/o holes	each	\$29.95	
26-0008	97 " long w/o holes	each	\$39.95	
26-0383	120" long w/o holes	each	\$59.95	

When installing the bed and angle strip bolts do not over tighten-collapse the lock washer only - the bed strips will collapse when they are over tightened

## Bill's Truck Shop

Phone (905) 725-3460 / (905) 725-2022 / Fax (905) 404-2302 email: bill@billstruckshop.com

# Angle Strips

Due to the fluctuation of the Canadian and American dollars call for current prices

# Group 27



Year      New      Used

## Angle Strips

Angle strips are pre-punched with 5/16 holes & can be spot welded or bolted to the sides (pair)

### Steel

27-0114	short stepside	54-59	\$74.95
27-3138	long stepside 89"	55-57	\$94.95
27-3147	long stepside 97"	57-59	\$94.95
27-0140	long stepside 1 ton	54-59	\$94.95

### Polished Stainless Steel

27-0112	short stepside	54-59	\$119.95
27-3136	long stepside 89"	55-57	\$129.75
27-3145	long stepside 97"	57-59	\$149.75
27-0437	long stepside 1 ton	54-59	\$159.95

## Angle Covers

Used to cover the original angle strips on sides can be bolted or welded to the sides. Must pre-drill holes.

### Steel (pair)

27-0139	97 " long		\$69.95
---------	-----------	--	---------

## Bill's Truck Shop

Phone (905) 725-3460 / (905) 725-2022 / Fax (905) 404-2302 email: bill@billstruckshop.com

# Bed Bolt Kits

Due to the fluctuation of the Canadian and American dollars call for current prices

# Group 28

Year      New      Used

Kits include all bolts, nuts, washers to secure angles & strips plus to mount bed to frame

### Zinc-bolt kit

28-3359	short stepside	55-59	\$89.95
28-3523	long stepside 89"long	55-57	\$89.95
28-3290	long stepside 97" long	57-59	\$89.95
28-0358	1 ton long step 107" long	54-59	\$99.95



28-3314	long fleetside	58-59	\$109.95
28-3305	short fleetside	58-59	\$94.95

### Polished Stainless Steel -bolt kit

28-3357	short stepside	55-59	\$199.95
28-3521	long stepside 89" long	55-57	\$199.95
28-3288	long stepside 97" long	57-59	\$199.95
28-0439	1 ton long step 107 "long	54-59	\$199.95
28-3769	cameo & suburban	55-58	\$289.95
28-3312	long fleetside	58-59	\$259.95
28-3303	short fleetside	58-59	\$209.95

**Bed to Frame Kits w/ bolts, nuts & off-set washers-this is included with bed bolt kits**

### Zinc

28-0432	long stepside 89" long	54-57	\$35.00
28-3420	short stepside	55-59	\$34.95
28-3496	long stepside 97 ' long	57-59	\$35.00
28-3488	cameo & suburban	55-58	\$39.95
28-3457	long fleetside	58-59	\$41.50

### Polished

28-3455	long fleetside	58-59	\$89.95
28-3446	short fleetside	58-59	\$89.95
28-3418	short stepside	55-59	\$89.95

### Bed Strips & Angles only bolt kit

Use this kit when hiding bed to frame bolts under your boards

28-0346	short step	54-59	\$94.95
---------	------------	-------	---------

### Washer

28-0211	off-set washer-stainless steel 1 1/2 OD w/ 7/16 square hole	34-72	\$12.95
---------	---	-------	---------

**bolts through bed sills only-dome bottom of boards- for the clean floor look**



**28-0211**



## Bill's Truck Shop

Phone (905) 725-3460 / (905) 725-2022 / Fax (905) 404-2302 email: bill@billstruckshop.com

# Bed Parts

Due to the fluctuation of the Canadian and American dollars call for current prices

# Group 28



28-0354-T



28-3119



28-3WT

shows assembled box



21-0402-FK

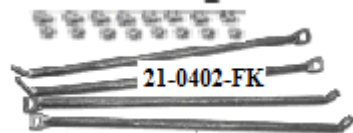

US parts not primed-Overseas parts black primer

### Front Bed Panel

		Year	New	Used
<b>Original style</b>	made w/ 16 gauge steel			
28-0354-T	stepside made in Taiwan	54-59	\$169.95	
28-3119-T	fleetside-made in Taiwan	58-59	\$349.95	
<b>Embossed</b>	with Chevy Bowtie			
28-0696	stepside made in US	54-59	Inquire	

### Front Bed Panel Mounting Bolts

#### Steel

23-0387-S	Cap screw style steel---step & fleetside	54-72	\$11.95	
-----------	--	-------	---------	--

#### Stainless Steel

23-0387-SS	Phillips head stain-steel / step & fleet	54-72	\$19.95	
------------	--	-------	---------	--

### Wheel Tubs

28-3WT	fleetside wheel tubs-each	58-59	\$219.95	
--------	---------------------------	-------	----------	--

### Bed Sides

28-3063	short fleet- left	58-59	\$1599.95	
28-3064	short fleet-right	58-59	\$1599.95	

### Braces-bed side to cross sill

21-0402-FK	set of 4 w/ hdw STEEL fleetside beds	58-66	\$89.95	
	Can be purchased EACH left or right side front or rear		\$20.00	
21-0402-FK-C	set of 4 w/ hdw CHROME fleetside beds	58-66	\$109.95	

Due to the fluctuation of the Canadian and American dollars call for current prices

## Bill's Truck Shop

Phone (905) 725-3460 / (905) 725-2022 / Fax (905) 404-2302 email: bill@billstruckshop.com

# Tailgates

Due to the fluctuation of the Canadian and American dollars call for current prices

## Group 29



21-0566-C  
23-0SGMC-A

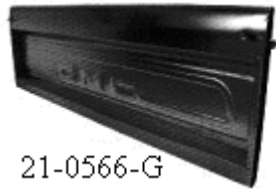

21-0566-G



23-0SBLANK



23-0682

### STEPSIDE / FLEETSIDE

Year

New

#### Chev

23-0SCHEV-T	stepside/Chevrolet-Taiwan made	54-87	\$429.95
23-0SCHEV	stepside /Chevrolet US made	54-87	\$604.95
21-0566-C	fleetside / Chev	58-66	\$899.95

#### GMC

23-0SGMC	stepside	54-87	\$499.95
23-0SGMC-A	stepside with original GMC script	55-62	\$639.95
21-0566-G	fleetside w / GMC	58-66	\$899.95

#### BLANK

23-0SBLANK	stepside	54-87	\$249.95
21-0566-B	fleetside w/ out letters	58-66	\$649.95

#### Louvered w/ 4 rows 4" wide

29-0679	stepside-US made	54-87	Inquire
---------	------------------	-------	---------

#### Tailgate Covers

complete cover that can be welded over tailgate

#### Blank

23-0758	stepside-US made	54-87	\$158.95
---------	------------------	-------	----------

#### Bowtie Embossed

23-0682	stepside	54-87	\$241.95
---------	----------	-------	----------

Due to the fluctuation of the Canadian and American dollars call for current prices

*Bill's Truck Shop*

Phone (905) 725-3460 / (905) 725-2022 / Fax (905) 404-2302 email: bill@billstruckshop.com



# Tailgates Parts

Due to the fluctuation of the Canadian and American dollars call for current prices

# Group 29



### Tailgate Chain Arm Pivot Bolt w/Lock Nut-used to adjust arm tension

		Year	New	Used
21-0308-Z	zinc-each	58-66	\$17.95	
21-0308-S	stainless steel-each	58-66	\$24.95	

### Tailgate -support/pivot bolt in bed side **NEW**

21-0308-BS	fits L & R	each	58-66	\$22.95
------------	------------	------	-------	---------

### Tailgate Chain Eye Brackets

22-0308-BL	in gate end	fleetside	left	58-66	\$19.95
22-0308-BR	in gate end	fleetside	right	58-66	\$19.95

### Tailgate to Bedside Striker/Guide

22-0308-GS	each w/ bolt	58-66	Inquire	
------------	--------------	-------	---------	--

### Tailgate Trunions / Hinge

22-0547-S	cadmium plated w/ bolts /stepside	pair	54-87	\$2495	
23-0381	urethane w/ ss bolts / stepside	pair	54-87	\$52.95	
22-0566	fleetside /cadmium plated	pair	58-66	\$38.95	\$15.00
21-0510-HK	Bolt kit-fleet side tailgate hinge-4pcs		58-72	\$14.95	

### Tailgate Chains w/ chain, hooks & eye bolt (pair)

21-0401-S	stainless steel - fleetside		58-66	\$99.95	
22-0FZ	zinc / fleetside		58-66	\$44.95	\$20.00
23-0SS	stainless steel /stepside		54-87	\$94.95	
23-0SZ	zinc / stepside		54-87	\$48.95	

### Tailgate Chain Covers (pair)

22-0CCB	black/ stepside		47-87	\$11.95
22-0CCC	clear / stepside		47-87	\$11.95
22-0CFB	black/fleetside w/ arm pads		58-66	\$16.95
22-0CFG	grey/ fleetside w/arm pads NLA		58-66	

### Bed Pad Set - rubber pads

31-0201-P	10 pcs	54-72	\$14.95	
-----------	--------	-------	---------	--

*Bill's Truck Shop*

Phone (905) 725-3460 / (905) 725-2022 / Fax (905) 404-2302 email: bill@billstruckshop.com

**CHEVROLET**

**CHEVROLET**

STEPSIDE

**GMC**

**GMC**

23-OGSB-55

**CHEV ROLET CHEV ROLET**

31-0649

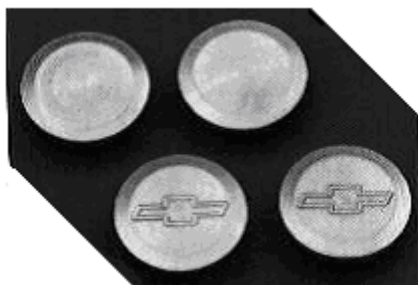

31-0752

31-0864



### Tailgate Letters

#### Stepside- Chev

23-0CSB	black / stepside	54-87	\$9.95
23-0CSW	white / stepside	54-87	\$9.95
23-0CSS	brushed stainless steel / stepside	54-87	\$9.95

#### Stepside- GMC

23-0GSB-55	black w/ OE style script	55-62	\$9.95
23-0GSW-55	white w/ OE style script	55-62	\$9.95
23-0GSS-55	brushed stainless w/OE style script	55-62	\$9.95
23-0GSB	black / stepside	54-87	\$9.95
23-0GSW	white / stepside	54-87	\$9.95
23-0GSS	brushed stainless steel/ stepside	54-87	\$9.95

#### Fleetside- Chev

21-0CFB	black / fleetside	58-66	\$9.95
21-0CFW	white / fleetside	58-66	\$9.95
21-0CFSS	brushed stainless steel/ fleetside	58-66	\$9.95

#### Fleetside- GMC

<b>21-0GFB</b>	<b>black / fleetside</b>	58-66	\$9.95
21-0GFW	white / fleetside	58-66	\$9.95
21-0GFSS	brushed stainless steel/ fleetside	58-66	\$9.95

**Bed Hole Plugs** Aluminium plug fits in hole at front and rear of *step side* bed rails. With rubber O-ring -- press in

#### Blank aluminium polished

31-0649	aluminum-polished-smooth	pair	47-66	\$89.95
31-0649-B	aluminum-brushed	pair	47-66	\$59.95

Bed Roll Light kit-fit 40-66 bed rolls and 40-87 Mar-k made bed side roll

31-0864	dual intensity LED lights w/ hdw & instructions			\$229.95
---------	---	--	--	----------

*Bill's Truck Shop*

Phone (905) 725-3460 / (905) 725-2022 / Fax (905) 404-2302 email: bill@billstruckshop.com

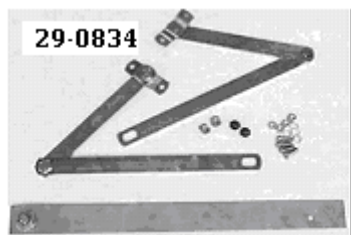

### STEPSIDE TAILGATE EDGE PROTECTOR

Screw & or urethane to gate

22-0STP	brushed stainless steel	54-87	\$79.95
22-0STP-B	satin black stainless steel	54-87	\$79.95

### Step side Stealth Tailgate Latches (pair)

Slotted stainless barrel w/spring loaded lock pin that is installed into the top gate roll & inserts in gate post

22-0SLK-S	stainless steel	pair	41-87	\$199.95
22-0SLK-Z	zinc coated	pair	41-87	\$94.95
21-0266	fleetside-Zinc	pair	58-66	\$159.95
21-0266-S	fleetside-stainless steel	pair	58-66	\$199.95

### Tailgate Arm Link kit- w/ instructions

Stepside

29-0834	arms w/ hdw for removal of chains-stepside	54-87	\$169.95
29-0834-S	arms w/ hdw for removal of chains stainless steel	54-87	\$239.95

Fleetside

21-0837	arms w/ hdw for removal of chains- fleetside	58-66	\$169.95
21-0837-S	arms w/ hdw for removal of chains- fleetside stainless steel	58-66	\$239.95

# Bed Parts

Due to the fluctuation of the Canadian and American dollars call for current prices

# Group 30

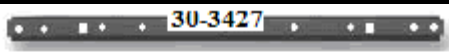

30-3427

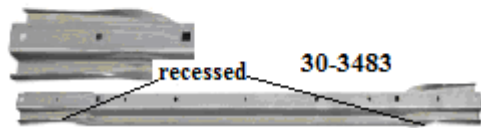

recessed 30-3483



30-3715-T

21-0722-HK



30-0826-T



30-0204-T



31-0202-SS

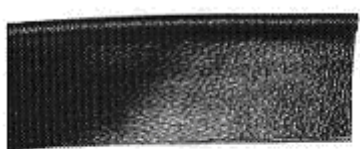

31-0WFB

			<u>Year</u>	<u>New</u>	<u>Used</u>
<b>Bed Cross Sill</b>	pre-drilled w/ support plates				
30-3427	galvanized stepside		55-59	\$79.95	
30-3483	#3-recessed @ rear shackle /short stepside		55-59	\$79.95	
<i>ends are stamped w/ recess for spring shackle</i>					
30-3433	Cross sill -each fleetside		58-59	\$62.95	
<b>Short fleet has 3 cross sills &amp; 1x 50 "rein</b>					
<b>/ long fleet has 5 cross sills&amp; 2 x 50 " reinforcement</b>					
<b>Reinforcement Strip</b>	predrilled				
30-0437	50 "- 58/59 fleetside between wheel tubs and 54/59 long step		54-59	\$44.95	
23-0706	w/ out holes stepside		54-87	\$25.00	
<b>Rear Cross Sill</b>	predrilled w/ support brackets				
30-3715-T	stepside		55-59	\$199.95	
30-3720	fleetside		58-59	\$299.95	
21-0722-HK	Rear cross sill hdw kit		54-87	\$13.95	

### ROLL PANS

**Rear Roll Pan** (steel) weld or bolts to rear cross sill  
And bed sides with **NO** tag lights holes

#### With License Box

30-0826-T	smooth w/licence box/made in Taiwan	54-87	\$224.95
30-0852	4 row louvered w /plate box stepside	54-87	Inquire
30-3118	smooth w/plate box fleetside	58-59	Inquire
30-3119	4 row louvered w / plate box fleetside	58-59	Inquire
24-0483	smooth - <b>long stepside</b>	54-87	\$279.95

#### Without License Box

24-0817	smooth / stepside	54-87	\$157.70
24-0839	smooth 4 row louvered / stepside	54-87	\$239.95
24-3819	smooth / fleetside	58-59	Inquire
30-3853	smooth 4 row louvered / fleetside	58-59	Inquire

#### Rear Roll Pan Tag Light

30-0204-T	top mount w/ chrome bezel		\$6.50
-----------	---------------------------	--	--------

#### Rear Step Fender Bolt Kit w/ bolts, washers& nuts

31-0202-SS	stainless steel with clutch type head	47-66	\$62.95
31-0202-SS-P	stainless steel w/philips head screw	47-66	\$69.95
25-06025	zinc w/ Phillips head	47-72	\$19.95

#### Rear Step Fender Welt Beading

31-0FWB	black vinyl 25'	47-72	\$21.95
---------	-----------------	-------	---------

## Bill's Truck Shop

Phone (905) 725-3460 / (905) 725-2022 / Fax (905) 404-2302 email: bill@billstruckshop.com

# Box Parts

Due to the fluctuation of the Canadian and American dollars call for current prices

# Group 31



31-0649

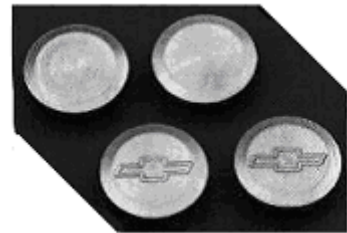

31-0752

31-0405

23-0414



23-0191



22-0LFP

Bed sides are made from 16 gauge electro-galvanized steel and come with angels installed, stake pockets, fender holes, USA are not primed. Bed sides can be ordered with many different options: e.g., no pocket holes SS angels, no fender holes. . Inquire if necessary .Items w/ T are off shore produced parts

			<u>Year</u>	<u>New</u>	<u>Used</u>
31-3639	short stepside	left	55-59	\$899.95	
31-3639-T	short stepside-made in Taiwan	left	55-59	\$699.95	
31-3640	short stepside	right	55-59	\$899.95	
31-3640-T	short stepside-made in Taiwan	right	55-59	\$699.95	
31-3639-SA	short step w/ PST angle installed	left	55-59	Inquire	
31-3640-SA	short step w/ PST angle installed	right	55-59	Inquire	
31-3545	long stepside 89"	left	55-57	Inquire	
31-3544	long stepside 89"	right	55-57	Inquire	
31-3546	long stepside 97"	left	57-59	Inquire	
31-3547	long stepside 97"	right	57-59	Inquire	
31-3397	cameo / suburban	left	55-58	Inquire	
31-3384	cameo / suburban	right	55-58	Inquire	

**Stake Pocket** - vertical post at front & rear of bed

31-0408	front	left	54-72	\$99.95	
31-0405	front	right	54-72	\$99.95	
23-0414	rear	left	54-66	\$139.95	
23-0411	rear	right	54-66	\$139.95	

**Stake Pocket Covers** – steel w/ side clips-paint to match

23-0191	steel/pair		54-87	\$36.95	
23-0192	steel/pair – fleetside		58-87	\$36.95	

**Bed Hole Plugs** Aluminium plug fits in hole at front and rear of stepside bed rails. With rubber O-ring -- press in. w/ instructions

**Bowtie** for Mar-k bed sides

31-0752	polished w/ bowtie	pair	47-66	\$89.95	
---------	--------------------	------	-------	---------	--

**Blank** for Mar-k bed sides

31-0649	polished /blank	pair	47-66	\$69.95	
---------	-----------------	------	-------	---------	--

22-0FLP

Flip down rear plate bkt

\$39.95

Due to the fluctuation of the Canadian and American dollars call for current prices

**Bill's Truck Shop**

Phone (905) 725-3460 / (905) 725-2022 / Fax (905) 404-2302 email: bill@billstruckshop.com



# Runningboards

Due to the fluctuation of the Canadian and American dollars call for current prices

# Group 32

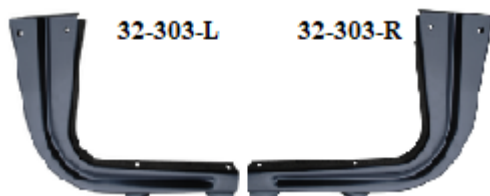
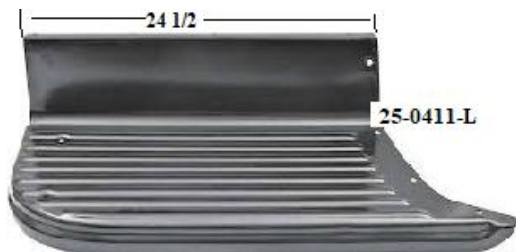

## Running Board

			<u>Year</u>	<u>New</u>
25-0410-L	short step /	left	55-66	\$235.95
25-0410-R	short step /	right	55-66	\$235.95
25-0410-LC	short step CHROME-	left	55-66	\$399.95
25-0410-RC	short step CHROME-	right	55-66	\$399.95
25-0411-L-	long step/step vertical is 24 1/2 long	left	55-66	\$224.95
25-0411-R -	long step/step vertical is 24 1/2 long	right	55-66	\$224.95
25-0412-L -	long step/step vertical is 28 1/2 long	left	55-66	
25-0412-R -	long step/step vertical is 28 1/2 long	right	55-66	

## Running board Support

32-303-L	left	55-59	\$46.95
32-303-R	right	55-59	\$46.95

## Running board Step Plates pair w/ hardware

Polished aluminium-diamond top w/blue Bowtie			
32-004	5 1/4 x 14	pair	47-72 \$99.95
32-005	non pol alum w /older GMC design 5x10 5/8-pr		47-72 \$89.95

## Running board Bolt Kit

25-0510-BK	-at support, sides & fender-Zinc	55-72	\$18.95
25-0510-BKS	chrome bolts w/ hdw-4 bolts	55-72	\$32.95

Due to the fluctuation of the Canadian and American dollars call for current prices

*Bill's Truck Shop*

Phone (905) 725-3460 / (905) 725-2022 / Fax (905) 404-2302 email: bill@billstruckshop.com

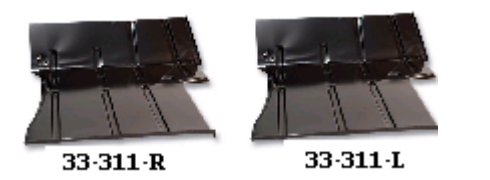
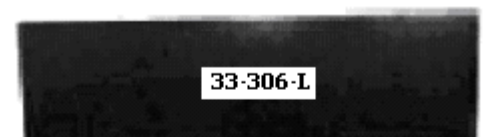
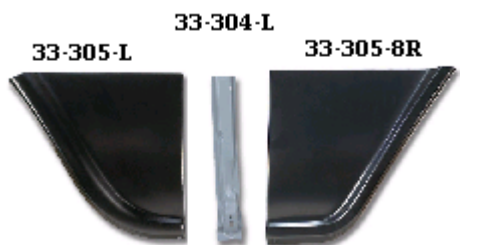

### Front Fender Brace

33-304-L	16" high	left	55-59	\$64.95
33-304-R	16" high	right	55-59	\$64.95

### Front Fender Lower rear

33-305-L	16" high	left	55-57	\$89.95
33-305-R	16" high	right	55-57	\$89.95
33-305-8L	16" high	left	58-59	\$74.95
33-305-8R	16" high	right	58-59	\$74.95

### Door Outer Skin

33-306-L	8" high	left	55-59	\$99.95
33-306-R	8" high	right	55-59	\$99.95

### Door Inner w/ Bottom

33-307-L1	9" high	left	55-59	\$139.95
33-307-R1	9" high	right	55-59	\$139.95

### Door Post w/ Hinge Pocket "A" pillar

33-308-LF	15" high	left	55-59	\$82.95
33-308-RF	15" high	right	55-59	\$82.95

### Door Pillar-Rear "B" Lower @ rocker step

33-308-LR	11 3/16 H	left	55-59	\$69.95
33-308-RR	11 3/16 H	right	55-59	\$69.95

### Rocker/ Step w/support brace

33-309-L		left	55-59	\$149.95
33-309-R		right	55-59	\$149.95
2 <sup>nd</sup> design w/ more defined step lines ( like OE) ,rocker support bkt , step support and recessed lip at top to join floor				
33-309-L-A			55-59	\$149.95
33-309-R-A			55-59	\$149.95

### Rocker/ Step Support Brace

32-0203-S	30" brace that is welded to bottom on cab step-each		55-59	\$24.95
-----------	---	--	-------	---------

### Rocker Step Plate Support

33-309-S	left or right	each	55-59	\$38.95
----------	---------------	------	-------	---------

### Rocker Panel Edge

33-310-L		left	55-59	\$74.95
33-310-R		right	55-59	\$74.95

### Cab Floor Pans w/toe board

33-311-L	28" L X 24" wide	left	55-59	\$139.95
33-311-R	28" L X 24" wide	right	55-59	\$139.95

*Bill's Truck Shop*

Phone (905) 725-3460 / (905) 725-2022 / Fax (905) 404-2302 email: bill@billstruckshop.com

# Sheet Metal/Repair Panels

# Group 33



33-313



33-314-L



33-212

33-316-R

33-315-R

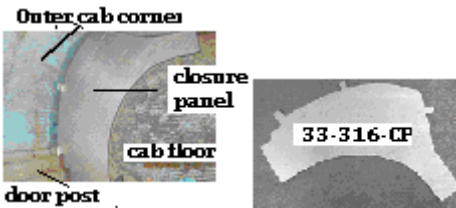
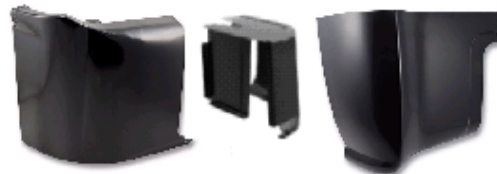

33-317-R



33-317-SK

33-321-L

33-322-I



33-324-L



33-325-L

## Rear Cab Support

33-313

Year

New

Used

55-59

Inquire

## Front Cab Support

33-314-L

left

55-59

\$74.95

33-314-R

right

55-59

\$74.95

## Rock Deflectors @ rear cab corner on stepside trucks

33-312

pair

55-59

\$22.95

## Cab Corner-outer w /door opening

33-315-L

15' high

left

55-59

\$84.95

33-315-R

15"high

right

55-59

\$84.95

## Cab Corner- inner

33-316-L

left

55-59

\$99.95

33-316-R

55-59

\$99.95

## Cab Corner Closure Panel *NEW ITEM*

33-316-CP

fits left or right side inner floor @ cab corner- comes w/ bend tabs for easy welding to cab-can also be used when NOT installing inner cab corners

each

55-59

\$12.95

## Inner Kick Panel Cover

with screws

33-317-L

left

55-59

\$69.95

33-317-R

right

55-59

\$69.95

33-317-SK

screw kit

12 pcs

55-59

\$2.50

## Outer Pillar Pocket

33-321-L

left

55-59

\$92.95

33-321-R

right

55-59

\$92.95

## Inner Pillar Pocket

33-322-L

left

55-59

\$89.95

33-322-R

right

55-59

\$89.95

## Fender Support Bracket @ lower hinge post

33-324-L

left

55-59

\$34.95

33-324-R

right

55-59

\$34.95

## Lower Door Hinge Bracket in door w/ fine thread nuts SEE group 12 page 30

33-325-L

left

55-59

\$59.95

33-325-R

right

55-59

\$59.95

*Bill's Truck Shop*

Phone (905) 725-3460 / (905) 725-2022 / Fax (905) 404-2302 email: bill@billstruckshop.com

# Sheet Metal

Due to the fluctuation of the Canadian and American dollars call for current prices

# Group 34



### Doors

		Year	New	Used
34-3LD	left	55-59	\$719.95	Inquire
34-3RD	right	55-59	\$719.95	Inquire

### Door Hinge Bolts

New Doors require 3/8 coarse thread bolts on door hinge pockets to secure hinge set of 6 per doors---2 x3/8 -16 x1 1/2 w/ 1 1/8 floating washer & 4 x 3/8-16 x 1 w/ 1" floating washer

34-3HB-K		55-59	\$10.00	
----------	--	-------	---------	--

### Fenders – Outer

34-355-FL	left	55-56	\$789.95	Inquire
34-355-FR	right	55-56	\$789.95	Inquire
34-357-FL	left	57-57	\$789.95	Inquire
34-357-FR	right	57-57	\$789.95	Inquire
34-358-FL	left	58-59	\$789.95	Inquire
34-358-FR	right	58-59	\$789.95	Inquire

### Front Sheet Metal hdw kit

34-355-HK	stainless flat washers & bolts-philips drive to secure fit fenders & hood latch panel	24 bolts w/ washers	55-59	\$39.95
-----------	---	---------------------	-------	---------

### Front Fender Braces -front

3-31FSS	polished stainless steel	pair	55-59	\$84.95
3-31F	steel	pair	55-59	\$42.95

### Fender Extension at fender & rad support

34-355-LE	left	55-57	\$99.95
34-355-RE	right	55-57	\$99.95
34-358-LE	left	58-59	
34-358-RE	right	58-59	

### Fenders - Inner

34-355-IL	uses 56-57 light harn grommet - left	55-57	\$269.95	Inquire
34-355-IR	uses 56-57 light harn grommet - right	55-57	\$269.95	Inquire
34-358-IL	left	58-59	\$249.95	Inquire
34-358-IR	right	58-59	\$249.95	Inquire

### Inner Fender Support @ firewall

34-355-S	left or right	each	55-59	\$10.95
34-355-S-SS	pair/brushed stainless w/ hdw		55-59	\$29.95

### Rad Support

34-355-RS	has 4 louvers per side	55-57	\$324.95	\$150.00
34-358-RS	has 3 louvers per side	58-59	\$259.95	\$100.00

### Park lamp Harness Grommet

16-305-G	each side of rad support	pair	55-59	\$5.75
----------	--------------------------	------	-------	--------

### Grille Surround

34-358-GS		58-59	\$449.95	Inquire
-----------	--	-------	----------	---------

*Bill's Truck Shop*

Phone (905) 725-3460 / (905) 725-2022 / Fax (905) 404-2302 email: bill@billstruckshop.com

# Sheet Metal

Due to the fluctuation of the Canadian and American dollars call for current prices

# Group 34

			<u>Year</u>	<u>New</u>	<u>Used</u>
	<b>Hoods</b>				
34-355-HC	34-355-HC smooth	Chev	55-56	\$899.95	Inquire
	34-357-HC w/ spears	Chev	57-57	\$999.95	Inquire
34-357-HC	34-355-HG smooth	GMC	55-56		Inquire
	34-357-HG	GMC	57-57		Inquire
	34-358-H	GMC & Chev	58-59	\$1299.95	Inquire
	<b>Hood Latch Panel</b>				
34-312-55C	34-312-55C	Chev	55-57	\$109.95	\$50.00
	34-312-55G	GMC	55-57		\$100.00
	34-312-58C	Chev	58-59	\$109.95	\$50.00
	34-312-58G	GMC	58-59		\$100.00
	<b>V-8-Filler Panel-rad support to latch panel</b>				
34-313-C	Chev w/ factory v8 engine		55-59		\$40.00
	<b>Stepside Rear Fenders</b>				
25-0566-R	25-0566-R right		55-66	\$799.95	Inquire
	25-0566-L w/ out spare cut-out	left	55-66	\$799.95	Inquire
	25-0566-LS w/ spare tire cut-out for LONG STEP	left	55-66	\$799.95	Inquire
	<b>Fender Braces-stepsides</b>				
25-359-F	25-359-F steel @ front step w/treaded end	each	55-59	\$34.95	
	25-0566-K 3 pc set per fender		55-66	\$26.95	
	25-0566-SSK fender brace kit stainless steel 6 pc set w/ hdw		55-66	NLA	
	<b>Transmission Floor Cover – see section 8</b>				
33-345	33-345 OE style		55-59	\$119.95	\$50.00
	<b>Cowl Screen</b>				
33-345-A	33-345-A custom style w/ o grill		55-59	\$109.95	
	33-345-C OE style- chrome		55-59	\$192.95	

## Bill's Truck Shop

Phone (905) 725-3460 / (905) 725-2022 / Fax (905) 404-2302 email: bill@billstruckshop.com



# Sheet Metal

Due to the fluctuation of the Canadian and American dollars call for current prices

# Group 34

		<u>Year</u>	<u>New</u>	<u>Used</u>
	<b>Inner Firewall Cowl Panel</b>			
34-360-I	34-360-I	55-59	\$449.95	
	<b>Outer Firewall Cowl Panel</b>			
34-360-O	34-360-O	55-59	\$445.95	
	<b>Firewall Panel</b>			
34-361	34-361 complete replacement panel w/ factory holes- Chev Has 55-57 batter tary hole pattern	55-59	\$532.95	
	<b>Cab Rear Panel Outer w/ small back window</b>			
34-359-OB	34-359-OS	55-59	\$1199.95	
	<b>Cab Rear Panel Outer w/ big back window</b>			
34-359-OS	34-359-OB	55-59	\$999.95	
	<b>Cab Rear Panel Inner w/ big back window</b>			
34-359-IB-B	34-359-IB	55-59	\$410.00	
	<b>Cab Rear Panel Inner w/ small back window</b>			
34-359-IB	34-359-IS	55-59	\$249.95	
	<b>Cab Rear Panel Inner w/ B-pillar @ big back window</b>			
	34-359-IB-B	55-59	\$899.95	

Due to the fluctuation of the Canadian and American dollars call for current prices

## Bill's Truck Shop

Phone (905) 725-3460 / (905) 725-2022 / Fax (905) 404-2302 email: bill@billstruckshop.com

# Sheet Metal

Due to the fluctuation of the Canadian and American dollars call for current prices

# Group 34

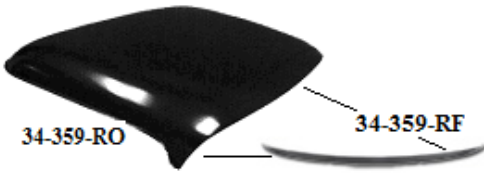

**Roof-Outer Skin**-includes roof to windshield opening panel

34-359-RO

Year      New      Used

55-59      \$729.95

**Roof-Inner skin** – includes side drip rails and ft inner w/ braces

34-359-RI a complete replacement panel-excellent for roof rot repair around front window

55-59      \$695.95

**Roof-front/inner**

34-359-FI replacement for front inner only-wraps around front 6 “ of roof –joins to 34-359-RF

55-59      \$179.95

**Roof to window filler replacement panel**

34-359-RF window pinch weld to outer roof skin

55-59      \$109.95

**Support Brace- cab floor to rear wall inner support above @ cab support ( do not come w/new floor)**

33-330-BL w/weld in holes-drivers side each 55-59      \$29.95

33-330-BR w/weld in holes pass side each 55-59      \$29.95

33-330-BK pair 55-59      \$79.95

**Cab Floor** –up to front seam--does not include ft cab supports

33-314 L & R & rear cab braces 33-330-BK

33-330 complete floor w/ steps 55-59      \$1295.95

*Bill's Truck Shop*

Phone (905) 725-3460 / (905) 725-2022 / Fax (905) 404-2302 email: bill@billstruckshop.com

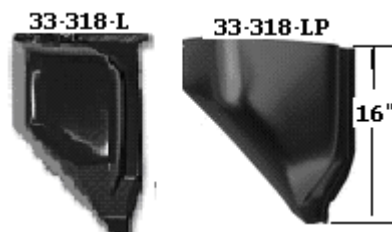

**Cab "A" Pillar assembly w/ in & outer air box**

		<u>Year</u>	<u>New</u>
34-3360-L	left front pillar	55-59	\$609.95
34-3360-R	right front pillar	55-59	\$609.95

**Cab "A" Pillar-full replacement-outer**

34-3361-L	left	55-59	\$224.95
34-3361-R	right	55-59	\$224.95

**Cab Kick panel w/ air valve**

34-3362-L	left	55-59	\$271.95
34-3362-R	right	55-59	\$271.95

**Cab "B" Pillar-full replacement**

34-3364-L		55-59	\$249.95
34-3364-R		55-59	\$249.95

**Cage Nut—weld in support w/ nut & weld in holes - replaces the missing, rusty or stripped nut & support**

34-3363-CN	includes 1 fender bolt 1x 1/16 & 1/8 shim fits left & right	BTS exclusive	each	55-59	\$29.95
------------	---	---------------	------	-------	---------

**Outer Cowl Air Box-full replacement part**

33-318-L	left	55-59	\$104.95
33-318-R	right	55-59	\$104.95

**Outer Cowl Air Box-partial repair item**

33-318-LP	left	55-59	\$99.95
33-318-RP	right	55-59	\$99.95

*Bill's Truck Shop*

Phone (905) 725-3460 / (905) 725-2022 / Fax (905) 404-2302 email: [bill@billstruckshop.com](mailto:bill@billstruckshop.com)

# Sheet Metal

Due to the fluctuation of the Canadian and American dollars call for current prices

# Group 34



### Cabs- w/ Chev dash—GMC dash can be installed

		<u>Year</u>	<u>New</u>	<u>Used</u>
34-355-CS	Chev w/ small back window	55-59	Inquire	Inquire
34-355-CB	Chev w/ big back window	55-59	Inquire	Inquire

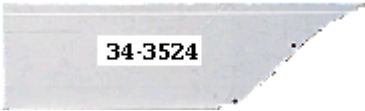

### Fleetside Bed Repair Panels

Repair panels for front & rear of wheeltubs-16 gauge electro-galvanized-predrilled holes @ floor and wheel tub

34-3521	front inner left-short fleetside	58-59	\$69.95	
34-3522	front inner right-short fleetside	58-59	\$69.95	
34-3523	rear inner left-short fleetside	58-59	\$69.95	
34-3524	rear inner right-short fleetside	58-59	\$69.95	

### Rear Barn Doors-panel/suburban

34-370-L	left	55-59		Inquire
34-370-R	right	55-59		Inquire

### Rear Clam Shell

34-371-U	upper	55-59		Inquire
34-371-L	lower	55-59		Inquire

## Bill's Truck Shop

Phone (905) 725-3460 / (905) 725-2022 / Fax (905) 404-2302 email: bill@billstruckshop.com

# Dash

Due to the fluctuation of the Canadian and American dollars call for current prices

# Group 33



### Dash Panel

33-340-C	Chev	55-59	\$669.95	Inquire
33-340-G	GMC	55-59		Inquire

### Radio- Dash Repair Panel

33-357	w/ all factory holes	Chev only	55-59	\$57.95
33-357-S	smooth replacement panel	10 3/4W x 8 1/2 H		
Chev only			55-59	\$39.95

*Bill's Truck Shop*

Phone (905) 725-3460 / (905) 725-2022 / Fax (905) 404-2302 email: [bill@billstruckshop.com](mailto:bill@billstruckshop.com)



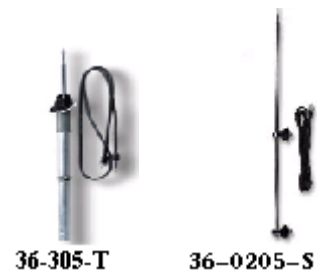

36-305-T      36-0205-S

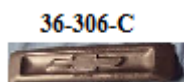

36-306-C



36-309-S      36-309



36-307-C

36-309-C



36-0307-54G



36-304-DVC

36-312-S



36-312-B



36-312-SK

**Original Antenna** With cable and hardware,  
36-305-T telescopic w/ hardware 55-59 \$139.95

**If installing a new ant in the existing hole make sure it is in the correct location as it will only fit in the OE location -fender edge at rear**

**Side Mount Antenna**-universal w/ cable and hardware -stainless steel  
36-0205-S dual stand side mount 36-59 \$49.95  
36-0205-S1 single stand side mount 36-59 \$39.95

**Radio Delete Plate**

36-330-C OE plate w/ Chev logo and control button plugs 55-59 \$75.00  
36-330-G OE plate w/ GMC logo and control button plugs 55-59 \$75.00

**Radio Face Plate Tuning Indicator**

36-307-C Chev 55-59 \$15.95  
36-0207-54G white screened GMC 54-59 \$19.95

**Original Radio**-rebuilt w/ one year warranty

36-309-G GMC 12 volt 55-59 \$495.00  
36-309-C Chev 12 volt 55-59 \$450.00

**Radio Knob** chrome

36-309 3/16 hole with lock screw 55-59 \$18.95

**Radio Spinner Knobs**

36-309-S plastic/chrome pair 55-59 \$14.95

**Original Speaker**

36-312-S 55-59 \$49.95

**Dual Voice Cone Speaker**-fits original housing

36-304-DVC 140 watts 55-59 \$89.95

**Speaker Cover**

36-312-C chrome 55-59 \$89.95  
36-312-B black 55-59 NLA

**Speaker Cover Screw kit 4 pcs**

36-312-SK 4 x 2 1/2 screws 55-59 \$2.50



**36-320-KP**



**5-0HAN**



**36-3USA-2**



**5-00RC**

**Kick panel Speaker set**-Plastic panels w/moulded speaker (4 " 2 way 60 watt speakers)-pair

36-320-KP 55-59 \$209.95

36-320 w/o speaker/install you own 55-59 \$139.95

**Radio-AM/FM – 55-59 CHEV Radio-AM/FM – new 12V** ,electronic shafts, aux inputs for iPod,MP3,DVD,Satellite, seek & scan, digital clock,200 watts w/ chrome bezel & CHEV logo-fits original location w/o any modification-

36-3USA-2 55-59 \$299.95

Amplified Electronic AM/FM Hidden Antenna—requires 12 volt-includes 80” cable- peel- stick application

5-0HAN universal \$49.95

**Radio-AM/FM – new 12V** ,electronic shafts, aux inputs for iPod,MP3,DVD,Satellite, seek & scan, digital clock,200 watts w/ chrome bezel & CHEV logo-fits original location w/o any modification-**Chev USA 740 W/ BLUETOOTH**

36-3USA-7 55-59 \$499.95

**Inquire about 55-59 GMC truck radios**

Amplified Electronic AM/FM Hidden Antenna—requires 12 volt-includes 80” cable- peel- stick application

5-0HAN universal \$39.95

**Condenser---Radio(noise) Suppression Condenser**

5-00RC when using point ignition \$19.95

*Bill's Truck Shop*

Phone (905) 725-3460 / (905) 725-2022 / Fax (905) 404-2302 email: bill@billstruckshop.com

# Brakes

Due to the fluctuation of the Canadian and American dollars call for current prices

# Group 37



				<u>Year</u>	<u>New</u>	<u>Used</u>
<i>all 1/2 ton application &amp; bonded unless noted</i>						
<b>Brake Shoes (per axle)</b>						
37-0202-F	1/2 ton front shoes 2" set of 4	51-62	\$49.95	51-62	\$74.95	
37-0202-F/P	premium brand-riveted lining set 2"	51-62		51-62	NLA	
37-0202-R	1/2 ton rear shoes 11x 1 3/4 set of 4	51-58		51-58	\$79.95	
37-0202-F	1/2 ton rear shoes 2" set of 4	51-62		51-62	\$74.95	
37-0330	53-59 front & rear-64-70 rear 3/4 ton Brake shoe set- 12 x 2	53-59		53-59	\$79.95	
<b>We provide brake shoe relining on all large size brake shoes - approx \$ per shoe \$69.00</b>						Inquire
37-0204	14 x 2 1/2 rear set of 4 1 ton	53-59		53-59	Inquire	
<b>Wheel Cylinder (each)</b>						
37-0203-FL	1.125 bore front L 1/2ton	51-59		51-59	\$39.95	
37-0204-FR	1.125 bore front R 1/2 ton	51-59		51-59	\$39.95	
37-0303-RL	31/3200--- rear left 1/2 ton and 57-59 31—4x4	55-72		55-72	\$29.95	
37-0303-RR	31/3200-----rear right 1/2 ton and 57-59 3100 4x4	55-72		55-72	\$29.95	
37-0209	3600---- 3/4 & 1 front or rear L or R 1 1/4 bore each	53-59		53-59	\$99.95	
37-0009	3/4 & 1 front L or R w/ 1 1/8 bore each	53-59		53-59		
37-0499	rear cylinder or rear w/ dual cylinder 1 1/2- 2 ton Chev & GMC fit L or R each	53-59		53-59	\$155.00	
37-0500	front cylinder or rear w/ dual cylinder 1 1/2- 2 ton Chev & GMC fit L and R each	53-59		53-59	\$155.00	
<b>Wheel Cylinder Cups</b>						
37-0124	1 1/8 cup size each				\$1.75	
37-0138	1 3/8 cup size---each				\$1.75	
37-0125	1 1/4 cup size each				\$3.95	
<b>Wheel Cylinder Rebuild kit</b>						
37-0054	1 1/4 " bore				\$24.95	
17-0036	1 1/8 " bore				\$20.95	
17-0046	1 " bore				\$11.50	
37-0038	1 3/8 bore				\$36.95	
37-0036	1 3/16 bore				29.95	
<b>Wheel Cylinder Push Rod</b>						
37-0050		each		51-72	\$6.95	
<b>Brake Shoe Guide Plate</b>						
37-0051	1/2 & 3/4 ton	each		51-87	\$9.95	
<b>Bleeder Screw</b>						
17-0402	3/8 head 3/8 x 24	each		47-7	\$1.69	

*Bill's Truck Shop*

Phone (905) 725-3460 / (905) 725-2022 / Fax (905) 404-2302 email: bill@billstruckshop.com

# Brakes

Due to the fluctuation of the Canadian and American dollars call for current prices

# Group 37

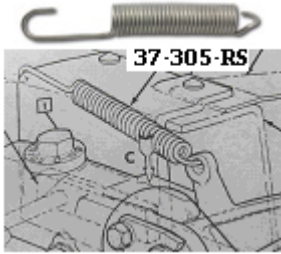

### Master Cylinder line adaptor

37-0829 5/16 inverted male w/ 1/4 female includes brass washer & 3/16 & 1/4 line fitting

\$7.95

### Washer-master cylinder adaptor

37-0245 .800 OD-.500 IN

\$2.25

### Brake Pedal Return Spring

37-305-RS

55-59

\$6.95

### Backing Plate Plugs

38-0250

each

\$0.85

### Hydraulic Brake Light Switch

45-0134 w/ adaptors & 3/16 line fittings & adaptors--closed circuit @ 45PSI

\$32.95

45-0134-S switch only

\$18.60

*Bill's Truck Shop*

Phone (905) 725-3460 / (905) 725-2022 / Fax (905) 404-2302 email: [bill@billstruckshop.com](mailto:bill@billstruckshop.com)

# Brakes

Due to the fluctuation of the Canadian and American dollars call for current prices

# Group 37

			<u>Year</u>	<u>New</u>	<u>Used</u>
	<b>Master Cylinder</b> complete new assembly				
37-305	1 1/8 cup      1/2 - 3/4 - 1 ton		55-59	\$189.95	
<b>Rebuild Kit Master Cylinder</b>					
	37-0146	1 1/8 bore	51-59	\$48.95	
	37-0033	1 1/4 bore -3/4 - 1 - 1 1/2 - 2 ton	36-59	\$49.95	
<b>Master Cylinder Fill Cap</b>					
	37-0211	1 1/4 OE metal w/gasket	40-59	\$34.95	
	37-0211-A	1 1/4-plastic w/ gasket	40-59	\$19.95	
<b>Master Cylinder Boot</b>					
	10-0504-MB	w/ manual brakes	47-72	\$6.00	
<b>Master Cylinder Bracket kit-</b>					
	37-3MCA	to convert to dual master w/ hdw	55-59	\$189.95	
For manual brakes only see page 92 for power brake kits					
<b>Master Cylinder-dual master for above kit-drum application only</b>					
	17-0505	NEW drum/drum master cylinder-1" bore		\$99.95	
<b>Master Cylinder w/ prop valve &amp; bracket-when installing updated master under cab w/booster</b>					
	37-0759	disc- drum prop valve w/ lines & bracket	47-59	\$235.95	
	37-0760	disc- disc prop valve w/ lines & bracket	47-59	\$235.95	
	45-0DBK-5				
<b>Bracket kit w/o master cylinder</b>					
	37-0759-B	includes disc-drum valve,lines,harness	47-59	\$144.95	
Prop valve rear fitting					
	17-0038	Fitting--9/16-18 inverted male to 3/8-24 female		\$6.95	
	17-0016	Fitting--9/16-18 inverted male to 7/16-24 female		\$6.95	
	17-0020	Fitting--9/16-18 inverted male to 1/2-20 female		\$6.95	
<b>Harness-proportioning valve switch</b>					
	17-0PVK-H	replacement harness w/ socket		\$19.95	

*Bill's Truck Shop*

Phone (905) 725-3460 / (905) 725-2022 / Fax (905) 404-2302 email: bill@billstruckshop.com



# Brakes

Due to the fluctuation of the Canadian and American dollars call for current prices

# Group 37

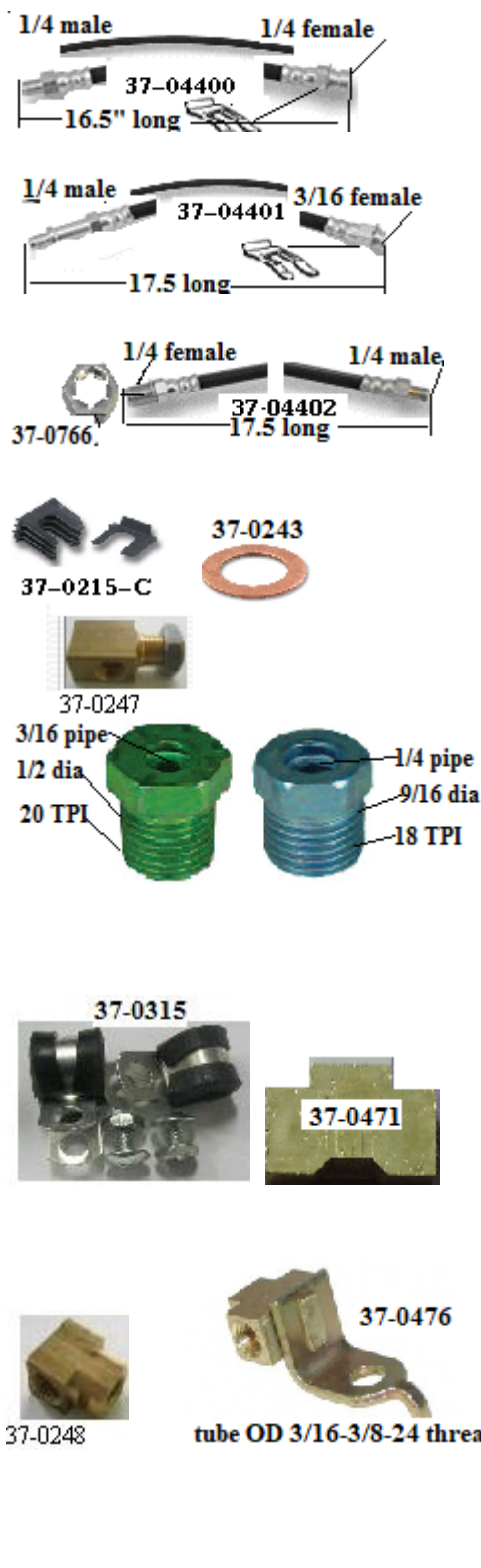

		<u>Year</u>	<u>New</u>	<u>Used</u>
<b>Brake Hose</b> (each) see hose info for correct application when ordering				
37-04400	1/4 line w/Posi traction 1/2 ton rear-each	58-59	\$24.95	
37-04400	1/4 line 3/4 ton rear-each	55-59	\$24.95	
37-04401	3/16 line- 1/2 ton 3100 front-each	57-59	\$36.95	
37-04401	3/16 line- 1/2 ton 3200 front-each	55-56	\$36.95	
37-04402	3/16 line- 1/2 ton longbed front-each	57-59	\$39.95	
37-04402	1/4 line 3/4 ton front-each	55-59	\$39.95	
37-04402	1/4 line 1/2 ton 3100 rear-each	55-59	\$39.95	
<b>Hose ID-</b> #04401 extended wheel cylinder end w/ "U" clip to secure on bkt ///04402 threaded end for nut (#37-0024) to secure through frame/// 04400 "U" clip to secure on support				
<b>Brake Hose Nut</b>				
37-0766	thread nut each		\$1.25	
<b>Brake Hose Gasket</b>				
37-0243	7/16 ID each		\$1.25	
37-0795	3/8 ID each		\$1.25	
<b>Brake Hose Clips</b> (each)				
37-0215-C			\$1.25	
<b>Brake Line Division Block</b>				
37-0247	brake line "T" on R frame rail-secured w/ nut	51-57	\$33.95	\$15.00
<b>Rear Axle Division block</b>				
37-00476	38-70 Rear flex hose splitter block-secures to diff housing bracket w/ clip - flex line 7/16-20 on one side and 3/8-24 on the other 2 sides	51-70	\$26.95	\$15.00
<b>Brake Fitting-oversize</b>				
37-03025	( blue ) 1/4 pipe-9/16 dia-18 threads per inch		\$3.50	
37-03026	( gold ) 1/4 pipe-1/2 dia-20 threads per inch		\$3.50	
37-03023	( green ) 3/16 pipe-1/2 dia-20 threads per inch		\$2.00	
37-03024	( olive ) 3/16 pipe 9/16-18 threads per inch		\$3.50	
37-0471	"T" fitting 3/8-24 3/16 lines each		\$6.99	
<b>Clamp-insulated</b>				
37-0315	3/8 w/ hdw pair		\$3.75	
<b>Rear Axle Division block</b>				
37-0248	secures to diff housing bracket w/ clip to split ( 3/16 ) brake lines 1/2 ton NOT 53 & 54	51-66	\$29.95	\$15.00
37-0249	Rear axle block fitting 1/4 line	36-65	\$34.95	
<b>Division Block w/ mount bracket ( universal )</b>				
37-0476	3/16 tube 3/8-24 thread		\$29.95	

## Bill's Truck Shop



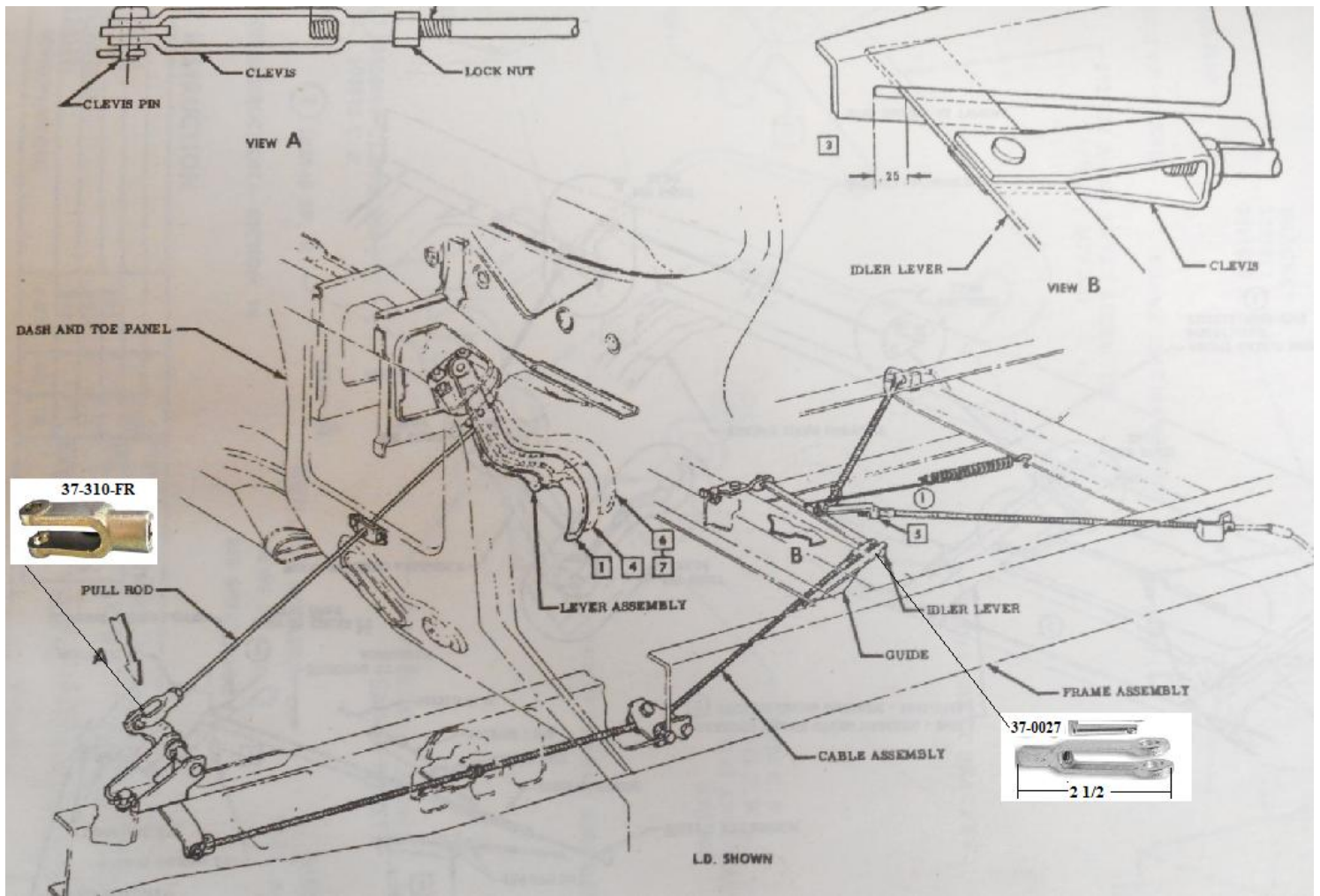





Phone (905) 725-3460 / (905) 725-2022 / Fax (905) 404-2302 email: bill@billstruckshop.com



# Brakes

Due to the fluctuation of the Canadian and American dollars call for current prices

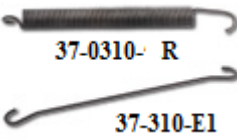
# Group 37

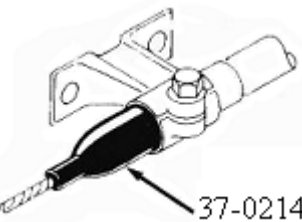
			<u>Year</u>	<u>New</u>	<u>Used</u>
<b>37-0200</b>	<b>37-0217</b>	<b>Brake Drum (each)</b>			
		37-0217 front or rear 1/2 ton 11" each	51-70	\$79.95	
<b>38-0206-FR</b>		37-0200 front brake drum 12 x 2 3/4 and 1 ton	53-62	\$169.95	
		<b>Brake Spring Kit</b> -hold down & return per axle			
<b>37-310-FR</b>		38-0206-FR front & rear axle 1/2 ton	51-63	\$18.95	
		<b>Brake Shoe Hold Down kit</b>			
	<b>38-0435</b>	38-0138 3/4 ton up -w/ 2 3/4 pin 12" shoes and up/ ft and rear per axle	51-87	\$12.95	
		<b>Brake Adjuster Screw</b> w/ out self adjusting brakes			
<b>38-0208</b>		38-0208 L or R front & rear each	51-62	\$16.95	
		<b>Parking Brake Cable</b>			
<b>38-0138</b>		37-310-FS front shortbed 3100	55-59	\$24.95	
		37-310-FL front longbed 3200	55-59	\$26.95	
<b>37-0310-R</b>		37-310-R rear cable 1/2 ton	55-59	\$44.95	
		37-310-R-B w/Dana rear end-bolts to backing plate Total length approx. 64 / casing length approx. 32	55-59	\$69.95	
<b>37-310-E1</b>		<b>Park Brake Return Spring</b>			
		37-0310-R spring w/ rod-locates @ center frame support-	55-65	\$11.95	
<b>37-310-E2</b>		<b>58-59 1/2 ton, 58-59 4x4</b>	55-59	\$4.75	
		37-310-E1 6 ft short bed extension	55-59	\$4.75	
<b>17-0102-C</b>		37-310-E2 8 ft extension	55-59		Inquire
		<b>Yoke-Parking Brake Rod Clevis</b>			
<b>37-0214</b>		37-0027 cable end at frame pivot 5/16 NF w/pin	55-59	\$9.95	
		37-310-FR @ rod end at frame pivot	55-59	\$14.95	
		----- @ at front of park rod & frame bkt			
		<b>Pin-cable yoke end</b>			
		38-0435 5/16 x 1 1/4	47-55	\$1.45	
		<b>Parking Brake Cable Reducer</b>			
		17-0500A adjustable to reduce length of cable- each		\$9.00	
		<b>Parking Brake Cable Boot</b>			
		37-0214 each	47-59	\$5.95	
		<b>Park Brake Cable Retainer</b>			
		17-0102-C OE wire style pair	55-87	\$5.95	

*Bill's Truck Shop*

Phone (905) 725-3460 / (905) 725-2022 / Fax (905) 404-2302 email: bill@billstruckshop.com

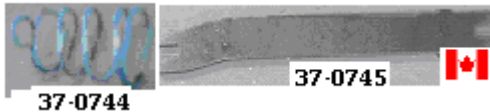

**Brake Spring Kit** -hold down & return per axle

38-0206-FR front & rear axle 1/2 ton 51-63 \$15.95



**Brake Shoe Hold Down kit**

38-0138 3/4 ton up -w/ 2 3/4 pin 12" shoes and up/ ft and rear per axle 51-87 \$12.95



**Brake Adjuster Screw** w/ out self adjusting brakes-has coarse tooth spacing

38-0208 L or R each 51-62 \$15.95 \$5.00



**Park Brake Bar**

37-0745 Strut-park brake 1/2-ton approx 7 1/2 long w/ 11 brakes 51-77 \$11.95

**Park Brake Bar Spring**

37-0744 @ cross bar & front shoe each 51-87 \$3.75



**Fits 64-75 1/2-3/4 ton rear 2 and 4 wheel drive, 64 1/2 ton 2 wheel drive front, and 65-75 1/2 ton 2 and 4 wheel drive front.-can use to upgrade to self adjusting brakes from 51-63**

17-0508 Brake Adjuster kit w/ 11 brakes L side 64-75 \$29.95

17-0509 Brake Adjuster kit w/ 11 brakes R side 64-75 \$29.95

17-0444 Park brake arm retainer clip w/ tension washer 2 pair /both sides 60-91 \$3.00

17-0444-S 2 Stud- park brake arm to shoe w/washer & clips \$9.95

17-0444-S **These park arms used the stud w/ C clip to secure to the shoe ( not the bolt w/nut )**

17-0701 Park brake cable arm-left 1/2 ton 64-91 \$34.95

17-0702 Park brake cable arm-right 1/2 ton 64-91 \$34.95

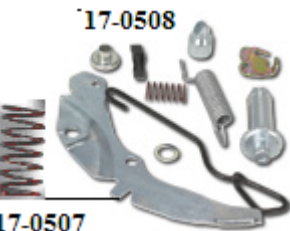

**SELF ADJUSTING BRAKES-self adjusting brakes can be applied to any 1951-66 chev 1/2 brakes-add 17-0508 (right) and 17-0509 (left) for front 7 rear**

**Adjuster arm Spring**

Sunvisor each \$1.50



# BRAKES



37-318-P



37-318-R



37-318-G

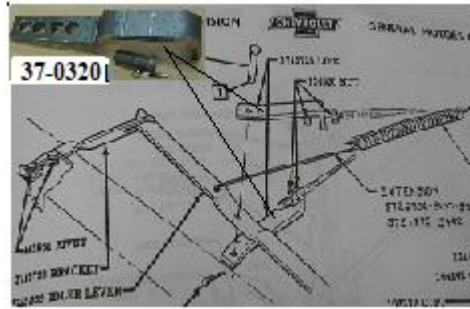

37-0320

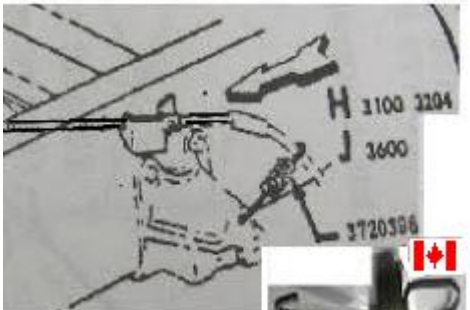

37-310-RS

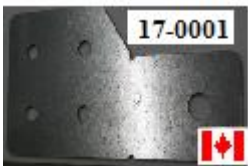

17-0001

## Parking Brake Roller

37-318-R nylon cable guide under cab 55-59 \$15.95

## Parking Brake Roller Pin

37-318-P special collar bolt 55-59 \$10.95

## Parking Brake Cable Hardware Pedal, linkage, etc.

### Parking Cable Roller & Bracket

37-318 @ frame for front cable 55-59 \$30.00

### Parking cable extension

37-0320 park cable at crossmember fits left & right w/ hdw each 55-59 \$22.95

## Parking Brake Cable Hardware Pedal, linkage, etc.

37-319 55-59 Inquire

## Grommet-front park cable @ transmission crossmember

37-318-G 55-59 \$2.00

## Spring-brake cable

37-310-RS located @ shackle to secure rear cables-each 55-59 \$8.95

## Universal Park Cable Support

17-0001 11 gauge galvanized steel-can be used to anchor park cables on frame-bend support to each application-9/16 cable hole-may require enlarging/includes hdw-bend bkt to fit application \$18.95

*Bill's Truck Shop*

Phone (905) 725-3460 / (905) 725-2022 / Fax (905) 404-2302 email: bill@billstruckshop.com



# Front Suspension Parts

# Group 38



38-0325-O

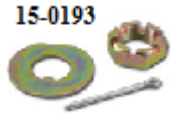

15-0193



38-0326



38-04759-BK

38-04759-S



38-0230-S



38-0230-N



17-0977



38-0250

### Backing Plates-brake shoe

			<u>Year</u>	<u>New</u>	<u>Used</u>
37-0325-F	front 1/2 ton	L or R	55-62		\$35.00
37-0325-R	rear 1/2 ton	L or R	55-62		\$50.00

### Wheel Bearings Hubs

38-320-H	1/2 or 3/4 ton		55-59		\$50.00
----------	----------------	--	-------	--	---------

### Wheel Bearing/Seal Shield

38-0324	between bearing & knuckle	each	55-59		\$5.00
---------	---------------------------	------	-------	--	--------

### Wheel Bearings-front

38-0325 -I	inner wheel bearing- ball type-1/2 ton		38-59	\$79.95	\$30.00
38-0325-O	outer wheel bearing-ball type-1/ 2 ton		38-61	\$59.95	\$20.00
38-0325-3I	inner wheel bearing- ball type-3/4 & 1 ton		53-59	\$69.95	\$20.00
38-0325-3O	outer wheel bearing-ball type 3/4 & 1 ton			\$88.50	\$20.00

### Dust Shield for inner seal & bearing

38-0303	tin shield & spindle backing plate	each	47-62		\$3.00
---------	------------------------------------	------	-------	--	--------

### Grease Seal-front

38-0326	1/ 2 ton 2 whl drive	each	38-59	\$24.95	
38-0669	3/4, 1 and 1-1/2 ton	each	35-59	\$25.95	

### 38-04759-BK

### Wheel Bearings kit-upgrades to tapered roller

bearings w/ grease seals	1/2 ton only		47-59	\$189.95	
--------------------------	--------------	--	-------	----------	--

### Wheel Stud

s (each)

38-0230-S	7/16-20 X 1 3/8	each	51-70	\$3.99	
-----------	-----------------	------	-------	--------	--

### Wheel Nut

38-0230-N		each	36-70	\$3.50	
-----------	--	------	-------	--------	--

### Spindle Nut and Washer

15-0193			47-87	\$14.95	
---------	--	--	-------	---------	--

### Spindle Dust Cap

17-0977	approx 2 3/32 " OD	each	47-62	\$9.95	
---------	--------------------	------	-------	--------	--

### Backing Plate Plugs







38-0250		each		\$0.85	
---------	--	------	--	--------	--

*Bill's Truck Shop*

Phone (905) 725-3460 / (905) 725-2022 / Fax (905) 404-2302 email: bill@billstruckshop.com

# Frame-Suspension Parts

# Group 38

				<u>Year</u>	<u>New</u>	<u>Used</u>
	<b>Spindle</b> checked for king pin size					
	38-330	left or right	1/2 ton each	55-59		\$100.00
	38-330-3/4	left or right	3/4 ton each	55-59		\$100.00
	<b>Front I Beam</b>					
	38-340		1/2 ton	55-59		\$250.00
	38-340-1		3/4 -- 1 ton	55-59		inquire
	<b>Bracket-2 &amp; 3 frame cross member support -each</b>					
	38-345-S	fits L & R w/ hdw	each	55-59		\$34.95
	. For rear leaf spring setups, these items help correct your rear end to <b>driveshaft angle</b> and eliminate vibration during operation at all speeds. Misalignment is common on lowered and lifted vehicles Our axle shims are also an important item when you have added power steering to your vintage straight axle front end. Original straight axle front ends came with minimal caster angle to make steering easier on the driver. When power steering is added, the <b>caster angle</b> must be increased or "road wander" becomes prevalent.					
	<b>Pinon &amp; Caster Angle Shim set</b>					
	39-0004-FR	2 " wide 4 deg w/ bolt-ft	caster or rear pinion angle	47-54		\$52.95
	39-3004	original caster shims 2" wide	pair	55-59		\$10.00
	<b>Leaf Spring</b>					
	39-310-F	1/2 ton	set of 7 pair	55-59	Inquire	\$150.00
	39-310-R	1/2 ton	set of 8 pair	55-59	Inquire	\$150.00
	<b>Main Leaf Spring</b> -replace the main leaf only if bushing eyelets are broken or worn OR if leaf is broken- bushing not included					
	39-310M-F	front	1/2 ton only each	55-59		\$139.95
	39-310M-R	rear	1/2 ton only each	55-59		\$139.95
	<b>Leaf Spring Center Bolt w/nut</b> ----- confirm size					
	39-0211-3/8	3/8 x 7 "	each	47-72		\$5.95
	39-0211-5/16	5/16 x 7 "	each	47-72		\$5.95

*Bill's Truck Shop*

Phone (905) 725-3460 / (905) 725-2022 / Fax (905) 404-2302 email: bill@billstruckshop.com

# Steering & Suspension

Due to the fluctuation of the Canadian and American dollars call for current prices

# Group 39

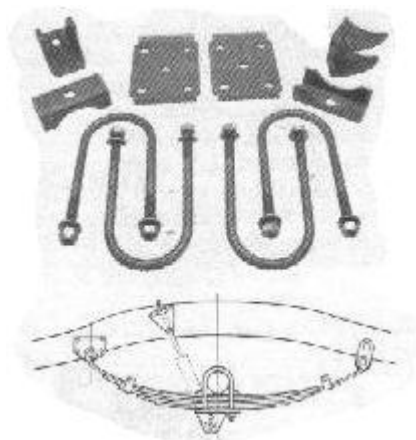

55-59 Rear axle conversion kit- use to update to later model 3" axle tube dia -- eg,F body rear ends

45-3RCK

Year

New

Used

55-59

\$139.95

45-3559-RAS axle seat -- pr

55-59

\$19.95

*Bill's Truck Shop*

Phone (905) 725-3460 / (905) 725-2022 / Fax (905) 404-2302 email: [bill@billstruckshop.com](mailto:bill@billstruckshop.com)

# Steering & Suspension

Due to the fluctuation of the Canadian and American dollars call for current prices

# Group 39

			<u>Year</u>	<u>New</u>	<u>Used</u>
		<b>39-0205-P</b>			
					
<b>39-301-FR</b>	<b>39-304-F</b>	<b>39-0206</b>			
					
<b>39-308</b>	<b>39-0227</b>	<b>39-0225</b>			
					
<b>39-0203-S</b>					
					
<b>39-314-55F</b>					
					
<b>39-0218</b>	<b>15-0560-BP</b>				
					
<b>39-316-R</b>					
					
<b>39-316-F</b>					
<b>Shackle Kit</b> -threaded pins, bushings, side plates & seals					
47-56 w/centre pin w/2" spring/57-59 w/ nut on bushing pin					
39-301-FR 47-55 1,1 1/2,2 ton front & 55-56 1/2. 3/4 ton w/2 " spring front and rear			47-56	\$74.95	
39-302-FR -Ft or Rr-1/2 or 3/4 w/ 2'spring			57-59	\$69.95	
<b>Spring Eye Bolt &amp; Bushing</b> at fixed end of spring					
39-304-F front 1/2 -3/4 /threaded nut w/ 2" spring			55-59	\$38.95	
39-304-R rear 1/2- 3/4 w/ notch lock w/ 2"spring			55-59	\$38.95	
<b>Lock Pin</b> -threaded & tapered					
39-0205-P secures rear spring eye bolt			55-59	\$15.95	
<b>Shackle Rubber Seals</b>					
39-0206 each			47-59	\$1.15	
<b>Rear Spring Shackle</b>					
39-0203-S cast iron support w/ new bushing-33-68 3/4 - 1 ton and 33-59 1 1/2 - 2 ton			each	33-68	\$124.95 \$75.00
<b>King Pin Set</b>					
39-308 std size .8660 x 5.312" 1/2 ton			55-59	\$159.95	
39-308-OS oversize .010 1/2 ton			55-59	\$159.95	
39-308-1 std- size diameter .921 3/4 & 1 ton			55-59	\$169.95	
<b>Grease/Zerk Fittings</b>					
39-0227 1/4-28 Pipe Thread 45 degree-each				\$7.90	
39-0225 1/4-28 Pipe Thread-straight----each				\$2.95	
<b>Shock Absorber Cylinder Type (gas)</b> pre check rear shock mount length required -note # of leaf springs ft & rear					
39-314-55F 1/2 - 3/4 ton front 12" closed/19" open					
55-56 Front 1/2, 3/4 & 1 ton			each	55-56	\$43.00
16-0008 1/2 - 3/4 ton front 12" closed/19" open			each	57-59	\$69.95
39-314-57R 1/2 - 3/4 rear 14" closed-23"open 1955-56 1/2 ton Longbed and 3/4 ton 1957-59 1/2 and 3/4 ton			each	55-59	\$89.95
<b>Axle Bumper</b>					
39-0218 47-55rear & 55-59 ft & rear			each	47-59	\$10.95
15-0560-BP universal application axle/frame /control arm bumpers polyurethane 2" tall			pair		\$36.95
<b>U-Bolts</b> w/ hardware					
39-316-F 5" long front w/ 2 " spring			each	55-59	\$14.95
39-316-R 7 1/2 long w/2" spring rear			each	55-59	\$14.95

## Bill's Truck Shop

Phone (905) 725-3460 / (905) 725-2022 / Fax (905) 404-2302 email: bill@billstruckshop.com

# Steering & Suspension

Due to the fluctuation of the Canadian and American dollars call for current prices

# Group 39

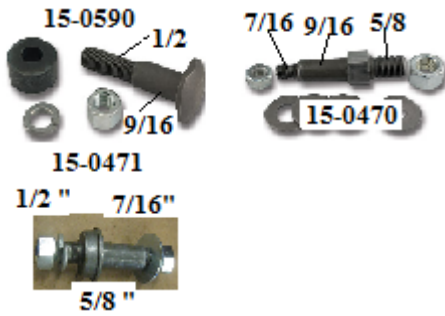

 **BTS EXCLUSIVE**



**BTS exclusive**



## Shock Bolt—check OE hole size

		<u>Year</u>	<u>New</u>	<u>Used</u>
15-0470	universal application	55-59	\$12.95	
15-0590	up & lower rear-- lower front and upper front w/ replacement support	55-59	\$9.50	
15-0471	universal application		\$9.95	

## Retainer/guide

39-0316-F	front spring u-bolt	each	55-59		\$5.00
39-0316-R	rear spring u-bolt	each	55-59		\$5.00

## Shock Absorber Mount Brackets

39-315-RU	rear upper fits L or R	each	55-59	\$44.95	\$20.00
39-315-RLL	rear lower 2 3/4 high	left	55-57		\$20.00
39-315-RLR	rear lower 2 3/4 high	right	55-57		\$20.00
39-315-RLL-58	rear lower 3 1/2 high	left	58-59		\$20.00
39-315-RLR-58	rear lower 3 1/2 high	right	58-59		\$20.00
39-315-FU	front upper w fits L or R	each			
	MUST add 15-0590 shock bolt		55-59	\$47.95	
39-315-FLL	front lower	left	55-59		\$20.00
39-315-FLR	front lower	right	55-59		\$20.00
39-315-F	ft lower shock bkt-fits L or R	each	55-59	\$34.95	

## Bill's Truck Shop

Phone (905) 725-3460 / (905) 725-2022 / Fax (905) 404-2302 email: bill@billstruckshop.com



# Steering & Suspension

Due to the fluctuation of the Canadian and American dollars call for current prices

# Group 39

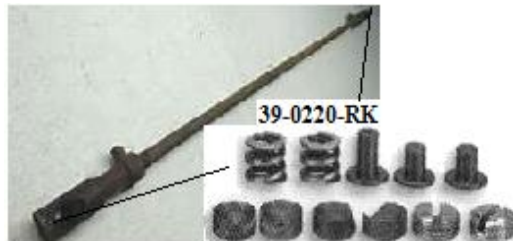
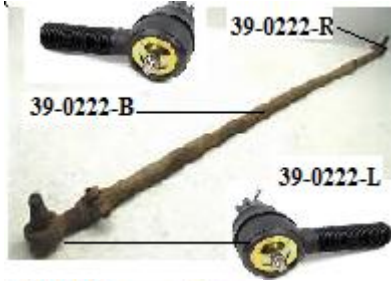
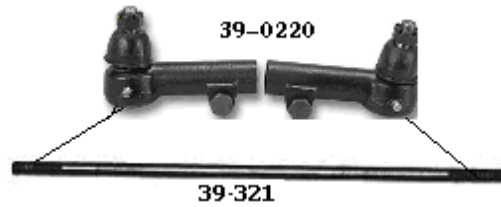

## Tie Rod Ends

39-0220 replacement type w/ female threaded ends-1/2 and 3/4 ton w/ solid male style bar pair

Year      New      Used

47-59      \$99.95

## Tie Rod Ends ---- NEW style w/ hollow style female bar

39-0222-L left tie rod end 34-59 \$69.95

39-0222-R right tie rod end 34-59 \$69.95

39-0222-B center hollow bar 47-55 \$40.00

## Tie Rod Repair kit and 41-52 drag link

39-0220-RK 1/2 - 3/4 & 1 ton for both sides 29-59 \$42.95

## Tie Rod Link -solid bar-threads must be cleaned before installing ends

39-321 threaded male bar between front wheels 55-59 \$69.95 \$30.00

## Tie Rod Ends ---- NEW style w/ hollow style w/ female bar 1/2 & 3/4--tapered shaft

39-0222-L left tie rod end 34-59 \$49.95

39-0222-R right tie rod end 34-59 \$49.95

39-0222-B center hollow bar 47-55 \$40.00

39-0035 1 & 1 1/2 ton left 34-59 \$84.95

39-0036 1 & 1 1/2 ton right 34-59 \$84.95

3.38 in Length; with .812 in x 18 Threads

39-0035/6 center bar-need measurement 34-59 \$100.00

## Steering Drag Link pitman arm to steering arm

39-323 fits 1/2- 3/4- 1 ton 55-59 \$159.95

## Power Steering Custom Drag Link

45-3559-DL custom drag link for 400 series power steering box—adjustable (helps correct steering return on turns)

55-59 \$144.95

## Ball Stud @ steering arm for tie rod

39-0225-2 ( 1/2shoulder ) at tie rod end 1/2 ton -each 34-59 \$29.95

39-0225-3 1/2 tapered shaft at tie rod end 3/4 ton - each 46-59 \$39.95

## Tie Rod Boot

39-0176 w 9/16 shaft diameter each \$5.95

39-0177 w 5/8 shaft diameter each \$5.95

## Bill's Truck Shop

Phone (905) 725-3460 / (905) 725-2022 / Fax (905) 404-2302 email: bill@billstruckshop.com

# Steering & Suspension

Due to the fluctuation of the Canadian and American dollars call for current prices

# Group 39



		<u>Year</u>	<u>New</u>	<u>Used</u>
<b>Steering Box –used sold as “AS IS “</b>				
<b>Rebuilt columns do not include new upper bearing- #18-0311-confirm if required—includes 5-0230-N Grease packed during assembly-no lube required-tube length- top of box casting to top of tube-OE ratio 24:1</b>				
			<b>Rebuilt</b>	
40-302-55	w / 3 speed column shift 36 1/2 “	55-56	\$395.00	\$150.00
40-302-55-4	w/ 4 speed floor shift 36 1/2	55-56	\$395.00	\$150.00
40-302-57	w / 3 speed column shift 33 1/2 “	57-59	\$395.00	\$150.00
40-302-57-4	w/ 4 speed floor shift 33 1/2		\$395.00	\$150.00
<b>Pitman-Sector Bushing kit</b>				
40-0056	2 brass bushing w/ seal	37-72	\$42.95	
<b>Pitman Shaft Nut w/ lock washer</b>				
40-0055-N	w/ manual steering box	37-72	\$4.00	
<b>Upper Column Bearing -</b>				
18-0311	with horn wire	47-59	\$84.95	\$35.00
<b>Steering Box Thrust Bearing upper &amp; lower</b>				
40-0790		41-59	\$44.95	
<b>Steering Box Rebuild Kit w/ , bushings shims, gaskets &amp; instructions does not include ball bearings</b>				
40-301-1		55-59	\$139.95	
<b>Steering Box Bearing set</b>				
40-0001	60 pcs 9/32 steel ball bearings		\$34.95	
<b>Steering Box Gasket set</b>				
40-0808	end cap & cover	41-46 & 55-59	\$9.95	
<b>Pitman Shaft Seal</b>				
40-0055		37-72	\$21.95	
<b>Steering Stabilizer Kit--improves steering --NEW design--anchors at REAR u-bolt of leaf spring &amp; drag link--improve steering ability, Kit includes stabilizer unit and mounting hdw--may require replacing 1 u-bolt ( 39-216-FR ) if it cannot be removed</b>				
40-0207		47-59	\$159.95	



## Bill's Truck Shop

Phone (905) 725-3460 / (905) 725-2022 / Fax (905) 404-2302 email: bill@billstruckshop.com

# Mounts & Hardware

Due to the fluctuation of the Canadian and American dollars call for current prices

## Group 40

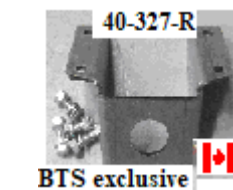
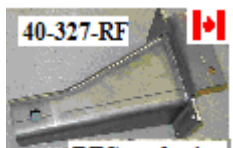
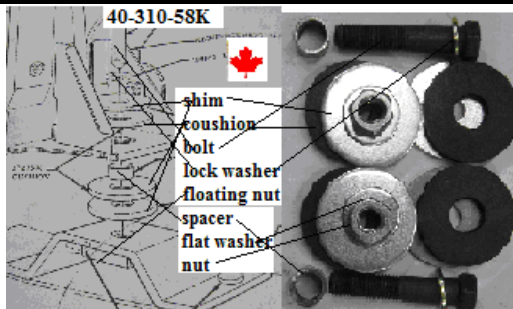

			<u>Year</u>	<u>New</u>	<u>Used</u>
<b>Radiator Support Mounting Pads</b>					
40-310	Chev	set of 4	55-59	\$6.95	
<b>Radiator Support Mount kit-includes bolts &amp; cushions, washers</b>					
40-310-55K			55-57	\$29.95	
40-310-58K	secures to square floating nut under stand-includes extra flat washer & lock nut if floating cage nut is missing or damaged		58-59	\$34.95	
<b>Cab Mount Kit With hardware</b>					
40-327		pickup	55-59	\$49.95	
40-327-1		panel or suburban	55-59	\$79.95	
<b>Cab Frame Support w/ hdw</b>					
40-327-LF		left front	55-59	\$149.95	
40-327-RF		right front	55-59	\$149.95	
40-327-R		left or right rear each	55-59	\$69.95	
<b>Front Motor Mounts</b>					
40-312-S		small cushion each	55-59	\$3.95	
40-312-L		large cushion each	55-59	\$3.95	
40-312-K		kit-8pcs	55-59	\$32.95	
40-312-CHK		4 outer washer w/ nuts & external tooth lock washers 8 pcs per side	55-59	\$7.95	
40-312-SV8		Engine mount stud w/V8 each	55-59	\$24.95	
40-312-6		upper engine support 6 cyl pr	55-59		Inquire
40-312-8		upper engine support V8 pair	55-59	\$44.95	
40-0312-G		8 cyl GMC front 1-up & 1 lower	55-59	\$99.00	
<b>V8 Conversion Kit</b>					
40-3V8		original style to install v-eight engine	55-59	\$259.95	
40-3V8-HK		correct bolts/ washers to install	55-59	\$15.95	

*Bill's Truck Shop*

Phone (905) 725-3460 / (905) 725-2022 / Fax (905) 404-2302 email: bill@billstruckshop.com

# Mounts & Hardware

Due to the fluctuation of the Canadian and American dollars call for current prices

# Group 40

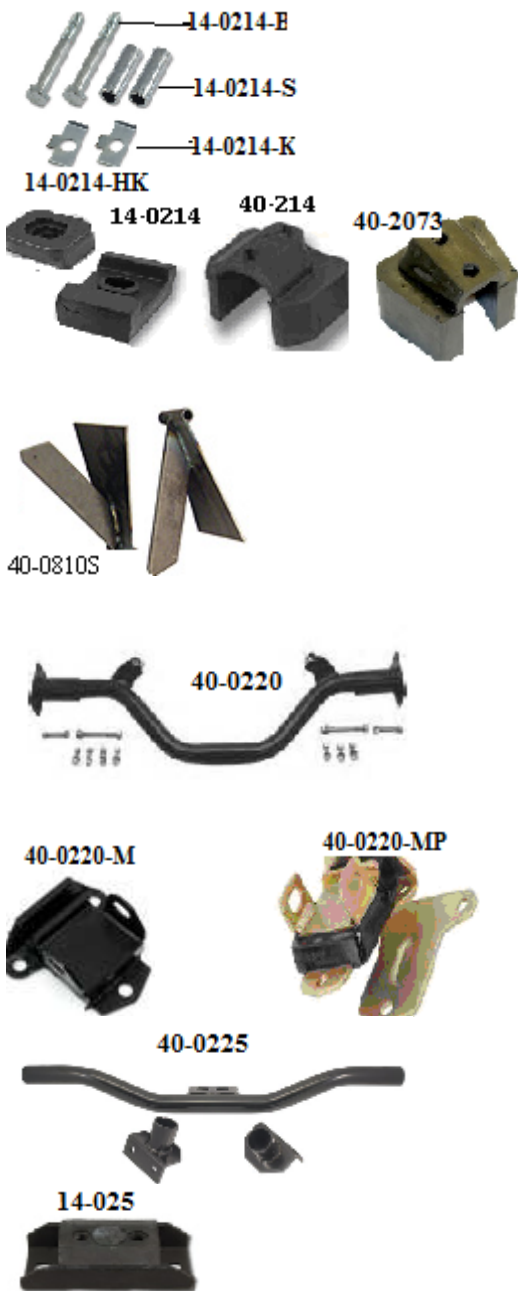

### Rear Mount hdw

			<u>Year</u>	<u>New</u>	<u>Used</u>
14-0214-K	keeper to secure through bolt-each		54-59	\$8.95	
14-0214-S	mount bolt spacer	-each	54-72	\$10.95	
14-0214-B	mount bolt	-each	54-72	\$2.00	

### Motor Mount Install hdw kit

14-0214-HK	sleeves/bolts & locks	6 pcs	2 sides	54-59	\$26.95
------------	-----------------------	-------	---------	-------	---------

### Rear Motor Mounts

14-0214	1 upper & 1 lower- also	54-59 aut trans	54-87	\$32.95	
---------	-------------------------	-----------------	-------	---------	--

40-2073	1937-1947 Chevrolet),(1939-1959 GMC) (1947-1953, 3/4, 1, 1 1/2, 2 ton Chevrolet and GMC).(1952 -1953 GMC with Hydromantic Trans (wedge shape-3 " wide)	each	37-59	\$29.95	
---------	--	------	-------	---------	--

### V8 Engine Frame bkts. Set-big & small block

40-0810S	weld to frame when installing Mustang II front suspension/ universal application-requires mount # 40-0220-M		47-59	\$109.95	
----------	---	--	-------	----------	--

### V8 Crossmember Adapts GM small block motors to early frames w/ hardware

40-0220			47-59	\$94.95	
---------	--	--	-------	---------	--

### V8 Motor Mount -----use w/ V8 kit 40-0220 & 40-0810S

40-0220-M	OE rubber	each	47-59	\$21.95	
40-0220-MP	Polyurethane, Zinc/Black	each	47-59	\$64.95	

### Transmission Crossmember Use to install standard or automatic trans.

40-0225			54-72	\$109.95	
---------	--	--	-------	----------	--

### Rear Transmission Mount Pad

14-025	use with std / PG / 350/700 trans			\$24.95	
14-025-1	turbo 400			\$24.95	

## Bill's Truck Shop

Phone (905) 725-3460 / (905) 725-2022 / Fax (905) 404-2302 email: bill@billstruckshop.com

# Engine – Rear Axle-Trans

# Group 41



41-0695

41-0788

41-0970



41-0055-K



41-0502-EL

41-0016



41-0410

41-0910



41-0225

41-0225-G



**Inquire about used rear ends 1/2 - 3/4 and gear ratio**

\$250.00

**Axle Seals-rear**

41-0695	1/2 ton each	38-62	\$39.95
41-081B	3/4 - 1 ton w/ out Dana rear axle-dana rear axle cover has straight sides-other axle has round cover	47-72	\$24.95

**Rear Axle Rebuild kit**-includes ft & rear pinion bearing w/ crush sleeve, pinion seal and 2 carrier side bearings, also includes gasket/cover is 10 bolt cover

41-0055-K		55-62	\$299.95
-----------	--	-------	----------

**Rear Axle Bearings**

41-0502-EL	outer 1/2 ton each	38-61	\$92.95
41-0503	outer bearing 3/4 and 1 ton	46-72	\$49.95
41-0504	inner axle bearing 3/4 and 1 ton	46-72	\$49.50

**Pinion Nut**

41-0016	7/8-16 thread- 1 1/8 OD		\$24.95
---------	-------------------------	--	---------

**Pinion Seal**

41-0788	1/2 ton w/ common spicer 44 rear end	55-62	\$47.95
41-0970	3/4 - 1/ ton- 1 1/2 ton- w/ open drive shaft	46-65	\$40.95

Pinion Bearing—spicer 44

41-01047

**Pinion Bearing**

41-0910	rear	55-62	\$89.95
41-0410	front	55-62	\$74.95

**Rear Axles 1/2 ton / inquire about 3/4-1 ton**

41-3500-L	17 spline left 30 1/8 long	55-59	\$175.00
41-3500-R	17 spline right 31 long	55-59	\$175.00

**Rear Axle Plug**

41-0225	1" w /gasket	47-63	\$19.95
41-0225-G	gasket (leather)	47-63	44.95

*Bill's Truck Shop*

Phone (905) 725-3460 / (905) 725-2022 / Fax (905) 404-2302 email: bill@billstruckshop.com



# Engine – Rear Axle-Trans

# Group 41

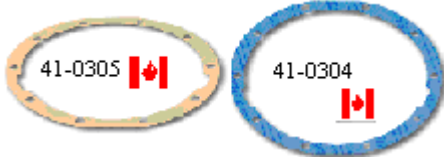

**Inquire about used rear ends 1/2 - 3/4 and gear ratio**

**Rear Axle Cover Gasket**

41-0304	1/2 - 3/4 10 bolt rear end	37-63 Chev		
	39-66 GMC 1/2 ton	1/16 (.063) thick	37-66	\$7.95
41-0088	3/4 - 1 - 1 1/2 H072-52 Eaton w/ 10 bolt cover		37-72	\$21.95

**Rear Differential Carrier Gasket**

41-0305	1/2 - 10 bolt rear end	37-63 & 37-45		
3/4 ton	39-70 1/2 GMC	1/32 (.031) th	37-63	\$7.95

**Rear Axle Vent @ some trans**

16-0270	plastic w/ cover	64-72	\$4.95
16-0271	metal screw in	47-63	\$24.95
16-0270-K	rear axle vent w/ hose	60-87	\$11.95

**Rear End Gear Kit raise your top speed**

41-0338	upgrade from 3.90 to 3.38 to 1 ratio ring and pinion, 1/2 ton- we suggest you add rebuild kit # 41-0055-K requires crown/carrier # 3697701	55-62	Inquire
Inquire	-Used CHEV 3:90 rear carrier assembly 1/2	55-69	\$250.00

**TOOL**

41-0TOOL pair of carrier adjust wrenches- available to borrow w/ return Inquire

**Sleeve-rear pinion crush/non posit**

41-0151		55-66	\$24.95
41-0152	1/2 w/ 8:75 rear end	66-81	\$16.50
41-0305	1/2 - 10 bolt rear end	37-63 & 37-45	
3/4 ton	39-70 1/2 GMC	1/32 (.031) thick	37-63 \$5.95

## Bill's Truck Shop

Phone (905) 725-3460 / (905) 725-2022 / Fax (905) 404-2302 email: bill@billstruckshop.com

**Dana-Spicer 45**

GMC trucks used Dana rears for many of the same applications where Chevy had Eaton. AFAIK, those Danas are a direct swap into Chevy trucks- the Dana has more highway-friendlier gearing.

Apart from the expected parts differences, the Dana also uses different brake drums.

Spicer/Dana 44 rear axles are identified by a casting number stamped into the webbing on the front of the differential case to the driver's side of the driveshaft. Front axles have a model number cast just below where the right-side axle tube connects to the differential. On this same axle tube, you will find a build date and a bill of materials number stamped into the body of the tube. This bill of materials number is important for ordering replacement parts and identifying what the differential originally came out of. The number will be six digits long with a seventh number after a dash. The last digit identifies the ring and pinion ratio at the time of production. A complete list of the bill of materials numbers for both Dana 44s and Dana 60s is available on the parts locator

Chevys had the 3.90 rear gears; GMCs had the 3.91 (or 3.92?) gears.

First figure out what rear end you have. Chevy rear end is the HO33 it has a round, removable rear cover, AND a drop out center section.

The GMC should have a Spicer/Dana 45 which has a removable rear cover, and you can't take the pumpkin out. The cover is shaped kind of like a stop sign.

**1955-59 1/2 Chev rear  
end**



**Inquire about used rear ends 1/2 - 3/4 and gear ratio**

**DANA REAR ENDS**

**Axle Seals-rear**

**Rear Axle Bearings**

**Pinion Seal**

**Rear Axle Cover Gasket**

**Rear Differential Carrier Gasket**

**Rear Axle Plug**

**Rear Axle Vent**

***Bill's Truck Shop***

**Phone (905) 725-3460 / (905) 725-2022 / Fax (905) 404-2302 email: bill@billstruckshop.com**

# TRANSMISSION

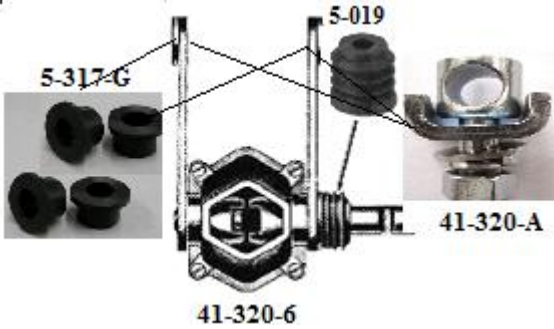

## Shift Linkage Adjuster

41-320-A each 55-59 \$18.95

## Shift Box

41-320-6 6 cyl 55-59 \$50.00

41-320-8 8 cyl 55-59 \$50.00

## Shift Rod Grommet @ box & trans

5-317-G set of 4-rubber 55-59 \$6.50

## Shifter Boot at shift box

5-019 47-59 \$3.95

Inquire about used trans and trans parts-  
shift linkage etc.

## Transmission-gear speedometer

41-0000 inquire - most 4 speed and  
# of teeth screws into tailstock \$25.00

41-0000-1 2 5/8 long secures w/ lock tab \$20.00

41-0200 1 7/8 " long secures w/ lock tab \$39.95

63-87-- 350 aut -2 speed powerglide & some 3-4  
speed Saginaw transmission speedometer driven  
gear-less teeth to increase odometer MPH 63 up  
2" long & 62 and under 3" long

## 3 & 4 speed std-power glide/350

41-0221-18 Speedo driven gear-brown  
w/ 18 teeth \$12.95

41-0221-19 Speedo driven gear- white  
w/19 teeth \$12.95

41-0221-20 Speedo driven gear-dark  
blue w/20 teeth \$12.95

41-0221-21 Speedo driven gear-red  
w/21 teeth \$12.95

41-0221-22 Speedo driven gear-green  
w/22 teeth \$12.95

41-0221-24 Speedo driven gear-yellow  
w/24 teeth \$12.95

41-0221-25 Speedo driven gear-natural  
w/25 teeth \$12.95

Retainer-Speedo drive gear-350-400-460 \$9.00

41-0222-20 Speedo gear-metal 3 " long  
w/ 20 teeth inquire about others \$20.00

*Bill's Truck Shop*

Phone (905) 725-3460 / (905) 725-2022 / Fax (905) 404-2302 email: bill@billstruckshop.com

# TRANSMISSION

41-0SM420-TS SM420 4 speed trans



41-03305



The SM-420 4-speed transmission was produced by General Motors between the years of 1947 & 1967. Starting in 1966 General Motors offered the NP-435GA for its light truck applications as an option. The NP-435-GA became the standard 4-speed sometime in the late 1960s. The cast iron case with large bulge on the passenger side makes the SM-420 easy to identify. Ribbing was added to the bulge on later cases. The ribbed SM-420 case should not be confused with the later SM-465 transmission. How can you tell which 4-speed your 1966 has, if reverse is to the driver & down, it's the SM-420, if to the passenger & down

## SM420 4 speed transmission parts

Tailstock/rear yoke seal

41-0SM420-TS		47-67	\$38.95
--------------	--	-------	---------

Bearings-transmission

41-03305	main shaft rear ---3 speed	37-54	\$69.95
----------	----------------------------	-------	---------

41-03207	ft input bearing---3 speed	38-67	\$62.95
----------	----------------------------	-------	---------

*Bill's Truck Shop*

Phone (905) 725-3460 / (905) 725-2022 / Fax (905) 404-2302 email: [bill@billstruckshop.com](mailto:bill@billstruckshop.com)

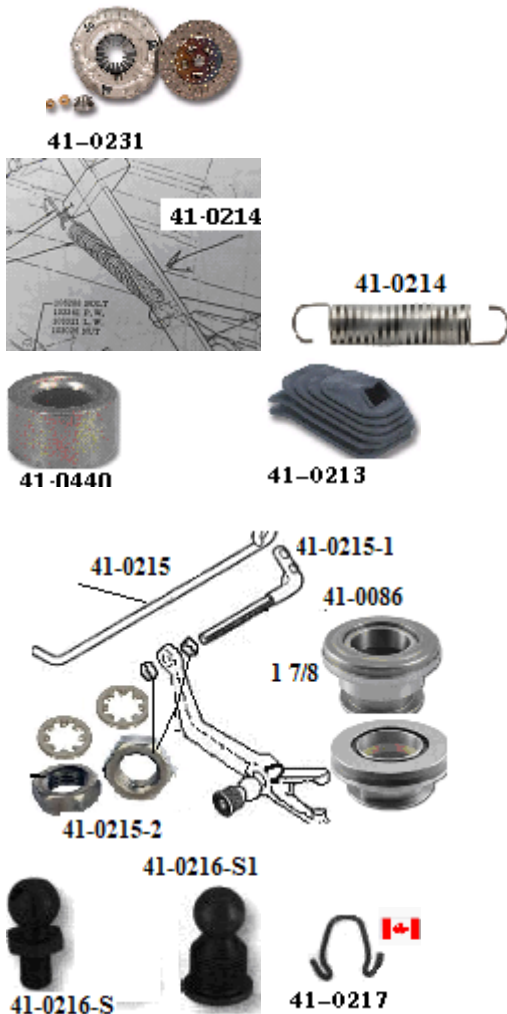

	<u>Year</u>	<u>New</u>	<u>Used</u>
<b>Clutch---match w/ removed parts</b>			
41-0231 NEW 10 1/2" clutch w/ pressure plate release bearing. pilot bushing all w/ 3 speed transmission includes 1 7/8 bearing	54-62	\$325.95	
41-0072 NEW 11 clutch kit w/ 4 speed trans - Spline: dia 1 1/8 w/ 10 spline includes 1 7/8 bearing,,bushing & align tool	51-62	\$239.95	
<b>Clutch Release Bearing</b>			
41-0086 6 cyl & most V8 1 7/8 long	38-75	\$79.95	
41-0087 1 1/4 long	47-84	\$64.95	
<b>Clutch Fork Boot-replacement type for newer style bell housing</b>			
41-0213	63-72	\$14.50	
41-0213-A original style w/ spring retainer	47-59		inquire
<b>Pilot Bushing</b>			
41-0440 brass- fits 6 & 8 cyl	47-87	\$19.95	
<b>Clutch Pedal Return Spring @ clutch offset rod</b>			
41-0214	47-59	\$5.95	
<b>Clutch Linkage Rod</b>			
41-0215	47-59	\$17.95	
<b>Clutch Linkage Offset Rod</b>			
41-0215-1 includes 2 adj nuts	47-72	\$27.95	\$10.00
<b>Nuts-Jam nut for clutch adjust rod-pr</b>			
41-0215-2 pair of adjusting nuts w/ washers	47-59	\$3.50	
<b>Clutch Fork</b>			
41-0218-F	47-59		\$15.00
<b>Clutch Fork Ball Stud</b>			
41-0216-S 3/8" stud-6 cyl only	38-59	\$15.95	\$5.00
41-0216-S1 3/4" shaft-V8 only	55-72	\$22.85	\$5.00
<b>Clutch Fork Stud Retainer Clip</b>			
41-0217	38-72	\$14.95	
<b>Flywheel</b>			
41-0409 6 cyl engine ( casting # 3705409) 1955-'62 cars and trucks with 10 1/2-inch clutch and 168-tooth ring gear---used flywheels are resurfaced	55-62		\$175.00
41-00410 6 cyl engine ( casting # 3709410 & 3789730) 1955-'62 cars and trucks with 11-inch clutch and 168-tooth ring gear---used flywheels are resurfaced w/ 4 speed trans	55-62		\$175.00

*Bill's Truck Shop*

Phone (905) 725-3460 / (905) 725-2022 / Fax (905) 404-2302 email: bill@billstruckshop.com





### Automatic Column Shift Linkage kit

3-0TSL-L universal-upgrading to auto trans 47-72 \$114.95

### Bell Housing

41-3BH 3 & 4 speed trans 55-59 \$40.00

### Flywheel Cover-front upper

36-0908 3 & 4 speed trans 55-72 \$44.95 \$20.00

### Flywheel Cover-lower

41-0477 3 & 4 speed 55-72 \$87.95 \$30.00

### U-joint Retainer

41-0021 1 3/8 center to center each \$10.95

41-0022 1 1/2 center to center each \$10.95

41-0023 1 3/4 center to center-metric each \$11.95

### Driveshaft U-joint

41-0369 U-joint w/ 3 speed or automatic 1/2 ton each 55-87 \$39.95

41-0331 U-joint w/ 4 speed @ trans (3 5/8 dia w/ 1 3/16 cup) each 55-87 \$36.95

### Driveshaft Hanger Bearing Assembly

14-030-S 1.3780" ID 54-94 \$71.95

54-94 Support Driveshaft hanger bearing w/ side to side mount

*Bill's Truck Shop*

Phone (905) 725-3460 / (905) 725-2022 / Fax (905) 404-2302 email: bill@billstruckshop.com

# Engine

# Group 41



		<u>Year</u>	<u>New</u>	<u>Used</u>
<b>Carburetor</b>				
41-0231-54	Rochester 2 15/16 stud spacing	54-59	\$295.00	\$50.00
41-3V8	rebuilt v8 carburetor Chev ---\$60.00			
	core charge when core	55-59	NLA	
41-3V8-C	core charge for above carb	55-59	\$60.00	
<b>Carburetor Insulation Plate</b>				
41-0231-1	-2 15/16 mount	54-62	\$11.95	
<b>Carburetor Insulation Plate Gasket</b>				
41-0231-G	-2 15/16 mount	54-62	\$3.95	
<b>Carburetor Rebuild kit</b> -includes gaskets, accel pump, needle w/ seat & instructions NO float				
41-0158	Rochester 6 cyl	50-62	\$47.95	
<b>Carburetor Float</b>				
41-0095	Rochester w/ 6 cyl	41-62	\$34.95	
<b>Distributor Vacuum Advance</b>				
41-0DVA	6 cyl	37-62	\$64.95	
<b>Oil Filter Assembly w/ bkt</b> 6cyl				
41-0201-A		47-62		\$75.00
<b>Oil Filter Lines (pair)</b>				
41-0249L	6 cyl	47-62	\$64.95	
<b>Oil Line Block kit</b> - 4 pc set				
41-0249-A	2 outlet plug for oil gauge and filter line-screws in block	47-62	\$19.95	
41-0249-1	1/8 pilot nut		\$2.35	
41-0249-2	1/8 tube OD x 1/8 male pipe		\$4.70	
41-0249-3	1/8 NPT 3 outlet female		\$4.95	
41-0249-4	1/8 x 1" connector tube		\$2.35	
<b>Cartridge Oil Filter</b> The Fram cannisters use a 7/8" wrench on the top bolt and have a crimped bottom/ black top & orange canister-fram # C4 or C4P2 The A/C cannister uses a 5/8" wrench on the top bolt and has a smooth bottom.				
				<b>Inquire</b>
41-0201-1	4 1/8 W x 5 H FRAM	37-62	\$29.95	
41-0201-2	4 1/2 W x 5 H AC	37-62	\$23.65	
41-0201-GMC	3 1/2 x 3 7/8 H GMC ONLY			
	located on right ft of 6 cyl engine	39-59	\$22.95	
<b>Oil Filter Adaptor</b>				
41-0461	early SB V8 --- to convert from cannister filter to spin	56-68	\$69.95	

*Bill's Truck Shop*

Phone (905) 725-3460 / (905) 725-2022 / Fax (905) 404-2302 email: bill@billstruckshop.com

# Engine

# Group 41



### Accelerator Return Spring

41-0208 6cyl 50-59 \$8.95

### V8 Throttle Linkage original type

41-0310 47-52 requires 55-57 gas pedal 47-59 \$89.95

### Starter Pedal Return Spring

41-0211 6 cyl 47-59 \$5.50

### Starter Linkage at bell housing 6 cyl

41-0212 50-59 Inquire

### Spring-Starter pedal return

41-0211 47-59 \$4.50

### Link-Starter pedal return

41-0211-L 47-59

### Rod-Starter pedal @ starter

41-0211-R 47-59

### Tension spring kit-starter pedal rod

41-0211-K 47-59 \$2.95

### Dip Stick w/ tube

41-0299 v8 small block OE design-STEEL always confirm correct amount of oil to stick marks 58-74 \$34.95

### Clips-vac & fuel

41-0195 3 pcs set secures dist vac line to fuel line 37-62 \$12.95

### Cam Gear-fibre type

41-0500 Cam Gear-216/228/235/248/270 42-62 \$84.95

*Bill's Truck Shop*

Phone (905) 725-3460 / (905) 725-2022 / Fax (905) 404-2302 email: [bill@billstruckshop.com](mailto:bill@billstruckshop.com)

41-3VC-G



41-020.B



41-020F-1



41-3 AC-2



41-3AC-3



41-020A



41-3AC-4



41-0201-49

41-0201-54

41-0741



41-0301-55

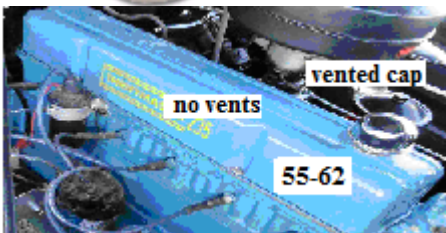

### Oil Filter Decals

41-020F-1 W/ Fram type -- 6 cyl engine  
 41-030F-2 55-62 A/C type w/ 6 cyl & 1955  
 V8 w/ remote filter

Year New Used

47-59 \$9.95

47-62 \$8.95

### Generator Warning tag

41-0GT 47-59 \$2.95

### Engine Decals Valve Cover

41-3VC-C Chev 6 cyl new-Thrift master 55-59 \$10.95

41-3VC-G GMC---orange details 55-59 \$9.95

41-3VC-GV8 GMC V 8 pair---yellow details 55-59 \$16.95

### Air Cleaner Decals

41-020B dry element style 47-59 \$2.95

41-020A oil bath type / angle style top -AC heavy duty 47-59 \$4.95

41-3AC-2 oil bath style w/ 6 cyl 55-60 \$7.95

41-3AC-3 oil bath style w/ 8 cyl w/ 2 bl 55-59 \$7.95

41-3AC-4 v8 w/ 2 bl carb 55-60 \$2.95

### Air Breather Wing Nut

41-0741 1/4 x 20 40-66 \$0.75

41-0741-10 #10 x 32 40-66 \$1.95

### Oil Filler Cap

41-0201-49 on valve cover -twist on-not vented 49-78 \$7.50

Check valve cover for vent slots -use non vented cap if cover has vents slots & vented cap w/ no vent slots in cover

41-0201-54 6 cyl 54-67 \$10.95

41-0301-55 8 cyl 55-72 \$11.95

### Valve Cover

6 cyl w/ Chevrolet embossed 55-62 Inquire

*Bill's Truck Shop*

Phone (905) 725-3460 / (905) 725-2022 / Fax (905) 404-2302 email: bill@billstruckshop.com

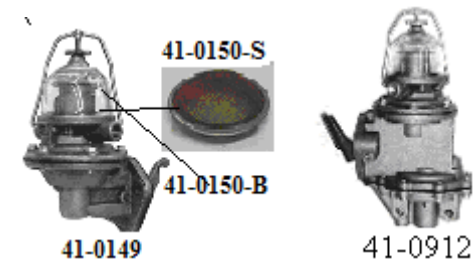
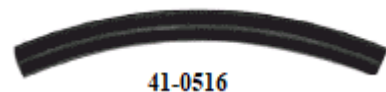

### Gas Filter Assembly-OE GM option

41-0668 glass bowl w/ filter -mount at carb 40-62 \$37.95 \$15.00

### Gas Filter Fitting hdw kit- installing at carb

41-0668-H 1 x 1/2 pipe—1 x straight -- 1x 90 deg line adaptor—for straight or side pipe install 40-62 \$19.95

### Gas Filter

41-0668-F filter for glass assembly 40-62 \$8.95

### Gas Filter Gasket

41-0668-G neoprene seal for glass bowl 40-62 \$5.50

### Fuel Hose

41-0516 5/16 neoprene hose ----per foot \$3.49

41-038 3/8 neoprene hose ----per foot \$3.49

### Fuel Pump

41-0149 w/ glass bowl type- 6 cyl 37-57 \$179.95

41-0429 w/o glass bowl 37-62 Chev/39-59 GMC when using this pump there should be a filter assembly @ carb #41-0668-also may require upper dis to line up pipe in and outlet holes OE style 37-62 \$119.95

41-0429-R w/o glass bowl 37-62 Chev/39-59 GMC when using this pump there should be a filter assembly @ carb #41-0668—this is a newer replacement style 37-62 \$74.95

41-0912 vac/fuel pump combination 39-59 GMC & 37-62 Chev 37-62 \$159.95

41-0005 vac/fuel combination-6cyl 58-62 \$115.00

41-0006 261-GMC & 235 -6 cyl w/ electric wipers 58-62 \$67.95

### Fuel Pump Rebuild kit

41-0149-RK glass bowl AC fuel pump 37-62 \$139.95

### Fuel Pump Bowl-glass

41-0150-B 41-62 \$10.00

### Fuel Pump Bowl-screen

41-0150-S brass inlet filter in bowl 41-62 \$10.00

### Fuel Pump Fitting-in and out let pipe

41-0148---fitting 1/8 NPT male x 5/16 tube OD \$3.25

*Bill's Truck Shop*

Phone (905) 725-3460 / (905) 725-2022 / Fax (905) 404-2302 email: bill@billstruckshop.com



# Engine-Trans Gaskets

Due to the fluctuation of the Canadian and American dollars call for current prices

# Group 41

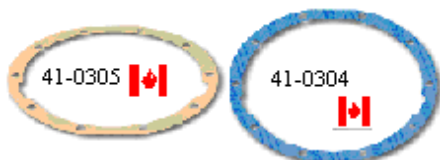

### Transmission Gasket Set

41-03TG-3 3 speed Muncie 318  
41-02TG-4 39-72 SM420 & 48-65 Muncie 4-speed

### Transmission Tailstock Seal w/ Bushing

41-0054  
Tailstock seal  
41-0041

Year      New      Used

55-66      \$44.95

39-72      \$29.95

55-72      \$42.95

### Rear Axle Cover Gasket

41-0304 1/2 - 3/4 10 bolt rear end 37-63 Chev  
39-66 GMC 1/2 ton 1/16 (.063) thick

37-66      \$6.95

### Rear Differential Carrier Gasket

41-0305 1/2 - 10 bolt rear end 37-63 & 37-45  
3/4 ton 39-70 1/2 GMC 1/32 (.031) thick

37-63      \$5.95

## Bill's Truck Shop









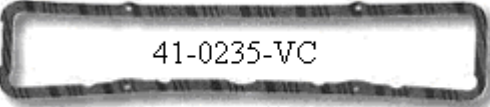

Phone (905) 725-3460 / (905) 725-2022 / Fax (905) 404-2302 email: bill@billstruckshop.com

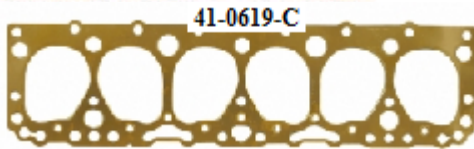

# Engine-Trans Gaskets

Due to the fluctuation of the Canadian and American dollars call for current prices

# Group 41

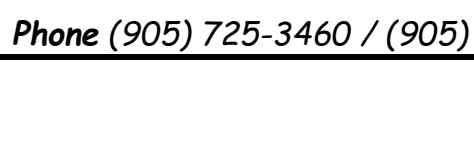
		<u>Year</u>	<u>New</u>	<u>Used</u>
	<b>Oil Pan Gasket set</b>			
41-0PG-55	41-0PG-55 235 engine	55-62	\$46.95	
	<b>Valve Cover Gasket</b>			
41-0235-VC	41-0235-VC 216-235 w/ side mount bolts	53-62	\$34.95	
	41-0228-VC 228/236/248/270/302 GMC 6 cyl	39-62	\$39.95	
	<b>Side Cover Gasket</b>			
41-0235-SC	41-0235-SC 216-235 engine- push rod cover	53-62	\$24.95	
	41-0228-SC GMC 228/236/248 6 cyl	39-62	\$25.95	
	<b>Intake Manifold Alignment Sleeves</b>			
41-0619-C	41-0205 34-53 207 & 216 Chev CI engine/41-49 235 Chev engine / 39-59 GMC engine	34-59	\$14.95	
	41-0205-1 235 & 261 CI Chev engine	50-62	\$16.95	
	<b>Intake-Exhaust Manifold to Cyl Head set</b>			
41-0069-53	41-0185 includes between intake & exhaust ,pipe to manifold etc 235 engine	50-62	\$38.95	
41-0930 41-0075	<b>Head Gasket 235 6 cyl engine</b>			
	41-0619-C NEW copper style-re-torque after running	53-63	\$84.95	
	41-0619	53-63		
	<b>Thermostat Gasket</b>			
41-0930	41-0930 all 6 or 8 cyl		\$3.95	
	<b>Thermostat Housing to Block Gasket</b>			
41-0068	41-0068 216--235	37-62	\$3.50	
41-0235-SC	41-0235-SC 216-235 engine- push rod cover	53-62	\$17.95	
	<b>Water Pump to Block Gasket</b>			
41-0069-53	41-0069-53	53-62	\$5.95	
	<b>Rear Main Seal-upgrade/neoprene</b>			
41-02RM-B	41-02RM-B OE rope style	40-62	\$19.95	
41-0363	41-0363 replaces the OE rope seal 235-261 6 cyl	55-62	\$89.95	
41-0711	41-0711 replaces the OE rope seal 265-283 V8	55-58	\$39.95	
	<b>Timing Cover Gasket set 228/236/248/270-52-59-302</b>			
41-0114-TC	41-0114-TC includes fit crank seal ( 1pc)	37-62	\$59.95	
	<b>Timing Cover Crank Seal</b>			
41-0842	41-0842 1 pc	37-62	\$27.95	
	<b>Balancer Repair kit</b>			
41-0919	41-0919 corrects groove-sleeve 6 cyl-SB v8	47-87	\$29.95	
	<b>Fuel Pump Gasket</b>			
41-0075	41-0075 6 & 8 cyl		\$3.00	
Push Rods	Push Rods 235 6 cyl			
41-0031	41-0031 10.444 Inch long set of 4	54-62		

*Bill's Truck Shop*

Phone (905) 725-3460 / (905) 725-2022 / Fax (905) 404-2302 email: bill@billstruckshop.com

# Exhaust

Due to the fluctuation of the Canadian and American dollars call for current prices

# Group 41

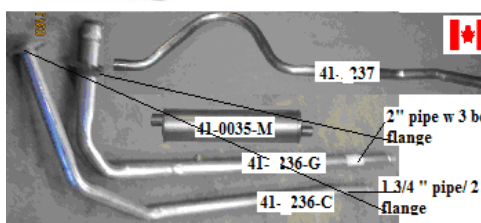
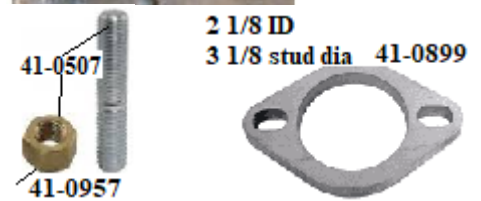
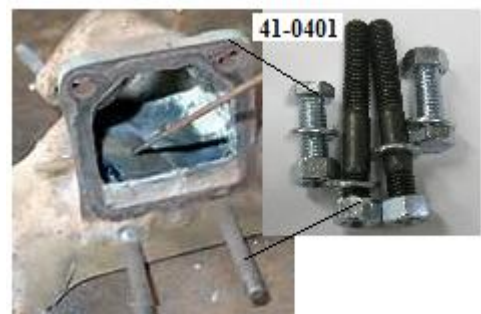

		Year	New	Used
<b>Exhaust to Intake bolt kit</b>				
41-0401	2 bolts ( 1 ¼ ) & 2 studs ( 3 ¼ ) w/ hdw		\$9.95	
<b>Exhaust pipe to manifold stud</b>				
41-0507	one stud ( 2 ½ long) w/ deep brass nut --each		\$9.80	
41-0957	3/8 – 16 brass nut pr		4.95	
<b>Heat Riser Spring</b>				
41-0206	6cyl	38-63	\$32.95	
<b>Heat Riser Gasket SB-V8</b>				
36-0350-G		55-85	\$3.95	
<b>Exhaust Gasket-donut</b>				
41-0400	6 cyl ft pipe to manifold 2" ID		\$5.95	
<b>Exhaust Clamp</b>				
41-0134	1 3/4		\$2.00	
41-0200	2 00		\$3.30	
41-0218	2 1/8		\$3.30	
41-0025	2 1/4		\$4.45	
<b>Exhaust Flange</b>				
41-0899	3 1/8 center to center on stud		\$15.95	
<b>Muffler Strap w/ hook</b>				
41-0235-SH		40-59	\$13.95	
<b>Tailpipe Hanger</b>				
41-0135		47-59	\$18.95	
<b>Universal Exhaust Hanger</b>				
41-0103			\$17.50	
<b>Front Pipe—for short bed –see ext for long bed</b>				
2" pipe	6 cyl Chev w/ 2 hole flange	Coming	\$118.95	
2" pipe	6 cyl GMC w/ 3 hole flange	Coming	\$149.95	
<b>Tailpipe</b>				
1 ½ pipe	6 cyl Chev & GMC w/ turn down end to exit below rear bumper –short step	Coming	\$109.95	
1 ½ pipe	6 cyl Chev & GMC w/ turn down end to exit below rear bumper –long step	Coming	Inquire	
<b>Muffler</b>				
41-0035-M	21"L x 5"W 2" inlet & 1 ½ outlet	40-59	\$89.95	

## Bill's Truck Shop

Phone (905) 725-3460 / (905) 725-2022 / Fax (905) 404-2302 email: bill@billstruckshop.com

# Engine – Cooling System

# Group 41

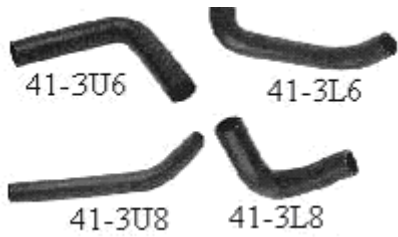

		<u>Year</u>	<u>New</u>	<u>Used</u>
<b>Radiator Hoses-</b> moulded hoses-235 6 cyl				
41-3U6	upper 1 1/2 size Chev w/ 6 cyl	55-59	\$29.95	
41-3L6	lower 1 3/4 Chev w/ 6 cyl	55-59	\$42.95	
41-3U8	upper 1 1/2 size Chev w/ 8 cyl	55-59	\$39.95	
41-3L8	lower Chev w/ 8 cyl	55-59	\$39.95	
41-02HU-B	upper 1 1/4 248/270 GMC w/ 6 cyl	55-59	\$22.95	
41-3L6-G	lower 248/270 GMC w/ 6 cyl	55-59	\$45.95	



<b>Heater Hose</b> –approx 3.5 to 4 ft required to secure on inner fender-MOST heater hoses are 3/4-CONFIRM				
18-0401	5/8 black-per foot		\$2.00	
18-0402	3/4 black-per foot		\$2.00	



<b>Heater Hose Retainer w/ screw</b>				
22-0205	original used- on pass inner fender	40-59	\$21.95	\$10.00
22-0205-1	heater or acc AC line retainer	40-87	\$5.00	

<b>Heater Hose Clamps</b>				
41-0220	1 1/2 “-1 3/4 screw type	each	\$0.95	
41-0220-0	up to 1 “ flat	each	\$3.25	

<b>Radiator Hose Clamps</b> OE style screw clamps				
41-001-3/4	OE style upper 1 3/4	each	\$6.95	
41-002-0	OE style lower 2”	each	\$7.95	
41-0220	1 1/2 - 2” screw type			
41-0228	1 3/4”-2” wrap- screw type	each	\$2.50	
41-004-3	2 1/16 – 2 1/4 OE style		\$7.95	
41-0044	2 1/16 – 2 1/4 wrap screw type			

<b>Radiator Cap</b>				
41-0RC-7	7 lb OE Delco	55-62	\$19.95	
41-0RC-7B	7 lb replacement	55-62	\$12.95	
41-0RC-16	16 lb rad cap for non stock engine application	47-87	\$13.95	

*Bill's Truck Shop*

Phone (905) 725-3460 / (905) 725-2022 / Fax (905) 404-2302 email: bill@billstruckshop.com

# Engine - Cooling System

# Group 41

Used



18-0160



18-0425-B

### Thermostat

18-0160	160 deg	\$14.95
18-0180	180 deg	\$14.95
18-0195	195 deg	\$14.95

### Fan Blade

41-0FB-6	6 cyl	55-62	\$25.00
41-0FB-8	8 cyl	55-59	\$25.00

41-0FB-6



### Fan Belt

41-03FB-1	Chev w/ 3/8 groove pulley 6 cyl-31 1/64 x 41 3/8	55-62	\$42.95
41-03FB-2	GMC w/ 3/8 groove pulley 6 cyl	39-59	\$19.95
41-03FB-3	GMC w/ 5/8 groove pulley 6 cyl	39-59	\$29.95
41-03FB-4	GMC w/ 3/4 groove pulley 6 cyl	39-59	\$19.95
41-3FB-5	Chev w/ v8 engine 55" long	55-59	\$39.95

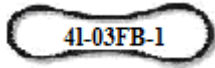

41-03FB-1



41-0453



41-0454

### Thermostat Housing

41-0453	V8 engine aluminum w/ gasket front/up	\$39.95
41-0454	V8 engine/aluminum w/gasket-angle	\$24.95
18-0425-B	Base- thermostat housing 216-235 6 cyl	40-62 \$69.95

18-00HA-2



### Hose Adaptors

18-00HA-1	Hose adaptors -adjusts from 1 3/4 to 2"	\$11.95
18-00HA-2	Hose adaptors -adjusts from 1 1/2 to 1 3/4"	\$11.95

41-0034



41-0058



41-0034-L



41-0058	5/8 hose fitting 1 1/2' long	\$11.95
41-0034	3/4 hose fitting 1 1/2' long	\$11.95
41-0034-L	3/4 hose fitting 2 1/2' long	\$11.95

*Bill's Truck Shop*

Phone (905) 725-3460 / (905) 725-2022 / Fax (905) 404-2302 email: bill@billstruckshop.com



# Engine - Radiator

# Group 41

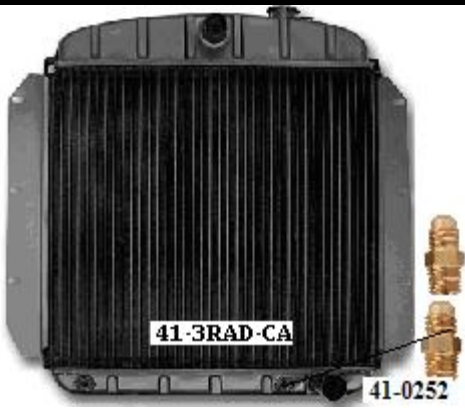

**Radiator-** OE style replacement modern tube-fin type cores w/side support brackets-1 1/2 top & 1 3/4 lower outlet dia. **COPPER-BRASS**

Year      New      Used

Please use correct lb rad cap

*W/O TRANS COOLER* 3 row cooling

**Rad**

41-3RAD-C 6 & 8 cyl w-std trans Chev  
w 19 7/8 x 21 3/8 x 2 core

55-59      Inquire

41-3RAD-G 6 & 8 cyl w/ std trans GMC  
w 19 7/8 x 21 3/8 x 2 core

55-59      Inquire

41-3RAD-G1 6 & 8 cyl w/ std trans GMC  
w 19 7/8 x 23 x 2 core

55-59      inquire

*With AUT TRANS COOLER* w/ 3 row cooling tubes

41-3RAD-CA 6 & 8 cyl w-aut trans Chev  
w 19 7/8 H x 23 3/8 W x 3 core-**requires fittings**

55-59      \$689.95

# 41-0252 when installing auto trans copper-brass  
41-3RAD-GA 6 & 8 cyl w-aut trans GMC  
w 19 7/8 x 21 3/8 x 2 core

55-59      Inquire

**Trans Cooler Auto Fittings**-required w/ aut lines

41-0252 12 x 1/2 x 1/4 NPT 9/16 drive pair

\$9.95

### NEW ALUMIMUM - not polished

. These radiators are high efficiency cores with 1" cores. Core size is 19 1/4" x 22 3/4". X 2" thick Inlet is 1 1/2". Outlet is 1 3/4". These are welded construction there is no epoxy used in these radiators.--**Transmission Cooler Included** (1/2"-20 Straight Thread, inverted flare

41-3RAD-CA-B 3 row w/ auto cooler,14 lb rad cap V8 application

55-59      \$424.95

41-3RAD-CA-LS ALUMINUM - w/ LS engine update radiators are high efficiency 3 row cores for maximum cooling. w/steam blow outlet all on pass side--

55.59      \$449.95

41-3RAD-CA-2B 2 row w auto cooler 14 lb cap 6 cyl----- Core--19.38" tall x 21.75" wide x 1.75" thick-- Inlet is 1 1/2". Outlet is 1 3/4".--allows clearance for the 235 fan-rad 6 cyl application -- **please confirm engine & trans mounts are in good condition-fan sits close to rad**

55-59      \$349.95

### Fan Shroud

41-3FS-1 aluminum shroud accepts 1 single 16"electric fan 19 1/3 H x 21 3/4 W

55-59      \$149.95

41-3FS universal/plastic-side mount

55-59      \$114.95

### Fan Shroud-OE style w/ manual fan

41-3FS-55 Chev w/ v8

55-57      Inquire

41-3FS-58 Chev w/ v 8

58-59      Inquire

### Hose-rad overflow drain 30" 3/8 thin walled-ribbed hose

10-00FH

\$9.95

### Radiator Petcock

41-0254 1/2 pipe

brass 40-87      \$8.95

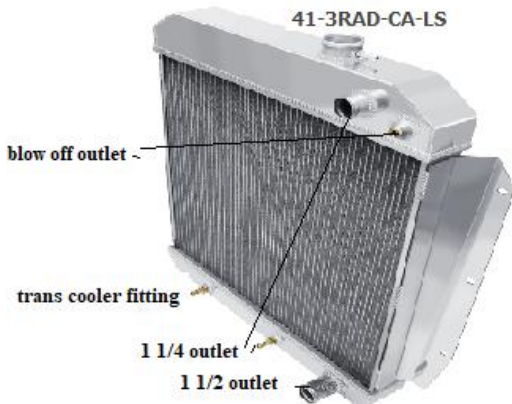

*Bill's Truck Shop*

Phone (905) 725-3460 / (905) 725-2022 / Fax (905) 404-2302 email: bill@billstruckshop.com



### Electric Fan

**44-0016** Produces a TRUE 2300 CFM Rating at 18.4 or 14 amp draw.

- This fan is 3 1/4" deep through the center of the motor; it gradually thins to 1 1/2" at the outer edge
- Curved blades are quiet and push the same amount of air as a straight blade.
- Factory built as a puller, mounted inside and pulls the air through the radiator.
- 12V REVERSIBLE 'S' BLADE - Blades & polarity of the wiring can be reversed & it becomes a pusher

universal \$99.95

**44-0014** 13.82 " wide//2 58 " deep 1750 CFM  
12 V 90 W reversible

universal \$99.95

**44-0012** 12 " wide 870 CFM 12 V reversible

universal \$89.95

### Relay-electric fan control

**44-0016-R** This adjustable electric fan switch with thermostat allows you to run your electric fan in a much more efficient manner

universal \$42.95

### 44-0016-S

This Electric Fan Relay with Thermostat kit allows you to run your electric cooling fan in a much more efficient manner.

It powers up your electric fan when your motor reaches - 175-185 degrees F and powers down when your motor reaches 170 degrees F w/ temp sender 50-60 amp relay

universal \$74.95

### 44-0016-SD

Dual fan relay Kit, 80 Amps, 12V, temp sender, two 40 Amp relays, On at 195 degrees, Off 180 degrees, Harness, Kit

universal \$114.95

### Transmission Cooler

41-00TC-15 15 " dual pass external -aluminum

\$89.95

*Bill's Truck Shop*

Phone (905) 725-3460 / (905) 725-2022 / Fax (905) 404-2302 email: bill@billstruckshop.com



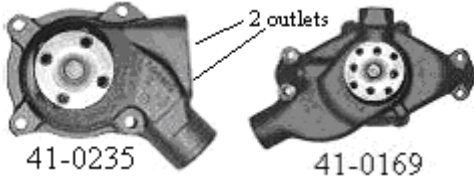

**Water Pump** \$15.00 core charge w/out old pump  
NEW or noted as rebuilt

41-0235	Chev	w/ dual outlet-includes 1 plug-NEW	55-62	\$169.95
41-0235-1R	Chev	-rebuilt 6 cyl OE style w/ single outlet	55-62	Inquire
41-0235-2R	GMC	w/3/8 groove pulley 6 cyl rebuilt	39-59	Inquire
41-0167	GMC	w/ 5/8 groove pulley 6 cyl	39-59	\$219.00
41-0167-R	GMC	w/ 5/8 groove pulley 6 cyl rebuilt	39-59	Inquire
41-0168	GMC	w/ 7/8 groove pulley 6 cyl	39-59	\$99.00
41-0169	Chev	v/8 w/ 5 5/8 length shaft 8 cyl	55-72	\$65.00

**Water Pump Pulley**

41-0380	235 6 cyl	55-62	\$10.00
---------	-----------	-------	---------

*Bill's Truck Shop*

Phone (905) 725-3460 / (905) 725-2022 / Fax (905) 404-2302 email: bill@billstruckshop.com

# Engine – Ignition

# Group 41



41-02SP-49



41-02PW-6

41-03PW-8



36-0704



36-0703

36-0705



36-0083



41-0168-12



41-0774



41-3PC



41-0PC



41-0D-235



41-0HE1

### Spark Plugs

41-02SP-49 6 cyl 49-62 \$5.95

### Spark Plug Wire Set w/ sealed plug caps

41-02PW-6 6 cyl 7 mm 47-62 \$42.95

41-03PW-8 small block V-8 w/ point ignition 55-72 \$59.95

### Spark Plug Wire Retainers-V8

36-0704 rear w/ small block 4 wire- L & R each 58-69 \$8.95

36-0795 secures on oil pan/2 wire-L & R side each 58-72 \$7.95

36-0703 secures @ heat shield on block 2 wire each 58-72 \$3.95

### Spark Plug Shields

36-0083 V8 set of 4 57-72 \$34.95

**Electronic Ignition**-Solid state electronic system fits entirely inside distributor. Easy to install. 12 volt 216, 235 and 261 cubic inch engines

41-0168-12 54-62 \$225.00

### Distributor

41-0D-235 235 CI engine/ plus \$30-00 core charge if core is not useable includes new cap, rotor, points, condenser

53-62 Inquire

### Ignition Points w/Condenser

41-03PC 6 cyl 47-62 \$49.95

41-3PC V8 55-56 \$21.95

41-0PC V8 57-74 \$19.95

HEI Distributor-6 cyl

41-0HE1 47-62

Grommet-Dist wire v8 only

41-0774 57-74 \$3.50

*Bill's Truck Shop*

Phone (905) 725-3460 / (905) 725-2022 / Fax (905) 404-2302 email: bill@billstruckshop.com



# Engine – Ignition

# Group 41



41-02DC-53

41-03DC



41-03DR-57



41-2IC-6



18-0203



41-02DR-53

41-3DC-55



41-03DR-55



### Dist Cap

41-02DC-53	6 cyl dist cap	53-62	\$45.95
41-3DC-55	V8 w/ side clips retainers	55-56	\$34.95
41-03DC	V8 w/ side screws	57-74	\$39.95

### Dist Rotor

41-02DR-53	6 cyl dist rotor	53-62	\$19.95
41-03DR-55	V8	55-56	\$7.95
41-03DR-57	V8	57-74	\$11.95

### Ignition Coil

41-2IC-6	6 volt	\$49.95
41-02IC-12	12 volt	\$39.95

### Ignition Resistor

18-0203	reduces 12v to 9v	\$16.95
---------	-------------------	---------

*Bill's Truck Shop*

Phone (905) 725-3460 / (905) 725-2022 / Fax (905) 404-2302 email: [bill@billstruckshop.com](mailto:bill@billstruckshop.com)

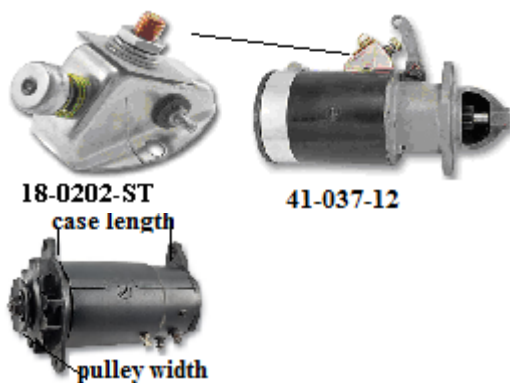

**CORE CHARGE apply to starter & gen \$25.00**

**Starter-----REBUILT**

41-037-6	6 cyl , 6 volt w/ ft start	starter	55-59	\$349.95
41-037-12	6- cyl 12 volt w/ ft start		55-59	\$349.95
41-037-12S	6 cyl 12 volt w/ key start		55-62	\$349.95
41-025-12S	V8 w/ key start solenoid—inquire w/ end housing style of application		57-62	\$349.95
41-027-12/6	6 cyl 12V starter converted to 6V for 55-62 235 engine		55-62	\$349.95



**Starter Solenoid**

41-0300	w/ ignition terminal	w/ key start	55-75	\$59.95
---------	----------------------	--------------	-------	---------

**Starter Brush set**

41-0059			41-62	\$14.95
---------	--	--	-------	---------



**Roof Light**

17-0033	metal housing w/ plastic amber lens 12 V bulb and mounting hdw included	each		\$39.95
17-0033-K	above lights w/ harness,switch & 5 lights (3" wide-8 ¾ long)			\$179.95

*Bill's Truck Shop*

Phone (905) 725-3460 / (905) 725-2022 / Fax (905) 404-2302 email: bill@billstruckshop.com

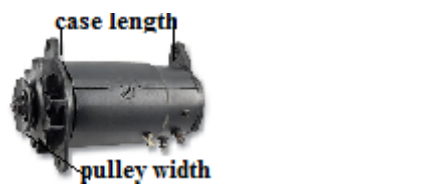

**CORE CHARGE** apply to starter & gen \$25.00  
**Generator-----confirm 3/8 OR 5/8 pulley and 6  
 “ or 7 “ case**

41-0G-6V	6 volt	<b>REBUILT</b>	47-63	\$295.00
41-0G-12V	12 volt	<b>REBUILT</b>	47-63	\$295.00

**Voltage Regulator-replacement ----neg ground**

18-210-6	6v w/ screw on terminals	40-55	\$122.95
18-0210-12-25	12 volt w/ 25 amp gen	47-62	\$69.95
18-0210-12-35	12 volt w/ 35 amp gen	47-62	\$69.95
18-0210-HK	OE style set of 3	47-62	\$1.20

**Generator Tag---not numbered**

41-000T	w 12 volt gen / includes rivets	55-62	\$8.95
---------	---------------------------------	-------	--------

**Alternator-1 wire activates on RPM-NO voltage regulator required**

19-0055	12 volt- 55 amp-	\$159.95
19-0033	female integral alt plug w/ terminals	\$7.95

**Alternator Brackets -lower 6cyl 235 cyl engine**

41-3AB	converts gen to alt -may require reshaping adjustment brace	55-62	\$89.95
--------	---	-------	---------

**Generator Bracket-adjust**

41-0240	283 & 327	55-62	\$44.95
---------	-----------	-------	---------

**Alt Belt**

41-0405	3/8 x 41 1/8	\$19.95
---------	--------------	---------



42-355M

**Shop Manual --Chev**  
Fully illustrated Includes data, specifications, wiring diagrams etc. to repair your truck. **Supplement** issue requires previous year manual

- 42-3SM-55
- 42-3SM-56 supplement to 1955
- 42-3SM-57
- 42-3SM-58
- 42-3SM-59 supplement to 1958

**Shop Manual -- GMC**

- 42-3SM-GMC

**Owners Manual** With GM plastic folder.

**Chevrolet**

- 42-355C
- 42-356C
- 42-357C
- 42-358C
- 42-359C

**GMC**

**inquire about others**

- 42-355G

**Accessory Installation Manual** Detailed illustrations of all accessories and explains how they are installed

- 42-355M
- 42-356M
- 42-357M
- 42-358M
- 42-359M

**Wiring Diagram**

- 42-3WD-55
- 42-3WD-56
- 42-3WD-57
- 42-3WD-58
- 42-3WD-59

Year      New      Used

55-55	\$36.95
55-56	\$15.75
57-57	\$36.95
58-58	\$44.95
59-59	\$19.95
55-59	\$29.95
55-55	\$22.95
56-56	\$22.95
57-57	\$22.95
58-58	\$22.95
59-59	\$22.95
55-56	\$17.95
55-55	\$14.95
55-56	\$14.95
57-57	\$14.95
58-58	\$14.95
59-59	\$14.95
55-55	\$9.95
56-56	\$9.95
57-57	\$9.95
58-58	\$9.95
59-59	\$9.95

## Bill's Truck Shop

Phone (905) 725-3460 / (905) 725-2022 / Fax (905) 404-2302 email: bill@billstruckshop.com

# Manuals & Brochures

Due to the fluctuation of the Canadian and American dollars call for current prices

# Group 42

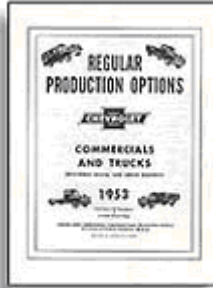
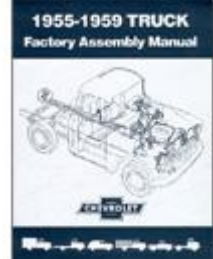

42-2RP053



42-2RP054



42-2TRG

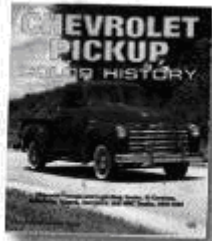

42-0CHB

**Factory Assembly Manual** Exploded views of the assembly of the trucks. Pertains to all years and GMC also.

42-3FAM

<u>Year</u>	<u>New</u>	<u>Used</u>
-------------	------------	-------------

55-59	\$44.95	
-------	---------	--

**RPO Booklet** Listing GM Regular Production Options for cars and trucks with prices and part codes.

42-3RP055

55-55	\$3.00	
-------	--------	--

**Chevrolet Pickup Colour History Book** History on Chevy pickups from 1918-1984 with photos.

42-0CHB

1918-84	\$27.50	
---------	---------	--

**Power Steering Repair Manual**

42-3PSM

55-59	\$6.00	
-------	--------	--

Check our website [www.billstruckshop.com](http://www.billstruckshop.com) for California trucks and parts

## Bill's Truck Shop

Phone (905) 725-3460 / (905) 725-2022 / Fax (905) 404-2302 email: [bill@billstruckshop.com](mailto:bill@billstruckshop.com)



# Accessories

Due to the fluctuation of the Canadian and American dollars call for current prices

# Group 44

		<u>Year</u>	<u>New</u>	<u>Used</u>
	<b>Exhaust Deflector</b> (each)			
44-0303	44-0303		\$23.95	
	<b>License Plate Frame</b> - chrome w/ blue details & year on top w/ CHEVROLET on bottom			each
44-2L54	NO GMC at this time			
	44-3L55	55-55	\$11.95	
44-028	44-3L56	56-56	\$11.95	
	44-3L57	57-57	\$11.95	
44-009	44-3L58	58-58	\$11.95	
44-006	44-3L59	59-59	\$11.95	
	<b>License Plate Fasteners</b>			
44-007	44-028 Chrome bullets set of 4		\$4.95	
	44-029 stainless steel carriage bolts w/ hdw set of 4		\$3.25	
44-0SE	44-030 4 nylon nuts w/ w screws		\$4.95	
	<b>Headlight Half Moon</b>			
44-0TV	44-009 Chrome 7 1/2" dia. pair		\$9.95	
44-0255-15	<b>Headlight Cat-Eye Cover</b> Chrome (pair)			
	44-006		\$14.95	
	<b>Headlight Visors</b>			
	44-007 stainless steel for 7 1/2 light pair		\$29.95	
	<b>Street rod Emblem</b>			
	44-0SE chrome-each		\$14.95	
	<b>Traffic Light Viewer</b> Repro of factory accessory.			
	44-0TV Used to assist in seeing the traffic light when truck had outside sunvisor		\$86.95	
	<b>Door Vent Shades</b> Original GM option			
	44-3151 stainless steel pair	47-59	\$64.95	
	<b>Rad Overflow Tank</b>			
	44-0255-15 15 " polished stainless steel	universal	\$84.95	
	44-0255-13 13 " polished stainless steel	universal	\$79.95	
	<b>Truck Covers</b> - we recommend <i>Hugger Covers</i> @ 905-857-1800 or <a href="http://www.huggercovers.com">www.huggercovers.com</a> --also a Canadian company-great product w/ great service			

## Bill's Truck Shop

Phone (905) 725-3460 / (905) 725-2022 / Fax (905) 404-2302 email: [bill@billstruckshop.com](mailto:bill@billstruckshop.com)



44-0PVC Accel pedal w/chrome vertical bars, rubber insert, spring loaded, adjustable arm & L or R mount universal \$89.95



44-0TBS-2 Throttle cable bkt w/ 350/400 kickdown adapt stainless steel universal \$29.95

44-0TBS Accel bkt a@carb w/ return springs stainless steel universal \$24.95

44-0TBS-1 Accel bkt bkt @ engine w/ return springs-stainless steel universal \$19.95

7-0007 Accel spring set universal \$9.95



**Adjustable Throttle Cables**

44-0TC-24 24" long/black coating universal \$29.95

44-0TC-24-SS 24" long/stainless steel universal \$44.95

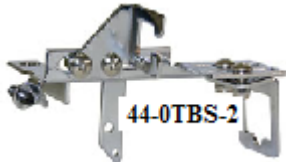

19-0412 \$129.95  
**Torque Converter Lockup Kit**, Pressure Switch, In-line Fuse, GM, 200-4R, 700R4, Kit

*Bill's Truck Shop*

Phone (905) 725-3460 / (905) 725-2022 / Fax (905) 404-2302 email: [bill@billstruckshop.com](mailto:bill@billstruckshop.com)



Custom Designed System is Easy to install, The Hurricane unit mounts to firewall using existing original heater mounting holes and includes new plastic glove box. Heater fittings will pass neatly through the firewall under the battery tray with a custom rubber grommet.

w/ electronic control

**Complete systems include:** Inside Package (Hurricane Unit, Wire harness w/ deluxe control, Louvers, Duct Hose, Expansion Valve, Mounting Bracket & hardware) Compressor, Compressor Bracket, A/C Hose Kit and Condenser Assembly.

50-55-9005 55-57 Inquire

50-58-9008 58-59 Inquire

**Complete, w/ Deluxe Electronic Control-** Includes a new electronic deluxe lever style heater control that fits into original dash opening. The electronic Hurricane Unit features High Torque electric servo motors to operate the Bypass Heater Valve and Defrost Functions

50-55-9100 55-57 Inquire

50-58-9105 58-59 Inquire

**Inside Package** - Hurricane Heat Cool & Defrost Unit, Deluxe Control, Wire Harness, Heater valves, Expansion Valve, Duct Hose, Louvers, Plastic Glove Box, Mounting Brackets and Necessary Hardware.

50-55-9100-IP w/ electronic control 55-59 Inquire

50-55-9000-IP w/ manual control 55-59 Inquire

**NOTES**

Comp upgrade for Chrome or Polished finish Compressor Bracket, (varies by engine application- water pump

Application info 1955-57 and 1958-59 Chev or GMC

<b>Vents</b>	<b>in dash</b>	<b>w/ 2 1/2 inlet</b>		
50-0125-R	louvered-round-chrome	each		\$19.95
50-0125-RT	louvered-rectangle-chrome	each		\$15.95

<b>Ducts</b>	<b>" Y " 2 1/2</b>			
50-0225-R	round w/ 2 1/2 outlets	each		\$13.95

<b>Hose</b>	<b>plastic 2 1/2</b>			
50-0325	6 ft			\$15.95

**AC TOOL**

We will lend the correct tool for crimping all the ac line fitting N/C

50-0125-R



50-0125-RT



50-0225-R



50-0325



*Bill's Truck Shop*

Phone (905) 725-3460 / (905) 725-2022 / Fax (905) 404-2302 email: bill@billstruckshop.com



**40-0175BCS**



**45-3559-DL**



**15-0301**

**41-0PSK-235**



**45-0PSCV**

**Column Saver kit** allows reusing the original column w/ Mustang II front ends or any other replacement steering box—installs housing w/ bearing in original column—complete w/ instructions

40-0175BCS	47-59 GM trucks & cars w/ 1 ¾ column	47-66	\$144.95
40-0150BCS	GM trucks & cars w/ 1 ½ column	48-64	\$89.95

**Power Steering Custom Drag Link**

45-3559-DL	custom drag link for 400 series power steering box—adjustable (helps correct steering return on turns)	55-59	\$114.95
------------	--	-------	----------

**Power Steering Pump Bkt kit-** fits small block Chev w/ long or short neck water pump—will require additional crank pulley

15-0301			\$94.95
---------	--	--	---------

**GM power steering pump bracket kit**—fit early 216 & 235 engine 1947-1962—pump not included

41-0PSK-235		50-62	\$299.95
-------------	--	-------	----------

**These brackets require the use of an alternator and will not work with a factory generator. Complete bolt on assembly—requires a double pulley on power steering pump**

**Power Rack Control Valve w/ adapt fitting**

45-0PSCV	when using early power steering pumps on mustang steering rack		\$24.95
----------	--	--	---------

*Bill's Truck Shop*

Phone (905) 725-3460 / (905) 725-2022 / Fax (905) 404-2302 email:

*bill@billstruckshop.com*

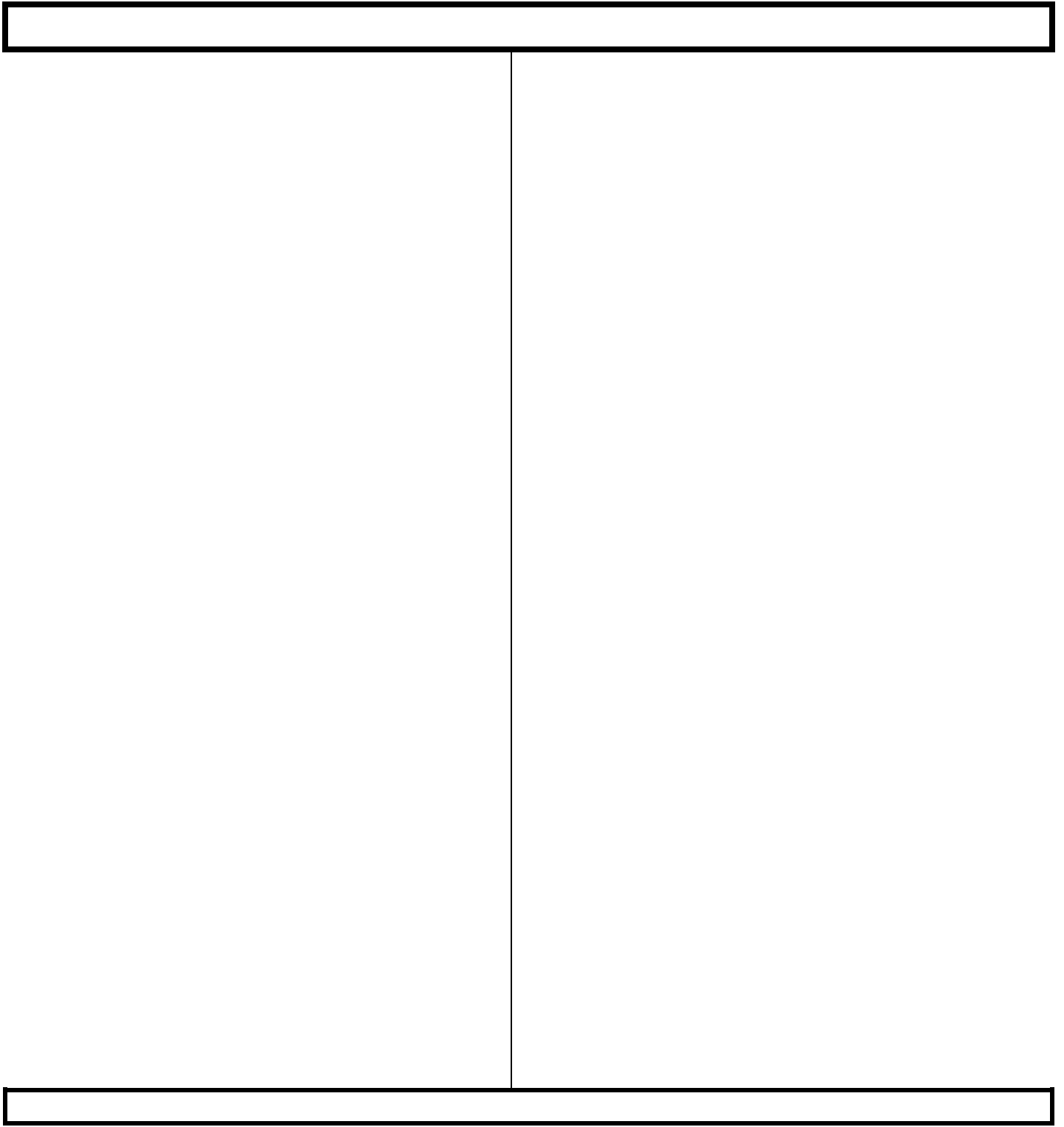



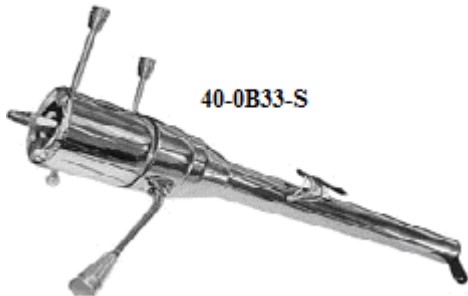
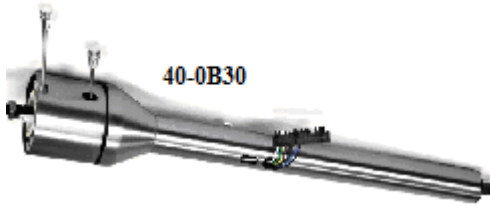

**Tilt Columns-w/ new style GM signal switch w/ flat 3 7/8 flat plug NO P/N-rev switch**

**UNIVERSAL APPLICATION**

**Includes shift levers & indicator w/ shift-use your OE support -add support bushing # 5-0316 & lower column seal #7-308-4**

40-0B33-S	Tilt Column-33"/black -aut-1" DD shaft	\$699.95
40-0B32	Tilt column-32"/black-no shift/1"DD shaft	\$699.95
40-0B32-S	Tilt Column-32"/black -aut-1" DD shaft	\$699.95
40-0B30	Tilt Column-30"/black-no shift/1"DD shaft	\$699.95
40-0B30-S	Tilt Column-30"/black -aut-1" DD shaft	\$699.95
40-0B33-S	Tilt column-33" /black w/ aut 1" DD shaft	\$699.95

**IDIDIT STEERING COLUMNS US MADE**

1955-59 Chevy Truck column comes with it's own specially designed under dash mount and floor mount with gasket, 1" DD output shaft .columns are available in steel ( S)-chrome-(C)-brushed (BA) or polished aluminum-(PA)-black powder coated-(PB)  
8 position tilt, cancelling turn signals,4 way flasher, retro style levers, neutral safety switch-3 7/8 flat signal harness plug, 1" DD output shaft

40-3140-TAS	tilt, aut, paintable steel	Inquire
40-3140-TS	tilt, no shift, paintable steel	Inquire

**Shift Indicator**-required on all columns  
acrylic-stick on

3-0010-3	w/3 speed auto	\$44.95
3-0010-4	w/4 speed auto	\$44.95

40-0804	<b>Transmission shift kit –GM 2 “ column mount/ 6’ cable w/all bkts &amp; hdw</b>	\$249.95
	TH350, TH400, 700-R4, TH200, 200-R4, 4L60 and 4L80E	



**Steering Shaft –u-joint** when joining new columns to new steering systems (eg 3/4-30 spline to double D shaft)  
 CNC machined Billet Steel- **always drill a dimple in shaft where set screw seats**

41-0UJ1	9/16-26 x 3/4-DD ( mustang manual rack)	\$109.95
41-0UJ3	3/4-30 x3/4-DD	\$109.95
41-0UJ4	3/4 -36 x 3/4 - 36	\$109.95
41-0UJ5	3/4-36 x 3/4-DD (mustang power rack)	\$109.95
41-0UJ6	3/4-DDx3/4-DD	\$109.95
41-0UJ7	1-DDx3/4-DD	\$109.95
41-0UJ9	13/16-36 x3/4-DD	\$109.95
41-0UJ16	3/4-DD x 3/4 smooth	\$109.95
41-0UJ17	3/4 DD x 17MM	\$109.95
41-0UJ18	3/4- 36 x 1-DD	\$109.95
41-0UJ24	3/4-30 x 1-DD	\$109.95
41-00SS	3/4 steering shaft support	\$39.95

**Double Steering u-joint**

41-0DUJ6	3/4DD x 3/4DD	\$204.95
41-0DUJ32	3/4-36 x 3/4 -DD	\$204.95

**Steering Rag Joint**

41-0RJ30	1”DD x 3/4 -30 spline	\$134.95
41-0RJ36	3/4 -36 x 11/16 -36	\$134.95
41-0RJ36-3/4DD	3/4”DD x 11/16 -36 spline	\$134.95
41-0RJ366-3/4DD	3/4 DD x 3/4-36 spline	\$134.95
41-0RJ36-1DD	1”DD x 3/4 -36 spline	\$134.95
41-0RJ366-1DD	1DD x 11/16 -36 spline	\$134.95
41-0RJ10	1”DD x 3/4” DD	\$134.95

**Steering Rag Joint (mini 2 7/8 OD)**

41-0RJ24-M	1”DD x 3/4 30 spline	\$114.95
41-0605S	3/4 DD x 3/4 30 spline x 3/4 round- includes drift pin-----w/ using cut OE column	\$114.95

**Steering Shaft Coupler**

41-0SC36	3/4 DD x 3/4 x 36	\$75.00
----------	-------------------	---------

# PERFORMANCE ACCESSORIES

# Group 40

40-1850-DD



40-00SF



40-00SR



40-0626-AD

41-0UJ18

41-0UJ3

40-0CS-2x2.5



40-0LCS



40-0LCS-2

40-0LCS-4



**Column Saver kit** allows reusing the original column w/ Mustang II front ends or any other replacement steering box- installs housing w/ bearing in original column-complete w/ instructions

40-0175BCS	47-66 GM trucks & cars w/ 1 3/4" column	47-59*	\$72.50
40-0150BCS	47-66 GM trucks & cars w/ 1 1/2" column	47-59	\$72.50
40-0150BCS-A	47-59 GM trucks & cars w/ 1 1/2" column w/ 3/4" x 3/4" DD U-joint & stub shaft	47-59	\$134.95

40-1850-DD	BLACK- steel 18"	\$54.95
40-1850-DDN	nickel plated 18"	\$46.95

40-3650-DD	unplated steel 36"	\$69.95
40-3650-DD-BO	black oxide 36"	\$78.95

40-1870-3/4N	nickel plated 3/4" round x 36 spline 24" long	\$69.95
--------------	---	---------

### Collapsible Steering Shaft

40-0626-AD	1" DD to 3/4" DD" Adjustable steering shaft 16" to 26" nickel plated	\$119.95
40-0636-AD	1" DD to 3/4" DD" Adjustable steering shaft 24" to 35" nickel plated	\$129.95

### Intermediate Shaft & Flange

40-00SF	9 1/4" w/ rag joint flange -accepts 3/4" shaft w/ dust boot-operates as a collapsible safety shaft	\$39.95
40-00SR	4" long 3/4" round input end w/rag joint flange end-drill & pin to column shaft (recommend welding tube to shaft)	\$34.95

### Upper Column Support

40-0CS-2x2.5	polished aluminum 2" shaft	47-59	\$79.95
--------------	----------------------------	-------	---------

### Lower Column Support w/ boot @ floor

40-0LCS-2		\$149.95
40-0LCS	swivel polished aluminum w/o boot	\$104.95
40-0LCS-4	adjustable swivel 2" shaft	\$63.95

*Bill's Truck Shop*

Phone (905) 725-3460 / (905) 725-2022 / Fax (905) 404-2302 email: bill@billstruckshop.com

# PERFORMANCE ACCESSORIES

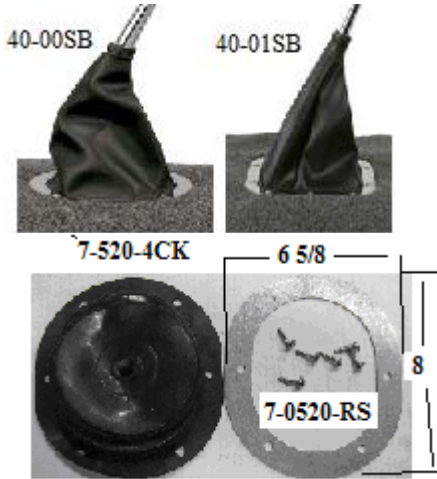

## Replacement Shifter Boot w/ 4 and 5 speed std transmission

40-00SB	round shift booth w/ stainless ring 5"round	\$53.95
40-01SB	rectangular shift boot w/ stainless ring 7 long x 5 wide	NLA
7-520-4CK	4 Speed Shift Boot	\$28.95
7-0520-RSS	Retainer-20 G brushed stainless steel w hdw	\$22.95



## Torque Converter Lockup Kit, Pressure Switch, In-line Fuse, GM, 200-4R, 700R4, Kit

19-0412		\$91.95
---------	--	---------



## Power Steering Pulley

15-0508	Double pulley/nut on-replaces GM 3941107	\$59.95
15-0810	single groove-press on-back spaced-replaces GM 3834720	\$59.95

## Alt bkt kit

50-002L-DS	drivers side mount / small block Chev w/ long neck water pump-top mount	\$136.40
50-002S-DS	drivers side mount / small block Chev w/ short neck water pump-top mount	\$136.40

## Water Pump Pulley

50-0155	5.5" in w/6" outer double pulley @ water pump 2 1/4 hole spacing replaces GM # 14023155	\$129.95
50-0142	6" double pulley -w/ short neck water pump w/ 1 3/4 hole spacing replaces GM # 3995642	\$94.95
50-0142-C		

*Bill's Truck Shop*

Phone (905) 725-3460 / (905) 725-2022 / Fax (905) 404-2302 email: bill@billstruckshop.com

# BRAKES



17-0VP-1      17-0VP-2      17-0VP-3

PRE-5564



PRE-9



PRE104-3824

36-0PCH



17-0BV-B



45-0213



## Intake Vacuum Port

17-0VP-1 1 port hose fitting - 3/8" intake hole- for power brakes \$29.95

Intake Vacuum Port 2 port T fitting - 3/8" intake hole- for power brakes & 1/4" auto trans modulator line \$29.95

17-0VP-3 3 Intake Vacuum Port 3 port fitting - 3/8" intake hole- for power brakes-auto trans & AC Inquire

## Brake Booster & PCV Hose

36-0PCH 3/8 x 35" w/ clamps \$24.95

## Brake Booster Check Valve

17-0BV-B black \$15.95

## Universal brake booster

45-0DD8 8" dual diaphragm zinc plated \$189.95

## Pedal support/Pad

45-0213 \$29.95

## Bill's Truck Shop

Phone (905) 725-3460 / (905) 725-2022 / Fax (905) 404-2302 email: bill@billstruckshop.com

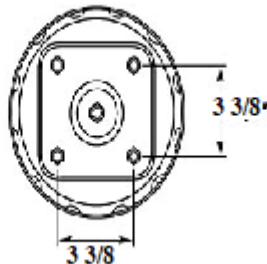
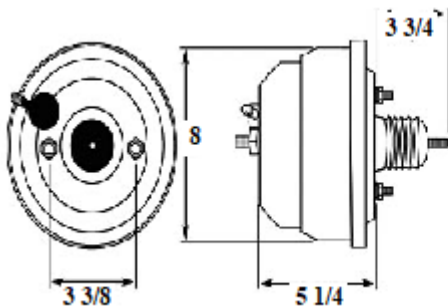



# BRAKES



## Proportioning Valves

17-0PVKS-2	Brake Proportioning Valve -disc/drum w/ lines-when converting to disc- ft-drum rear	<b>BRASS</b>	\$149.95
17-0PVKS-4	Brake Proportioning Valve -disc/drum w/ lines-when converting to disc-disc	<b>BRASS</b>	\$149.95
17-0PVKS-A4	Brake Proportioning Valve - disc/drum & or disc/drum w/ lines & bracket	<b>ALUMINUM</b>	\$159.95

## Harness-proportioning valve switch

17-0PVK-H	replacement harness w/ socket	\$19.95
-----------	-------------------------------	---------

## Disc Brake kit

45-0WBK-5	47-59-5 <b>lug disc brake kit</b> —uses stock ½ spindles & hubs Kit includes rotors, callipers, brackets, flex hoses and hardware Bearing upgrade(tapered roller w/ seals) may not work with stock wheels	47-59	\$659.95
-----------	---	-------	----------

45-0WBK-6	47-59-6 <b>lug disc brake kit</b> —uses stock ½ spindles & hubs/ kit -includes rotors, callipers, brackets, flex hoses and hardware-Bearing upgrade(tapered roller w/ seals) is recommended-calipers may not work with stock wheels	47-59	\$799.95
-----------	---	-------	----------

38-04759-BK	<b>Wheel Bearings kit</b> -upgrades to tapered roller bearings w/ grease seals ½ ton only	47-59	\$199.95
-------------	---	-------	----------

38-04759-S	<b>Grease seal</b> -replacement for bearing kit	each 47-59	\$13.95
------------	---	------------	---------

45-0DBK-5	47-59 <b>Disc brake upgrade bkt kit</b>	47-59	\$174.95
-----------	---	-------	----------

5 x 4 ¾ bolt pattern-add callipers, 11", rotors w/ bearing upgrade kit, brackets, flex hoses and hardware-bolts to stock spindles. Converts your straight axle to disc brakes-used factory holes on ½ ton spindle-kit includes calliper brackets, bearing adaptors & hdw-used 70-77 Camaro rotors & callipers- -will also have to upgrade to dual master & prop valve

17-0BR13	Inner wheel bearing	each	\$16.95
17-0BR2	Outer wheel bearing	each	\$14.95
17-0984	grease seal	each	\$5.95

## Bill's Truck Shop

Phone (905) 725-3460 / (905) 725-2022 / Fax (905) 404-2302 email:

bill@billstruckshop.com

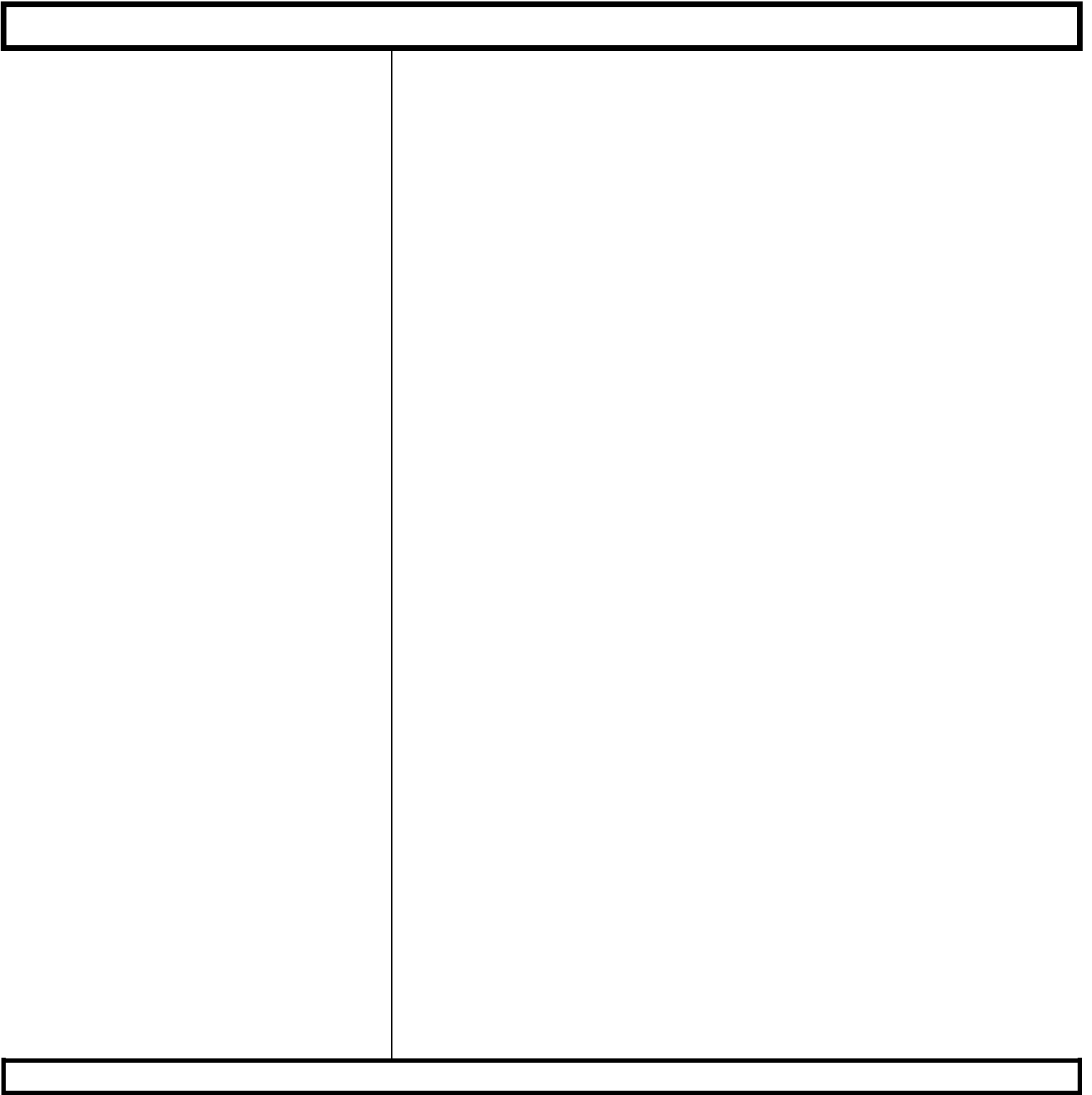



55-59 **Mona leaf springs**-exceeds multi leaf specifications  $\frac{3}{4}$ " thick-  
improves handling and ride w/ lower ride height-fit original shackles-  
include bushing and u-bolts- gives 3' drop front and 4" drop rear

45-3CTFR	front/pair 3"	\$535.00
45-3CTRS	rear/pair 4"	\$535.00



55-59 Firewall mount brake booster kit-bolts to firewall(remove original column support) includes mount bracket, pedal w/ linkage, 8 "booster, master cylinder 1" bore, & prop valve -Add # 45-0134 mechanical brake light switch

45-3559-FB4-8 disc-disc & disc drum \$649.95

45-3559-FB bracket w/ pedal only \$245.00

55-59 Frame **mount brake booster**-bolts in the stock location using original pedals-includes 8" dual diaphragm booster, 1 " bore master cylinder, proportioning valve, mount bracket w/ hardware & prop valve - brake lines will need modifying

45-3BBD-8D drum-drum application -no prop valve \$589.95

45-3BBD-8DD disc-disc & disc drum application \$624.95



45-3BBD-SDD

45-3BB-7-P disc- drum w/ prop valve, 1" master, 7" dual diaphragm & pedal assembly w/ hdw \$495.95



45-3BB-7-P



55-59 Rear say bar kit (w/ stock suspension)-helps reduce roll and increase steering stability-complete w/ 7/ 8 bar, poly bushing, brackets and hardware will mount on stock and flip applications w/ rear axle tube to 3" dia

40-3RSB \$299.95



45-3559-FSK

55-59- Front sway bar-(w/ stock suspension) original style-helps improve driveability by reducing roll and lane darting-kit complete w/ hardware and instructions 1" bar-w/ original I-Beam



45-3559-FSK-P

55-59- Front sway bar-(w/ stock suspension) helps improve driveability by reducing roll and lane darting-kit complete w/ hardware and instructions 1" bar-performance upgrade w/ V8 engine @ original I-Beam

45-3559-FSK-P \$279.95



Power steering pitman arm when converting to power steering box

45-0759PA-PS standard height \$79.75

45-0759PA-PR reversed for lowered trucks \$74.75

# HARDWARE

49-0610	5/16-18 x 7/8 w/11/16 floating washer-NC	each	\$1.65
49-0612	5/16-18 x 1 w/7/8 floating washer-NC	each	\$2.10
49-0613	5/16 -18 x 3/4 w/ washer head -NC	each	\$1.65
49-0614	3/8-16 x 1 w/ 1 floating washer-NC	each	\$2.95
49-0615	3/8 -16 x1 1/2 w/ 1 1/8 floating washer NC	each	\$3.25
49-0710	5/16 – 18 U – nut	each	\$1.50
49-0620	5/16 -18 x 3/4 w/ OE style washer head NC	each	\$0.95
49-0621	5/16 -18 x1 1/16 dog point w/ floating washer-each		\$1.75
49-0622	5/16 -18 x 15/16 dog point w/ floating washer-each		\$1.95

## BODY ALIGNMENT SHIM-galvanized steel

20-000D	1/16 w/ 3/8 slot shim	each	\$1.25
20-000E	1/8 w/ 3/8 slot shim	each	\$1.25
20-000K	8 pc Shim kit 4 x 1/16 and 4 x 1/8	set of 8	\$9.95

## Totally Stainless bolt kits

Every Body Kit includes component kits-for Front Bumper, Door Hinges, Door Latch & Catch, Fender to Firewall Brace Rods, Front & Inner Fenders, Grill & Gravel Pan, Headlight & Parking Lens, Hood Hinges, Hood Latch, Catch & Braces, Interior, Outside Mirror, Radiator Support, and Regulator & Relay.

49-3324	55-55 Chev -Body Bolt kit- 18-8 stainless steel w/ indented hex bolts-OE style /cab forward does not include bed any bed hdw		\$369.95
49-3238	56-57 Chev -Body Bolt kit- 18-8 stainless steel w/ indented hex & Philips head bolts & -OE style /cab forward does not include bed any bed hdw		\$369.95
49-3294	58-59 Chev -Body Bolt kit- 18-8 stainless steel w/ indented hex bolts-OE style /cab forward does not include bed any bed hdw		\$369.95



*Bill's Truck Shop*

Phone (905) 725-3460 / Fax (905) 725-2022 / email: bill@billtruckshop.com





## Chevrolet Chassis Identification

Years	Series & Model	Class	Wheelbase	Bed Type
1955 2nd Series	3100 3104	1/2 Ton	114"	Stepside
	3124	1/2 Ton	114"	Fleetside
	3200 3204	1/2 Ton	123-1/4"	Stepside
	3600 3604	3/4 Ton	123-1/4"	Stepside
1956-1957	3100 3104	1/2 Ton	114"	Stepside
	3124	1/2 Ton	114"	Fleetside
	3200 3204	1/2 Ton	123-1/4"	Stepside
	3600 3604	3/4 Ton	123-1/4"	Stepside
1958	3100 3104	1/2 Ton	114"	Stepside
	3124	1/2 Ton	114"	Fleetside
	3134	1/2 Ton	114"	Fleetside
	3154	1/2 Ton	114"	Stepside
	3200 3204	1/2 Ton	123-1/4"	Stepside
	3234	1/2 Ton	123-1/4"	Fleetside
	3600 3604	3/4 Ton	123-1/4"	Stepside
	3634	3/4 Ton	123-1/4"	Fleetside
	3654	3/4 Ton	123-1/4"	Stepside
	3684	3/4 Ton	123-1/4"	Fleetside
1959	3100 3104	1/2 Ton	114"	Stepside
	3134	1/2 Ton	114"	Fleetside
	3154	1/2 Ton	114"	Stepside
	3200 3204	1/2 Ton	123-1/4"	Stepside
	3234	1/2 Ton	123-1/4"	Fleetside
	3600 3604	3/4 Ton	123-1/4"	Stepside
	3634	3/4 Ton	123-1/4"	Fleetside
	3654	3/4 Ton	123-1/4"	Stepside
	3684	3/4 Ton	123-1/4"	Fleetside

## 1955-59 Chevrolet Serial Identification Number

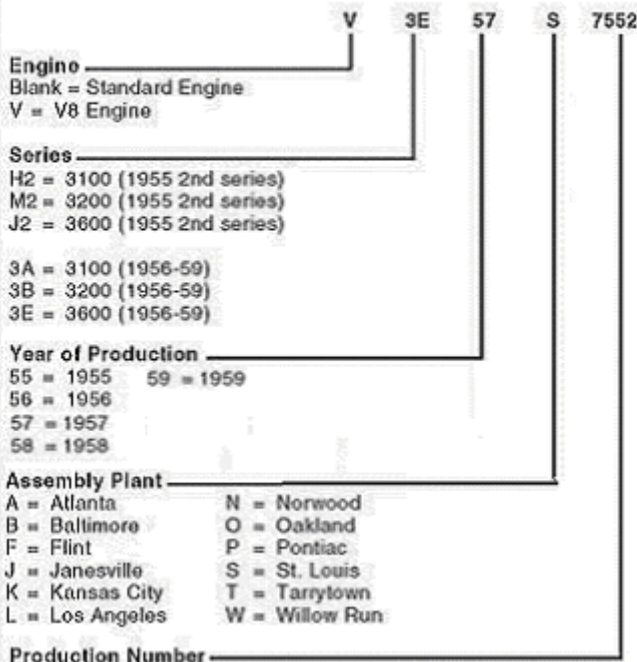

## 1955-59 2nd Series GMC Serial Identification Number

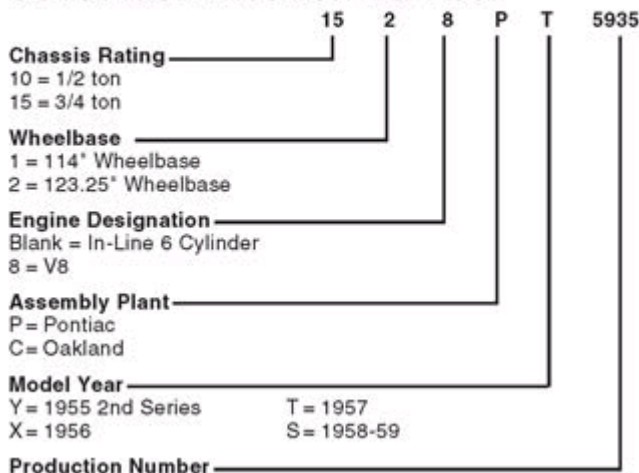

## GMC Chassis Identification

Years	Series & Model	Class	Wheelbase	Bed Type
1955-56 2nd Series	100 1766	1/2 Ton	114"	Stepside
	100 1768	1/2 Ton	114"	Suburban Pickup
	100 150 1767	1/2 & 3/4 Ton	123-1/4"	Stepside
1957	100 1766	1/2 Ton	114"	Stepside
	100 1768	1/2 Ton	114"	Suburban Pickup
	100 150 1767	1/2 & 3/4 Ton	123-1/4"	Stepside
	100 150 1799	1/2 & 3/4 Ton	123-1/4"	Stepside
1958	100 1766	1/2 Ton	114"	Stepside
	100 1768	1/2 Ton	114"	Suburban Pickup
	100 1802	1/2 Ton	114"	Fleetside
	100 150 1799	1/2 & 3/4 Ton	123-1/4"	Stepside
	100 150 1804	1/2 & 3/4 Ton	123-1/4"	Fleetside
1959	100 1766	1/2 Ton	114"	Stepside
	100 1802	1/2 Ton	114"	Fleetside
	100 150 1799	1/2 & 3/4 Ton	123-1/4"	Stepside
	100 150 1804	1/2 & 3/4 Ton	123-1/4"	Fleetside

## Chevrolet Engine Identification

### 1947-59 3100, 3200, 3600

Years	Series & Model	Class	Wheelbase	Bed Type
1955 2nd Series	3100 3200 3600	235	6 Cylinder	I-6
	3600	265	8 Cylinder	V-8
1956-1957	3100 3200 3600	235	6 Cylinder	I-6
	3100 3200 3600	265	8 Cylinder	V-8
1958-59	3100 3200 3600	235	6 Cylinder	I-6
	3100 3200 3600	283	8 Cylinder	V-8

When you build a chassis and position the driveline components, you need to orient them so that the angle of a line drawn through the center of the transmission exiting through the output shaft (A) and a line drawn through the center of the driveshaft (B) is equal to but opposite the angle of a line drawn through the pinion shaft in the rear differential (C) and the line drawn through the center of the driveshaft (B). The accompanying drawing illustrates how the lines drawn through the transmission and pinion shafts (A&C) are parallel to each other, though not in the same plane.

Next step is to measure the rear end pinion shaft angle. It should be pointing upward towards the front with the vehicle sitting at ride height on a level surface. At least 1-degree and ideally not more than 3-degrees up. You can alter the rear end pinion shaft angle by inserting or removing wedge shaped shims under the rear spring mounts or by adjusting the length of the control arms positioning the rear end.

