

GENERAL INFORMATION

Ordering Information: Please make sure you are ordering the correct parts. Verify part numbers upon ordering. On larger orders please fax (905) 404-2302, email at bill@billstruckshop.com / rob@billstruckshop.com / aaron@billstruckshop.com or call for more information.

Payment: We accept VISA, MasterCard, Money Orders, E-Transfers, Personal and Company cheques. Payment plans also available on large restoration. Applicable taxes apply to all sales.

Shipping: Ship by your choice of Canpar, UPS, FedEx, Canada Post, or truck carrier on some large items. Most orders can be shipped same day for next business day delivery. Actual shipping charges will be applied. Also, a \$10.00 COD surcharge applies.

Pricing: Prices are in Canadian currency. Due to constant fluctuation between the Canadian and U.S. dollar –refer to the prices in the catalogues as a **GUIDE ONLY!** Bill's Truck Shop Limited Ltd., reserves the right to make appropriate changes as necessary. We try to keep prices low by keeping a large inventory on hand at all times. WE never buy parts with YOUR money to sell to YOU so we never pre-charge you for normal stocking items that are out of stock.

Returns and Guarantees: If fault is found in the parts or workmanship of item purchased, full money back guarantee or exchange for new item. If fault occurs from installation or misuse, no return will be given. No refunds will be given on electrical components or literature. Call with any questions.

Back Orders: No shipping charges will be applied to regular stocked items, unless a manufacturer's back order applies. All back orders cancelled after 60 days.

Discounts: Business's may apply for discounts after providing valid business info. Regular customer discounts can be applied depending on volume purchases / monthly specials and payment type. (E.g.: 3% discount on cash sales - on applicable items only) Check our website for monthly specials.

Parts: There is an ever increasing supply of reproduction parts, they are not always listed in the catalogues. New items can be viewed on our website, www.billstruckshop.com or call for info.

Used Parts: Unlike many other parts suppliers we stock or locate many parts that are not reproduced. We import parts from (California) and bring back trucks, beds, cabs etc. Bill's Truck Shop Limited has made a commitment to supply many new and used parts for your restoration and as a result we are the largest truck part supplier in Canada. NO discounts on used parts. We also will take your used parts in on trade.

Hours of Operation:

Monday to Friday 8:00am to 5:00pm EST

Saturday 9:00am to 3:00pm – Confirm by appointment

Sunday and holidays –Closed

NOTE: IF DRIVING LONG DISTANCE TO VIEW OUR INVENTORY, PLEASE CALL AHEAD!

Cab & Door Weatherstrip

Due to the fluctuation of the Canadian and American dollars call for current prices

Group 1

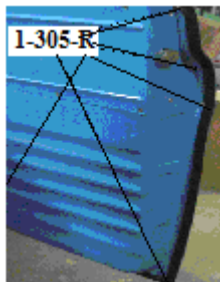
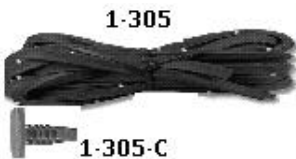
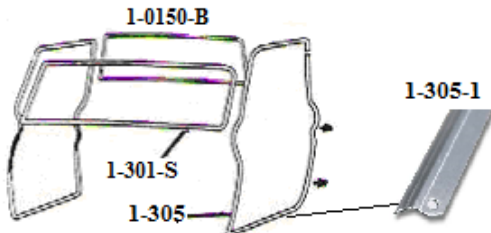

Windshield Weatherstrip

		Year	New	Used
1-301-S	standard-does not accept trim	55-59	\$74.95	
1-301-D	deluxe - accepts trim	55-59	\$79.95	

Rear Glass Weatherstrip

1-0150-B	w/ black lock strip	47-66	\$49.95	
1-0150-C	w/ chrome lock strip	47-66	\$59.95	
1-05561-BB	big window w/ black lock	55-66	\$89.95	
1-05561-BC	big window w/ chrome lock strip	55-66	\$89.95	

Chrome Lock Strip per ft 7/16 W x 7/32W

1-0500	replacement-sold per ft	47-66	\$3.00	
--------	-------------------------	-------	--------	--

Door Rubber Seals (pair)

1-305	w/ nylon clips, square corners-may require to relocate pin holes in door or seal	55-59	\$69.95	
1-305-P	panel/suburban rear doors -OE moulded corners w/ steel retainers & nylon clips	55-59	\$269.95	
1-0205-R	universal rear door seals-glue on-pair	36-66	\$35.00	

Door Seal Retainers-# of retainers clips vary from 55-59 & Canadian / US and series size trucks-some also had another @ door front @ rear

1-305-R	metal clips at curve next to handle @ both lower corners 5 w/ screws/per door	55-59	\$10.95	
1-305-C	nylon clips set of 10	55-59	\$5.25	

Lower Door Seal Retainer (each)

1-305-1	steel	55-59	\$14.95	
1-305-1SS	stainless steel	55-59	\$22.95	

Retainer Screw Kit (16) -2drs

1-305-SK		55-59	\$4.95	
----------	--	-------	--------	--

Bill's Truck Shop

Phone (905) 725-3460 / (905) 725-2022 / Fax (905) 404-2302 email: bill@billstruckshop.com

Used

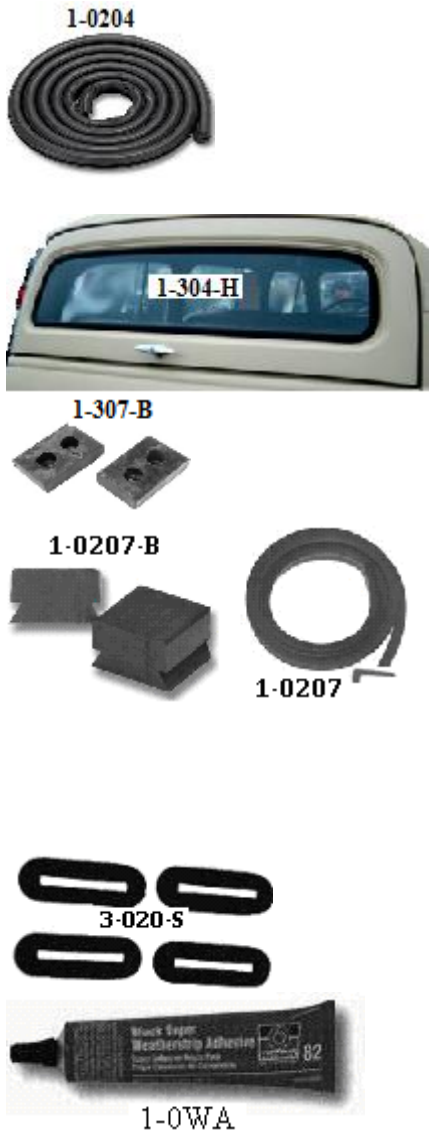

Panel & Suburban Rear Glass Weather-strip

1-0204	seal for rear glass in doors and upper hatch - universal type----- cut ½ for rear door glass	47-59	\$59.95
1-0204-OE	vulcanized 1 pc OE style for rear barn door glass ----- each	47-59	\$56.95
1-304-H	in upper hatch w/ clam shell doors-correct OE 1 pc design w/o lock strip	55-59	\$99.00

Suburban Sliding Window Weatherstrip Kit

	seals/channels & weather-stripping (per window)		
11-0411-SL		55-66	\$49.00

Suburban Stationary Window Weatherstrip Kit

11-0411-ST	per window	55-66	\$29.95
------------	------------	-------	---------

Rear Door Link Arm Bumper-Panel/Suburban

1-0207-B	rear barn door upper check arm bumper-USA made	pair	47-59	Inquire
----------	--	------	-------	---------

Rear Door Bumper-Panel/Suburban

1-307-B	rubber wedge bumper located on top & bottom of drivers rear door -screwed into place	pair	55-59	Inquire
---------	--	------	-------	---------

Rear Valance Seal-panel & suburban

1-0207		47-59	\$26.95
--------	--	-------	---------

Door Hinge Seals

3-020-S	panel/suburban w/ barn doors-set of 4	36-59	\$36.95
---------	---------------------------------------	-------	---------

Weather strip Adhesive-black

1-0WA			\$16.95
-------	--	--	---------

Bill's Truck Shop

Phone (905) 725-3460 / (905) 725-2022 / Fax (905) 404-2302 email: bill@billstruckshop.com

Cab & Door Weatherstrip

Due to the fluctuation of the Canadian and American dollars call for current prices

Group 2

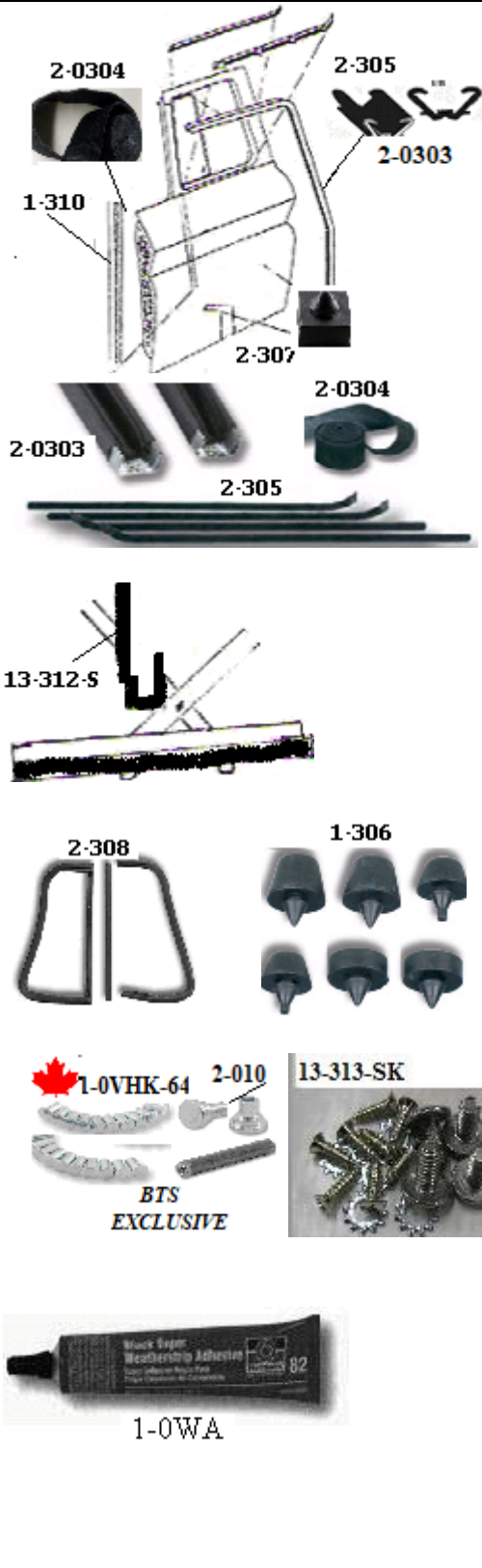

			<u>Year</u>	<u>New</u>	<u>Used</u>
Division Bar Post - with liner /stainless beading					
12-0984	w/framed door glass	each	55-63	\$44.95	
Door Glass Sash Seal					
13-312-S	& secures glass into sash	each	55-59	\$8.95	
Door Glass Channel Runs					
2-0303	felt lined track for framed glass	pair	55-63	\$119.95	
2-0303-1	single lined track		55-63	\$59.95	
Installing one pc glass w/ metal frame					
11-405-1	60-63 Door Glass Channel Run w/ out metal frame on glass	use 1 pr per door	60-63	\$83.95	
Division Bar Relining Channels					
2-0304	felt liner w/glued back	pair	55-63	\$26.95	
Door Window Seals/Scrapers With Clips					
2-305	w/ black beading	set of 4	55-59	\$99.95	
2-305-S	w/ stainless beading	set of 4	55-59	\$99.95	
2-306K-A	used when installing 1 pc glass-w/o vent windows & w/stainless beading	set of 4	55-59	\$109.95	
Door Felt Kit					
2-306K	includes 0303/0304/305	for 2 doors	55-59	\$229.95	
Window Stop Bumper					
2-307		pair	55-59	\$3.95	
Vent Window Rubber kit					
2-308	original design	pair	55-59	\$79.95	
Vent Window rubber install kit-includes rivets//tool					
1-0VHK-55			55-63	\$14.95	
2-010	a pair of vent window pivot rivets			\$6.25	
Glass Setting Tape –rubber- for door and vent glass					
1-0GST	0.062 thick	per foot		\$2.00	
1-0GST-1	thinner 0.047 thick	per foot		\$2.00	
Vent Window Ass install kit-2 doors					
13-313-SK	stainless steel		55-59	\$6.95	
Door Bumper Set					
1-306	2 doors		55-59	\$6.50	
Weather strip Adhesive-black					
1-0WA				\$15.95	

Bill's Truck Shop

Phone (905) 725-3460 / (905) 725-2022 / Fax (905) 404-2302 email: bill@billstruckshop.com

Hood – Fender

Due to the fluctuation of the Canadian and American dollars call for current prices

Group 3



			<u>Year</u>	<u>New</u>	<u>Used</u>
Hood to Cowl Seal	with retaining clips				
3-303			55-59	\$18.95	
Hood Bumper Set					
3-303-55	10pcs		55-57	\$9.95	
3-303-58	8 pcs		58-59	\$9.95	
Hood Adjuster Bolt	Chev-@rear of hood on cowl & GMC @ rear on cowl & front on hood latch support				
3-320-HA	original used	each	55-59		\$5.00
3-320-HS-S	stainless steel w/ washer ,set nut & bumpers	pr	55-59	\$13.95	
3-320-B	rubber cap for hood adjuster bolt	pair	55-59		
Inner Fender Mounting Grommets	/ inner fender @ cab & rad support				
3-304-G	4 pieces w/ steel sleeves		55-59	\$12.95	
3-304-BK	correct recessed head bolts w/ locked on washers; sleeves & grommets	set of 4	55-59	\$26.95	
Inner Fender Support	@ firewall				
34-355-S	left or right	each	55-59	\$13.95	
34-355-S-SS	stainless steel w/ hdw	pr	55-59	\$28.95	
Braces-Front Fender to Cab					
3-31F		steel/pair	55-59	\$44.95	
3-31F-SS		stainless steel/pair	55-59	\$52.65	
Inner Fender Seal Kit	/U-shaped seal for rear of inner fender at firewall for both sides-included w/ 3-305				
3-304		NEW PRICE!!	55-59	\$11.75	
Outer-Inner Fender Gasket set					
3-305	does both sides-includes 3-304 / 3-306		55-59	\$24.95	
Outer Fender to Cab Seals	included w/ #3-305				
3-306	glue to rear vertical of fender	pair	55-59	\$8.95	
Fender Align Grommets					
3-316	hole used to align inner to outer fender	pair	55-59	\$3.25	

Bill's Truck Shop

Phone (905) 725-3460 / (905) 725-2022 / Fax (905) 404-2302 email: bill@billstruckshop.com

Hood – Fender

Due to the fluctuation of the Canadian and American dollars call for current prices

Group 3

55-57 hood hinge bolt spacing on firewall is 3 1/8 and 58-59 is 3 5/8 outside dia –top hole is in same location

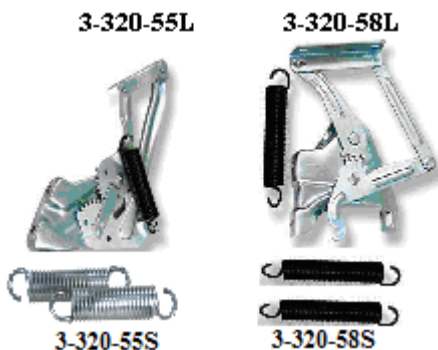

Hood Hinge

3-320-55L	w/ spring	left	55-57	\$119.95	Inquire
3-320-55R	w/ spring	right	55-57	\$119.95	Inquire
3-320-58L	w/ spring	left	58-59	\$144.95	Inquire
3-320-58R	w/ spring	right	58-59	\$144.95	Inquire

Hood Hinge bolt kit---note bolt size on cab-can be 5/16 or 3/8

3-320-55BK	3/8 on cab/5/16 on hood	8 bolts-both sides	55-57	\$24.95	
3-320-58K	5/16	10 bolts-both sides	58-59	\$19.95	

Hood Hinge Springs

3-320-55S	on hinge	pair	55-57	\$44.95	\$10.00
3-320-58S	hooks to fender	pair	58-59	\$44.95	\$10.00

Hood Latch Assembly

3-320-55C	Chev	55-57	\$114.95	\$45.00
3-320-58C	Chev	58-59	\$114.95	\$45.00
3-320-55G	GMC	55-57		Inquire
3-320-58G	GMC	58-59		Inquire

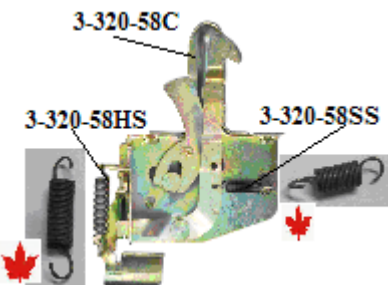

Hood Latch Handle Spring-

3-320-55HS	return spring	55-57		
3-320-58HS	return spring	58-59	\$6.95	

Hood Latch Clock Spring

3-320-55CS	55-57	\$19.95
3-320-58CS	58-59	

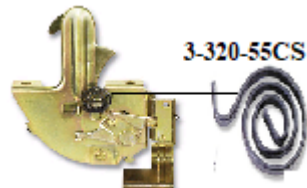

Hood Latch Safety Arm Spring

3-320-55SS	55-57		
3-320-58SS	return spring	55-59	\$6.95

3-320-55C

Hood Brace-X bar in hood

3-321-X	55-59	\$30.00
---------	-------	---------



Cowl Screen Grommet

3-302-G	plug for cowl screen center guide pin in firewall	55-59	\$2.50
---------	---	-------	--------

Cowl Screen Screw set

3-302-S	stainless steel	5 pcs	55-59	\$1.50
---------	-----------------	-------	-------	--------

Bill's Truck Shop

Phone (905) 725-3460 / (905) 725-2022 / Fax (905) 404-2302 email: bill@billstruckshop.com

Instruments

Due to the fluctuation of the Canadian and American dollars call for current prices

Group 4

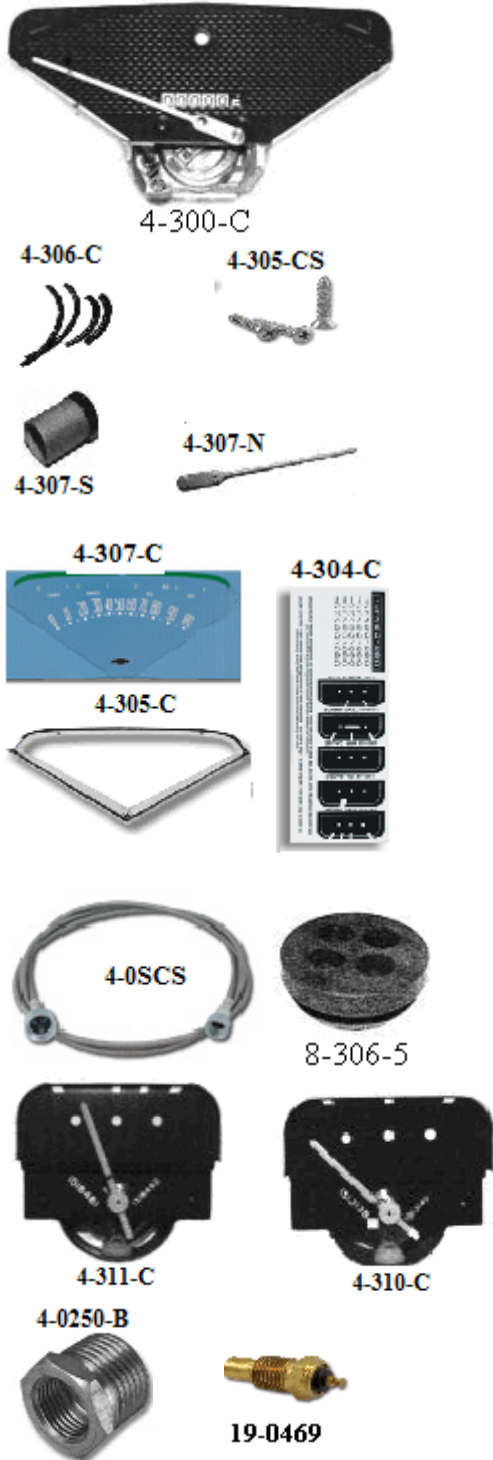

			<u>Year</u>	<u>New</u>	<u>Used</u>
Speedometer Assembly					
4-300-C	Chev		55-59	\$269.95	\$75.00
Gauge Decal Kit Die-cut nylar decals in correct size, shape and colour. Speedometer, odometer, and all gauges/GMC includes tach & clock					
4-304-C	Chev		55-59	\$16.95	
Instrument Bezel w/ screws					
4-305-C	Chev		55-59	\$84.95	\$20.00
Instrument Bezels Screws set					
4-305-CS	3 w/ j-nut	Chev	55-59	\$3.95	
Instrument Bezel Gaskets Between bezel and glass					
4-306-C	Chev		55-59	\$2.25	
Instrument Lens					
4-307-C	Chev		55-59	\$79.95	
Turn Signal Indicator Housings in dash					
4-307-S	cardboard housing w/ green lens	pair	55-59	\$9.95	
Speedometer Needle					
4-308-N	white	Chev	55-59	\$8.50	
Speedometer Cable					
4-0SCP	70 " w/ plastic housing		47-72	\$22.95	
4-0SCS	w/ steel casing	70 "	47-72	\$22.95	
4-0SCP-0	w/ plastic casing	75"	47-72	\$33.95	
4-0SCP-1	w/plastic casing	85"	47-72	\$53.95	
4-0SCP-2	w/plastic casing	100"	47-72	\$55.95	
Speedometer Cable Grommet					
8-306-5	into 4-hole large grommet		55-59	\$2.95	
Fuel Gauge					
4-310-C		Chev	55-59	\$149.95	
Temperature Gauge-please use insulator provided on external side mount plate					
4-311-C	electric type /	Chev	56-59	\$124.95	
4-311-CM	mechanical type/	Chev	55-55	\$129.95	
Temp Gauge Bushing					
4-0250-B		reducer		\$12.95	
Temp Sender w/"T" connector					
19-0469	6 or 8 Cyl—1/2 x 14 NPT	w/ gauges	Late 55-72	\$36.95	
	220 deg	88-72 OHMS			
19-0469-A	6 or 8 cyl 1/2 x 14NPT	w/ gauges-			
	correct resistance for a more accurate OE gauge reading		57-78	\$45.95	

Bill's Truck Shop

Phone (905) 725-3460 / (905) 725-2022 / Fax (905) 404-2302 email: bill@billstruckshop.com

Instruments-ID Plates

Due to the fluctuation of the Canadian and American dollars call for current prices

Group 4



Oil Gauge				
4-312-C	Chev	55-59	\$124.95	
Oil Line kit				
5-0LK	5 ft copper tube w/ fittings	47-72	\$32.95	
68x2	brass block fitting		\$2.75	
Amp Gauge				
4-313-C	Chev	55-59	\$139.00	
Dash Gauge Insulator/warning Label kit				
4-0200-K		47-59	\$1.75	
Gauge Cluster Assembly w/ 58-59 electric temp gauge				
4-315-A	complete w/gauges & speedo Chev only	55-59	\$799.95	
Fuel Gauge Volt Reducer				
4-210-VR	electronic reducer for gauges from 12 to 6 volts	47-55	\$16.00	
Voltage Reducer when changing to 12 volts				
4-210-VRA	for heater motor , radio & accessory	47-55	\$4.50	
Dome Lamp Assembly complete-w/12 V bulb				
4-316-C	chrome housing	55-59	\$43.95	
Dome Lamp Lens				
4-316-L		55-59	\$8.95	
Dome Lamp Bulb				
4-0316-B	12 volt-double contact	55-59	\$2.50	
Cigarette Lighter Assembly				
18-310	w/chrome knob w/o harness	55-59	\$34.95	

NO WARRANTY ON GAUGES IF INSTALLED INCORRECTLY

Bill's Truck Shop

Phone (905) 725-3460 / (905) 725-2022 / Fax (905) 404-2302 email: bill@billstruckshop.com



4-358-C



4-356-C

4-0RIV



ID Plates-etched silver tags shows vehicle manufacture, gross weight, horsepower-provision for stamping neck info 1/2 ton

For- AMERICAN BUILT TRUCKS

4-355-C	Chev 5000 LBS	55-55	\$29.95
4-356-C	Chev 5000 LBS	56-57	\$29.95
4-358-C	235- 6 cyl & 283 -8 cyl Chev 5000 LBS	58-59	\$29.95

For-CANADIAN BUILT TRUCKS

4-355-C/C	Chev 5000 LBS	55-55	Inquire
4-356-C/C	Chev 5000 LBS	56-57	Inquire
4-358-C/ Chev	5000 LBS	58-59	Inquire

Rivets-I.D. Plates- original plug style

4-0RIV	pair	47-59	\$7.95
--------	------	-------	--------

Bill's Truck Shop

Phone (905) 725-3460 / (905) 725-2022 / Fax (905) 404-2302 email: bill@billstruckshop.com

Instruments

Due to the fluctuation of the Canadian and American dollars call for current prices

Group 4



For these rebuilt assemblies contact-Rick
940-300-5235



Oil Gauge

4-312-G	GMC	55-59	\$40.00
---------	-----	-------	---------

Oil Line kit

5-0LK	5 ft copper tube w/ fittings	47-72	\$32.95
68x2	brass block fitting		\$2.75

Amp Gauge

4-313-G	GMC	55-59	Inquire
---------	-----	-------	---------

Speedometer

4-300-G	GMC	55-59	Inquire
---------	-----	-------	---------

Fuel Gauge

4-0310-G	GMC	55-59	Inquire
----------	-----	-------	---------

Clock

4-317-G	GMC		Inquire
---------	-----	--	---------

Gauge Decal Kit Die-cut nylar decals in correct size, shape and colour. Speedometer, odometer, and all gauges/GMC includes tach & clock

4-0304-G	GMC	55-59	\$34.95
----------	-----	-------	---------

Instrument Bezels Screws set

4-305-GS	GMC	12 pcs	55-59	\$4.95
----------	-----	--------	-------	--------

Instrument Bezel Gaskets

4-306-G	housing to dash	GMC	pr	55-59	\$19.95
---------	-----------------	-----	----	-------	---------

INQUIRE ABOUT ANY GMC GAUGE ITEMS

Bill's Truck Shop

Phone (905) 725-3460 / (905) 725-2022 / Fax (905) 404-2302 email: bill@billstruckshop.com

Column-Interior-Dash

Due to the fluctuation of the Canadian and American dollars call for current prices

Group 5

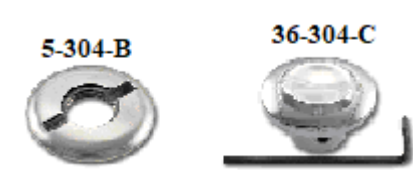
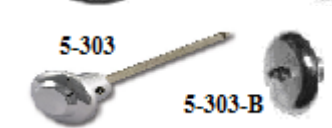
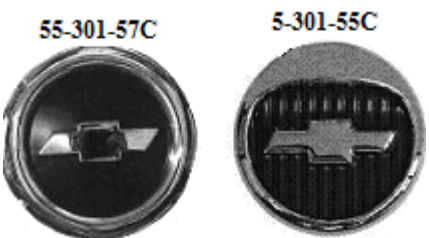

		<u>Year</u>	<u>New</u>	<u>Used</u>
Steering Wheel				
5-0200-54	black	54-56	\$444.95	\$100.00
5-0300-57	black	57-60	\$399.95	\$100.00
Horn Cap – Chevrolet				
5-301-55C	stands 1 ¼ “ tall	55-56	\$76.95	\$30.00
5-301-57C	stands 2 “ tall	57-59	\$76.95	\$30.00
5-301-55G	GMC stands 1 ¼ “ tall	55-56		\$50.00
5-301-57G	GMC stands 2” tall	57-59		\$50.00
Horn Contact & Cap Retainer				
5-0301-3		54-59	\$39.95	
Horn Contact Pin Spring & Bushing				
5-0201-4		47-66	\$12.95	
Steering Wheel Retaining Nut w/ washer				
5-0230-N		47-72	\$1.95	
Spring-Upper Column Bearing				
5-0201-S		47-59	\$9.95	
Light Knob and Rod				
5-303	Chev w/ chrome knob	55-59	\$22.95	\$5.00
5-303-CB	Chev w/ black knob	55-59		\$5.00
5-303-W	GMC w/ white knob	55-59		\$15.00
Light Switch Retainer- Bezel				
5-303-B		55-59	\$16.95	
Wiper Knob				
5-304	chrome w/ 9/32 w/ pentagon hole & set screw	55-59	\$23.95	
5-304-A	black w/pentagon hole w/ set screw /paint white for GMC w/ manual cable control	55-59	\$11.95	
5-304-CW	chrome w/pentagon-hole & original washer button hole w/ set screw	55-59	\$23.95	
Wiper Switch Nut /Bezel				
5-304-B	fits OE & replacement switches	55-59	\$12.95	
Radio Knob & replacement electric wiper switch				
36-309	chrome w/ 3/16 hole & set screw	55-59	\$19.95	
36-309-G	white w/ 3 /16 hole GMC			\$15.00
Turnsignal Lever With Knob approx 46 “ long				
5-305-1	chrome w/ black knob	55-59	\$21.95	
5-305-G	chrome w/ white knob	55-59		\$10.00

Bill's Truck Shop

Phone (905) 725-3460 / (905) 725-2022 / Fax (905) 404-2302 email: bill@billstruckshop.com

Interior-Dash

Due to the fluctuation of the Canadian and American dollars call for current prices

Group 5

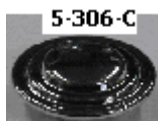

5-0209



5-0209-S



5-307-C



5-308-C

Support-throttle cable

		<u>Year</u>	<u>New</u>	<u>Used</u>
5-308-S	on firewall	55-59		\$10.00

Support

5-0209-S	throttle & choke cable @ carb	47-59		\$20.00
----------	-------------------------------	-------	--	---------

Dash Plug

5-306-C	stainless steel-Chev-GMC	55-59	\$9.95	
---------	--------------------------	-------	--------	--

5-306-G	off white-GMC			
---------	---------------	--	--	--

Throttle Cable Grommet

5-308-G	½ hole in trans tunnel above accel pivot	55-59	\$2.50	
---------	--	-------	--------	--

Cable Lock Stop

5-0209			\$1.50	
--------	--	--	--------	--

Choke Knob With Cable approx. 46" long

5-307-B	w/ black knob	55-59	\$28.95	
---------	---------------	-------	---------	--

5-307-C	w/ chrome knob	55-59	\$29.95	
---------	----------------	-------	---------	--

Throttle Knob With Cable

5-308-B	w/ black knob	55-59	\$26.95	
---------	---------------	-------	---------	--

5-308-C	w/ chrome knob	55-59	\$28.95	
---------	----------------	-------	---------	--

Bill's Truck Shop

Phone (905) 725-3460 / (905) 725-2022 / Fax (905) 404-2302 email: bill@billstruckshop.com

Interior-Dash

Due to the fluctuation of the Canadian and American dollars call for current prices

Group 5

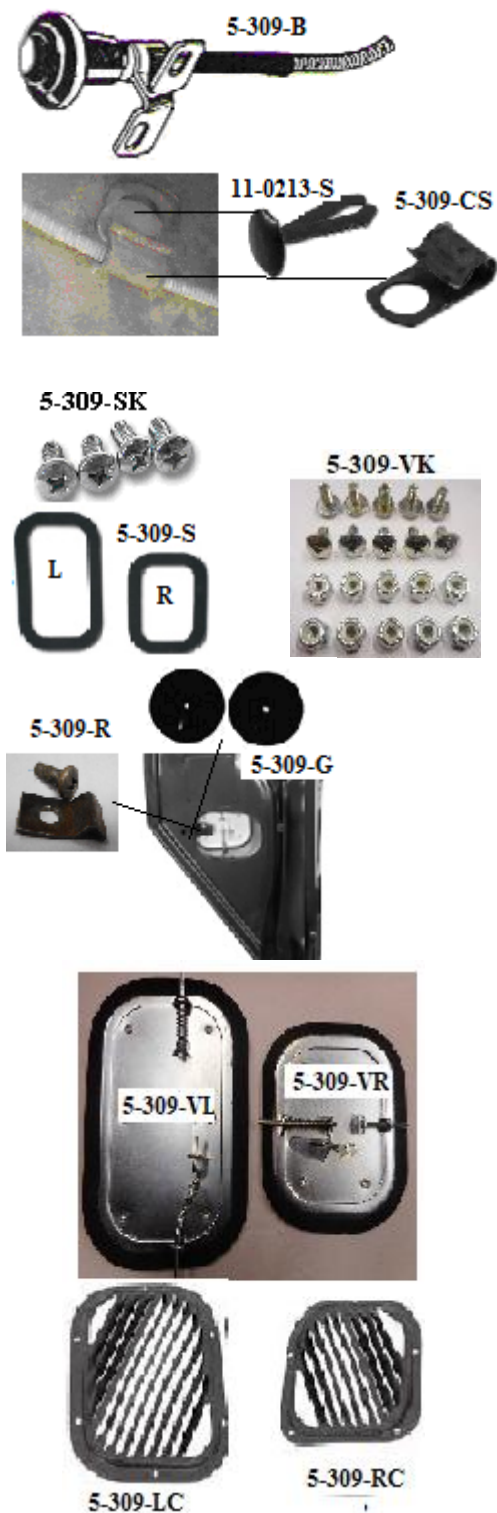

Cowl Vent Knob w/ Cable-fits L or R- approx. 63 "
does not have OE type support

		Year	New	Used
5-309-B	w/ black knob	55-59	\$34.95	
5-309-C	w/ chrome knob	55-59	\$36.95	

Cowl Vent Cable Support Screw kit

5-309-SK	4 screws w/ washers	55-59	\$2.50	
----------	---------------------	-------	--------	--

Cowl Vent Cable Support –L & R cable on firewall

5-309-CS	each	55-59	\$9.95	
----------	------	-------	--------	--

Cowl Vent Cable Grommet @ vent

5-309-G	pair	55-59	\$4.50	
---------	------	-------	--------	--

Cowl Vent Valve Seal Set

5-309-S	replaces flapper seal L & R	pair	55-59	\$6.95
---------	-----------------------------	------	-------	--------

Cowl Vent Valve HDW kit

5-309-VK	screws w/ nylon lock nut to assemble 2 halves when installing new seals	20 pcs	55-59	\$2.95
----------	---	--------	-------	--------

Cowl Vent Cable Retainer @ valve

5-309-R	w/ screw	each	55-59	\$2.50
---------	----------	------	-------	--------

Cowl Vent Cover w/ screws

5-309-LC	mounts vertical	left	55-59	Coming	\$25.00
5-309-RC	mounts horizontal	right	55-59	Coming	\$25.00

Cowl Vent Cover Seal

5-309-VS	black sealer/caulking strips	set	55-59	\$7.95
----------	-------------------------------------	-----	-------	--------

Cowl Vent Cover screw set-both side

5-309-CK	7 stainless screws		55-59	\$2.00
----------	--------------------	--	-------	--------

Cowl Vent Valve

5-309-VL	left	55-59	\$49.95
5-309-VR	right	55-59	\$49.95

Bill's Truck Shop

Phone (905) 725-3460 / (905) 725-2022 / Fax (905) 404-2302 email: bill@billstruckshop.com

Interior-Dash

Due to the fluctuation of the Canadian and American dollars call for current prices

Group 5

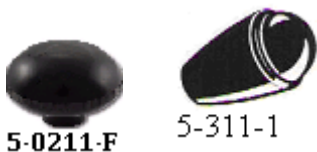

5-313-G



5-313-GH

5-0215-S



5-315



5-0216-K



5-019

5-0220-P

5-0230-N

5-317-G



3-0440-G



Ashtray

			<u>Year</u>	<u>New</u>	<u>Used</u>
5-313-C	Chev		55-59		\$20.00
5-313-G	GMC		55-59		\$40.00

Ashtray Handle

5-313-GH	chrome handle/good used	GMC	55-59		\$25.00
----------	-------------------------	-----	-------	--	---------

Gearshift Knob

5-311-1	3 speed & aut black		55-59		\$12.95
5-0211-F	floor shift-black-can also be used on NAPCO shifter---		40-59		\$16.95

Shift Bracket

5-315			55-59	\$39.95	\$15.00
-------	--	--	-------	---------	---------

Column Shift Bracket Screws

5-0215-S	1/4 x 28- 3/8 fine thread-stainless steel --we now include external countersunk washer to help prevent screw from coming loose	pair	47-59		\$6.95
----------	--	------	-------	--	--------

Column Shift Lever Kit includes pins/springs & bushings

5-0216-K			47-59		\$34.95
----------	--	--	-------	--	---------

Shift Rod Grommet

3-0440-G	with metal lining	each	47-66		\$6.75
5-317-G	set of 4-rubber		55-59		\$6.50

Shifter Boot at shift box

5-019			47-59		\$4.95
-------	--	--	-------	--	--------

Shifter Box Plug

5-0220-P	stainless cap on 3 speed shift box		47-55		\$1.50
----------	------------------------------------	--	-------	--	--------

Steering Column Shifter Lever

5-323	3 speed or Aut		55-59		\$15.00
-------	----------------	--	-------	--	---------

Steering Column Shifter Tube

5-323-T	2 pc shaft w/ joiner		55-59		\$30.00
---------	----------------------	--	-------	--	---------

Steering Wheel Retaining Nut w/ washer

5-0230-N			47-72		\$1.95
----------	--	--	-------	--	--------

Bill's Truck Shop

Phone (905) 725-3460 / (905) 725-2022 / Fax (905) 404-2302 email: bill@billstruckshop.com

Interior-Dash

Due to the fluctuation of the Canadian and American dollars call for current prices

Group 5

Year New Used

5-316-HK



Steering Column Support

5-316-S in quire for 1/2 -3/4 and 2 ton up have a taller support stand

55-59

\$40.00



5-316-S

Steering Column mount hdw kit

5-316-HK washers, spacers, bolts

55-50

\$19.95



5-0316

Steering Column Clamp Bushing

5-0316

55-59

\$3.50

5-0216-P



Steering Column Support Pads-

5-0216-P between column support & dash

pair

54-59

\$3.25



Bill's Truck Shop

Phone (905) 725-3460 / (905) 725-2022 / Fax (905) 404-2302 email: bill@billstruckshop.com

Firewall And Floor

Due to the fluctuation of the Canadian and American dollars call for current prices

Group 7

			<u>Year</u>	<u>New</u>	<u>Used</u>
					
7-0301-55	7-0201-2	7-301-58			
Accelerator Pedal					
7-0301-55			53-57	\$26.95	
7-301-58			58-59	\$26.95	
Accelerator Pedal Pivot Pin and Clip					
7-0201-2			47-57	\$5.95	
Accelerator Pedal Shaft Floor Seal					
7-0201-4			47-59	\$4.95	
					
7-0517	7-0517-S				
Accelerator Rod					
7-0517	Accelerator Rod - pedal to cab- 6 or 8 cyl 15" long	w/ sivel & cotter pins	55-70	\$34.95	
7-0517—S	swivel w/ hdw		55-70	\$5.95	
					
7-0201-4	7-303				
Brake & Clutch Hardware					
7-			55-59		Inquire
Brake & Clutch Pedal Pad					
7-303-1		each	55-59	\$5.95	
Brake & Clutch Floor Shaft Seals					
7-303			55-59	\$5.95	
					
7-303-1	7-003-S				
Clutch-Brake Arm Stop Bumper					
7-003-S	55-59 clutch only	each	47-59	\$2.95	
Brake & Clutch Pedal Bushings (pair)					
7-303-B	brass oversize to repair worn shaft-machine as nec		55-59	\$22.95	
Parking Brake Assembly					
	Original dash mount		55-59		Inquire
Parking Brake Rod Seal -					
7-304-1	at firewall		55-59	\$2.95	
7-304-R	seal retainer w/ screws-coming soon in paintable steel @ brushed stainless steel		55-59	\$10.00	
7-304-RS	brushed stainless steel		55-59		
					
7-304-R	7-304-1				
Park Brake Return Spring					
37-0310-R	spring w/ rod-locates @ center frame support- and 66 early production 9" long		55-65	\$11.95	
37-310-E1	6 ft short bed extension		55-59	\$4.75	
37-310-E2	8 ft extension		55-59		
					
9" long 37-0310-R	38-0219-HS				
37-310-E1					
Park Brake Handle Spring w/hand brake					
38-0219-HS	with brake @ trans		29-59	\$13.95	







Bill's Truck Shop

Phone (905) 725-3460 / (905) 725-2022 / Fax (905) 404-2302 email: bill@billstruckshop.com

Firewall And Floor

Due to the fluctuation of the Canadian and American dollars call for current prices

Group 7

		<u>Year</u>	<u>New</u>	<u>Used</u>
Requires closing shift tube hole w/floor shift				
Steering Column Floor Retainer& Seal				
 7-308-4	column shift includes screws	55-59	\$17.95	
 7-308-S		55-59	\$4.95	
Steering Column Floor Seal only				
Starter Pedal Assembly				
	7-310	55-59		Inquire
Starter Pedal Pad				
	7-0315-P w /foot pedal start-rubber	47-59	\$6.95	
Starter Bellows				
	7-0315	47-59	\$10.95	
Starter Linkage Floor Plug-steel plug on firewall				
 7-315-P	w/ key start starter	55-59		\$10.00
 7-0315				
 7-0315-P				
Clutch Head Driver Set				
 5-0CHSD-4	4 x screw drivers	47-61	\$33.95	
 5-0CHS-4	4 x 3/8 drive sockets	47-61	\$34.95	

Bill's Truck Shop

Phone (905) 725-3460 / (905) 725-2022 / Fax (905) 404-2302 email: bill@billstruckshop.com

Firewall And Floor

Due to the fluctuation of the Canadian and American dollars call for current prices

Group 8



	<u>Year</u>	<u>New</u>
Floor Shift Sponge Seal 4 speed		
6-0FSS	47-66	\$7.95
Floor Shift Boot		
8-0SB-C w/ Chev emblem	47-66	\$28.95
8-0SB-B blank	47-66	NLA
Floor Shift Boot Retainer		
6-0BR 14G brushed stainless steel w/screws	47-66	\$29.95
Hand Brake Sponge Seal		
8-0204-S floor mounted	37-59	\$5.50
Hand Brake Boot		
8-0204-B	47-59	\$18.95
Hand Brake Boot Retainer		
8-0204-R 14G brushed stainless steel w/screws	47-59	\$15.95
Master Cylinder Access Plug		
8-0325	47-59	\$10.95
Main Wire Harness Firewall Grommet		
8-0105 on right firewall @ battery tray-55-59	47-59	\$3.95
Starter Wire Firewall Grommet		
8-306-2 upper firewall on pass side w/ 7/8 hole	55-59	\$3.25
Four Hole Firewall Grommet-check hole size		
8-0206-4 choke/ speedo 1 1/8 " hole at upper left firewall usually 2 required	50-59	\$3.95
8-306-5 vac/speedo/oil 1 1/4 hole check hole size for correct application-also GMC hole size	55-59	\$2.25
Firewall Grommet kit		
8-306-K 1 x 8-0105/8-0206-4/8-306-5/8-306-2	55-59	\$13.95
Transmission Floor Cover		
8-308 3 speed column Shift	55-59	\$129.95
8-308-1 4 speed floor shift	55-59	\$99.95
Transmission Floor Cover Gasket		
8-308-2	55-59	\$14.95
Transmission Floor Cover Screw Set		
8-308-3 9pc	55-59	\$4.95
Battery Hold Down Hardware		
8-309-4 2 bolts and wing nuts and washer	55-59	\$10.95
Battery Box		
8-309-55	55-57	\$72.95
8-309-58	58-59	\$79.95

Bill's Truck Shop

Phone (905) 725-3460 / (905) 725-2022 / Fax (905) 404-2302 email: bill@billstruckshop.com

		<u>Year</u>	<u>New</u>	<u>Used</u>
 <p>8-309-55R</p>	Battery Retainer			
	8-309-55R 10.5" long x 7 " wide	55-57	\$26.95	
 <p>20-0425-R</p>	20-0425-R	58-66	\$19.95	
	Battery Tray Bolt Kit			
 <p>8-0462</p> <p>8-0463</p>	8-309-K OE style washer head bolts/ cadmium plated	55-59	\$6.25	
	Ground Strap -braided as original			
 <p>8-3464</p>	8-0462 battery to body 11 "	47-59	\$37.95	
	8-0463 engine to body 12"	47-59	\$34.95	
 <p>8-3464-C</p> <p>8-3464-B</p> <p>8-3465-C</p> <p>8-3465-B</p>	Battery to Starter # 4 gauge w/12 volt system			
	8-3464-C 6 cyl 30 " long cloth covered	55-59	\$39.95	
 <p>8-0880</p>	8-3464-B 6 cyl 30 " long vinal covered	55-59	\$24.95	
	8-3465-C 8 cyl 52 " long cloth covered	55-59	\$49.95	
 <p>8-0880</p>	8-3465-B 8 cyl 52 " long vinal covered	55-59	\$32.95	
	Battery Cable End-replacement clamp style			
 <p>8-0878</p>	8-0880 battery cable end		\$3.95	
	Battery Adaptors-side post cable to top post battery			
 <p>8-0760-R</p> <p>8-0760-B</p>	8-0878 pair		\$9.95	
	Battery Cable Cover-top post/slip on			
 <p>8-0760-R</p> <p>8-0760-B</p>	8-0760-R red/positive		\$2.95	
	8-0760-B black/neg		\$2.95	

Send us a picture of you truck with some text and we will post it in the gallery on our web site

Glove Box Door/Dash

Due to the fluctuation of the Canadian and American dollars call for current prices

Group 9

			<u>Year</u>	<u>New</u>	<u>Used</u>
	9-301-C				
Glove Box Door w/hinge					
	9-301-C	Chev	55-59	\$139.95	\$50.00
	9-301-G	GMC	55-59		\$75.00
	9-301-HC				
Glove Box Hinge					
	9-301-HC	hinge w/o arms Chev	55-59	\$34.95	
	9-301-HG	hinge w/ arms -GMC	55-59		\$30.00
	9-301-A				
Glove Box Hinge & Arm Screw kit					
	9-301-SK	10 screws w/ washers	55-59	\$4.95	
	9-301-SK				
Glove Box Arms					
	9-301-A	pair	55-59	\$34.95	
Glove Box Liner					
	9-302-C	Chev	55-59	\$24.95	
	9-302-G	GMC	55-59	\$24.95	
	9-301-5				
Glove Box Mounting Screws					
	9-301-5	set of 7	55-59	\$6.95	
	9-302-C				
Glove Box Door Bumpers					
	5-0GBB	pair	47-72	\$2.50	
Glove Box Lock & Key					
	5-0221	w/o key	54-72	\$26.95	
	5-0222	Original Style w 2 keys	54-72	\$43.95	\$15.00
	5-0222				
Glove Box Lock Gasket					
	5-0223		54-72	\$1.50	
Glove Box Lock Retainer Bracket & Screw					
	5-0224		54-72	\$3.95	\$1.00
Glove Box Lock Striker					
	9-0201-13		54-59	\$8.95	
Glove Box Light Kit					
	5-0GBL		54-72	\$19.95	
	5-0GBB				
	5-0GBL				

Bill's Truck Shop

Phone (905) 725-3460 / (905) 725-2022 / Fax (905) 404-2302 email: bill@billstruckshop.com

Interior Parts

Due to the fluctuation of the Canadian and American dollars call for current prices

Group 10



		<u>Year</u>	<u>New</u>	<u>Used</u>
Headliner w/ original style pattern				
10-305-B	black –plastic	55-59	\$69.95	
10-305-W	white	55-59	\$69.95	
10-305-R	red	55-59	Inquire	
Headliner Retainer Seal				
10-306-B	black rubber seal	55-59	\$42.95	
10-306-W	off-white rubber seal –because the white yellows after a short period of time we no longer carry them –we are trying to locate a better product	55-59	NLA	
Headliner Insulation				
10-305-I		55-59	\$32.95	
This original replacement water resistant pressboard headliner is covered with Madrid Grain Vinyl with dielectric heated sealed seams installed w/ Velcro (provided) and original rubber seal (add to order)				
10-305-2295	black	55-59	\$194.95	
10-305-4545	maroon	55-59	\$194.95	
10-305-0511	red	55-59	\$194.95	
10-305-4489	navy blue	55-59	\$194.95	
10-305-2309	medium blue	55-59	\$194.95	
10-305-3608	light blue	55-59	\$194.95	
10-305-90022	palomino	55-59	\$194.95	
10-305-4533	dark saddle—special order	55-59	\$194.95	
10-305-6758	medium grey	55-59	\$194.95	
10-305-0702	charcoal	55-59	\$194.95	
10-305-4544	saddle	55-59	\$194.95	
Armrest w-hardware				
10-0204-BK	black	55-66	\$64.95	
10-0204-BR	brown	55-66	\$64.95	
10-0204-G	grey	55-66	\$64.95	
10-0204-R	red w/ beige base	55-66	\$69.95	
Armrest Screw				
9-0773-AS	¼ x 20 x 1 ¼ philips screw	pair	47-72	\$2.00
Armrest Nut				
9-0773-AN	cage nut	pair	47-72	\$4.95

Bill's Truck Shop

Phone (905) 725-3460 / (905) 725-2022 / Fax (905) 404-2302 email: bill@billstruckshop.com



When ordering seat belts there are many issues that will have to be addressed –eg-buckets-bench-height of seat-mount location etc / note- 3 point system lock buckle must be on side of person

Some applications may require an extender-see below for 6” metal ext or 12” belt extension

Seat Belts /lap style-w/ hdw.-per person

Push button STD (coloured) 22”long w/female end & 38” long w/ male end // or lift lever (chrome) type DLX 22” long male end & 38” long female end- 60 “ DLX 42” long male end & 30” long female end-72”

SB-N2PB	black w/ std buckle	\$74.95
SB-N2PR	red w/ std buckle	\$74.95
SB-N2PG	grey w/ std buckle	\$74.95
SB-N2PT	tan w/ std buckle	\$74.95
SB-N2PN	navy blue w std buckle	\$74.95
SB-N2PM	maroon w/ std buckle	\$74.95
SB-N2LB	black w/chrome buckle	\$89.95
SB-N2LB-72	black w/chrome buckle 72” long	\$89.95
SB-N2LG	grey w/ chrome buckle	\$89.95
SB-N2LN	navy blue w/chrome buckle	\$89.95
SB-N2LN-72	blue w/chrome buckle 72” long	\$89.95
SB-N2LR	red w/ chrome buckle	\$89.95
SB-N2LTAN	tan w/ chrome buckle	\$89.95

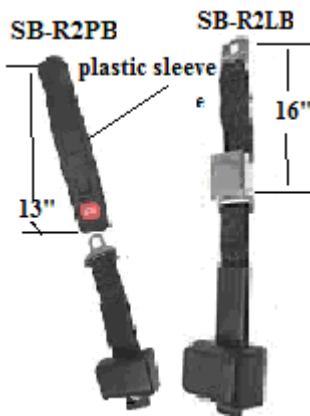

2-point retractable w/ hdw-- 13 “ female w/ plastic sleeve/16” w/ loose end

Push button STD or lift lever (chrome) type DLX

SB-R2PB	black w/ std buckle	each	\$126.95
SB-R2PR	red w/ std buckle	each	\$126.95
SB-R2PG	grey w/ std buckle	each	\$126.95
SB-R2PT	tan w/ std buckle	each	\$126.95
SB-R2PM	maroon w/ std buckle	each	\$126.95
SB-R2PN	blue w/ std buckle	each	\$126.95
SB-R2LB	black w/ dlx	each	\$126.95
SB-R2LR	red w/ dlx	each	\$126.95
SB-R2LT	tan w/ dlx	each	\$126.95
SB-R2LG	gray w/ dlx	each	\$126.95

Interior-Seat Belts

Group 11

Year New Used

When ordering seat belts there are many issues that will have to be addressed –eg-buckets-bench-height of seat-mount location etc / note- 3 point system lock buckle must be on side of person

Some applications may require an extender-see below for 6” metal ext or 12” belt extension



SB-R3LB

3-point retractable w /hdw and chrome lift latch (air plane style) approx 24” inner female

SB-R3LB black w/ chrome buckle each \$249.95

SB-R3LDB dark blue w/chrome buckle each \$234.95

3-point retractable w /hdw

Push button STD (coloured) or lift lever (chrome) type DLX

SB-R3PB black w/ std buckle each \$209.95

SB-R3PG gray w/ std buckle each \$209.95

SB-R3PM maroon w/ std buckle each \$209.95

SB-R3PT tan w/ standard buckle each \$209.95

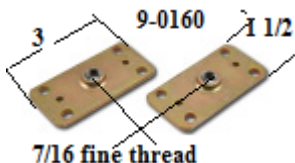

7/16 fine thread

2 1/2 between holes
FAB-1001-3



BTS
EXCLUSIVE



FAB-1008-1

Anchor Plates

9-0160 w/ shoulder belt -7/16 fine thread / pr 47-66 \$29.95

Belt Extension w/ hdw

SB-12XBK black \$21.95

SB-12XBL navy blue \$21.95

SB-12XR red \$21.95

SB-12XT tan Inquire

SB-12XG gray \$21.95



SB-12XBK

Metal Extension

FAB-1008-1 1 “ 90 deg “ ext \$9.95

FAB-1001-3 8 “ ext w/3 holes @ 2 1/2 apart- cut to desired length as required \$11.95

Seat Belt Retractors-pr a reproduction of an OE option- for non retractable seat belts-prevents belt from falling out vehicle doors

9-0SBR pair \$34.95



9-0SBR

Bill's Truck Shop

Phone (905) 725-3460 / (905) 725-2022 / Fax (905) 404-2302 email: bill@billstruckshop.com

Interior Parts

Due to the fluctuation of the Canadian and American dollars call for current prices

Group 11

11-0205-BK



11-0205-C



include w/ new visors

11-3275-90022



includes screws w/ new

11-205-R



11-0205-2

Sun Visors includes end clips each

11-0205-BK	black	47-59	\$49.95
11-0205-BR	brown	47-59	\$49.95
11-0205-G	grey	47-59	\$49.95
11-0205-M	maroon	47-59	\$49.95
11-0205-R	red	47-59	\$49.95

Special order --madrid grain vinal-sold as a pr

11-3275-2295	black	55-59	\$179.95
11-3275-4545	maroon	55-59	\$179.95
11-3275-0511	red	55-59	\$179.95
11-3275-4489	navy blue	55-59	\$179.95
11-3275-3608	light blue	55-59	\$179.95
11-3275-2309	medium blue	55-59	\$179.95
11-3275-90022	palomino	55-59	\$179.95
11-3275-4533	dark saddle	55-59	\$179.95
11-3275-6758	medium grey	55-59	\$179.95
11-3275-0702	charcoal	55-59	\$179.95

Sun Visor Bracket - chrome with screws

11-305-L		55-59	\$29.95
11-305-R		55-59	\$29.95

Sun Visor Bracket Screw kit

11-0205-2	3 pcs	47-59	\$0.95
-----------	-------	-------	--------

Sun Visor End Clips

Stainless-steel clips for uncovered visor.

11-0205-C	pair	47-66	\$3.50
-----------	------	-------	--------

Bill's Truck Shop

Phone (905) 725-3460 / (905) 725-2022 / Fax (905) 404-2302 email: bill@billstruckshop.com

inquire about other colour combinations & vinyl-cloth

SEAT COVERS

Cover Heavy Duty vinyl similar to original colour and grain w/stitched foam backing –madrid vinyl *inquire about other colour combinations*



11-207



madrid vinal



sample

11-306-BKV-P	black pleated vinyl	55-59	\$495.95
11-306-BKV	black non pleated vinyl	55-59	\$449.95
11-306-DSV	dark saddle non pleated vinal	55-59	\$449.95
11-306-LBV-P	light blue w/ pleats	55-59	\$495.95
11-306-BK2	black scottsdale velour inserts w/o pleats w/ black vinyl trim	55.59	\$499.95

Piping can be added to edge in all colours- inquire-there is \$125.00 extra charge

11-0PIP \$125.00

ECONOMY SEAT COVER

Seat Cover	replacement- vinyl cover only		
11-307-BV	black vinyl	55-59	\$269.95
11-307-BNV	brown vinyl	55-59	\$269.95
11-307-GRV	gray vinyl	55-59	\$269.95

Seat Upholstery Installation Kit

11-307-K	includes burlap and cotton padding-used when installing all venal seat cover	55-59	\$24.95
11-307-B	burlap only 12 ft section for both halves	55-59	\$16.95

Seat Cover-CAMEO style 2 tone velour/cloth/vinyl

11-306-BK2	black Scottsdale cloth w/ black madrid vinyl subs w/ out pleats	55-59	\$544.95
11-306-BK2-P	black Scottsdale (encore) velour w/ black madrid vinyl subs w/ pleats	55-59	\$544.95
11-306-RB2	royal blue velour w/ white madrid vinal subs w/o pleats	55-59	\$544.95

Many other colour combinations available
Call for sample pictures of material and seats



11-0SC

Seat to Frame Clip kit

11-0SC	70 pieces	39-59	\$18.50
--------	-----------	-------	---------

Interior Parts

Due to the fluctuation of the Canadian and American dollars call for current prices

Group 11

			<u>Year</u>	<u>New</u>	<u>Used</u>
	11-0307-H				
Seat Spring Tie Clip					
	11-0209	secures spring together	set of 3	47-72	\$1.95
Seat Frame Filler Plug					
	11-308	rubber seat frame end caps	-pr	55-59	\$25.95
Seat Track					
	11-308-T	seat track w/ adj rod	pr	55-59	\$125.00
Seat Track Adj Rod					
	11-308-R	original steel rod between track		55-59	\$10.00
Seat Adjuster cable kit					
	8-0070	Cable-seat adjust kit w/ adjustable turnbuckle		50-87	\$12.95
Seat Rod Spring					
	11-308-RS	secures rod to seat base		55-59	
Seat Adjust Handle					
	11-0307-H	stainless steel w/ hdw		55-66	\$38.00
Seat Frame Assembly					
	11-308-F			55-59	\$200.00
Seat Return Spring					
	11-0307-S			55-80	\$11.95
Seat Cushion Spring-lower					
	11-308-CS	vertical coil spring		55-59	\$5.00
Seat Arm Pivot Bolt					
	11-308-PB	w/ shim and spacer	each	55-59	\$3.00
Springs NEW					
	11-0207-S	seat base coil tension spring-set of 4		47-59	\$14.95
		Secures the standing springs			









Bill's Truck Shop

Phone (905) 725-3460 / (905) 725-2022 / Fax (905) 404-2302 email: bill@billstruckshop.com

Interior Parts

Due to the fluctuation of the Canadian and American dollars call for current prices

Group 11

		<u>Year</u>	<u>New</u>	<u>Used</u>
Carpets with Underlay				
Cut to fit with edges sewn & underlay- inquire about many other colours- LOOP PILE - also available in NYLON CUP PILE				
Also note w/ high hump floor-add HH (4 speed)				
All carpet are extra long for no gas tank				
Can also be ordered w/o holes for pedals -- NH				
	11-310			
	11-312-FM			
	11-311-3			
	11-312-SD			
	11-0HSD			
	11-313			
	11-313-R			
	11-0213-S			
CARPET- 2 yards – call for other colours				
8-000Y-01	black-loop pile	approx 80 “ x 72”		\$144.95
10782	Dimmer switch grommet-(included w/ new carpet)			\$8.95
Sill Plates aluminum-bright polished machined w/ screws-secures carpet/rubber mat to rocker step edge---see picture on bottom of page				
11-3076	front left and right	pair	55-59	\$278.95
11-3077	rear	each	55-59	\$64.95
Rubber Floor mat				
11-311-3	automatic or 3 speed std	black	55-59	\$239.95
11-311-4	4 speed w/ HH	NEW VINAL includes felt backing-w/o holes-may require some edge trimming	55-59	\$269.95
Felt Mat				
11-312-FM	helps reduce noise & heat		55-59	\$44.95
Sound Deadener				
11-312-SD	Floor Deadener kit-Die-cut asphalt based material w/ foam liner		55-59	\$109.95
11-0HSD	Universal heat & sound insulation – 3/8 single sided foil backed w/ jute liner	4 x 6		\$47.95
Inner Firewall Cover				
Pre-cut rubber and felt laminated on one sheet.				
11-313			55-59	\$79.95
Inner Firewall Cover Retainers				
11-313-R	may require hole enlargement--	plastic (9)	55-59	\$11.95
11-0213-S	OE metal type-each		47-59	\$6.50

Bill's Truck Shop

Phone (905) 725-3460 / (905) 725-2022 / Fax (905) 404-2302 email: bill@billstruckshop.com



Door Parts

Due to the fluctuation of the Canadian and American dollars call for current prices

Group 12



			<u>Year</u>	<u>New</u>	<u>Used</u>
Inside Door Handle (each) with a set screw					
12-01DH	chrome		47-66	\$26.95	
Inside Window Handle with set screw					
12-01WH	chrome black knob		47-66	\$24.95	
Inside Handle Gasket Set					
12-01HG	sponge seals & fibre washers		47-66	\$6.95	
Interior Handle Escutcheon					
12-01HE	grey	each	47-87	\$2.95	
Inside Handle Set Screw for OE handles only- some applications used a 2nd lock set screw above					
12-0204	1/4 x 20 hex head	each	47-66	\$0.60	
12-0204-S	set screw 1/4-20x3/8		47-66	\$0.60	
Outside Door Handles (with gaskets & screws)					
12-0107	w/out right side button / lock	pair	52-59	\$94.95	
12-0107-1	for rear on panel/suburban door w/o button or lock		52-59	\$49.95	
Door Handle (outer)screw kit- 8 pcs					
12-0025-HK			52-72	\$3.50	
Outside Door Lock With Key (2 keys)					
12-305-1	front doors and rear door on panel /suburban single door lock w/ 1 7/8 shaft length		55-59	\$64.95	
12-305-2	2 door locks- can be used on ft & rear door		55-59	\$129.95	
12-305-3	ignition cylinder/glove box & 2 door locks		55-59	\$164.95	
Outside Handle Gasket Set					
12-0205			52-66	\$2.95	
Outside Handle Scratch Shields Chrome Plated					
12-0185		pair	52-59	\$38.95	
Vent Handle Kit Chrome plated with pin and washer					
12-306-L		left	55-59	\$22.95	
12-306-R		right	55-59	\$22.95	
Vent Handle Roll Pin					
12-0996		each	51-72	\$0.30	

Bill's Truck Shop

Phone (905) 725-3460 / (905) 725-2022 / Fax (905) 404-2302 email: bill@billstruckshop.com

Door Parts

Due to the fluctuation of the Canadian and American dollars call for current prices

Group 12

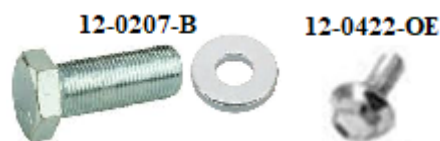
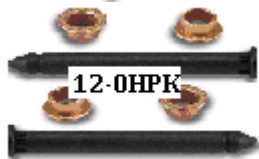
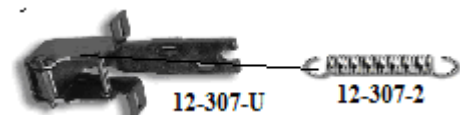

Door Hinges

			Year	New	Used
12-307-L	fits L or R Lower	each	55-59	\$99.95	
12-307-U	fits L or R upper (w/ door check)	each	55-59	\$99.95	

Door Hinge Rebuilt Kit

12-0HPK	2 (11/32) pins / 4 (13/32) OS brass bushing		47-87	\$12.95	
---------	---	--	-------	---------	--

Door Hinge Check Spring

12-307-2	on upper door hinge	each	55-59	\$2.50	
----------	---------------------	------	-------	--------	--

Door Hinge Cage Nut **new item**

12-0307-CN	3/8 fine thread rectangular nut	each	55-59	\$17.95	
------------	---------------------------------	------	-------	---------	--

Door Hinge Bolts **OE is all fine thread-thicker part of hinge requires the longer bolt**

12-0422-OE	OE style w/ floating washer head	3/8 fine-1" long	each	55-59	\$2.95
12-0207-B	replacement style	3/8 x 1 fine thread w/ washer	each	55-59	\$1.00

Lower Door Drain Plug

12-310	set of 4		55-59	\$14.95	
--------	----------	--	-------	---------	--

Lower Hinge Access Panels –single available

ONLY while supplies last 12-307-LP & RP

12-307-PR	L m& R pair		55-59	\$36.95	
12-307-S	panel screws	stainless steel	8pcs	55-59	\$2.95

Bill's Truck Shop

Phone (905) 725-3460 / (905) 725-2022 / Fax (905) 404-2302 email: bill@billstruckshop.com



The easy latch kit is a vehicle specific bolt-on, bear jaw rotary claw latch kit. This kit features contoured jam plates to match the features of your vehicles doors. These are in no way a universal application. The bear jaw rotary claw latches are each designed to work with the exterior handles, interior handles, and the exterior door lock cylinders of the specified vehicles. Each piece of the bear jaw latches are zinc plated to fight corrosion. The internal claws are case hardened and black oxide coated. Each kit comes with everything you need for two doors. Latch plates, vehicle specific bear jaw rotary claw latches, templates, hardware, detailed instructions, striker plates, and even stainless steel striker bolts. The Easy Latch kit will have your doors opening and closing smoothly and safely. All of the kits are designed, manufactured, and assembled here in the US

Most of our Altman Easy Latch Kits jam plates are available in your choice of paint to match steel or mirror polished stainless steel.

Altman Easy Latch kit

12-308-A

<u>Year</u>	<u>New</u>	<u>Used</u>
55-59	\$519.95	



PANEL & SURBURBAN REAR DOORS/HATCH

Rear door hinges up/lower—left/right

55-59

Inquire

12-325-???

Bolt kit-rear door hinge 18 pc per hinge

12-325-BK









55-59

\$6.75

Door Parts

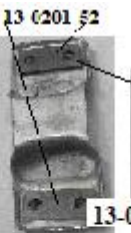
Due to the fluctuation of the Canadian and American dollars call for current prices

Group 12

			<u>Year</u>	<u>New</u>	<u>Used</u>
12-308-L					
12-0208-3					
12-0DLC					
Door Latch-----door latch & strikers CANNOT be used to adjust door fitment					
12-308-L		Left	55-59	\$69.95	
12-308-R		Right	55-59	\$69.95	
12-308-1R		panel / suburban rear door	55-59	\$69.95	
Door Latch Screw Kit					
12-0208-3		3 pcs per side	52-59	\$2.50	
Door Latch Repair Clip -					
12-0DLC		corrects a lot of door closing issues	each	47-63	\$10.95
Door Striker- mounts on door jamb (each)					
12-0629-PR		sold as pair only	52-63	\$29.95	
12-0629-R		fits panel / suburban with rear barn doors	52-63	\$14.95	
5/16-18 coarse thread ---- 5/16-24 fine thread					
1/4-20 coarse thread-----1/4-28 fine thread					
PLEASE CHECK BEFORE ORDERING -type of hdw -OE info 1/4 -20 NC SCREWS OR 5/16-24 NF SCREWS @ STRIKER					
12-0629-L					
13-0201-52					
12-0201-N					
12-0630					
Door Striker Screw Kit -late 57 up did not use 1/4-20 clutch driver screws-used 5/16 -24 UNF hex low washer head bolts					
12-0630		4 screws w/ washers 1/4 -20 NC per side	52-early 57		
Door Striker Hdw kit					
12-0630-K		4 x 1/4-20 NC Philips drive screws w/ washer,shims & nut plates	1 side	52-early 57	\$19.95
Door Striker Nut Plate					
12-0201-N		threaded (1/4 -20) plate in backside of "B" pillar for striker screws	pair	47-early 57	
Door Striker hdw kit					
12-0631-K					
12-0631-K		4x 5/16-18 NC-clutch head stainless screws-4 washers,2 shims & 2 nut plates	per side	Late 57-59	
Door Striker Shims					
13-0201-52					
13-0201-52		1/8 x 1 7/16 long x 3/4 wide behind both ends of the striker for correct latch contact	pair	52-63	\$5.95

Bill's Truck Shop

Phone (905) 725-3460 / (905) 725-2022 / Fax (905) 404-2302 email: bill@billstruckshop.com

Door Parts

Due to the fluctuation of the Canadian and American dollars call for current prices

Group 12

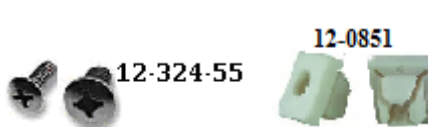
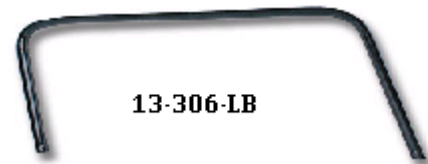
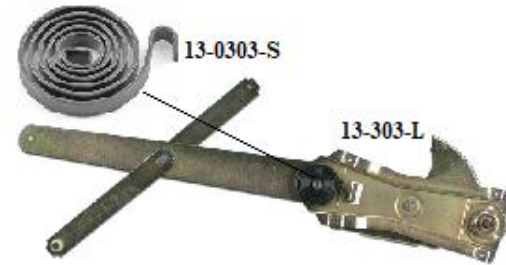

Door Control

12-305-L	left	55-59	\$42.95
12-305-R	right	55-59	\$42.95

Door Control Hdw kit -both sides

12-0205-K	6(zinc) screws w/ tooth washer-Philips drive	47-72	\$2.95
-----------	--	-------	--------

13-0302-R	roller & pin	55-63	\$6.25
-----------	--------------	-------	--------

Window Regulator

13-303-L	left	55-59	\$99.95	\$50.00
13-303-R	right	55-59	\$99.95	\$50.00

Window Regulator Hdw Install kit

13-0203-SK	per side	51-72	\$2.75
------------	----------	-------	--------

Window Regulator Gear Assembly w/ rivets

13-0303-G		55-63	\$58.95
-----------	--	-------	---------

Window Regulator Assist Spring

13-0303-S	at handle shaft	55-87	\$5.00
-----------	-----------------	-------	--------

Door Window Moulding -Inner

13-306-LB	black	55-59	\$82.95	\$50.00
13-306-RB	black	55-59	\$82.95	\$50.00
13-306-LC	chrome	55-59	\$114.95	
13-306-RC	chrome	55-59	\$114.95	

Door Moulding Fastener Set-clips/screws/j-nuts

13-307	both doors	55-59	\$18.95
--------	------------	-------	---------

Door Panel

12-320-L		55-59	\$148.95	\$75.00
12-320-R		55-59	\$148.95	\$75.00

Door Panel Screw Set

12-324-55	stainless steel screws # 10 & ¼ 24UNC per door	55-55	\$9.95
12-0324-56	stainless steel screws ¼- 20 UNC--- 2 doors	56-66	\$23.95
12-0851	Nuts- to replace missing or damaged door panel pair	56-71	\$1.45

Bill's Truck Shop

Phone (905) 725-3460 / (905) 725-2022 / Fax (905) 404-2302 email: bill@billstruckshop.com



13-0PW-HS



Power Windows- includes chrome switches, wiring harness, US made Sieman motors on original style window regulators w/ complete instructions- Brass iolite thrust bearings at pivots-mfg. by Nu-Relics

13-359-PW	w/chrome switches	55-59	\$984.95
13-359-PW/CS	w/ crank handles switches	55-59	\$999.95

Crank Handle Switches

13-0PW-HS	check shaft length	pair	40-72	\$225.00
-----------	--------------------	------	-------	----------

One Piece Glass

See product info below

1955-59	Power window kit w/ 1 pc glass	Inquire
13-3PW-1T		

Bill's Truck Shop

Phone (905) 725-3460 / (905) 725-2022 / Fax (905) 404-2302 email: bill@billstruckshop.com

This electric kit includes the following for the 1955, 56, 57, 58, and 59 Chevy truck: 2 side windows - choose color, 2 lower glass run channels and 2 electric lift channels attached to window glass, 2 front vent channels with 2 brackets, screws and nuts, 2 upper U felts (bent to fit), 4 lower felts with clips installed, left and right motor with left and right installed brackets, left and right switches with complete wiring and door post wire guides. Easy to follow written instructions with pictures. These are tempered glass only w/ Specialty Power windows drive system

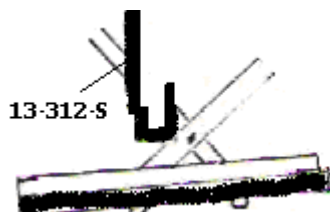
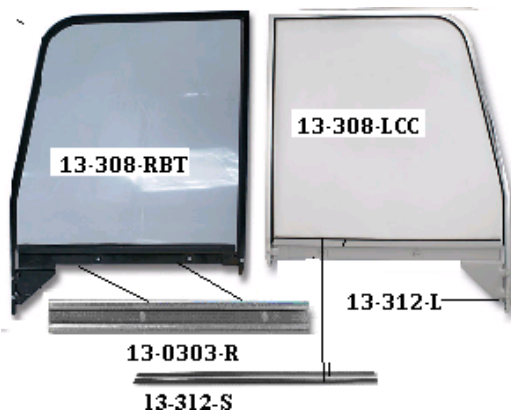

Door Glass Frame w / glass & sash-----new assembly DO NOT come w/ sash seal # 13-312-S

13-308-LCT	chrome	w/tinted glass	left	55-59	\$279.95	Inquire
13-308-RCT	chrome	w/ tinted glass	right	55-59	\$279.95	Inquire
13-308-LCC	chrome	w/clear glass	left	55-59	\$279.95	Inquire
13-308-RCC	chrome	w/clear glass	right	55-59	\$279.95	Inquire
13-308-LBT	black	w/tinted glass	left	55-59	\$279.95	Inquire
13-308-RBT	black	w/tinted glass	right	55-59	\$279.95	Inquire
13-308-LBC	black	w/clear glass	left	55-59	\$259.95	Inquire
13-308-RBC	black	w/ clear glass	right	55-59	\$259.95	Inquire

Door Glass Frame Screws (barrel nut & screw)

13-0208		each	47-63	\$1.50
---------	--	------	-------	--------

Door Glass Sash- steel frame on lower glass (each)

13-312-L		left	55-59	\$59.95
13-312-R		right	55-59	\$59.95

Window Regulator Roller Guide Rail

13-0303-R		fits L and R	55-63	\$41.95	\$15.00
-----------	--	--------------	-------	---------	---------

Screw –window guide to sash kit- 4 screws w/ washers

13-0303-SK		both sides	55-63	\$3.95
------------	--	------------	-------	--------

Door Glass Guide Channel rear of door below handle

13-312-4L			55-59	\$30.00
13-312-4R			55-59	\$30.00

Door Glass Sash Seal

13-312-S	& secures glass into sash	each	55-59	\$8.95
----------	---------------------------	------	-------	--------



Vent Window Assembly

13-313-TLC	tinted glass w/ chrome vent frame-left	55-59	\$449.95	\$125.00
13-313-TRC	tinted glass w / chrome vent frame-right	55-59	\$449.95	\$125.00
13-313-CRC	clear glass w/ chrome vent frame-right	55-59	\$469.95	\$125.00
13-313-CLC	clear glass w/ chrome vent frame-left	55-59	\$469.95	\$125.00

NOTE-adjust vent post tension spring before installation

Vent Window Ass install kit-2 doors

13-313-SK	stainless steel	55-59	\$6.95	
-----------	-----------------	-------	--------	--

Vent Glass Frame w/o vent handle -requires

1-0GST glass setting tape-1/12 W x 0.062 thick

13-314-LCT	left- w/ tinted glass	chrome	55-59	\$145.00
13-314-RCT	right-w/tinted glass	chrome	55-59	NLA

13-314-LC	left w/o glass	chrome	55-59	NLA
13-314-RC	right w/o glass	chrome	55-59	\$79.95

Spring-Vent Window Frame Tension Spring

13-0213-S		51-91	\$11.95	
-----------	--	-------	---------	--

Fuel Tank & Parts

Due to the fluctuation of the Canadian and American dollars call for current prices

Group 14



		<u>Year</u>	<u>New</u>
Gas Tank kit- 19 gallons-top right of centre fill-rear frame mount w/ hdw internal baffles ,zinc plated, silver painted			
14-300-K does not includer fuel sender		55-59	\$599.95
34 " long 18 " wide 13 " deep w/ step on side to frame mount			
Gas Tank-galvanized 18gal			
14-301 pickup		55-59	\$389.95
14-301-PS suburban / panel		55-59	
Gas Tank Straps			
14-301-S pair		55-59	\$69.95
Gas Tank Strap bolt kit			
14-301-SHK 4 bolts w/ washers		55-59	\$5.95
Gas Tank Insulator kit			
14-0GTP 2" x 40 " pair		47-66	\$9.95
Gas Tank Filler kit			
14-302-K includes pipe-hose-grommet-cap		55-59	\$109.95
Gas Tank Floor Seal Donut -seals between gas tank and fuel line/drain hole in floor			
14-0305		49-59	\$2.25
Gas Tank Filler Neck Pipes			
14-302 pickup		55-59	
Gas Tank Filler Neck Grommet			
14-302-3 pickup		55-59	\$8.95
Gas Tank Filler & Vent Hose-clamps not included			
14-0212 also fits 55-59 panel & sub 2pcs		49-59	\$19.95
Gas Tank Filler Hose Clamp			
14-0212-C correct OE style 4pcs		49-59	\$12.95
14-0212-S screw type hose clamps		49-59	\$5.95
Fuel Line Grommet			
14-0425 OD 1-ID3/4-w/ 3/8 hole - at floor		49-59	\$2.95
Gas Tank Sender Wire Grommet			
14-0415 OD 1 -ID 11/16 w/5/16 hole - at floor		49-59	\$2.50
Flexible Fuel Line under tank			
14-0203-3		54-59	\$29.95
Fuel Tank Line			
14-303-L 5/16 line w/ fittings		55-59	\$19.95
Fuel Fill Delete plate			
14-00GD weld in/when relocating fuel tank		55-66	\$23.95

Bill's Truck Shop

Phone (905) 725-3460 / (905) 725-2022 / Fax (905) 404-2302 email: bill@billstruckshop.com

Fuel Tank & Parts

Due to the fluctuation of the Canadian and American dollars call for current prices

Group 14



			<u>Year</u>	<u>New</u>	<u>Used</u>
Gas Tank Sender Unit w/ gasket					
14-304	w/ fuel pickup	30 ohm pickup	55-59	\$58.95	
14-304-PS	panel and suburban	30 ohm	55-59	\$69.95	
14-0204-90	universal application	-90 ohm		\$64.95	
14-0204-30	universal application	-30 ohm		\$64.95	
Fuel Sender Pickup Screen					
6-0204-S	OE metal type	for 5/16 line	54-72	\$28.95	
Gas Tank Sender Unit Gasket					
14-0593			47-66	\$2.50	
Gas Tank Sender Screw Kit					
14-0594			47-66	\$3.00	
Gas Tank Sender Float					
6-0204		brass	47-72	\$11.95	
Fuel Door Bumper					
6-0210	panel & suburban	pair	55-59	\$4.00	
Gas Cap – Original Type vented					
6-0GCS	stainless steel	NEW PRICE!!	47-70	\$15.95	
6-0GCP	paint to match		47-70	\$27.00	
Locking Gas Cap—non vented					
14-0416	chrome w/ bowtie	lock cover	47-70	\$55.95	
14-0417	chrome	-smooth w/2 keys	47-70	\$22.95	
Cool Cap					
14-0FCC	flush mount, billet aluminium,	screw cap w/ 1 1/2 fill neck, 3" flange		NON venting	\$99.95
14-00FH	fuel hose/ neoprene	4" long x 1 1/2 ID w/ clamps			\$16.95

Bill's Truck Shop

Phone (905) 725-3460 / (905) 725-2022 / Fax (905) 404-2302 email: bill@billstruckshop.com

SPARE TIRE

Due to the fluctuation of the Canadian and American dollars call for current prices

Group 14

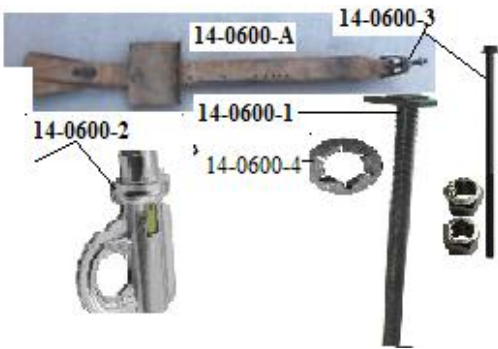

SPARE TIRE HARDWARE

Grommet

14-0610 for support brace in fender –short step side trucks fits 1 ¾ hole

		<u>Year</u>	<u>New</u>	<u>Used</u>
14-0610	for support brace in fender –short step side trucks fits 1 ¾ hole	55-66	\$7.95	
14-0600-A	tire support assembly w/ pivot bolt	53-59		\$125.00
14-0600-1	bolt –support release bolt	54-87	\$22.95	\$10.00
14-0600-2	nut-lock bolt nut w/ nylon insert	54-87	\$12.95	\$5.00
14-0600-3	bolt-tire support pivot	54-87	\$22.95	\$5.00
14-0604-15	tire support on L fender 15 “wheels	54-87		Inquire
14-0604-16	tire support on L fender 16 “ wheels	54-87		Inquire
14-3604	tire support in bed---fleetside	58-59		\$75.00

Check our website www.billstruckshop.com for California trucks and parts

Bill's Truck Shop

Phone (905) 725-3460 / (905) 725-2022 / Fax (905) 404-2302 email: bill@billstruckshop.com

Glass & Trim

Due to the fluctuation of the Canadian and American dollars call for current prices

Group 15

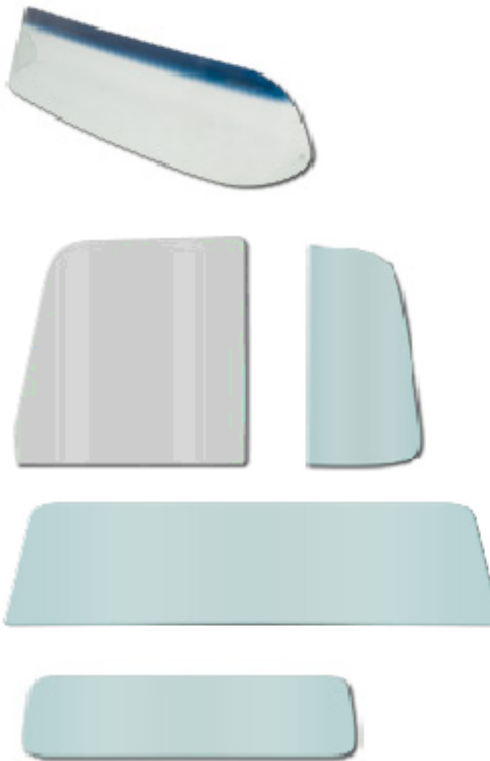

Front glass are laminated / rear and side glass are tempered all glass DOT approved

Year

New

Windshield

15-301-C	clear (special order-10 days)		55-59	\$449.95
15-301	tinted only -NO upper shade		55-59	\$449.95
15-301-T	tinted w/ shaded top		55-59	\$449.95

Door Glass-----requires seal # 13-312-S to install in sash

15-303-C	clear	each	55-59	\$63.95
15-303-T	green tint	each	55-59	\$63.95
15-303-G	gray tint		55-59	\$63.95

Vent Glass

15-305-C	clear		55-59	\$49.95
15-305-T	green tinted		55-59	\$52.95
15-305-G	gray tint		55-59	\$54.95

Uses 1-0GST-1 on vent glass install

Back Glass

15-306-SC	small clear		55-59	\$119.95
15-306-ST	small tinted		55-59	\$124.95
15-306-SG	small gray tint		55-59	\$129.95
15-306-LC	large clear		55-59	\$399.95
15-306-LT	large tinted		55-59	\$469.95
15-306-LG	large grey tinted		55-59	\$424.95

Rear Barn Door Glass-panel/suburban

15-307-CL	clear/left		55-59	\$64.95
15-307-CR	clear/right		55-59	\$64.95
15-307-TL	green tint/right		55-59	\$144.00
15-307-TR	green tint/right		55-59	\$144.00

Rear Hatch Glass

15-308-C	clear		55-59	Inquire
15-308-T	green tint		55-59	Inquire

Bill's Truck Shop

Phone (905) 725-3460 / (905) 725-2022 / Fax (905) 404-2302 email: bill@billstruckshop.com

Glass & Trim

Due to the fluctuation of the Canadian and American dollars call for current prices

Group 15

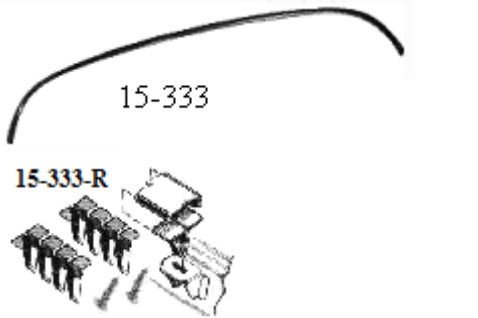

Windshield Dash Trim -lower

	<u>Year</u>	<u>New</u>	<u>Used</u>
15-333	55-59	\$109.95	\$60.00

Windshield Dash Trim Retainer set

15-333-R	w/ screws	55-59	\$15.95
----------	-----------	-------	---------

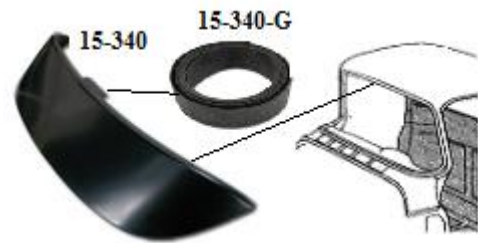

Outside Sun visor

15-340	steel w/hardware	55-59	\$249.95
--------	------------------	-------	----------

15-340-G	roof to visor gasket	55-59	\$10.95
----------	----------------------	-------	---------



Windshield Trim

inquire on individual used pieces

24-304-F	stainless trim in front glass seal - set	55-59	\$229.95
----------	--	-------	----------

24-304-J	stainless jointers for glass trim - each	55-59	\$3.95
----------	--	-------	--------

Bill's Truck Shop

Phone (905) 725-3460 / (905) 725-2022 / Fax (905) 404-2302 email: bill@billstruckshop.com

Lights Lamps Lens

Due to the fluctuation of the Canadian and American dollars call for current prices

Group 16

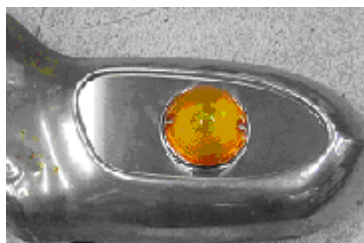
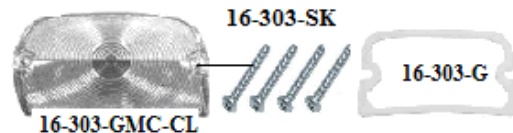

16-0428

Parklamp Lens

			Year	New	Used
16-303-GMC-CL	GMC clear-	left	55-57	\$29.95	
16-303-GMC-CR	GMC clear-	right	55-57	\$29.95	

Parklamp Lens Gasket (pair)

16-303-G	GMC - pair		55-57	\$13.95	
----------	------------	--	-------	---------	--

16-304-GMC-K 58-59 GMC park light kit -
Replace the OE style glass lens w/-brushed stainless steel inserts and **ADD** either **amber** or **clear** park light assemblies (16-301-HC or 16-301-HA)
 pair 58-59 \$93.00

Park lamp Housing Assembly w/ harness & lens

16-301-HC	Chev/ with clear lens	- each	55-57	\$49.95	
16-301-HA	Chev/ with amber lens	- each	55-57	\$49.95	
16-303-SK	4 stainless screws----	GMC	55-57	\$2.95	

Park lamp Housing Assembly w/ harness & lens

16-303-HA	GMC	-each	55-57		
16-304-L	OE assembly	left	58-59	\$324.95	
16-304-R	OE assembly	m right	58.-9	\$324.95	
16-304-HA	GMC	-each	58-59		Inquire

\$30.00

Socket-signal & brake

16-0428	2 wire for signal-brake & running light- accepts 2 pin 1157 bulb	each		\$7.95	
---------	--	------	--	--------	--

Bill's Truck Shop

Phone (905) 725-3460 / (905) 725-2022 / Fax (905) 404-2302 email: bill@billstruckshop.com



			<u>Year</u>	<u>New</u>	<u>Used</u>
Parklamp Lens					
16-301-C	Chev clear-	each	55-57	\$8.95	
16-301-A	Chev amber	each	55-57	\$8.95	
16-302-C	Chev clear	each	58-59	\$7.95	
16-302-A	Chev amber-	each	58-59	\$8.95	
Park lamp Screw set					
16-302-SK	4 stainless screws --Chev		58-59	\$2.25	
Park lamp Housing Assembly w/ harness & lens					
16-301-HC	Chev/ with clear lens	- each	55-57	\$49.95	
16-301-HA	Chev/ with amber lens	- each	55-57	\$49.95	
16-302-HC	Chev /with clear lens	-each	58-59	\$89.95	
16-302-HA	Chev/ with amber lens	-each	58-59	\$89.95	
Parklamp Lens Gasket (pair)					
16-301-G		Chev - pair	55-57	\$2.95	
16-302-G		Chev - pair	58-59	\$4.95	
Park lamp Housing to Fender Gasket					
16-301	Chev	pair	55-57	\$5.95	
Park lamp Bezel					
16-302-B	Chev chrome L or R	each	58-59	\$76.95	\$30.00
Park lamp Harness Grommet					
16-305-G	1 each side of rad support	pair	55-59	\$5.95	
Socket-signal & brake					
16-0428	2 wire for signal-brake & running light- accepts 2 pin 1157 bulb	each		\$7.95	

Bill's Truck Shop

Phone (905) 725-3460 / (905) 725-2022 / Fax (905) 404-2302 email: bill@billstruckshop.com



		<u>Year</u>	<u>New</u>	<u>Used</u>
Headlamps				
16-0206-12	12 volt Halogen		\$22.95	\$10.00
16-05001H	GMC high (inner) Halogen each	58-72 GM 60-62 Che	\$21.00	
16-05006H	GMC high/low (outer) Halogen each	58-72 GM 60-62 Che	\$20.95	
Headlight Bezel Screws= stainless steel				
16-355-S		6 pcs 55-57	\$2.50	
16-358-S		8 pcs 58-59	\$2.95	
Headlamp Bezel Seals w/ wire core as original				
16-0207-1		pair 47-57	\$15.95	
Headlamp Bulb Retainer Ring-				
16-3HR	stainless steel w/o hold down ears	55-57	\$21.95	
19-0HR-2	58-61 Chev & 58-64 GMC w/ 2 retainer tabs each	58-64	\$11.95	
Headlamp Bulb Retainer Ring Screws				
12-0HRS-6		47-87	\$2.95	
Headlamp Adjusting Screws and Nut				
16-0207-A	1 screw w/ threaded nylon nut	47-57	\$4.95	
16-0432	1 adjuster w/hdw	58-61	\$2.95	
Headlamp Adjuster Spring w/ hdw				
16-0207-S	each w/ hdw	47-59	\$4.95	
Headlight Ring Support/Post				
16-0208	secures to light pot lower w/ hdw	each 47-57	\$8.95	
Headlamp Bucket to Fender Gaskets				
16-0515		pair 47-57	\$8.95	
16-315-58	black sealer/caulking strips	set 58-59	\$12.95	

Bill's Truck Shop

Phone (905) 725-3460 / (905) 725-2022 / Fax (905) 404-2302 email: bill@billstruckshop.com

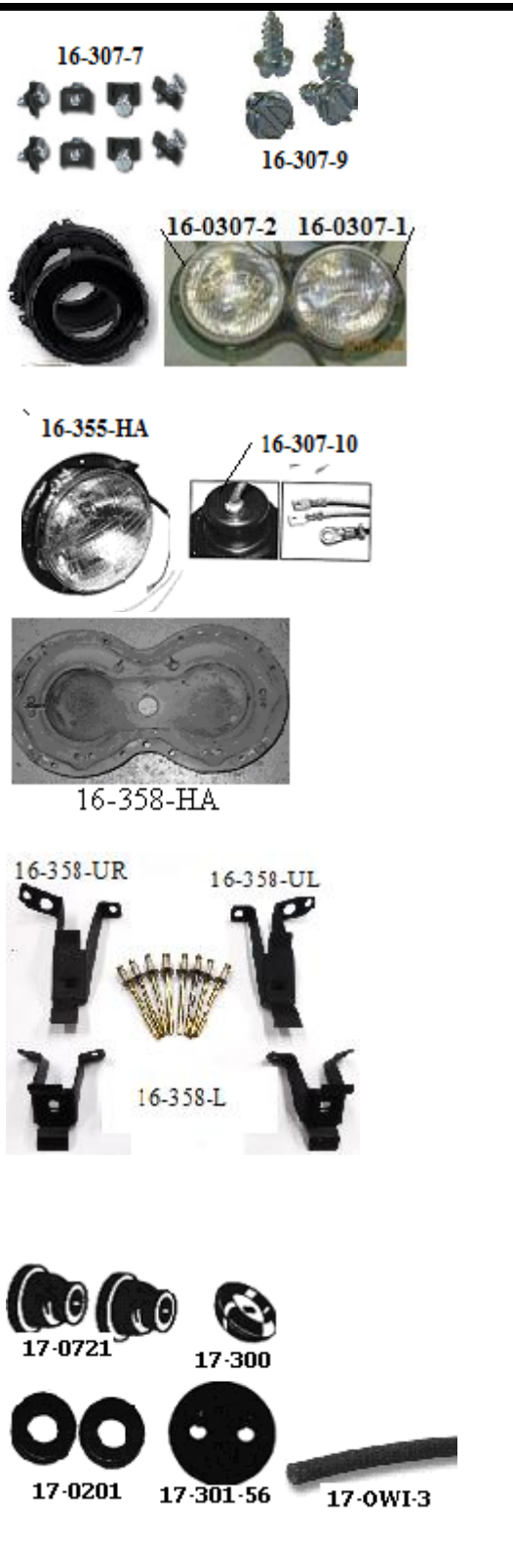

			<u>Year</u>	<u>New</u>	<u>Used</u>
Headlamp Bucket to Fender mount kit					
16-307-7	screws w/ j nuts	16pcs	55-57	\$10.95	
16-307-9	screws only	14pcs	58-59	\$4.95	
Headlamp Cup for head light					
16-307-10	w/ guide tab w/ o screw holes to secure light retainer Chev	each	55-57		\$20.00
The following "cups" fit 58-61 Chev and 58-66 GMC -includes retainer ring					
16-0307-1	outer / left -drivers side		58-66	\$42.95	
16-0307-2	inner / left- drivers side		58-66	\$42.95	
16-0307-3	outer / right - pass side		58-66	\$42.95	
16-0307-4	inner / right - pass side		58-66	\$42.95	
Note-cups are stamped w/ "1 for inside and "2 for outside w/ L for left and R for right -headlight must sit vertical					
16-0307-K	4 cups w/ rings		58-62	\$159.95	
Headlamp Bucket Assembly-					
16-355-HA	w/ universal harness w/o bulb -each		55-57	\$99.95	
16-355-HAB	w/ OE style harness, hdw & 12V seal beam		55-57	\$189.95	
16-358-HA	w/ light ring/harness / light pot -each		58-59	Coming	
Headlamp Bezel Stands—w/ rivets--sold as each -up R is the in on L///// up L is the in R					
16-358-UL	upper bezel stand---outer R/ inner L		58-59	\$9.95	
16-358-UR	upper bezel stand-inner right/outer R		58-59	\$9.95	
16-358-L	lower bezel stand		58-59	\$6.95	
16-358-K	4 pc kit w/ hdw for 1 side		58-59	\$34.95	
Headlamp Bucket Wire Grommets					
17-0721		pair	47-57	\$5.95	
17-300	one per housing	pair	58-59	\$18.95	
Headlight Wiring Inner Fender Grommet					
17-0201	hole diameter 3/4 "	pair	47early56	\$3.25	
17-301-56	hole size 1 3/8 w/ 2 hole grommet	each	late 56-57	\$2.95	
17-301-58	single 15/16 hole in inner fender -	pair	58-59	\$2.50	
Headlight Wiring Loom Black fabric over wire as original					
18-0WL-1	1/4 ID	per foot		\$1.50	
18-0WL-3	3/8 ID	per foot		\$1.70	
18-0WL-5	1/2 ID	per foot		\$1.95	

Bill's Truck Shop

Phone (905) 725-3460 / (905) 725-2022 / Fax (905) 404-2302 email: bill@billstruckshop.com

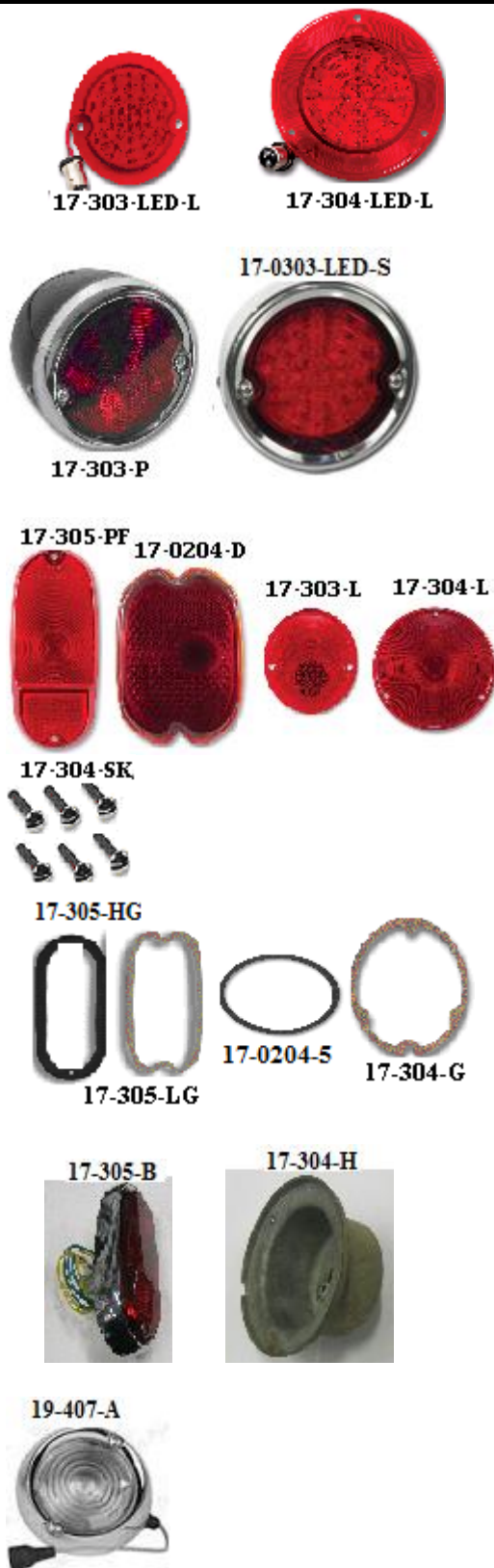

			<u>Year</u>	<u>New</u>	<u>Used</u>
Tail lamp Assembly with Wiring –stepside					
17-303-P	painting w/ stainless steel bezel	each	55-59	\$68.95	
17-303-S	stainless steel	each	55-59	\$79.95	
Tail lamp Assembly w/ LED lightning					
17-0303-LED-S	stepside stainless steel housing w/wiring - each		54-59	\$99.95	
17-0303-LED-P	stepside-black w/ housing w/ wiring each		54-59	\$89.95	
Tail Lamp Lens—LED includes harness w/ socket					
17-304-LED-L	fleetside-LED lens fits OE housing-each		58-59	\$64.95	
17-303-LED-L	stepside LED lens fits OE housing - each		55-59	\$69.95	
17-303-L	stepside	each	55-59	\$6.95	
17-304-L	fleetside	each	58-59	\$9.95	
Tail Lamp Lens Screw kit-if holes are enlarged insert some wire for screws to tighten					
17-304-SK	stainless steel-fleetside	6 pcs	58-59	\$2.00	
17-305-SK	stainless steel-panel #8-32	4 pcs	56-59	\$1.00	
Tail Lamp Lens—Panel or Suburban					
17-0204-D	oval red w /barn doors only		47-56	\$21.95	
17-305-PF	plastic on fender	each	55-59	\$22.95	
17-0204-C	round red w/ clam shell doors only		47-59	inquire	
Tail lamp Lens Gasket					
17-0204-5	stepside	pair	55-59	\$3.95	
17-304-G	fleetside	pair	58-59	\$8.95	
17-0204-6	subur/ panel truck w/oval lens w/ taillight on rear door w/ side by side doors only		47-56	\$4.60	
17-305-LG	suburban/panel w/ lights on ¼ panel	pair	55-59	\$6.95	
Taillamp Body Mount Gasket – rubber					
17-305-HG	suburban/panel w/ lights on ¼ panel	pair	55-59	\$12.50	
Taillight Assembly suburban/panel on ¼ panel					
17-305-B	chrome housing w/ plastic lens & stub harness left & right are the same –rotate lens for other side	each	56-59	\$119.95	
Taillight Housing					
17-304-H	fleetside	each	58-59	\$59.95	
Reverse Light Assembly can install 60-66 rev light assembly on 58-59 fleet side box below brake light					
19-407-A	reverse light assembly	each	60-66	\$89.95	



Tail lamp Bezel

			Year	New	Used
17-303-B	stainless steel –stepside	each	55-59	\$10.95	
17-304-B	aluminium – fleetside	each	58-59	\$23.95	
17-0205-2	chrome sub/panel truck w/oval lens w/ side by side doors only		47-56	\$33.95	

17-0205-C w/ clam shell doors only-round 47-59 inquire

Tail lamp Wire Conduit / stainless steel

17-0208	18 in long	pair		\$19.95	
---------	------------	------	--	---------	--

Taillamp Wire Grommet

17-0208-G		pair	47-72	\$2.75	
-----------	--	------	-------	--------	--

Blue dot w/chrome bezel (pair)

17-0209-P	Plastic	pair		\$11.95	
-----------	---------	------	--	---------	--

Taillamp Bracket

Painted

17-0510-BL			55-66	\$10.95	
------------	--	--	-------	---------	--

17-0510-BR			55-66	\$10.95	
------------	--	--	-------	---------	--

Chrome

17-0510-CR			55-66	\$18.95	
------------	--	--	-------	---------	--

17-0510-CL			55-66	\$18.95	
------------	--	--	-------	---------	--

Taillight Bk Bolt kit

17-0510-KA	philips drive w/ washer-stainless steel	8 pc kit	54-72	\$7.95	
------------	---	----------	-------	--------	--

17-0510-KB	7/16 hex head w/ washer-stainless steel	8 pc kit	54-72	\$7.95	
------------	---	----------	-------	--------	--

Taillamp Assembly w/ plate bracket-mounts on left rear door on panel, suburban—side by side doors only

17-0206			47-56	\$150.00	
---------	--	--	-------	----------	--

17-0205-C	w/ clam shell doors only-folds out when lower gate opens-		47-59	\$200.00	
-----------	---	--	-------	----------	--

Taillamp Assembly Mount Pad-between light housing and bracket

17-0206-P	moulded rubber pad		47-56	\$69.95	
-----------	--------------------	--	-------	---------	--

Taillamp Harness Grommet- w/ side by side doors

17-0206-G	in door behind housing		47-56	\$2.50	
-----------	------------------------	--	-------	--------	--

License Light Lens

17-0206-L			47-56	\$39.95	
-----------	--	--	-------	---------	--

License Lens Gasket - w/ side by side doors

17-0206-LG			47-56	\$1.55	
------------	--	--	-------	--------	--

Hood Light Kit

15-0HL	OE accessory kit		47-72	\$69.95	
--------	------------------	--	-------	---------	--

Bill's Truck Shop

Phone (905) 725-3460 / (905) 725-2022 / Fax (905) 404-2302 email: bill@billstruckshop.com

		<u>Year</u>	<u>New</u>	<u>Used</u>
License Plate Bracket & Lamp Assembly				
18-303-S	stepside –secures to rear cross sill	54-59	\$59.95	
18-0303-F	fleetside-mounts to bumper	58-66	\$69.95	
18-0812	plate bkt bolts- stainless capped bolt @ bumper pair	58-66	\$9.95	
18-0303-L	plate light lens-glass	58-66	\$9.95	
18-0303-G	plate light lens- gasket	58-66	\$1.50	
18-0303-U	mount @ rear cross sill w/ no rear bumper	54-87	\$19.65	
18-0389	bulb-plate light-single contact-level pins 12V 6 CP each		\$1.95	
Wire Harness Clips				
18-0205-S	for sheet metal	each 47-72	\$1.95	
18-0205-OE	OE style frame harness clip	each 41-59	\$3.79	
18-0205-F	at frame locations	each 47-72	\$1.50	
37-0315	insulated clamp style w/ hdw	pair	\$2.00	
18-0205-P	OE plastic LOOP style found on GMC pickups at inner fenders	set of 4 55-62	\$7.50	
18-0205-B	OE brass tie straps used to secure wiring harness and washer hose under the dash and engine bay	pair 55-62	\$9.95	
Wiring Loom black fabric as original				
18-0WL-1	¼ in diameter.	Per foot	\$1.10	
18-0WL-3	3/8 in diameter	Per foot	\$1.35	
Wiring Conduit –plastic, black, ribbed, split wiring covering				
18-0WC-1	¼ in dia	Per foot	\$0.60	
18-0WC-3	3/8 in dia	Per foot	\$1.00	
18-0WC-5	½ in dia	Per foot	\$1.10	
Wiring Plug w/ grommet @ connectors				
18-0547	universal 8 plug pass through connector kit		\$22.95	

Bill's Truck Shop

Phone (905) 725-3460 / (905) 725-2022 / Fax (905) 404-2302 email: bill@billstruckshop.com

WIRING HARNESS

Due to the fluctuation of the Canadian and American dollars call for current prices

Group 18

17-0208-B



Wiring Harness –PVC coated copper wiring in the correct colour code to replace the original wiring. Complete front to rear W/ detailed instructions. 6 or 8 cyl-
Gen harness to use with Original system & **Alt** w/ internal regulator type –NOT a direct fit for GMC some modifications required for GMC-**fleetside require 2 x 17-0208-B**

		<u>Year</u>	<u>New</u>	<u>Used</u>
18-304-G	w/ generator	55-59	\$499.95	
18-304-A	w/ alternator	55-59	\$499.95	

Taillamp Socket w/ Wire & Rubber Boot

17-0208-B	taillights	each	47-66	\$8.95
-----------	------------	------	-------	--------

Custom Classic Updated Wiring Harness kit- by American Autowire

An excellent replacement updated wiring harness w/ blade type 18 fuse –21 circuit –includes plugs, switches for original or aftermarket gauges-HEI or point type dist harness- column connectors for stock or updated columns-front, rear & dome, under dash light harness-updates for original or AC updates, power windows, seats, stereo, electric fuel pumps etc-includes complete instructions, grommets, connectors, fuses, flasher extra wiring ties

18-3481			55-59	\$1224.95
---------	--	--	-------	-----------

Fuse Block

18-305	w/ primary wiring & instructions		55-59	\$69.95
--------	----------------------------------	--	-------	---------

When adding electric wipers and using w/ fuse panel- power can also be supplied through AC fuse terminal OR ignition switch w/ pre-fused wipers

Fuses----- all acc fuse panel fuses are 1/4 x 7/8 long AGW glass fuses

AG Fuses Originally stood for “all glass.” The automotive industry uses the “AG” prefix (AGC, AGW) for most glass fuses. They vary in length, diameter and amperage rating.

18-0674-25	25 amp	each		\$0.99
18-0673-20	20 amp	each		\$0.99
18-0671-10	10 amp	each		\$0.99
18-0670-5	5 amp	each		\$0.99

Accessory fuse panel

18-0023	6 pin/uses ATO spade fuses			\$49.95
---------	----------------------------	--	--	---------

Fusible Link

18-0832 9 “ 12 gauge slow burn wire- fuse wire is usually 4 gauges smaller then circuit wire w/ connectors-excellent safety precaution installed to ignition feed wire at starter approx. 20-25 amps---add to starter-ignition dash feed

\$3.50

Bill's Truck Shop

Phone (905) 725-3460 / (905) 725-2022 / Fax (905) 404-2302 email: bill@billstruckshop.com

WIRING HARNESS

Due to the fluctuation of the Canadian and American dollars call for current prices

Group 18

		<u>Year</u>	<u>New</u>	<u>Used</u>
All apply to OE application-CHEV----- special order only -will quote cost at time of order				
Headlamp Harness –lamps to connector-pr				
18-307-55H		55-57	\$49.95	
18-307-58H		58-59	\$49.95	
Socket-headlamp harness repair				
16-0001	3 wire	each	\$3.95	
Front light harness				
18-3350	6 cyl w/ stock generator	12 volt	55-55	Inquire
18-3035	V8 w/stock generator	12 volt	55-55	Inquire
18-3415	V8 w/stock generator		56-56	Inquire
18-3400	6 cyl w/stock generator		56-56	Inquire
18-3045	6 cyl w/ stock generator & signals		56-56	Inquire
18-3030	V8 w/stock generator & signals		56-56	Inquire
18-3555	w/ stock generator		57-57	Inquire
18-3040	w/stock generator & signals		57-57	Inquire
18-3860	w/ stock HD generator		57-57	Inquire
18-3805	w/stock HD generator		58-58	Inquire
18-3715	w/stock generator		59-59	Inquire
18-3055	w/ stock generator & signals		58-59	Inquire
Rear Body Harness				
18-3158	Cameo only		55-55	Inquire
18-3370	w/ brake, tail & signal lights		55-55	Inquire
18-3155	extension w/ long bed/pair		55-59	\$31.95
18-3164	Cameo only		56-56	Inquire
18-3350-A	w/ brake, tail & signal lights			\$33.95
requires #18-3155	w/ long bed		56-56	
18-3166	Cameo only		57-58	Inquire
18-3150	w/ brake, tail & signal lights-			\$151.95
requires #18-3155	w/ long bed		57-59	
Grommet-@ rear frame crossmembers				
18-310-G	protects harness to rear	each	55-59	\$3.25
Transmission Overdrive				
18-3280	w/ V8		55-56	Inquire
18-3545	w/ V8		57-57	Inquire
Turn Signal Harness				
18-3365	dash side		55-55	Inquire
18-3430	engine side		55-55	Inquire
18-3360	dash side		56-56	Inquire
18-3570	engine side		56-56	Inquire
18-3355	dash side		57-59	Inquire

Bill's Truck Shop

Phone (905) 725-3460 / (905) 725-2022 / Fax (905) 404-2302 email: bill@billstruckshop.com

All apply to OE application-CHEV----- special order only -will quote cost at time of order

Engine / Starter Harness-all w/ generator			
18-3400-A	6 cyl w/ auto trans 12 V	55-55	Inquire
18-3395	6 cyl w/ manual trans 12 V	55-55	Inquire
18-3285	8 cyl w/ auto trans 12 V	55-55	Inquire
18-3385	8 cyl w/ manual trans 12 V	55-56	Inquire
18-3290	V8 w/auto trans & HEI	55-56	Inquire
18-3295	V8 w/manual trans & HEI	56-56	Inquire
18-3395-A	6 cyl w/ auto trans	56-56	Inquire
18-3390	6 cyl w/ manual trans	56-56	Inquire
18-3405	V8 w/auto trans	56-56	Inquire
18-3425	V8 w/ manual trans	57-57	Inquire
18-3570-A	6 cyl w/ auto trans	57-57	Inquire
18-3550	6 cyl w/ manual trans	57-57	Inquire
18-3560	V8 w/ auto trans	57-57	Inquire
18-3565	V8 w/ manual trans	57-59	Inquire
18-3310	V8 w/ auto trans & HEI	57-59	Inquire
18-3315	V8 w/ manual trans & HEI	58-59	Inquire
18-3910	6 cyl w/ auto trans	58-59	Inquire
18-3905	6 cyl w/ manual trans	58-59	Inquire
18-3735	V8 w/ auto trans	58-59	Inquire
18-3810	V8 w/ manual trans	58-59	Inquire
18-3790	V8 w/ manual & over speed governor light		Inquire

Dash Harness

18-3465	w/ 12 volt	55-56	Inquire
18-3750		57-59	Inquire

Under Hood Lamp---early 1960 GM reproduction option

15-0HL			\$69.95
--------	--	--	---------

Bill's Truck Shop

Phone (905) 725-3460 / (905) 725-2022 / Fax (905) 404-2302 email: bill@billstruckshop.com

			<u>Year</u>	<u>New</u>	<u>Used</u>
Headlamp Switch					
18-307	OE style w/ fuse NO rod & knob		55-59	\$62.95	
18-0332	must be used when adding halogen lights to carry increased amp load –includes “3 sided” shaped rod, aluminum knob and retainer –can use #36-309 radio knob to match other dash knobs		47-59	\$49.95	
18-207-12U	Headlight Switch-12V universal application w/rod & chrome knob --screw on pins		47-59	\$37.95	
Headlamp Switch Retainer/Bezel					
5-303-B			55-59	\$15.95	
Light Knob and Rod					
5-303	Chev w/ chrome knob		55-59	\$14.95	\$5.00
5-303-W	GMC w/ white knob		55-59		\$15.00
Terminal Block-secures to rad support on GMC truck					
17-303-3	3 pin w/o signals lights	each	55-59	\$16.95	
17-303-4	4 pin w/ signals lights	each	55-59	\$16.95	
19-0131					
Breaker less Ignition system for V8 GM dist-never change point again-uses a Hall Effect magnetic			56-74	\$245.00	

Bill's Truck Shop

Phone (905) 725-3460 / (905) 725-2022 / Fax (905) 404-2302 email: bill@billstruckshop.com

Electrical

Due to the fluctuation of the Canadian and American dollars call for current prices

Group 18

		<u>Year</u>	<u>New</u>	<u>Used</u>
Dimmer Switch w/ screws				
18-308-55	push on staggard terminal	55-56	\$28.95	
18-308-57	push on pins-"T" position	57-60	\$24.95	
Dimmer switch -screw kit				
18-0305	2 pcs	39-61	\$1.00	
Horn Relay				
18-0209	6 or 12 V w/ screw on terminals	41-56	\$34.95	
18-0309-57	push on terminals	57-62	\$39.95	
Horn				
18-0210-6	6 volt inquire about original horns			
Chev OR GMC	high or low tone	55-59		\$50.00
14-042-H	12V high tone -universal	47-87	\$21.95	
14-042-L	12V low tone - universal	47-87	\$21.95	
Turn signal Switch Assembly				
18-0551-U	universal column mount w/4-way& instructions-requires 3 pin flasher	47-59	\$52.95	
Note-----54-56 signal bowl signal lever exits straight out and 58-59 comes out on upper angle				
18-0211	in upper bowl-has loose harness connectors	55-56	\$36.95	
18-311-57	in upper bowl w/ plug adaptor for harness	57-59	\$39.95	
Turn signal Wire Connector (For # 18-311-S)				
18-0211-1		54-59	\$2.25	
Turnsignal Housing Assembly w/ signal switch- does not include signal lever # 5-305-1				
18-0311-54H	original cup type on column	54-56	\$199.95	
18-311-57H	original cup type on column	57-59	\$199.95	
Turn Signal Housing Wedge				
18-0211-W	locks signal bowl to column	54-59	\$3.75	
Signal Flasher Plug and Harness & Bracket				
18-213-P			\$39.95	
Turn signal Flasher				
18-0213-F6	6 volt 3 pin		\$26.75	
18-0213-F12-L	12 volt 3 pin-use w/ LED lights		\$21.95	
18-0213-F12-L2	12 volt 2 pin-use w/ LED lights		\$22.50	
18-0213-F12	12 volt 3 pin		\$24.95	
14-0SF-12	12 volt 2 pin		\$9.95	
14-0SF-12HD	12 volt HD electronic		\$14.95	
Turn signal Switch Cancel Plate				
18-0214	Cancel original type turn signals.	54-59	\$5.60	
Turn signal Switch Cancel Plate install kit				
18-0214-HK	2 screws w/ washers	54-66	\$1.25	

Bill's Truck Shop

Phone (905) 725-3460 / (905) 725-2022 / Fax (905) 404-2302 email: bill@billstruckshop.com

Ignition Switch w/o keys

18-301-55F	off & on position only for foot start	55-59	Inquire
18-301-55	V8/ key start—will accept 18-013 & 18-013-B cyl & key double release hole	55-56	\$79.95
18-301-57	V8 key start- will accept 18-013 & 18-013-B double release hole	57-59	\$59.95
18-0632	universal type- w/ aluminium retainer -5 pin w/ 4 position - key start —includes instructions	55-66	\$49.95
18-0670	universal type- w/ aluminium retainer -5 pin w/ 4 position - key start —includes instructions , harness plug w/ connectors ---accepts OE indicator dial---does not include keys	55-59	\$59.95

Ignition Switch Harness

18-3444	Adapts the 57-59 OE harness to the 55-56 repro ignition switch	57-59	
---------	--	-------	--

Ignition Cylinder w/OE Style Keys

18-013	single hole for spring pi entry	47-66	\$21.95
18-013-B	extension allows for vehicle to be started w/o keys if not placed in lock position-also need keys to place in lock position- w/ 2 keys---2 hole for spring pin entry	47-66	\$25.95

Key-blank GM key

18-013-	BLANK ignition-door-glovebox	47-66	\$8.95
---------	------------------------------	-------	--------

Ignition Indicator Dial

18-301-D	w/ v8	55-59	\$12.95
----------	-------	-------	---------

Ignition Switch Bezel

18-301-OE	original style w/larger 1 9/16 outer dia	55-59	\$10.00
18-301-B	1 3/8 outer dia	55-59	\$17.95

Starter Switch – at starter

18-0202-ST	w/ side terminal for 12 v ignition feed	38-59	\$35.95
18-0202	w/ out side terminal	38-59	\$25.95

Push Button Start Switch

18-0TB2	dash mount push button start switch-w/ aut trans or electric start solenoid 15A@12V 5/8 shaft dia		\$19.95
---------	---	--	---------

Brake Light Switch w/ screws

18-304		55-59	\$11.95
--------	--	-------	---------

Brake Switch Screw kit

18-0217	pair	42-59	\$1.00
---------	------	-------	--------

Upper Column Bearing w/ Horn Wire

18-0311		47-59	\$84.95	\$30.00
---------	--	-------	---------	---------

Horn Wire Cover @ lower column

18-0211-C		47-59	\$10.00
-----------	--	-------	---------

Bill's Truck Shop

Phone (905) 725-3460 / (905) 725-2022 / Fax (905) 404-2302 email: bill@billstruckshop.com

		<u>Year</u>	<u>New</u>	<u>Used</u>
Dash Bulb Socket				
18-0DB-S	USED OE metal socket w/ NEW harness	47-66		\$9.95
18-0DB-SN	new plastic replacement socket w/ ,6" wire	47-66		\$4.95
Dash Bulb-wiring-to replace dash bulb wiring when insulation is broken away using your original metal socket				
18-0DB-W		47-66		\$1.75
Dash Bulb				
18-0HB-6v	smaller 7/16 head for high beam indicator			\$2.15
18-0HB-12V	smaller 7/16 head for high beam indicator			\$1.20
18-0DB-6V	6 volt			\$2.25
18-0DB-12v	12 volt			\$1.50
Brake – Signal Light Bulbs				
19-0179A	amber / 3 CP	12 volts		\$2.25
19-0179	clear / 3 CP	12 volts		\$1.25
Temp Sender				
19-0469	6 or 8 Cyl—1/2 x 14 NPT w/ gauges	56-72		\$26.95
Dimmer Switch Plug				
3-0DS-P	3 pin plug w/ connectors	57-83		
Fuses-barrel style 1 ¼ long				
18-0003	3 amp			\$0.50
18-0004	4 amp			\$0.50
18-0005	5 amp			\$0.50
18-0010	10 amp			\$0.50
18-0015	15 amp			\$0.50
18-0020	20 amp			\$0.50
Ground Strap-tin coated copper wire				
18-0170-8	8" 11 gauge w/ 3/8 eyelets			\$12.95
Fuse Holder-accessory				
18-0987	sealed w/ hdw & fuse- note fuse size			\$5.95
Horn Button-column mount				
18-0018	6 or 12V application			\$9.50
Voltage Regulator w/ generator				
Voltage Regulator				
18-0210-12-25	12 volt w/ 25 amp gen	47-62		\$69.95
18-0210-12-35	12 volt w/ 35 amp gen	47-62		\$69.95



19-0469



3-0DS-P

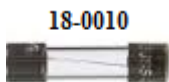

18-0010



18-0018



18-0987



18-0170-8



18-0210-12-25

	<u>Year</u>	<u>New</u>	<u>Used</u>
Tailgate w/ handle openings			
19-3555-T	55-58	\$799.95	
Tailgate Cover – fibreglass			
19-3555-TC	55-58	Inquire	
Tailgate Recoilers			
32-0105-R Cameo gate or lift gates on Suburban each --flat band/not cable	47-59	\$114.95	
Tailgate Handles-pr			
Tailgate Latch w/ handle			
19-3555-LL left side	55-58	Inquire	
19-3555-RL right side	55-58	Inquire	
Tailgate Handle-pr			
19-3555-H chrome	55-58	\$199.95	
Tailgate Ear- for latch striker			
19-3555-E L & R same each	55-58	\$34.95	
Tailgate Cable- multi-strand cable w/ crimped ball ends and recoiler bkt			
19-3555-C pair	55-58	\$199.95	

19-3555-LL



19-3555-C



19-3555-H



	<u>Year</u>	<u>New</u>	<u>Used</u>
Spare Tire Carrier-fibreglass			
19-3556	55-58	Inquire	
Spare Tire Carrier Bolts			
19-3556-B polishes stainless steel bolts for hinged center bumper section	55-58	Inquire	
Spare Tire Carrier Supports			
19-3556-S pair	55-58	\$95.00	
Spare Tire Carrier Hinge			
19-3556-H	55-58	\$79.95	
Spare Tire Channel Support			
19-3556-CS	55-58	NLA	
Spare Tire Carrier Seal			
19-3556-SC around edge of fibreglass tub	55-58	\$15.95	
Spare Tire Inner Bumper Pan			
19-3556-P	55-58	Inquire	
Spare Tire Clamp			
19-3556-C	55-58	\$34.95	
Spare Tire Bracket Assembly			
19-3556-BA	55-58	\$36.95	



19-3556-P

19-3556-CS



19-3556-C





19-3554-T

19-3554-TS



19-3555-RC



19-3758-C



19-3555-TU

19-3555-TM

19-3555-T



19-3555-T

19-3555-T

Bedside Letters- C A M E O

19-3758-C chromed/polished letters-set 57-58 Inquire

Taillight Trim- u-shaped trim below taillight-2 pc per side-smooth finish to chrome or paint

19-3760-L left -pair 57-58 Inquire

19-3760-R right -pair 57-58 Inquire

Bedside Upper Mld-pr

19-3554-T 55-58 Inquire

Bedside Upper Mld Screw kit

19-3554-TS 55-58 Inquire

Bed front side mld are made from billet aluminum and polished-sold as pairs only

All Special Order

Bed Front Upper trim-pr

19-3555-TU 55-58 Inquire

Bed Front Middle Trim-pr

19-3555-TM 55-58 Inquire

Bed Front Lower Trim-pr

19-3555-TL 55-58 Inquire



19-3540-R

Bedsides-fibreglass outer skins

	<u>Year</u>	<u>New</u>	<u>Used</u>
19-3540-L	55-58	\$858.00	
19-3540-R	55-58	\$858.00	

19-3542-R 19-3542-F



Filler panel –bedside front/fibreglass

19-3541-L	left	55-58	\$149.00
19-3541-R	right	55-58	\$149.00

19-3541-L



Bedside Supports-secures the fibreglass sides to prevent vibration-rear is shorter then ft made in Canada

19-3542-F	front left or right	each	55-58	\$22.95
19-3542-R	rear left or right	each	55-58	\$22.95



BTS
EXCLUSIVE

Braces-bed side	set 5 per side			
19-3543-B	fits L & R	55-58	\$174.95	

19-3543-B



Original style **made w/ 16 gauge steel**
28-0354-T Cameo-Carryall(GMC) and
stepside

54-59	\$169.95
-------	----------



28-0354-T

Rear Cross Sill predrilled w/ support brackets
30-3715-T Cameo-Carryall(GMC) and
stepside

55-59	\$199.95
-------	----------



30-3715-T

Bill's Truck Shop

Phone (905) 725-3460 / (905) 725-2022 / Fax (905) 404-2302 email: bill@billstruckshop.com



Bedsides-inner

			<u>Year</u>	<u>New</u>	<u>Used</u>
31-3397	Cameo / Suburban	left	55-58		Inquire
31-3384	Cameo / Suburban	right	55-58		Inquire
31-3557	Cameo/Suburban w/o stake pocket holes	left	55-58		Inquire
31-3558	Cameo/Suburban w/o stake pocket holes	left	55-58		Inquire

17-303-CR



17-303-CP



19-3155-BK



17-303-CG



Taillight Lens Gasket

17-303-CG		pair	55-58		\$9.95
-----------	--	------	-------	--	--------

Taillight Lens

17-303-C	plastic	each	55-58		\$9.95
----------	---------	------	-------	--	--------

Tail lamp Reflector

17-303-CR	tail lamp lens centre reflector	each	55-58		\$23.95
-----------	---------------------------------	------	-------	--	---------

Backup Lens

17-303-CB	reverse lens-plastic	each	55-58		\$9.95
-----------	----------------------	------	-------	--	--------

License Plate Light kit-pr

17-303-CP	housing-lens-wiring		55-58		\$49.95
-----------	---------------------	--	-------	--	---------



17-303-C



17-303-CR



17-303-CB



24-315-E

Cameo Inner Bumpers

19-3155-IB		pair	55-58	Inquire	Inquire
------------	--	------	-------	---------	---------

Cameo Bumper Ends triple nickel plated chrome

19-3155-E		pair	55-58	Inquire	Inquire
-----------	--	------	-------	---------	---------

Cameo -rear bumper bkt set

19-3155-BK		set	55-58		Inquire
------------	--	-----	-------	--	---------



19-3155-IB



19-3255-WC

Trim Ring Clip

19-3255-WC	metal clip w/ correct rubber bumper - 5 required per wheel	each	55-58		\$19.95
------------	--	------	-------	--	---------

Bill's Truck Shop

Phone (905) 725-3460 / (905) 725-2022 / Fax (905) 404-2302 email: bill@billstruckshop.com

10-0204-BK



Armrest

			<u>Year</u>	<u>New</u>	<u>Used</u>
10-0204-R	red w/ beige bas	each	55-65	\$59.95	
10-0204-BR	brown	each	55-65	\$59.95	
10-0204-BK	black	each	55-65	\$59.95	
10-0204-G	gray	each	55-65	\$59.95	
10-0204-BL	blue special order	each	55-65	\$69.95	
10-0204-T	turquoise special order	each	55-65	\$69.95	

correct Haircell grain vinyl w/ exact Cameo seat cloth. Cut from factory patterns and sewn to duplicate the original. Kit includes **bumper**

kit , door panel matching cloth , & door panel back boards.

19-3955-RI	Red & Ivory		55-58	Inquire	
19-3955-BI	Beige & Ivory		55-58	Inquire	
19-3955-BLI	Blue & Ivory		55-58	Inquire	
19-3955-CI	Charcoal & Ivory		55-58	Inquire	
19-3955-GI	Green & Ivory		55-58	Inquire	
19-3955-TI	Turquoise & Ivory		55-58	Inquire	

Mirrors

Due to the fluctuation of the Canadian and American dollars call for current prices

Group 20



Mirror Arm Painted

		Year	New	Used
20-302-RP	right	55-59	\$34.95	
20-302-LP	left	55-59	\$34.95	

Mirror Arm Chrome

20-303-RC	right	55-59	\$42.95	
20-303-LC	left	55-59	\$42.95	

Mirror Arm Gasket w/ moulded lip

20-303-G	each	55-59	\$2.00	
----------	------	-------	--------	--

Mirror Arm Screw Set -R side will require nuts

13-0MS	stainless steel	set of 3	55-70	\$4.95
13-0MS-A	OE collared style-philips drive-steel	set of 3	55-70	\$6.95

Outside Mirror Head

When setting the mirror head for viewing loosen the 3 set screws on back of head & tighten when in desired location-this prevents scratching the pivot ball and future rusting-also lube w/ grease

20-0PM	round/ribbed/painted	47-70	\$17.95	
20-0CM	round/ribbed/chrome	47-70	\$23.95	
20-0PRM	rectangular/painted	47-70	\$24.95	
20-0SRM	rectangular/stainless	47-70	\$27.95	

Peep Mirror Chrome Plated.

mirror, bracket clamps on top edge of door.

20-0PM-C	4" w/ curved arm-chrome	L or R	\$34.95	
9-0PM-S	4" w/straight arm-chrome	L or R	\$36.95	

Inside Mirror Head - Day/Night

20-0206-DN	Chrome	54-59	\$69.95	
------------	--------	-------	---------	--

Inside Mirror Head

20-0306	Stainless Steel	54-59	\$34.95	
---------	-----------------	-------	---------	--

Inside Mirror Bracket

20-306-B	w/ screws	55-59	\$31.95	
----------	-----------	-------	---------	--

Vanity Mirror w/ CHEVROLET

9-0VM	OE option	for sun visor	47-66	\$35.95
-------	-----------	---------------	-------	---------

Bill's Truck Shop

Phone (905) 725-3460 / (905) 725-2022 / Fax (905) 404-2302 email: bill@billstruckshop.com

Wipers

Due to the fluctuation of the Canadian and American dollars call for current prices

Group 21



Electric Wiper Motor with switch & wiring-USA made-switch will accept original knob			
21-301-55	2 speed	55-57	\$449.95
21-301-58	2 speed	58-59	\$449.95
21-0200	pulse wiper control 3 speed w/ washer—accepts 5-304-B bezel	47-72	\$139.95
Bushing kit w/ new electric wiper motor			
21-0001	4 replacement nylon bushing w/ washers		\$7.95
Electric Wiper Motor 12V original used tested			
21-301-55U	when available	55-57	\$175.00
21-301-58U	when available	58-59	\$175.00
Wiper Knob—fit OE wiper controls only			
5-304	chrome w/ 9/32 hole & set screw	55-59	\$19.95
5-304-A	black w/pentagon hole & set screw /paint white for GMC	55-59	\$9.95 \$5.00
Wiper Switch -will not accept original knobs			
5-304-B	accepts bezel 5-304-B		
21-0201-S	universal 2 speed switch w/o washers	47-58	\$23.95
Wiper Switch Retainer/Bezel			
5-304-B	fits OE & replacement switches	55-59	\$12.50
Wiper Motor Control			
21-301-E	manual control & cable w/ electric wipers	55-59	\$25.00
21-302-V	manual control & cable w/ vac wipers- 11" long cable	55-59	\$25.00
21-302-S	switch w/ electric wipers w/ 2 pin connector	58-59	\$25.00
Wiper Motor Slider			
21-302-55S	plastic control slider on electric motor	55-57	\$11.95
Wiper Motor Mount kit			
21-301-MK	well nut w/ screw, washer to secure bkts to cab w/ OE wiper motors as required-	each 55-59	\$3.25
Wiper Arm - Stainless Steel			
21-0303-L		left 54-59	\$22.95
21-0303-R		right 54-59	\$22.95
Wiper Blade			
21-303-B	stainless steel	each 55-59	\$21.95

Bill's Truck Shop

Phone (905) 725-3460 / (905) 725-2022 / Fax (905) 404-2302 email: bill@billstruckshop.com

Wipers

Due to the fluctuation of the Canadian and American dollars call for current prices

Group 21

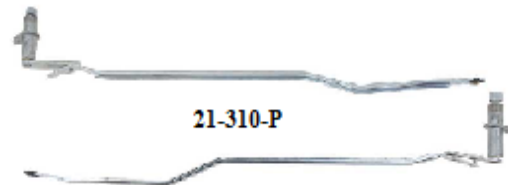

21-0206-VH



13/16

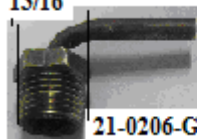

21-0206-F



21-0206-H



Wiper to Cowl Bezels

21-305-B chrome pair 55-59 \$38.95

Wiper to Cowl Bezel Gaskets

21-305-G installs under dash @ transmission pair 55-59 \$3.95

Washer Nozzles

21-305-WN pair 55-59 \$6.50

Wiper Bezel Nuts

21-0205-N pair 47-59 \$8.95

Wiper Transmission Arm Grommets

21-309 for 58/59 w/ electric wipers pair 58-59 \$2.50

Wiper Transmission Arm Retainer & Spring

21-0209-1 54-59 4.50

Wiper Transmission Arm and Pivot

21-310-L. left 55-59 \$75.00

21-310-R right 55-59 \$75.00

21-310-P pair 55-59 \$225.00

Vacuum Hose –vacuum wiper to engine outlet

21-0206-VH 3' 7/32 dia hose 47-59 \$2.00

Vac Outlet on Intake Manifold

21-0206-F brass 90 deg -----3/8 OD 47-59 \$8.95 \$5.00

21-0206-G brass 90 deg----- 13/16 OD \$8.00

21-0206-H brass 90 deg -----13/16 OD---pr 47-59 \$14.50

Windshield Washer Pump

21-0211-U Electric (universal) \$38.95

Bill's Truck Shop

Phone (905) 725-3460 / (905) 725-2022 / Fax (905) 404-2302 email: bill@billstruckshop.com

Please pay close attention when ordering heater parts- there seams to be at least 4 different types/designs of heater in Chev & GMC trucks – we have added some pictures

Year New Used

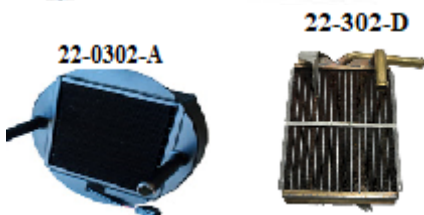
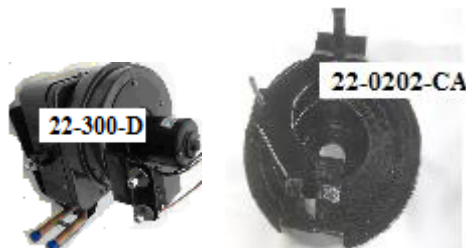
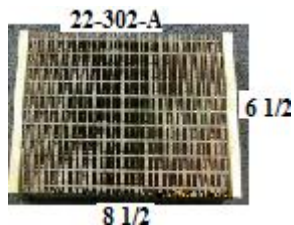

Heater Core-NEW copper cores ONLY -US made Chev and GMC application

22-302-A	approx 8 1/2 long x 6 1/2 wide-core only	55-59	Inquire
22-302-B	approx 7 long x 6 1/2 wide-core only	55-59	Inquire
22-302-S	standard heater includes end support bkts- 8 3/4 x 6 3/4 x 3 1/4 tube spacing/90 deg-----NEW CORE	55-59	Inquire
22-302-S-R	rebuilt std heater includes end support bkts- 8 3/4 x 6 3/4 x 3 1/4 tube spacing/ 90deg Repaired OE unit	55-59	Inquire
22-302 -D	dlx heater core-includes water valve support- 7 1/2 x 6 3/4 x 2 3/4 NEW copper/brass CORE	55-59	\$299.00
22-302-D-R	rebuilt dlx heater-includes water valve support 7 1/2 x 6 3/4 x 2 3/4 Repaired OE unit	55-59	NLA

Heater Core Assembly w /12v motor

22-0302-A	replacement assembly w/ 12 V motor –new square core w/ round tanks- must install support from old assembly	47-57	\$449.95
-----------	--	-------	----------

Heater Core Assembly (copper) w/ 11/16 pipe outlets

22-0202-CA	round assembly- no motor	47-57	\$389.95
------------	--------------------------	-------	----------

Bill's Truck Shop

Phone (905) 725-3460 / (905) 725-2022 / Fax (905) 404-2302 email: bill@billstruckshop.com



22-310-L



22-0209

22-306-DP-G 22-305-DP-G



23-301-C

Defroster Outlets

22-310-L	original steel	55-59	\$25.00
22-310-R	original steel	55-59	\$25.00
22-310-P	ABS plastic- fits L o R each	55-59	\$34.95

Defroster Duct Hose-OE cloth style

22-0209	2" x40"	54-63	\$54.95
22-0209-P	plastic 2 "	54-63	\$32.95

Heater Delete Plate-dash

22-305-DP-C	Chev	55-59	\$25.00
22-306-DP-G	GMC	55-59	\$25.00

Deluxe Heater Side Delete Plate

22-301-C	at right side kick panel w/ screws	55-59	\$10.00
----------	------------------------------------	-------	---------

Heater Accessory Kit

22-0201 a compact 12 volt replacement-includes switch & cable operated defrost -does not include hose & vents 5/8 pipe outlets-2" defrost outlets -add-defrost hose #4-0051P & grommet # 18-310-G x2---use 5/8 heater hose \$289.95

		<u>Year</u>	<u>New</u>	<u>Used</u>
Please pay close attention when ordering heater parts- there seams to be at least 4 different types/designs of heater in Chev & GMC trucks – we have added some pictures				
Deluxe Heater Bands -heater box to side panel housing				
22-301-S	w/ Deluxe/ Fresh air heaters	55-59	\$8.95	
Heater Motor- may require drilling new stud mount holes				
22-0759-12V	12 V motor for round style heater cores w/ ¼ inch dia shaft-2 5/16 stud –3.75 body length- 2 way rotation			
	Recirculating Heater includes 5/16 shaft adapter sleeve	47-59	\$124.95	
22-0203-HM12	12 V motor for rectangular heater w 5/16 shaft –mount bolt spacing 2 5/16---3 5/16 “ body length 2 wire for rev or forward rotation all w/ Deluxe/ Fresh air heaters	47-66	\$99.95	
Dlx Heater Control Valve				
22-304	55-56 w/ deluxe heater with 5/8 tube & will also work on 57 to 59	55-59	\$159.95	
Dlx Heater Control Valve Hose-check heater core pipe size for water valve				
22-304-H	5/8 & ¾ ID ends- curved hose @ valve	55-59	\$22.95	
22-304-H1	5/8 & 5/8 ID ends curved hose	55.59	\$16.95	
Heater Control Valve Seal				
22-0204-S	Ranco valve seal	47-63	\$22.95	
Water Control Valve				
22-0299	heater hose-manual control water valve -pull to open 5/8 by 5/8 hose dia- can use 55-59 (T) throttle cable to operate	47-87	\$42.95	
Heater Hose Water Shut-off Valve-manual				
22-0206	5/8 hose to 3/8 pipe	37-62	\$49.95	
22-0206-A	5/8 in 5/8 out	37-62	\$34.95	
Heater Hose Retainer w/ screw				
22-0205	original used- on pass inner fender	40-59		\$5.00
Heater Hose				
Accel				
18-0401	5/8 black-per foot		\$2.00	
18-0402	3/4 black-per foot		\$2.00	
Heater Control Assembly/dlx -complete w/ levers & switch				
22-305-A	Chev	55-59	\$349.95	
22-306-A	GMC	55-59		Inquire

Bill's Truck Shop

Phone (905) 725-3460 / (905) 725-2022 / Fax (905) 404-2302 email: bill@billstruckshop.com

Heater

Due to the fluctuation of the Canadian and American dollars call for current prices

Group 22

			<u>Year</u>	<u>New</u>	<u>Used</u>
Heater Control Bezel	chrome				
22-305-B	Chev		55-59	\$69.95	
22-305-B-G	GMC		55-59		inquire
Heater Backing Plate - for lens					
22-305-P	black -Chev only		55-59	\$3.50	
22-305-GP	black-GMC only		55-59		inquire
Heater Control Lens Face					
22-305-DL	Chev only		55-59	\$19.95	
22-305-GL	GMC only		55-59		
Heater Switch					
22-305-S	rotary OE style w/ standard heater w/ black knob-accepts OE chrome knob---2 speed		55-59	\$54.95	
22-305-D	deluxe heater		55-59	\$44.95	
22-205-12V	universal w/ lighted control 10 amp/ 12 volt		47-59	\$24.95	
Heater Switch Screws					
22-305-SS	screws to secure switch to housing w/ dlx heater	pr	55-59	\$2.00	
Heater Levers-----vertical levers only					
22-305-L	Chev	pair	55-59	\$38.95	
22-306-L	GMC	pair	55-59	\$59.95	
Heater Knobs					
22-305-K	w/ deluxe heater 4 pcs black	Chev-GMC	55-59	\$12.50	
22-305-KG	w / deluxe heater 4 pcs/ correct found on GMC trucks	NEW ITEM!!	55-59	\$34.95	
36-309	w/std heaters -chrome w/ 3-1/16 hole &set screw		55-59	\$18.95	
Heater Cables					
	for deluxe heater				
22-305-C	Chev		55-59	\$49.95	
22-306-G	GMC		55-59	\$49.95	
Heater Cable Retainers					
4-0085-K		3 pc	47-87	\$0.75	
Heater Motor Wire Grommet					
22-302-G	@ front housing w/ recirculating heater		55-59	\$2.50	
Heater Wiring Harness, Deluxe					
22-312-H			55-59	\$39.95	
Heater Decal /Defroster Decal					
22-313	for standard recirculating heater		55-59	\$8.95	
Manual Defroster Lever Decal					
22-0212	fresh air & recirculating heater		47-59	\$3.95	

Bill's Truck Shop

Phone (905) 725-3460 / (905) 725-2022 / Fax (905) 404-2302 email: bill@billstruckshop.com

AC O-Ring kit

4-0550-K \$14.95

Hurricane Heat Cool & Defrost Unit, Deluxe Control, Wire Harness, Electric Bypass Heater valve, Expansion Valve, Duct Hose, Louvers, Plastic Glove Box, Mounting Brackets and Necessary Hardware.

Inquire

AC w/ heater kits-mounts in original heater location—due to the many engine options today call for information & pricing

-may require upgrade to electric fan & shroud to increase cooling output

-Chev & GMC have diff dash design-picture shows Chev w/ dlx in dash control

Kits- can be purchased w/ or w/ comp & bkts Chev—w/ electronic or manual control in or under dash

---- engine size & comp location

GMC—w/ electronic under dash control

AC & Defrost hose

4-0051P Plastic AC & defrost hose 6' x 2" \$34.95

4-0053P Plastic AC & defrost hose 6' x 2 1/2" \$34.95

4-0054P Plastic AC & defrost hose 6' x 3" \$34.95

4-0055P Plastic AC & defrost hose 6' x 3 1/2" \$34.95

4-0056C Cloth AC & defrost hose 6' x 3 1/4" \$99.50

Bill's Truck Shop

Phone (905) 725-3460 / (905) 725-2022 / Fax (905) 404-2302 email: bill@billstruckshop.com

Hood-Fender Emblem

Due to the fluctuation of the Canadian and American dollars call for current prices

Group 23

		<u>Year</u>	<u>New</u>	<u>Used</u>
HOOD EMBLEM-Front				
Chev				
23-301-55	chrome w / black painted details & red bowtie	55-55	\$389.95	Inquire
23-301-55V	chrome w / black painted details & red bowtie w / V eight note-outside mount holes 18" apart	55-55	NA	Inquire
23-301-56		56-56		Inquire
23-301-56V	chrome w/ black details & red painted bowtie w / v eight note-outside mounting holes 22 ½ 'apart	56-56	\$349.95	Inquire
23-301-57V	chrome w/ red painted details & black bowtie w / v eight note-outside mounting holes 22 ½ apart	57-57	\$399.95	Inquire
23-301-58		58-58		Inquire
23-301-58V	for V8 trucks	58-58		Inquire
23-301-59		59-59		Inquire
23-301-59V	for V 8 trucks	59-59		Inquire
Fender Emblem				
3100 for US & 1300 for Canada built trucks				
23-302-55	3100 chrome w/ white details pair	55-55	\$489.95	Inquire
23-302-55-A	1300 <i>Canadian production</i>	55-55		Inquire
23-302-56	3100 chrome w/ black details 4 pc set	56-56	\$439.95	Inquire
23-302-56-A	1300 <i>Canadian production</i>	56-56		Inquire
23-302-57	3100 chrome w/ red details pair	57-57	\$309.95	Inquire
23-302-57-A	1300 <i>Canadian production</i>			Inquire
23-302-57C	3124 chrome w/ red details/ Cameo pair	57-57	\$459.95	Inquire
23-302-58	3100	58-58		Inquire
23-302-58-A	1300 <i>Canadian production</i>	58-58		Inquire
23-302-59	3100	59-59		Inquire
23-302-59-A	1300 <i>Canadian production</i>	59-59		Inquire

Inquire for any other emblems.

Bill's Truck Shop

Phone (905) 725-3460 / (905) 725-2022 / Fax (905) 404-2302 email: bill@billstruckshop.com

Bed Side Emblems-FLEETSIDE

23-310-58 w/ hdw made in USA each 58-59 \$89.95

Emblem Fasten 8 x 10-24x1 studs & 8 high dome
nuts 16 pcs 47-59 \$12.95
23-0727

Hood Ornament – rockets

23-308-55 die cast/chrome bird 55-56 \$375.00

23-308-57 die-cast/chrome hood rockets pair 57-57 \$949.95

Hydramatic Emblem

23-304-57 on doors for automatic trucks pair 57-57 \$29.95

Fender / Door Emblem for V8

23-306-55 V8 on fender pair 55-56 \$74.95

23-306-57 on door pair 57-57 \$48.00

Napco Emblem

23-0344 hood & fender each 51-59 \$114.95

Napco Dash Plate-shift pattern

23-0345 metal plate on dash 54-59 \$39.95

Grills- Trim

Due to the fluctuation of the Canadian and American dollars call for current prices

Group 24

	<u>Year</u>	<u>New</u>	<u>Used</u>
GMC Grill			
GMC grill /eyebrows/ bullets/mls			inquire

Bill's Truck Shop

Phone (905) 725-3460 / (905) 725-2022 / Fax (905) 404-2302 email: bill@billstruckshop.com

	GMC Grill	<u>Year</u>	<u>New</u>	<u>Used</u>
GMC grill /eyebrows/ bullets/mlds				inquire
Bumper Bullets				
24-303-55-B bumper bullets w/ concave end and support for eyebrow chrome-	pair	55-56		Inquire
24-303-55-BP painted	pair	55-56		Inquire
24-303-57-B bumper bullets have cone in end w/ no grille attachment chrome	pair	57-57	\$289.95	Inquire
24-303-57-BP painted	pair	57-57		Inquire
24-303-58C chrome		58-59		Inquire
HOOD Emblem- GMC				
23-303-55 M stainless steel mesh behind hood emblem	GMC	55-early 56	\$259.95	Inquire
23-303-55	GMC	55-57		Inquire
23-303-58	GMC	58-59		Inquire
<i>Grille Series Emblem</i>				
23-303-?		55-57		Inquire
FENDER Emblem				
23-305-GMC	GMC	55-57		Inquire
23-305-57G-V8 chrome/ GMC w/ V8 engine	pair	55-57	\$179.90	
23-305-58G-V8 chrome/ GMC w/ V8 engine	pair	58-59	\$179.90	
GRILL				
23-357-GP painted grill bars		57-57		Inquire
23-357-GC chrome grill bars		57-57		Inquire
23-358-GP painted grill		58-59		Inquire
23-358-GC chrome grill		58-59		Inquire
Grill Emblem				
23-358-CG 9314 Canadian production		58-59		Inquire
23-358-G 9310 American production		58-59		Inquire
Grille Emblem Support				
23-358-GS chrome stand for emblem to grille		58-59		\$75.00
Hood Bird				
58-59HB airplane style	GM# 2333755	58-59		Inquire

Grills- Trim

Due to the fluctuation of the Canadian and American dollars call for current prices

Group 24

CHEV	Grill		Year	New	Used
24-301-55	chrome		55-56	\$699.95	Inquire
24-301-55P	paint		55-56	\$550.00	Inquire
				\$1099.9	
24-301-57	chrome		57-57	5	Inquire
24-301-57P	white		57-57	\$849.95	Inquire
24-301-58	chrome w/black accent letters		58-59	\$699.95	Inquire
24-301-58P	paint		58-59		Inquire
Headlamp Bezels w/ screws					
16-355-B	chrome w/ seals	pair	55-57	\$179.95	\$60.00
16-355-B-P	OE used paint	pair	55-57		\$60.00
16-358-B	chrome	pair	58-59	\$149.95	\$60.00
16-358-B-W	OE used white	pair	58-59		\$60.00
Grill Hardware Install kit					
24-301-55K	to install grille	12 pcs - Chev only	55-56	\$17.95	
24-301-57K	to install grille	17 pcs- Chev only	57-57	\$12.95	
24-301-58K	to install grille	8 pcs-Chev & GMC	58-59	\$12.95	
Grille-supports to grille- outer & inner					
24-301-58SK		12 screws w/nuts	58.59	\$2.95	
Headlight Bezel Screws= stainless steel					
16-355-S		6 pcs	55-57	\$2.50	
16-358-S		8 pcs	58-59	\$2.00	
Headlamp Bezel Seals w/ wire core as original					
16-0207-1		pair	47-57	\$19.95	
Grill Decals					
24-302-58B		black	58-59	\$7.95	
24-302-58W		white	58-59	\$7.95	

Bill's Truck Shop

Phone (905) 725-3460 / (905) 725-2022 / Fax (905) 404-2302 email: bill@billstruckshop.com

Cab Trim		<i>inquire on individual used pcs</i>	
24-304-C	stainless steel w/clips- deluxe cab	55-59	\$224.95
INDIVIDUAL PIECES NEW-			
INQUIRE			
24-304-LD	left door	55-59	Inquire
24-304-RD	right door	55-59	Inquire
24-304-LU	rear cab upper left	55-59	Inquire
24-304-RU	rear cab upper right	55-59	Inquire
24-304-LL	rear cab lower right	55-59	Inquire
24-304-RL	rear cab lower right	55-59	Inquire
24-304-CR	clip kit for cab trim –fits OE trim holes only (NO water seal on clip) 50 piece kit	55-59	\$22.95
24-304-C1	push in spring clip	each 55-59	\$0.50
24-304-SC	nut on clip & door end upper	each 55-59	\$5.50

Bill's Truck Shop

Phone (905) 725-3460 / (905) 725-2022 / Fax (905) 404-2302 email: bill@billstruckshop.com

Bed Trim Decal

24-3155 bright red reflective decal behind underneath rear trim mld set 58-59 \$11.95

Bed Mld End Trim set-4pc

24-3156 end pcs for short/long bed truck w/ stainless mld-chrome die cast w/ red decals 58-59 \$449.95

24-3156-F front spear w/ hdw each 58-59 \$45.00

24-3156-R rear chevron w/ hdw each 58-59 \$150.00

Hardware kit-bed mld end trim

24-3156-K washers, spacers, nuts & screws to install chrome end pcs 58-59 \$12.95

Bed Mlds beautiful stainless steel (436) mlds - upper is the same as lower on opposite side **made in Canada** available for long & short bed sold as each —check our website gallery for pictures of these trucks w/ our mlds installed short are 68" long – original short have 9 holes & long have 9 per mld- when installing for the 1st time we recommend 5 holes- 2 nut on in wheel arch area and 3 push in outward

View our website gallery 1955-59 and see some trucks w/ our mlds **NEW PRICE**

24-3157 upper left also fits lower right **short bed** each 58-59 \$175.00

24-3158 upper right also fits lower left **short bed** each 58-59 \$175.00

24-3159 upper left also fits lower right **long bed** each 58-59 \$175.00

24-3160 upper right also fits lower left **long bed** each 58-59 \$175.00

Mld Retainers as required

24-3000 (5/16--.3125 hole) push in clip each 58-59 \$2.95

24-3001 nut on clip w /hdw each 58-59 \$2.95

Bed Side Emblems-FLEETSIDE

23-310-58 w/ hdw made in USA each 58-59 \$89.95

Emblem Fastener kit

23-0727 8 x 10-24x1 studs & 8 high dome nuts 16 :pcs 47-59 \$11.95

Bill's Truck Shop

Phone (905) 725-3460 / (905) 725-2022 / Fax (905) 404-2302 email: bill@billstruckshop.com

Rims-Hubcaps-Trim Rings

Group 24

			<u>Year</u>	<u>New</u>	<u>Used</u>
Hubcaps					
Chevy fits 15 and 16 clip style rims					
24-305-55	chrome w/ Bombay Ivory painted details-each		55-56	\$129.95	
24-0305-57	chrome w/ black painted details each		57-60	\$119.95	
GMC fits 15 and 16 clip style rims					
24-306-55G	chrome w/ red painted details -each		55-59	\$109.95	
Smooth- Baby Moon style					
24-0205-S	stainless steel/smooth---w/ clip styles wheels only each			\$79.95	
24-0205-8	chrome/smooth ---fit outside ear wheels only 10 1/8 OD chrome			\$36.95	
Full Wheel Covers -Cameo & deluxe trucks					
24-307-C	full stainless steel w/ painted details each		55-55	Inquire	
Deluxe Wheel Beauty Ring					
24-307-TR	3' wide chrome ring w/ out black lines - used on 55-56 trucks but will fit 57-59 set of 4 - 15"		55-56	\$90.00	
Dlx Wheel Cover Retainers					
24-307-R	(20)		55-55	\$85.00	
Beauty Ring (stainless steel)					
24-007-15S	15 inch w/ smooth face	each	47-87	\$39.95	
24-007-15R	15-inch w/ ribbed face	each	47-87	\$39.95	
24-007-16S	16 inch w/ smooth face	each	47-87	\$39.95	
24-007-16R	16 inch w/ ribbed face	each	47-87	\$39.95	
Moon Hub Caps—Salt Flat style					
24-0201-15	15 " wheels brushed stainless steel each			\$27.95	

Bill's Truck Shop

Phone (905) 725-3460 / (905) 725-2022 / Fax (905) 404-2302 email: bill@billstruckshop.com

Rims-Hubcaps-Trim Rings**Group 24**Used**Rims Original Style used southern clip wheels**

15 -16 " wheels 4 - 4 ½-5 - 5 ½ -6 width 47-62 \$75.00

Wheel Clips each w/ hdw

Clips for retaining original type hubcaps. each

24-0905-15 for 15 & 16 ' 6 stud rims 37-62 \$4.50

24-0905-15K for 15& 16" 6 stud rim set 5 w/
hdw 37-62 \$19.9524-0905-17 for 15-16-17 up 8 stud in rims
& up 47-62 \$5.00***Bill's Truck Shop*****Phone (905) 725-3460 / (905) 725-2022 / Fax (905) 404-2302 email: bill@billstruckshop.com**

Bumpers-Brackets

Due to the fluctuation of the Canadian and American dollars call for current prices

Group 24

			<u>Year</u>	<u>New</u>	<u>Used</u>
Bumpers –Premium Quality – triple nickel plated, and then chromed to a mirror finish -Ft bumpers require drilling for GMC trucks					
Front bumpers also fit rear panel or sub					
24-314-FC	front chrome and 55-59 panel/suburban rear	w/o plate bkt holes	55-59	\$379.95	Inquire
24-314-FC-58	correct for 58-59 w/ licence bkt holes	NEW item !!	58-59		Inquire
24-314-FP	front painted		55-59	\$299.95	Inquire
24-314-RC	rear chrome	stepside	55-59	\$359.95	Inquire
24-314-RP	rear painted	stepside	55-59	\$299.95	Inquire
24-314-RFC	rear chrome	fleetside	58-59	\$359.95	Inquire
24-314-RFP	rear painted	fleetside	58-59	\$299.95	Inquire
Bumper Bolts w/ hardware					
1-0BBC	chrome w/. High dome head	each	47-72	\$5.95	
1-0BBS	stainless steel capped	each	47-72	\$5.95	
1-0BBP	BLACK NEW ITEM	each	47-72	\$6.50	
Bumper Bracket Kit Front w/ hardware					
24-316-F55	inner & outer		55-57	\$159.95	
24-316-F55-L	outer	left	55-57		\$25.00
24-316-F55-R	outer	right	55-57		\$25.00
24-316-F58	inner & outer		58-59	\$159.95	
34-316-F58-L	outer	left	58-59		\$25.00
34-316-F58-R	outer	right	58-59		\$25.00
24-316-F		inner – pair	55-59		\$40.00
24-316-RSP	suburban/panel outer bkts-	pair	55-59		
Bumper Bracket Kit Rear w/ hardware					
24-316-RS	inner & outer	stepside	55-59	\$139.95	
24-316-RF	inner & outer	fleetside	58-59	\$189.95	
24-316-C	inner & outer	Cameo	55-58	Inquire	
24-316-SP	suburb/panel rear outer	pair	55-59	\$79.95	
Bumper Guards					
Stamped steel, chrome plated with hardware.					
24-317		pair	55-59	\$199.95	
License Plate Bracket & Lamp Assembly					
18-303-S	stepside		54-59	\$45.95	
18-0303-F	fleetside-mounts to bumper		58-66	\$57.95	
18-0812	plate bracket Bolt kit		58-66	\$4.50	
18-0303-L	plate light lens		58-66	\$9.95	
18-0303-G	plate light lens gasket		58-66	\$1.50	

Bill's Truck Shop

Phone (905) 725-3460 / (905) 725-2022 / Fax (905) 404-2302 email: bill@billstruckshop.com

Filler Panels-Grille Bars-Plate Bracket

Group 25

				<u>New</u>	<u>Used</u>
Front Splash Apron / Bumper Filler/Lower Grille					
Bar	below grille behind bumper	NEW			
PRICE!!!					
25-301-55	(w/ grille supports)	Chev	55-56	\$179.95	\$75.00
25-301-57	(w/o grille supports)	Chev	55-57	\$169.95	\$75.00
25-301-55G		GMC	55-57		\$100.00
25-301-58		Chev & GMC	58-59	\$144.95	\$75.00
Supports- lower splash apron					
25-301-58S	L or R		58-59		\$25.00
Upper Grill Bar					
25-302-55		Chev	55-56	\$119.95	\$50.00
25-302-57	recessed at grille mount holes	Chev	57-57	\$119.95	\$50.00
25-302-55G		GMC	55-57		Inquire
25-302-58G		GMC	58-59		Inquire
Front License Bracket					
25-303-55	mounts on right side lower valance				
Chev - black			55-57	\$15.95	
25-303-55-G	requires using 58-59 Chev and drilling the bumper	GMC	55-57	NLA	
25-303-58	black	Chev & GMC	58-59	\$24.95	
25-303-58SS	stainless steel /	Chev & GMC	58-59	Inquire	

Bill's Truck Shop

Phone (905) 725-3460 / (905) 725-2022 / Fax (905) 404-2302 email: bill@billstruckshop.com

		<u>Year</u>	<u>New</u>	<u>Used</u>
Wood -Cut to size with edges grooved, sanded and ready to finish, ----not drilled for mounting holes-3/4 kilned dried boards				
red oak				
26-0238	short step	54-59	\$724.95	
26-0252	long step 89"	54-57	\$759.95	
26-3254	long step 97"	57-59	Inquire	
26-0433	long step – 1 ton 107 ¼ "	54-59	Inquire	
26-3260	short fleetside	58-59	\$769.95	
26-3264	long fleetside	58-59	\$949.95	
Yellow Pine				
26-0239	short step	54-59	Inquire	
26-3173	short step w/ predrilled mounting holes	55-59	Inquire	
26-0253	long step 89"	54-57	Inquire	
26-3255	long step 97"	57-59	Inquire	
26-0359	long step-1 ton 107 ¼ "	54-59	Inquire	
26-3261	short fleet	58-59	Inquire	
26-3265	long fleet	58-59	Inquire	
Heat Shield –to shield exhaust (tailpipe) on wood floor over rear axle-prevents wood from burning				
26-0734	includes hdw	each	47-72	\$16.95

Bed Strips

Due to the fluctuation of the Canadian and American dollars call for current prices

Group 26

		<u>Year</u>	<u>New</u>	<u>Used</u>
Bed Strips – each strip is 1 ½” wide & made of 18 gage material. Stainless steel strips are #430 bright stainless and polished to a beautiful finish. Pre-punched w/ square holes for correct application. Can also order <u>special</u> lengths & hole location- BS =bed strips 7 strips required				
Steel				
26-0018	short step	54-59	\$149.95	
26-0018-A	short step-each	54-59		
26-3048	long step 89"	55-57	\$179.95	
26-3051	long step 97"	57-59	\$179.95	
26-0684	1 ton long step 107" 7 pcs	54-59	\$199.95	
26-3084	long fleetside	58-59	\$189.95	
26-3072	short fleetside	58-59	\$179.95	
Polished Stainless Steel				
26-0016	short step	54-59	\$299.95	
26-0016-A	short step- each strip	54-59	\$44.95	
26-0434	1 ton long step 107 " 7pcs	54-59	\$339.95	
26-3046	long stepside 89"	55-57	\$319.95	
26-3049	long stepside 97"	57-59	\$359.95	
26-3082	long fleetside	58-59	\$469.95	
26-3070	short fleetside	58-59	\$399.95	
Custom "WOW" Bed Strips w/ hidden fasteners				
Polished Stainless Steel: custom strips w/ "T" type bolt slides on bottom of strip				
26-0095	'T " bolts w /hdw as required –short bed requires 7		each	\$6.00
26-0083	97 " long - cut to fit		each	\$99.00
Bed Strip Kit				
7 strips 82 " w/ 49 "T" bolts and angle side hdw				
26-0083-K				\$699.95
Stainless Steel w/ o holes				
26-0634	78 " long PST w/o holes		each	\$44.95
26-0160	89 " long PST w/o holes		each	\$59.95
26-0336	120" long PST wo holes		each	\$84.95
Steel w/ o holes				
26-0007	77 1/8 long w/o holes		each	\$29.95
26-0008	97 " long w/o holes		each	\$39.95
26-0383	120" long w/o holes		each	\$59.95
When installing the bed and angle strip bolts do not over tighten-collapse the lock washer only - the bed strips will collapse when they are over tightened				

Bill's Truck Shop

Phone (905) 725-3460 / (905) 725-2022 / Fax (905) 404-2302 email: bill@billstruckshop.com

Angle Strips

Due to the fluctuation of the Canadian and American dollars call for current prices

Group 27

		<u>Year</u>	<u>New</u>	<u>Used</u>
Angle Strips				
Angle strips are pre-punched with 5/16 holes & can be spot welded or bolted to the sides (pair)				
Steel				
27-0114	short stepside	54-59	\$74.95	
27-3138	long stepside 89"	55-57	\$94.95	
27-3147	long stepside 97"	57-59	\$94.95	
27-0140	long stepside 1 ton	54-59	\$94.95	
Polished Stainless Steel				
27-0112	short stepside	54-59	\$119.95	
27-3136	long stepside 89"	55-57	\$129.75	
27-3145	long stepside 97"	57-59	\$149.75	
27-0437	long stepside 1 ton	54-59	\$159.95	
Angle Covers				
Used to cover the original angle strips on sides can be bolted or welded to the sides. Must pre-drill holes.				
Steel (pair)				
27-0139	97 " long		\$69.95	

Bill's Truck Shop

Phone (905) 725-3460 / (905) 725-2022 / Fax (905) 404-2302 email: bill@billstruckshop.com

Bed Bolt Kits

Due to the fluctuation of the Canadian and American dollars call for current prices

Group 28

		<u>Year</u>	<u>New</u>	<u>Used</u>
Kits include all bolts, nuts, washers to secure angles & strips plus to mount bed to frame				
Zinc-bolt kit				
28-3359	short stepside	55-59	\$89.95	
28-3523	long stepside 89"long	55-57	\$89.95	
28-3290	long stepside 97" long	57-59	\$89.95	
28-0358	1 ton long step 107" long	54-59	\$99.95	
28-3314	long fleetside	58-59	\$109.95	
28-3305	short fleetside	58-59	\$94.95	
Polished Stainless Steel -bolt kit				
28-3357	short stepside	55-59	\$199.95	
28-3521	long stepside 89" long	55-57	\$199.95	
28-3288	long stepside 97" long	57-59	\$199.95	
28-0439	1 ton long step 107" long	54-59	\$199.95	
28-3769	cameo & suburban	55-58	\$289.95	
28-3312	long fleetside	58-59	\$259.95	
28-3303	short fleetside	58-59	\$209.95	
Bed to Frame Kits w/ bolts, nuts & off-set washers-this is included with bed bolt kits				
Zinc				
28-0432	long stepside 89" long	54-57	\$35.00	
28-3420	short stepside	55-59	\$34.95	
28-3496	long stepside 97' long	57-59	\$35.00	
28-3488	cameo & suburban	55-58	\$39.95	
28-3457	long fleetside	58-59	\$41.50	
Polished				
28-3455	long fleetside	58-59	\$89.95	
28-3446	short fleetside	58-59	\$89.95	
28-3418	short stepside	55-59	\$89.95	
Bed Strips & Angles only bolt kit				
Use this kit when hiding bed to frame bolts under your boards				
28-0346	short step	54-59	\$94.95	
Washer				
28-0211	off-set washer-stainless steel 1 1/2 OD w/ 7/16 square hole	34-72	\$12.95	

Bill's Truck Shop

Phone (905) 725-3460 / (905) 725-2022 / Fax (905) 404-2302 email: bill@billstruckshop.com

Bed Parts

Due to the fluctuation of the Canadian and American dollars call for current prices

Group 28

		<u>Year</u>	<u>New</u>	<u>Used</u>
<i>US parts not primed-Overseas parts black primer</i>				
Front Bed Panel				
Original style	made w/ 16 gauge steel			
28-0354-T	stepside made in Taiwan	54-59	\$169.95	
28-3119-T	fleetside-made in Taiwan	58-59	\$349.95	
Embossed	with Chevy Bowtie			
28-0696	stepside made in US	54-59	Inquire	
Front Bed Panel Mounting Bolts				
Steel				
23-0387-S	Cap screw style steel---step & fleetside	54-72	\$11.95	
Stainless Steel				
23-0387-SS	Phillips head stain-steel / step & fleet	54-72	\$19.95	
Wheel Tubs				
28-3WT	fleetside wheel tubs-each	58-59	\$219.95	
Bed Sides				
28-3063	short fleet- left	58-59	\$1599.95	
28-3064	short fleet-right	58-59	\$1599.95	
Braces-bed side to cross sill				
21-0402-FK	set of 4 w/ hdw STEEL fleetside beds	58-66	\$89.95	
			Can be purchased EACH left or right side front or rear	\$20.00
21-0402-FK-C	set of 4 w/ hdw CHROME fleetside beds	58-66	\$109.95	

Due to the fluctuation of the Canadian and American dollars call for current prices

Bill's Truck Shop

Phone (905) 725-3460 / (905) 725-2022 / Fax (905) 404-2302 email: bill@billstruckshop.com

Tailgates

Due to the fluctuation of the Canadian and American dollars call for current prices

Group 29

STEPSIDE / FLEETSIDE		<u>Year</u>	<u>New</u>
Chev			
23-0SCHEV-T	stepside/Chevrolet-Taiwan made	54-87	\$429.95
23-0SCHEV	stepside /Chevrolet US made	54-87	\$604.95
21-0566-C	fleetside / Chev	58-66	\$899.95
GMC			
23-0SGMC	stepside	54-87	\$499.95
23-0SGMC-A	stepside with original GMC script	55-62	\$639.95
21-0566-G	fleetside w / GMC	58-66	\$899.95
BLANK			
23-0SBLANK	stepside	54-87	\$249.95
21-0566-B	fleetside w/ out letters	58-66	\$649.95
Louvered w/ 4 rows 4" wide			
29-0679	stepside-US made	54-87	Inquire
Tailgate Covers			
complete cover that can be welded over tailgate			
Blank			
23-0758	stepside-US made	54-87	\$158.95
Bowtie Embossed			
23-0682	stepside	54-87	\$241.95

Due to the fluctuation of the Canadian and American dollars call for current prices

Bill's Truck Shop

Phone (905) 725-3460 / (905) 725-2022 / Fax (905) 404-2302 email: bill@billstruckshop.com

				<u>Year</u>	<u>New</u>	<u>Used</u>
Tailgate Chain Arm Pivot Bolt w/Lock Nut-used to adjust arm tension						
21-0308-Z	zinc-each			58-66	\$17.95	
21-0308-S	stainless steel-each			58-66	\$24.95	
Tailgate -support/pivot bolt in bed side NEW						
21-0308-BS	fits L & R	each		58-66	\$22.95	
Tailgate Chain Eye Brackets						
22-0308-BL	in gate end	fleetside	left	58-66	\$19.95	
22-0308-BR	in gate end	fleetside	right	58-66	\$19.95	
Tailgate to Bedside Striker/Guide						
22-0308-GS		each w/ bolt		58-66	Inquire	
Tailgate Trunions / Hinge						
22-0547-S	cadmium plated w/ bolts	/stepside	pair	54-87	\$2495	
23-0381	urethane w/ ss bolts	/ stepside	pair	54-87	\$52.95	
22-0566	fleetside /cadmium plated		pair	58-66	\$38.95	\$15.00
21-0510-HK	Bolt kit-fleet side tailgate hinge-4pcs			58-72	\$14.95	
Tailgate Chains w/ chain, hooks & eye bolt (pair)						
21-0401-S	stainless steel - fleetside			58-66	\$99.95	
22-0FZ	zinc / fleetside			58-66	\$44.95	\$20.00
23-0SS	stainless steel /stepside			54-87	\$94.95	
23-0SZ	zinc / stepside			54-87	\$48.95	
Tailgate Chain Covers (pair)						
22-0CCB	black/ stepside			47-87	\$11.95	
22-0CCC	clear / stepside			47-87	\$11.95	
22-0CFB	black/fleetside w/ arm pads			58-66	\$16.95	
22-0CFG	grey/ fleetside w/arm pads	NLA		58-66		
Bed Pad Set - rubber pads						
31-0201-P		10 pcs		54-72	\$14.95	

STEPSIDE

Tailgate Letters

Stepside- Chev

23-0CSB	black / stepside	54-87	\$9.95
23-0CSW	white / stepside	54-87	\$9.95
23-0CSS	brushed stainless steel / stepside	54-87	\$9.95

Stepside- GMC

23-0GSB-55	black w/ OE style script	55-62	\$9.95
23-0GSW-55	white w/ OE style script	55-62	\$9.95
23-0GSS-55	brushed stainless w/OE style script	55-62	\$9.95
23-0GSB	black / stepside	54-87	\$9.95
23-0GSW	white / stepside	54-87	\$9.95
23-0GSS	brushed stainless steel/ stepside	54-87	\$9.95

Fleetside- Chev

21-0CFB	black / fleetside	58-66	\$9.95
21-0CFW	white / fleetside	58-66	\$9.95
21-0CFSS	brushed stainless steel/ fleetside	58-66	\$9.95

Fleetside- GMC

21-0GFB	black / fleetside	58-66	\$9.95
21-0GFW	white / fleetside	58-66	\$9.95
21-0GFSS	brushed stainless steel/ fleetside	58-66	\$9.95

Bed Hole Plugs Aluminium plug fits in hole at front and rear of *step side* bed rails. With rubber O-ring -- press in

Blank aluminium polished

31-0649	aluminum-polished-smooth	pair	47-66	\$89.95
31-0649-B	aluminum-brushed	pair	47-66	\$59.95

Bed Roll Light kit-fit 40-66 bed rolls and 40-87 Mark made bed side roll

31-0864	dual intensity LED lights w/ hdw & instructions			\$229.95
---------	---	--	--	----------

STEPSIDE TAILGATE EDGE PROTECTOR

Screw & or urethane to gate

22-0STP	brushed stainless steel		54-87	\$79.95
22-0STP-B	satin black stainless steel		54-87	\$79.95

Step side Stealth Tailgate Latches (pair)

Slotted stainless barrel w/spring loaded lock pin that is installed into the top gate roll & inserts in gate post

22-0SLK-S	stainless steel	pair	41-87	\$199.95
22-0SLK-Z	zinc coated	pair	41-87	\$94.95
21-0266	fleetside-Zinc	pair	58-66	\$159.95
21-0266-S	fleetside-stainless steel	pair	58-66	\$199.95

Tailgate Arm Link kit- w/ instructions

Stepside

29-0834	arms w/ hdw for removal of chains-stepside		54-87	\$169.95
29-0834-S	arms w/ hdw for removal of chains stainless steel		54-87	\$239.95

Fleetside

21-0837	arms w/ hdw for removal of chains- fleetside		58-66	\$169.95
21-0837-S	arms w/ hdw for removal of chains- fleetside stainless steel		58-66	\$239.95

Bill's Truck Shop

Phone (905) 725-3460 / (905) 725-2022 / Fax (905) 404-2302 email: bill@billstruckshop.com

Bed Parts

Due to the fluctuation of the Canadian and American dollars call for current prices

Group 30

		<u>Year</u>	<u>New</u>	<u>Used</u>
Bed Cross Sill	pre-drilled w/ support plates			
30-3427	galvanized stepside	55-59	\$79.95	
30-3483	#3-recessed @ rear shackle /short stepside	55-59	\$79.95	
<i>ends are stamped w/ recess for spring shackle</i>				
30-3433	Cross sill -each fleetside	58-59	\$62.95	
Short fleet has 3 cross sills & 1x 50 "rein				
/ long fleet has 5 cross sills& 2 x 50 " reinforcement				
Reinforcement Strip predrilled				
30-0437	50 "- 58/59 fleetside between wheel tubs and 54/59 long step	54-59	\$44.95	
23-0706	w/ out holes stepside	54-87	\$25.00	
Rear Cross Sill predrilled w/ support brackets				
30-3715-T	stepside	55-59	\$199.95	
30-3720	fleetside	58-59	\$299.95	
21-0722-HK	Rear cross sill hdw kit	54-87	\$13.95	
ROLL PANS				
Rear Roll Pan (steel) weld or bolts to rear cross sill				
And bed sides with NO tag lights holes				
With License Box				
30-0826-T	smooth w/licence box/made in Taiwan	54-87	\$224.95	
30-0852	4 row louvered w /plate box stepside	54-87	Inquire	
30-3118	smooth w/plate box fleetside	58-59	Inquire	
30-3119	4 row louvered w / plate box fleetside	58-59	Inquire	
24-0483	smooth – long stepside	54-87	\$279.95	
Without License Box				
24-0817	smooth / stepside	54-87	\$157.70	
24-0839	smooth 4 row louvered / stepside	54-87	\$239.95	
24-3819	smooth / fleetside	58-59	Inquire	
30-3853	smooth 4 row louvered / fleetside	58-59	Inquire	
Rear Roll Pan Tag Light				
30-0204-T	top mount w/ chrome bezel		\$6.50	
Rear Step Fender Bolt Kit w/ bolts, washers& nuts				
31-0202-SS	stainless steel with clutch type head	47-66	\$62.95	
31-0202-SS-P	stainless steel w/philips head screw	47-66	\$69.95	
25-06025	zinc w/ Phillips head	47-72	\$19.95	
Rear Step Fender Welt Beading				
31-0FWB	black vinyl 25'	47-72	\$21.95	

Bill's Truck Shop

Phone (905) 725-3460 / (905) 725-2022 / Fax (905) 404-2302 email: bill@billstruckshop.com

Box Parts

Due to the fluctuation of the Canadian and American dollars call for current prices

Group 31

			<u>Year</u>	<u>New</u>	<u>Used</u>
<p>Bed sides are made from 16 gauge electro-galvanized steel and come with angels installed, stake pockets, fender holes, USA are not primed. Bed sides can be ordered with many different options: e.g., no pocket holes SS angels, no fender holes. . Inquire if necessary .Items w/ T are off shore produced parts</p>					
31-3639	short stepside	left	55-59	\$899.95	
31-3639-T	short stepside-made in Taiwan	left	55-59	\$699.95	
31-3640	short stepside	right	55-59	\$899.95	
31-3640-T	short stepside-made in Taiwan	right	55-59	\$699.95	
31-3639-SA	short step w/ PST angle installed	left	55-59	Inquire	
31-3640-SA	short step w/ PST angle installed	right	55-59	Inquire	
31-3545	long stepside 89"	left	55-57	Inquire	
31-3544	long stepside 89"	right	55-57	Inquire	
31-3546	long stepside 97"	left	57-59	Inquire	
31-3547	long stepside 97"	right	57-59	Inquire	
31-3397	cameo / suburban	left	55-58	Inquire	
31-3384	cameo / suburban	right	55-58	Inquire	
Stake Pocket - vertical post at front & rear of bed					
31-0408	front	left	54-72	\$99.95	
31-0405	front	right	54-72	\$99.95	
23-0414	rear	left	54-66	\$139.95	
23-0411	rear	right	54-66	\$139.95	
Stake Pocket Covers – steel w/ side clips-paint to match					
23-0191	steel/pair		54-87	\$36.95	
23-0192	steel/pair – fleetside		58-87	\$36.95	
Bed Hole Plugs Aluminium plug fits in hole at front and rear of stepside bed rails. With rubber O-ring -- press in. w/ instructions					
Bowtie for Mar-k bed sides					
31-0752	polished w/ bowtie	pair	47-66	\$89.95	
Blank for Mar-k bed sides					
31-0649	polished /blank	pair	47-66	\$69.95	
22-0FLP					
Flip down rear plate bkt				\$39.95	
<p>Due to the fluctuation of the Canadian and American dollars call for current prices</p>					

Bill's Truck Shop

Phone (905) 725-3460 / (905) 725-2022 / Fax (905) 404-2302 email: bill@billstruckshop.com

			<u>Year</u>	<u>New</u>
Running Board				
25-0410-L	short step /	left	55-66	\$235.95
25-0410-R	short step /	right	55-66	\$235.95
25-0410-LC	short step CHROME-	left	55-66	\$399.95
25-0410-RC	short step CHROME-	right	55-66	\$399.95
25-0411-L- long step/step vertical is 24 1/2 long		left	55-66	\$224.95
25-0411-R - long step/step vertical is 24 1/2 long		right	55-66	\$224.95
25-0412-L -long step/step vertical is 28 1/2 long		left	55-66	
25-0412-R -long step/step vertical is 28 1/2 long		right	55-66	
Running board Support				
32-303-L		left	55-59	\$46.95
32-303-R		right	55-59	\$46.95
Running board Step Plates pair w/ hardware				
Polished aluminium-diamond top w/blue Bowtie				
32-004	5 1/4 x 14	pair	47-72	\$99.95
32-005	non pol alum w /older GMC design 5x10 5/8-pr		47-72	\$89.95
Running board Bolt Kit				
25-0510-BK	-at support, sides & fender-Zinc		55-72	\$18.95
25-0510-BKS	chrome bolts w/ hdw-4 bolts		55-72	\$32.95

Due to the fluctuation of the Canadian and American dollars call for current prices

Bill's Truck Shop

Phone (905) 725-3460 / (905) 725-2022 / Fax (905) 404-2302 email: bill@billstruckshop.com

Front Fender Brace

33-304-L	16' high	left	55-59	\$64.95
33-304-R	16" high	right	55-59	\$64.95

Front Fender Lower rear

33-305-L	16" high	left	55-57	\$89.95
33-305-R	16" high	right	55-57	\$89.95
33-305-8L	16" high	left	58-59	\$74.95
33-305-8R	16" high	right	58-59	\$74.95

Door Outer Skin

33-306-L	8" high	left	55-59	\$99.95
33-306-R	8" high	right	55-59	\$99.95

Door Inner w/ Bottom

33-307-L1	9" high	left	55-59	\$139.95
33-307-R1	9" high	right	55-59	\$139.95

Door Post w/ Hinge Pocket "A" pillar

33-308-LF	15" high	left	55-59	\$82.95
33-308-RF	15" high	right	55-59	\$82.95

Door Pillar-Rear "B" Lower @ rocker step

33-308-LR	11 3/16 H	left	55-59	\$69.95
33-308-RR	11 3/16 H	right	55-59	\$69.95

Rocker/ Step w/support brace

33-309-L		left	55-59	\$149.95
33-309-R		right	55-59	\$149.95
2 nd design w/ more defined step lines (like OE) ,rocker support bkt , step support and recessed lip at top to join floor				
33-309-L-A			55-59	\$149.95
33-309-R-A			55-59	\$149.95

Rocker/ Step Support Brace

32-0203-S	30" brace that is welded to bottom on cab step-each		55-59	\$24.95
-----------	---	--	-------	---------

Rocker Step Plate Support

33-309-S	left or right	each	55-59	\$38.95
----------	---------------	------	-------	---------

Rocker Panel Edge

33-310-L		left	55-59	\$74.95
33-310-R		right	55-59	\$74.95

Cab Floor Pans w/toe board

33-311-L	28" L X 24" wide	left	55-59	\$139.95
33-311-R	28" L X 24" wide	right	55-59	\$139.95

Bill's Truck Shop

Phone (905) 725-3460 / (905) 725-2022 / Fax (905) 404-2302 email: bill@billstruckshop.com

Sheet Metal/Repair Panels

Group 33

			<u>Year</u>	<u>New</u>	<u>Used</u>
Rear Cab Support					
33-313			55-59	Inquire	
Front Cab Support					
33-314-L		left	55-59	\$74.95	
33-314-R		right	55-59	\$74.95	
Rock Deflectors @ rear cab corner on stepside trucks					
33-312		pair	55-59	\$22.95	
Cab Corner-outer w /door opening					
33-315-L	15' high	left	55-59	\$84.95	
33-315-R	15"high	right	55-59	\$84.95	
Cab Corner- inner					
33-316-L		left	55-59	\$99.95	
33-316-R			55-59	\$99.95	
Cab Corner Closure Panel <i>NEW ITEM</i>					
33-316-CP	fits left or right side inner floor @ cab corner- comes w/ bend tabs for easy welding to cab-can also be used when NOT installing inner cab corners		each	55-59	\$12.95
Inner Kick Panel Cover with screws					
33-317-L		left	55-59	\$69.95	
33-317-R		right	55-59	\$69.95	
33-317-SK	screw kit	12 pcs	55-59	\$2.50	
Outer Pillar Pocket					
33-321-L		left	55-59	\$92.95	
33-321-R		right	55-59	\$92.95	
Inner Pillar Pocket					
33-322-L		left	55-59	\$89.95	
33-322-R		right	55-59	\$89.95	
Fender Support Bracket @ lower hinge post					
33-324-L		left	55-59	\$34.95	
33-324-R		right	55-59	\$34.95	
Lower Door Hinge Bracket in door w/ fine thread nuts SEE group 12 page 30					
33-325-L		left	55-59	\$59.95	
33-325-R		right	55-59	\$59.95	

Bill's Truck Shop

Phone (905) 725-3460 / (905) 725-2022 / Fax (905) 404-2302 email: bill@billstruckshop.com

			<u>Year</u>	<u>New</u>	<u>Used</u>
Doors					
34-3LD	left		55-59	\$719.95	Inquire
34-3RD	right		55-59	\$719.95	Inquire
Door Hinge Bolts					
New Doors require 3/8 coarse thread bolts on door hinge pockets to secure hinge set of 6 per doors---2 x3/8 -16 x1 1/2 w/ 1 1/8 floating washer & 4 x 3/8-16 x 1 w/ 1" floating washer					
34-3HB-K			55-59	\$10.00	
Fenders – Outer					
34-355-FL	left		55-56	\$789.95	Inquire
34-355-FR	right		55-56	\$789.95	Inquire
34-357-FL	left		57-57	\$789.95	Inquire
34-357-FR	right		57-57	\$789.95	Inquire
34-358-FL	left		58-59	\$789.95	Inquire
34-358-FR	right		58-59	\$789.95	Inquire
Front Sheet Metal hdw kit					
34-355-HK	stainless flat washers & bolts-philips drive to secure fit fenders & hood latch panel 24 bolts w/ washers		55-59	\$39.95	
Front Fender Braces -front					
3-31FSS	polished stainless steel	pair	55-59	\$84.95	
3-31F	steel	pair	55-59	\$42.95	
Fender Extension at fender & rad support					
34-355-LE	left		55-57	\$99.95	
34-355-RE	right		55-57	\$99.95	
34-358-LE	left		58-59		
34-358-RE	right		58-59		
Fenders - Inner					
34-355-IL	uses 56-57 light harn grommet - left		55-57	\$269.95	Inquire
34-355-IR	uses 56-57 light harn grommet - right		55-57	\$269.95	Inquire
34-358-IL	left		58-59	\$249.95	Inquire
34-358-IR	right		58-59	\$249.95	Inquire
Inner Fender Support @ firewall					
34-355-S	left or right	each	55-59	\$10.95	
34-355-S-SS	pair/brushed stainless w/ hdw		55-59	\$29.95	
Rad Support					
34-355-RS	has 4 louvers per side		55-57	\$324.95	\$150.00
34-358-RS	has 3 louvers per side		58-59	\$259.95	\$100.00
Park lamp Harness Grommet					
16-305-G	each side of rad support	pair	55-59	\$5.75	
Grille Surround					
34-358-GS			58-59	\$449.95	Inquire

Bill's Truck Shop

Phone (905) 725-3460 / (905) 725-2022 / Fax (905) 404-2302 email: bill@billstruckshop.com

Sheet Metal

Due to the fluctuation of the Canadian and American dollars call for current prices

Group 34

			<u>Year</u>	<u>New</u>	<u>Used</u>
Hoods					
34-355-HC	smooth	Chev	55-56	\$899.95	Inquire
34-357-HC	w/ spears	Chev	57-57	\$999.95	Inquire
34-355-HG	smooth	GMC	55-56		Inquire
34-357-HG		GMC	57-57		Inquire
34-358-H		GMC & Chev	58-59	\$1299.95	Inquire
				5	
Hood Latch Panel					
34-312-55C		Chev	55-57	\$109.95	\$50.00
34-312-55G		GMC	55-57		\$100.00
34-312-58C		Chev	58-59	\$109.95	\$50.00
34-312-58G		GMC	58-59		\$100.00
V-8-Filler Panel-rad support to latch panel					
34-313-C	Chev w/ factory v8 engine		55-59		\$40.00
Stepside Rear Fenders					
25-0566-R		right	55-66	\$799.95	Inquire
25-0566-L	w/ out spare cut-out	left	55-66	\$799.95	Inquire
25-0566-LS	w/ spare tire cut-out	for LONG			Inquire
STEP	stepside only	left	55-66	\$799.95	
Fender Braces-stepside					
25-359-F	steel @ front step w/treaded end	each	55-59	\$34.95	
25-0566-K	3 pc set per fender		55-66	\$26.95	
25-0566-SSK	fender brace kit stainless steel	6 pc set w/ hdw	55-66	NLA	
Transmission Floor Cover – see section 8					
Cowl Screen					
33-345	OE style		55-59	\$119.95	\$50.00
33-345-A	custom style w/ o grill		55-59	\$109.95	
33-345-C	OE style- chrome		55-59	\$192.95	

Bill's Truck Shop

Phone (905) 725-3460 / (905) 725-2022 / Fax (905) 404-2302 email: bill@billstruckshop.com

Sheet Metal

Due to the fluctuation of the Canadian and American dollars call for current prices

Group 34

	<u>Year</u>	<u>New</u>	<u>Used</u>
Inner Firewall Cowl Panel			
34-360-I	55-59	\$449.95	
Outer Firewall Cowl Panel			
34-360-O	55-59	\$445.95	
Firewall Panel			
34-361 complete replacement panel w/ factory holes- Chev Has 55-57 batter tary hole pattern	55-59	\$532.95	
Cab Rear Panel Outer w/ small back window			
34-359-OS	55-59	\$1199.95	
Cab Rear Panel Outer w/ big back window			
34-359-OB	55-59	\$999.95	
Cab Rear Panel Inner w/ big back window			
34-359-IB	55-59	\$410.00	
Cab Rear Panel Inner w/ small back window			
34-359-IS	55-59	\$249.95	
Cab Rear Panel Inner w/ B-pillar @ big back window			
34-359-IB-B	55-59	\$899.95	

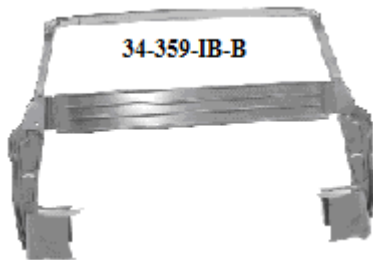

34-359-IB-B



34-359-IB

Due to the fluctuation of the Canadian and American dollars call for current prices

Bill's Truck Shop

Phone (905) 725-3460 / (905) 725-2022 / Fax (905) 404-2302 email: bill@billstruckshop.com

	<u>Year</u>	<u>New</u>	<u>Used</u>
Roof-Outer Skin -includes roof to windshield opening panel			
34-359-RO	55-59	\$729.95	
Roof-Inner skin – includes side drip rails and ft inner w/ braces			
34-359-RI a complete replacement panel-excellent for roof rot repair around front window	55-59	\$695.95	
Roof-front/inner			
34-359-FI replacement for front inner only-wraps around front 6 “ of roof –joins to 34-359-RF	55-59	\$179.95	
Roof to window filler replacement panel			
34-359-RF window pinch weld to outer roof skin	55-59	\$109.95	

33-330-BK



Support Brace- cab floor to rear wall inner support above @ cab support (do not come w/new floor)

33-330-BL w/weld in holes-drivers side	each	55-59	\$29.95
33-330-BR w/weld in holes pass side	each	55-59	\$29.95
33-330-BK	pair	55-59	\$79.95

33-330-BR



33-330-BL

Cab Floor –up to front seam--does not include ft cab supports
33-314 L & R & rear cab braces 33-330-BK

33-330 complete floor w/ steps		55-59	\$1295.95
--------------------------------	--	-------	-----------



		<u>Year</u>	<u>New</u>
Cab "A" Pillar assembly w/ in & outer air box			
34-3360-L	left front pillar	55-59	\$609.95
34-3360-R	right front pillar	55-59	\$609.95
Cab "A" Pillar-full replacement-outer			
34-3361-L	left	55-59	\$224.95
34-3361-R	right	55-59	\$224.95
Cab Kick panel w/ air valve			
34-3362-L	left	55-59	\$271.95
34-3362-R	right	55-59	\$271.95
Cab "B" Pillar-full replacement			
34-3364-L		55-59	\$249.95
34-3364-R		55-59	\$249.95
Cage Nut—weld in support w/ nut & weld in holes - replaces the missing, rusty or stripped nut & support			
34-3363-CN	includes 1 fender bolt 1x 1/16 & 1/8 shim fits left & right	BTS exclusive each	55-59 \$29.95

BTS exclusive



34-3363-CN

34-3362-L



33-318-L



33-318-LP

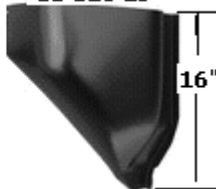

16"

Outer Cowl Air Box-full replacement part

33-318-L	left	55-59	\$104.95
33-318-R	right	55-59	\$104.95

Outer Cowl Air Box-partial repair item

33-318-LP	left	55-59	\$99.95
33-318-RP	right	55-59	\$99.95

Bill's Truck Shop

Phone (905) 725-3460 / (905) 725-2022 / Fax (905) 404-2302 email: bill@billstruckshop.com

Sheet Metal

Due to the fluctuation of the Canadian and American dollars call for current prices

Group 34



Cabs- w/ Chev dash—GMC dash can be installed

		<u>Year</u>	<u>New</u>	<u>Used</u>
34-355-CS	Chev w/ small back window	55-59	Inquire	Inquire
34-355-CB	Chev w/ big back window	55-59	Inquire	Inquire

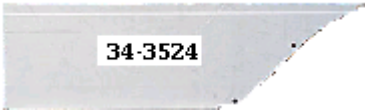

Fleetside Bed Repair Panels

Repair panels for front & rear of wheeltubs-16 gauge electro-galvanized-predrilled holes @ floor and wheel tub

34-3521	front inner left-short fleetside	58-59	\$69.95	
34-3522	front inner right-short fleetside	58-59	\$69.95	
34-3523	rear inner left-short fleetside	58-59	\$69.95	
34-3524	rear inner right-short fleetside	58-59	\$69.95	

Rear Barn Doors-panel/suburban

34-370-L	left	55-59		Inquire
34-370-R	right	55-59		Inquire

Rear Clam Shell

34-371-U	upper	55-59		Inquire
34-371-L	lower	55-59		Inquire

Bill's Truck Shop

Phone (905) 725-3460 / (905) 725-2022 / Fax (905) 404-2302 email: bill@billstruckshop.com

Dash

Due to the fluctuation of the Canadian and American dollars call for current prices

Group 33



Dash Panel

33-340-C	Chev	55-59	\$669.95	Inquire
33-340-G	GMC	55-59		Inquire

Radio- Dash Repair Panel

33-357	w/ all factory holes	Chev only	55-59	\$57.95
33-357-S	smooth replacement panel	10 3/4W x 8 1/2 H		
Chev only			55-59	\$39.95

Bill's Truck Shop

Phone (905) 725-3460 / (905) 725-2022 / Fax (905) 404-2302 email: bill@billstruckshop.com

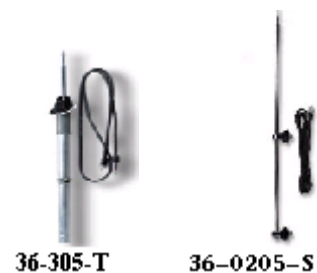

36-305-T 36-0205-S



36-306-C



36-309-S 36-309



36-307-C

36-309-C



36-0307-54G



36-304-DVC

36-312-S



36-312-B



36-312-SK

Original Antenna With cable and hardware,
36-305-T telescopic w/ hardware 55-59 \$139.95

If installing a new ant in the existing hole make sure it is in the correct location as it will only fit in the OE location -fender edge at rear

Side Mount Antenna-universal w/ cable and hardware -stainless steel
36-0205-S dual stand side mount 36-59 \$49.95
36-0205-S1 single stand side mount 36-59 \$39.95

Radio Delete Plate

36-330-C OE plate w/ Chev logo and control button plugs 55-59 \$75.00
36-330-G OE plate w/ GMC logo and control button plugs 55-59 \$75.00

Radio Face Plate Tuning Indicator

36-307-C Chev 55-59 \$15.95
36-0207-54G white screened GMC 54-59 \$19.95

Original Radio-rebuilt w/ one year warranty

36-309-G GMC 12 volt 55-59 \$495.00
36-309-C Chev 12 volt 55-59 \$450.00

Radio Knob chrome

36-309 3/16 hole with lock screw 55-59 \$18.95

Radio Spinner Knobs

36-309-S plastic/chrome pair 55-59 \$14.95

Original Speaker

36-312-S 55-59 \$49.95

Dual Voice Cone Speaker-fits original housing

36-304-DVC 140 watts 55-59 \$89.95

Speaker Cover

36-312-C chrome 55-59 \$89.95
36-312-B black 55-59 NLA

Speaker Cover Screw kit 4 pcs

36-312-SK 4 x 2 1/2 screws 55-59 \$2.50



36-320-KP



5-0HAN



36-3USA-2



5-00RC

Kick panel Speaker set-Plastic panels w/moulded speaker (4 " 2 way 60 watt speakers)-pair

36-320-KP 55-59 \$209.95

36-320 w/o speaker/install you own 55-59 \$139.95

Radio-AM/FM – 55-59 CHEV Radio-AM/FM – new 12V ,electronic shafts, aux inputs for iPod,MP3,DVD,Satellite, seek & scan, digital clock,200 watts w/ chrome bezel & CHEV logo-fits original location w/o any modification-

36-3USA-2 55-59 \$299.95

Amplified Electronic AM/FM Hidden Antenna—requires 12 volt-includes 80” cable- peel- stick application

5-0HAN universal \$49.95

Radio-AM/FM – new 12V ,electronic shafts, aux inputs for iPod,MP3,DVD,Satellite, seek & scan, digital clock,200 watts w/ chrome bezel & CHEV logo-fits original location w/o any modification-**Chev USA 740 W/ BLUETOOTH**

36-3USA-7 55-59 \$499.95

Inquire about 55-59 GMC truck radios

Amplified Electronic AM/FM Hidden Antenna—requires 12 volt-includes 80” cable- peel- stick application

5-0HAN universal \$39.95

Condenser---Radio(noise) Suppression Condenser

5-00RC when using point ignition \$19.95

Bill's Truck Shop

Phone (905) 725-3460 / (905) 725-2022 / Fax (905) 404-2302 email: bill@billstruckshop.com

Brakes

Due to the fluctuation of the Canadian and American dollars call for current prices

Group 37



				<u>Year</u>	<u>New</u>	<u>Used</u>
<i>all 1/2 ton application & bonded unless noted</i>						
Brake Shoes (per axle)						
37-0202-F	1/2 ton front shoes 2" set of 4	51-62	\$49.95	51-62	\$74.95	
37-0202-F/P	premium brand-riveted lining set 2"	51-62		51-62	NLA	
37-0202-R	1/2 ton rear shoes 11x 1 3/4 set of 4	51-58		51-58	\$79.95	
37-0202-F	1/2 ton rear shoes 2" set of 4	51-62		51-62	\$74.95	
37-0330	53-59 front & rear-64-70 rear 3/4 ton Brake shoe set- 12 x 2	53-59		53-59	\$79.95	
We provide brake shoe relining on all large size brake shoes - approx \$ per shoe \$69.00						Inquire
37-0204	14 x 2 1/2 rear set of 4 1 ton	53-59		53-59		Inquire
Wheel Cylinder (each)						
37-0203-FL	1.125 bore front L 1/2ton	51-59		51-59	\$39.95	
37-0204-FR	1.125 bore front R 1/2 ton	51-59		51-59	\$39.95	
37-0303-RL	31/3200--- rear left 1/2 ton and 57-59 31—4x4	55-72		55-72	\$29.95	
37-0303-RR	31/3200-----rear right 1/2 ton and 57-59 3100 4x4	55-72		55-72	\$29.95	
37-0209	3600---- 3/4 & 1 front or rear L or R 1 1/4 bore each	53-59		53-59	\$99.95	
37-0009	3/4 & 1 front L or R w/ 1 1/8 bore each	53-59		53-59		
37-0499	rear cylinder or rear w/ dual cylinder 1 1/2- 2 ton Chev & GMC fit L or R each	53-59		53-59	\$155.00	
37-0500	front cylinder or rear w/ dual cylinder 1 1/2- 2 ton Chev & GMC fit L and R each	53-59		53-59	\$155.00	
Wheel Cylinder Cups						
37-0124	1 1/8 cup size each				\$1.75	
37-0138	1 3/8 cup size---each				\$1.75	
37-0125	1 1/4 cup size each				\$3.95	
Wheel Cylinder Rebuild kit						
37-0054	1 1/4 " bore				\$24.95	
17-0036	1 1/8 " bore				\$20.95	
17-0046	1 " bore				\$11.50	
37-0038	1 3/8 bore				\$36.95	
37-0036	1 3/16 bore				29.95	
Wheel Cylinder Push Rod						
37-0050		each		51-72	\$6.95	
Brake Shoe Guide Plate						
37-0051	1/2 & 3/4 ton	each		51-87	\$9.95	
Bleeder Screw						
17-0402	3/8 head 3/8 x 24	each		47-7	\$1.69	

Bill's Truck Shop

Phone (905) 725-3460 / (905) 725-2022 / Fax (905) 404-2302 email: bill@billstruckshop.com

Brakes

Due to the fluctuation of the Canadian and American dollars call for current prices

Group 37

37-0245



37-0829



38-0250



37-305-RS

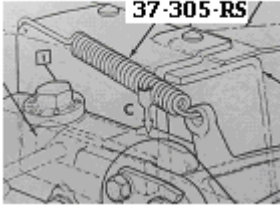

45-0134

Master Cylinder line adaptor

37-0829 5/16 inverted male w/ 1/4 female includes brass washer & 3/16 & 1/4 line fitting

\$7.95

Washer-master cylinder adaptor

37-0245 .800 OD-.500 IN

\$2.25

Brake Pedal Return Spring

37-305-RS

55-59

\$6.95

Backing Plate Plugs

38-0250

each

\$0.85

Hydraulic Brake Light Switch

45-0134 w/ adaptors & 3/16 line fittings & adaptors--closed circuit @ 45PSI

\$32.95

45-0134-S switch only

\$18.60

Bill's Truck Shop

Phone (905) 725-3460 / (905) 725-2022 / Fax (905) 404-2302 email: bill@billstruckshop.com

Brakes

Due to the fluctuation of the Canadian and American dollars call for current prices

Group 37

			<u>Year</u>	<u>New</u>	<u>Used</u>
	Master Cylinder complete new assembly				
	37-305 1 1/8 cup 1/2 - 3/4 - 1 ton		55-59	\$189.95	
	Rebuild Kit Master Cylinder				
	37-0146 1 1/8 bore		51-59	\$48.95	
	37-0033 1 1/4 bore -3/4 - 1 - 1 1/2 - 2 ton		36-59	\$49.95	
	Master Cylinder Fill Cap				
	37-0211 1 1/4 OE metal w/gasket		40-59	\$34.95	
	37-0211-A 1 1/4-plastic w/ gasket		40-59	\$19.95	
	Master Cylinder Boot				
	10-0504-MB w/ manual brakes		47-72	\$6.00	
	Master Cylinder Bracket kit-				
	37-3MCA to convert to dual master w/ hdw		55-59	\$189.95	
	For manual brakes only see page 92 for power brake kits				
	Master Cylinder-dual master for above kit-drum application only				
	17-0505 NEW drum/drum master cylinder-1" bore			\$99.95	
	Master Cylinder w/ prop valve & bracket-when installing updated master under cab w/booster				
	37-0759 disc- drum prop valve w/ lines & bracket		47-59	\$235.95	
	37-0760 disc- disc prop valve w/ lines & bracket		47-59	\$235.95	
	45-0DBK-5				
	Bracket kit w/o master cylinder				
	37-0759-B includes disc-drum valve,lines,harness		47-59	\$144.95	
	Prop valve rear fitting				
	17-0038--Fitting--9/16-18 inverted male to 3/8-24 female			\$6.95	
	17-0016 Fitting--9/16-18 inverted male to 7/16-24 female			\$6.95	
	17-0020 Fitting--9/16-18 inverted male to 1/2-20 female			\$6.95	
	Harness-proportioning valve switch				
	17-0PVK-H replacement harness w/ socket			\$19.95	

Bill's Truck Shop

Phone (905) 725-3460 / (905) 725-2022 / Fax (905) 404-2302 email: bill@billstruckshop.com

Brakes

Due to the fluctuation of the Canadian and American dollars call for current prices

Group 37

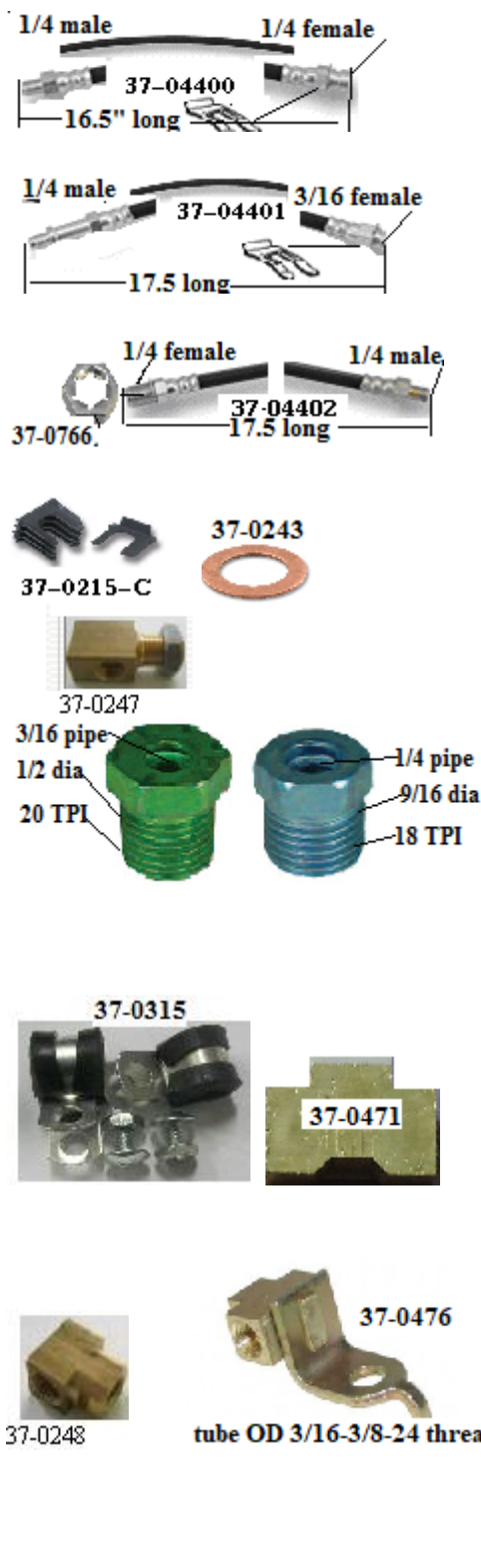

		<u>Year</u>	<u>New</u>	<u>Used</u>
Brake Hose (each) see hose info for correct application when ordering				
37-04400	1/4 line w/Posi traction 1/2 ton rear-each	58-59	\$24.95	
37-04400	1/4 line 3/4 ton rear-each	55-59	\$24.95	
37-04401	3/16 line- 1/2 ton 3100 front-each	57-59	\$36.95	
37-04401	3/16 line- 1/2 ton 3200 front-each	55-56	\$36.95	
37-04402	3/16 line- 1/2 ton longbed front-each	57-59	\$39.95	
37-04402	1/4 line 3/4 ton front-each	55-59	\$39.95	
37-04402	1/4 line 1/2 ton 3100 rear-each	55-59	\$39.95	
Hose ID- #04401 extended wheel cylinder end w/ "U" clip to secure on bkt ///04402 threaded end for nut (#37-0024) to secure through frame/// 04400 "U" clip to secure on support				
Brake Hose Nut				
37-0766	thread nut each		\$1.25	
Brake Hose Gasket				
37-0243	7/16 ID each		\$1.25	
37-0795	3/8 ID each		\$1.25	
Brake Hose Clips (each)				
37-0215-C			\$1.25	
Brake Line Division Block				
37-0247	brake line "T" on R frame rail-secured w/ nut	51-57	\$33.95	\$15.00
Rear Axle Division block				
37-00476	38-70 Rear flex hose splitter block-secures to diff housing bracket w/ clip - flex line 7/16-20 on one side and 3/8-24 on the other 2 sides	51-70	\$26.95	\$15.00
Brake Fitting-oversize				
37-03025	(blue) 1/4 pipe-9/16 dia-18 threads per inch		\$3.50	
37-03026	(gold) 1/4 pipe-1/2 dia-20 threads per inch		\$3.50	
37-03023	(green) 3/16 pipe-1/2 dia-20 threads per inch		\$2.00	
37-03024	(olive) 3/16 pipe 9/16-18 threads per inch		\$3.50	
37-0471	"T" fitting 3/8-24 3/16 lines each		\$6.99	
Clamp-insulated				
37-0315	3/8 w/ hdw pair		\$3.75	
Rear Axle Division block				
37-0248	secures to diff housing bracket w/ clip to split (3/16) brake lines 1/2 ton NOT 53 & 54	51-66	\$29.95	\$15.00
37-0249	Rear axle block fitting 1/4 line	36-65	\$34.95	
Division Block w/ mount bracket (universal)				
37-0476	3/16 tube 3/8-24 thread		\$29.95	

Bill's Truck Shop

Phone (905) 725-3460 / (905) 725-2022 / Fax (905) 404-2302 email: bill@billstruckshop.com

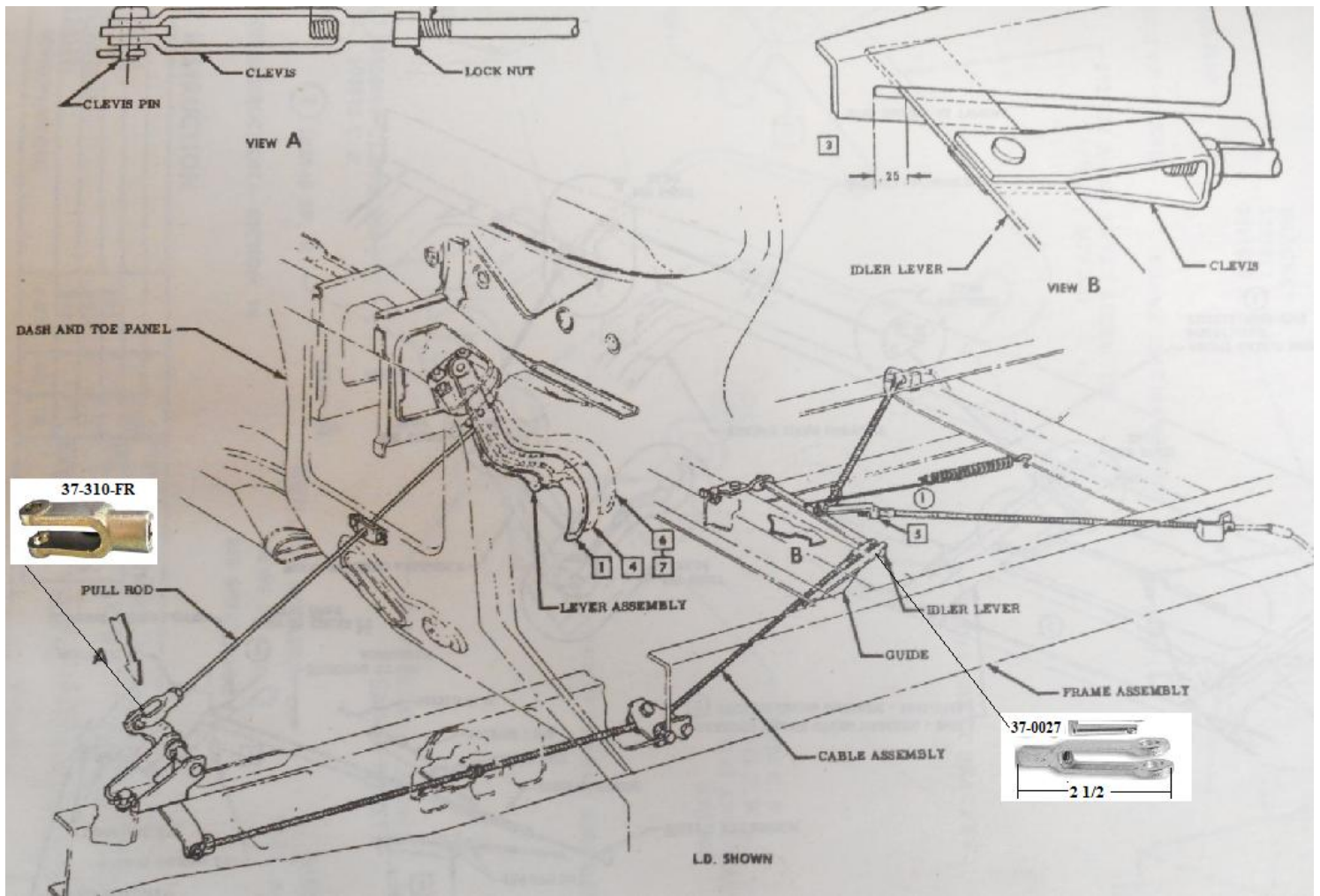

Brakes

Due to the fluctuation of the Canadian and American dollars call for current prices

Group 37

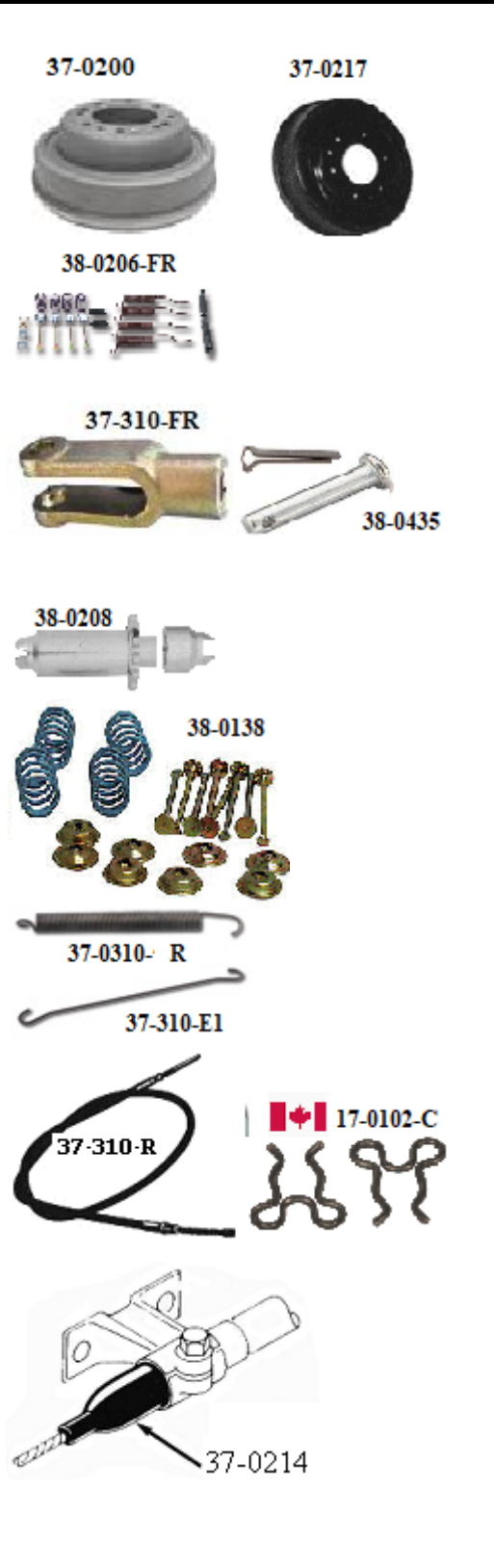

		Year	New	Used
Brake Drum (each)				
37-0217	front or rear ½ ton 11" each	51-70	\$79.95	
37-0200	front brake drum 12 x 2 ¾ and 1 ton	53-62	\$169.95	
Brake Spring Kit -hold down & return per axle				
38-0206-FR	front & rear axle 1/2 ton	51-63	\$18.95	
Brake Shoe Hold Down kit				
38-0138	¾ ton up -w/ 2 ¾ pin 12" shoes and up/ ft and rear per axle	51-87	\$12.95	
Brake Adjuster Screw w/ out self adjusting brakes				
38-0208	L or R front & rear each	51-62	\$16.95	
Parking Brake Cable				
37-310-FS	front shortbed 3100	55-59	\$24.95	
37-310-FL	front longbed 3200	55-59	\$26.95	
37-310-R	rear cable ½ ton	55-59	\$44.95	
37-310-R-B	w/Dana rear end-bolts to backing plate Total length approx. 64 / casing length approx. 32	55-59	\$69.95	
Park Brake Return Spring				
37-0310-R	spring w/ rod-locates @ center frame support-			
55-59	1/2 ton, 58-59 4x4	55-65	\$11.95	
37-310-E1	6 ft short bed extension	55-59	\$4.75	
37-310-E2	8 ft extension	55-59		Inquire
Yoke-Parking Brake Rod Clevis				
37-0027	cable end at frame pivot 5/16 NF w/pin	55-59	\$9.95	
37-310-FR	@ rod end at frame pivot	55-59	\$14.95	
-----	@ at front of park rod & frame bkt			
Pin-cable yoke end				
38-0435	5 /16 x 1 1/4	47-55	\$1.45	
Parking Brake Cable Reducer				
17-0500A	adjustable to reduce length of cable- each		\$9.00	
Parking Brake Cable Boot				
37-0214	each	47-59	\$5.95	
Park Brake Cable Retainer				
17-0102-C	OE wire style pair	55-87	\$5.95	

Bill's Truck Shop

Phone (905) 725-3460 / (905) 725-2022 / Fax (905) 404-2302 email: bill@billstruckshop.com

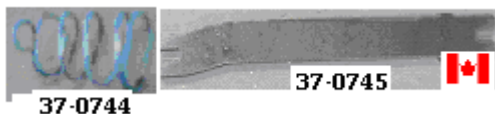

37-0744

37-0745



38-0208



38-0138

38-0206-FR



17-0701

17-0702

17-0444

17-0444-S



17-0508

17-0507

Brake Spring Kit -hold down & return per axle

38-0206-FR front & rear axle 1/2 ton 51-63 \$15.95

Brake Shoe Hold Down kit

38-0138 3/4 ton up -w/ 2 3/4 pin 12" shoes and up/ ft and rear per axle 51-87 \$12.95

Brake Adjuster Screw w/ out self adjusting brakes-has coarse tooth spacing

38-0208 L or R each 51-62 \$15.95 \$5.00

Park Brake Bar

37-0745 Strut-park brake 1/2-ton approx 7 1/2 long w/ 11 brakes 51-77 \$11.95

Park Brake Bar Spring

37-0744 @ cross bar & front shoe each 51-87 \$3.75

Fits 64-75 1/2-3/4 ton rear 2 and 4 wheel drive, 64 1/2 ton 2 wheel drive front, and 65-75 1/2 ton 2 and 4 wheel drive front.-can use to upgrade to self adjusting brakes from 51-63

17-0508 Brake Adjuster kit w/ 11 brakes L side 64-75 \$29.95

17-0509 Brake Adjuster kit w/ 11 brakes R side 64-75 \$29.95

17-0444 Park brake arm retainer clip w/ tension washer 2 pair /both sides 60-91 \$3.00

17-0444-S 2 Stud- park brake arm to shoe w/washer & clips \$9.95

17-0444-S These park arms used the stud w/ C clip to secure to the shoe (not the bolt w/nut)

17-0701 Park brake cable arm-left 1/2 ton 64-91 \$34.95

17-0702 Park brake cable arm-right 1/2 ton 64-91 \$34.95

SELF ADJUSTING BRAKES-self adjusting brakes can be applied to any 1951-66 chev 1/2 brakes-add 17-0508 (right) and 17-0509 (left) for front 7 rear

Adjuster arm Spring

Sunvisor each \$1.50

BRAKES



37-318-P



37-318-R



37-318-G

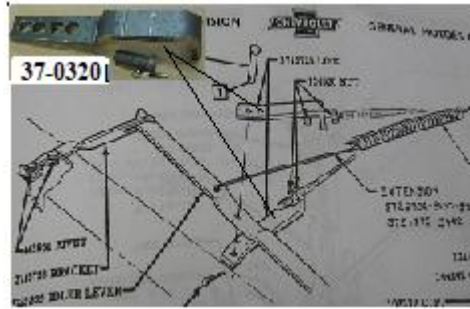

37-0320

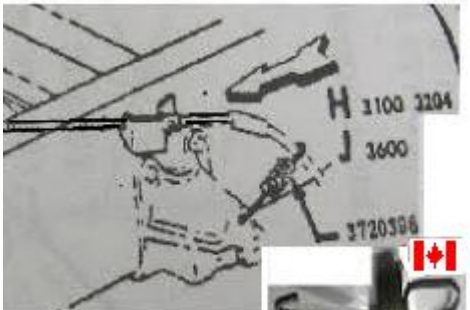

37-310-RS

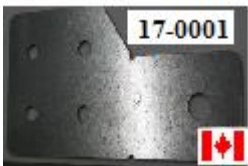

17-0001

Parking Brake Roller

37-318-R nylon cable guide under cab 55-59 \$15.95

Parking Brake Roller Pin

37-318-P special collar bolt 55-59 \$10.95

Parking Brake Cable Hardware Pedal, linkage, etc.

Parking Cable Roller & Bracket

37-318 @ frame for front cable 55-59 \$30.00

Parking cable extension

37-0320 park cable at crossmember fits left & right w/ hdw each 55-59 \$22.95

Parking Brake Cable Hardware Pedal, linkage, etc.

37-319 55-59 Inquire

Grommet-front park cable @ transmission crossmember

37-318-G 55-59 \$2.00

Spring-brake cable

37-310-RS located @ shackle to secure rear cables-each 55-59 \$8.95

Universal Park Cable Support

17-0001 11 gauge galvanized steel-can be used to anchor park cables on frame-bend support to each application-9/16 cable hole-may require enlarging/includes hdw-bend bkt to fit application \$18.95

Bill's Truck Shop

Phone (905) 725-3460 / (905) 725-2022 / Fax (905) 404-2302 email: bill@billstruckshop.com

Front Suspension Parts

Group 38



38-0325-O

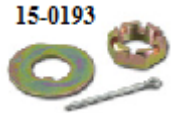

15-0193



38-0326



38-04759-BK

38-04759-S



38-0230-S



38-0230-N



17-0977



38-0250

Backing Plates-brake shoe

			<u>Year</u>	<u>New</u>	<u>Used</u>
37-0325-F	front 1/2 ton	L or R	55-62		\$35.00
37-0325-R	rear 1/2 ton	L or R	55-62		\$50.00

Wheel Bearings Hubs

38-320-H	1/2 or 3/4 ton		55-59		\$50.00
----------	----------------	--	-------	--	---------

Wheel Bearing/Seal Shield

38-0324	between bearing & knuckle	each	55-59		\$5.00
---------	---------------------------	------	-------	--	--------

Wheel Bearings-front

38-0325 -I	inner wheel bearing- ball type-1/2 ton		38-59	\$79.95	\$30.00
38-0325-O	outer wheel bearing-ball type-1/ 2 ton		38-61	\$59.95	\$20.00
38-0325-3I	inner wheel bearing- ball type-3/4 & 1 ton		53-59	\$69.95	\$20.00
38-0325-3O	outer wheel bearing-ball type 3/4 & 1 ton			\$88.50	\$20.00

Dust Shield for inner seal & bearing

38-0303	tin shield & spindle backing plate	each	47-62		\$3.00
---------	------------------------------------	------	-------	--	--------

Grease Seal-front

38-0326	1/ 2 ton 2 whl drive	each	38-59	\$24.95	
38-0669	3/4, 1 and 1-1/2 ton	each	35-59	\$25.95	

38-04759-BK

Wheel Bearings kit-upgrades to tapered roller

bearings w/ grease seals	1/2 ton only		47-59	\$189.95	
--------------------------	--------------	--	-------	----------	--

Wheel Stud

s (each)

38-0230-S	7/16-20 X 1 3/8	each	51-70	\$3.99	
-----------	-----------------	------	-------	--------	--

Wheel Nut

38-0230-N		each	36-70	\$3.50	
-----------	--	------	-------	--------	--

Spindle Nut and Washer

15-0193			47-87	\$14.95	
---------	--	--	-------	---------	--

Spindle Dust Cap

17-0977	approx 2 3/32 " OD	each	47-62	\$9.95	
---------	--------------------	------	-------	--------	--

Backing Plate Plugs







38-0250		each		\$0.85	
---------	--	------	--	--------	--

Bill's Truck Shop

Phone (905) 725-3460 / (905) 725-2022 / Fax (905) 404-2302 email: bill@billstruckshop.com

Frame-Suspension Parts

Group 38

				<u>Year</u>	<u>New</u>	<u>Used</u>
	Spindle checked for king pin size					
	38-330	left or right	1/2 ton each	55-59		\$100.00
	38-330-3/4	left or right	3/4 ton each	55-59		\$100.00
	Front I Beam					
	38-340		1/2 ton	55-59		\$250.00
	38-340-1		3/4 -- 1 ton	55-59		inquire
	Bracket-2 & 3 frame cross member support -each					
	38-345-S	fits L & R w/ hdw	each	55-59		\$34.95
	. For rear leaf spring setups, these items help correct your rear end to driveshaft angle and eliminate vibration during operation at all speeds. Misalignment is common on lowered and lifted vehicles Our axle shims are also an important item when you have added power steering to your vintage straight axle front end. Original straight axle front ends came with minimal caster angle to make steering easier on the driver. When power steering is added, the caster angle must be increased or "road wander" becomes prevalent.					
	Pinon & Caster Angle Shim set					
	39-0004-FR	2 " wide 4 deg w/ bolt-ft	caster or rear pinion angle	47-54		\$52.95
	39-3004	original caster shims 2" wide	pair	55-59		\$10.00
	Leaf Spring					
	39-310-F	1/2 ton	set of 7 pair	55-59	Inquire	\$150.00
	39-310-R	1/2 ton	set of 8 pair	55-59	Inquire	\$150.00
	Main Leaf Spring -replace the main leaf only if bushing eyelets are broken or worn OR if leaf is broken- bushing not included					
	39-310M-F	front	1/2 ton only each	55-59		\$139.95
	39-310M-R	rear	1/2 ton only each	55-59		\$139.95
	Leaf Spring Center Bolt w/nut ----- confirm size					
	39-0211-3/8	3/8 x 7 "	each	47-72		\$5.95
	39-0211-5/16	5/16 x 7 "	each	47-72		\$5.95

Bill's Truck Shop

Phone (905) 725-3460 / (905) 725-2022 / Fax (905) 404-2302 email: bill@billstruckshop.com

Steering & Suspension

Due to the fluctuation of the Canadian and American dollars call for current prices

Group 39

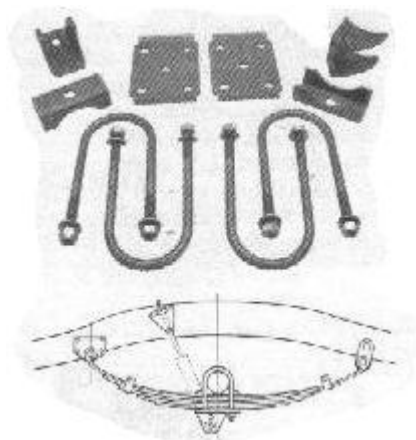

55-59 Rear axle conversion kit- use to update to later model 3" axle tube dia -- eg,F body rear ends

45-3RCK

Year

New

Used

55-59

\$139.95

45-3559-RAS axle seat -- pr

55-59

\$19.95

Bill's Truck Shop

Phone (905) 725-3460 / (905) 725-2022 / Fax (905) 404-2302 email: bill@billstruckshop.com

Steering & Suspension

Due to the fluctuation of the Canadian and American dollars call for current prices

Group 39

			<u>Year</u>	<u>New</u>	<u>Used</u>
		39-0205-P			
					
39-301-FR	39-304-F	39-0206			
					
39-308	39-0227	39-0225			
					
39-0203-S					
					
39-314-55F					
					
39-0218	15-0560-BP				
					
39-316-R	39-316-F				
Shackle Kit -threaded pins, bushings, side plates & seals					
47-56 w/centre pin w/2" spring/57-59 w/ nut on bushing pin					
39-301-FR 47-55 1,1 1/2,2 ton front & 55-56 1/2. 3/4 ton w/2 " spring front and rear			47-56	\$74.95	
39-302-FR -Ft or Rr-1/2 or 3/4 w/ 2'spring			57-59	\$69.95	
Spring Eye Bolt & Bushing at fixed end of spring					
39-304-F front 1/2 -3/4 /threaded nut w/ 2" spring			55-59	\$38.95	
39-304-R rear 1/2- 3/4 w/ notch lock w/ 2"spring			55-59	\$38.95	
Lock Pin -threaded & tapered					
39-0205-P secures rear spring eye bolt			55-59	\$15.95	
Shackle Rubber Seals					
39-0206 each			47-59	\$1.15	
Rear Spring Shackle					
39-0203-S cast iron support w/ new bushing-33-68 3/4 - 1 ton and 33-59 1 1/2 - 2 ton			each	33-68	\$124.95 \$75.00
King Pin Set					
39-308 std size .8660 x 5.312" 1/2 ton			55-59	\$159.95	
39-308-OS oversize .010 1/2 ton			55-59	\$159.95	
39-308-1 std- size diameter .921 3/4 & 1 ton			55-59	\$169.95	
Grease/Zerk Fittings					
39-0227 1/4-28 Pipe Thread 45 degree-each				\$7.90	
39-0225 1/4-28 Pipe Thread-straight----each				\$2.95	
Shock Absorber Cylinder Type (gas) pre check rear shock mount length required -note # of leaf springs ft & rear					
39-314-55F 1/2 - 3/4 ton front 12" closed/19" open					
55-56 Front 1/2, 3/4 & 1 ton			each	55-56	\$43.00
16-0008 1/2 - 3/4 ton front 12" closed/19" open			each	57-59	\$69.95
39-314-57R 1/2 - 3/4 rear 14"closed-23"open 1955-56 1/2 ton Longbed and 3/4 ton 1957-59 1/2 and 3/4 ton			each	55-59	\$89.95
Axle Bumper					
39-0218 47-55rear & 55-59 ft & rear			each	47-59	\$10.95
15-0560-BP universal application axle/frame /control arm bumpers polyurethane 2" tall			pair		\$36.95
U-Bolts w/ hardware					
39-316-F 5" long front w/ 2 " spring			each	55-59	\$14.95
39-316-R 7 1/2 long w/2" spring rear			each	55-59	\$14.95

Bill's Truck Shop

Phone (905) 725-3460 / (905) 725-2022 / Fax (905) 404-2302 email: bill@billstruckshop.com

Steering & Suspension

Due to the fluctuation of the Canadian and American dollars call for current prices

Group 39

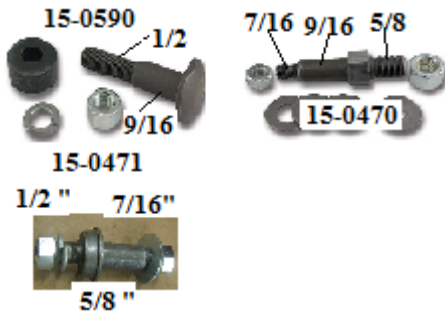

Shock Bolt—check OE hole size

		Year	New	Used
15-0470	universal application	55-59	\$12.95	
15-0590	up & lower rear-- lower front and upper front w/ replacement support	55-59	\$9.50	
15-0471	universal application		\$9.95	



Retainer/guide

39-0316-F	front spring u-bolt	each	55-59		\$5.00
39-0316-R	rear spring u-bolt	each	55-59		\$5.00



 **BTS EXCLUSIVE**



 **BTS exclusive**

Shock Absorber Mount Brackets

39-315-RU	rear upper fits L or R	each	55-59	\$44.95	\$20.00
39-315-RLL	rear lower 2 3/4 high	left	55-57		\$20.00
39-315-RLR	rear lower 2 3/4 high	right	55-57		\$20.00
39-315-RLL-58	rear lower 3 1/2 high	left	58-59		\$20.00
39-315-RLR-58	rear lower 3 1/2 high	right	58-59		\$20.00
39-315-FU	front upper w fits L or R	each			
	MUST add 15-0590 shock bolt		55-59	\$47.95	
39-315-FLL	front lower	left	55-59		\$20.00
39-315-FLR	front lower	right	55-59		\$20.00
39-315-F	ft lower shock bkt-fits L or R	each	55-59	\$34.95	



Bill's Truck Shop

Phone (905) 725-3460 / (905) 725-2022 / Fax (905) 404-2302 email: bill@billstruckshop.com

Steering & Suspension

Due to the fluctuation of the Canadian and American dollars call for current prices

Group 39

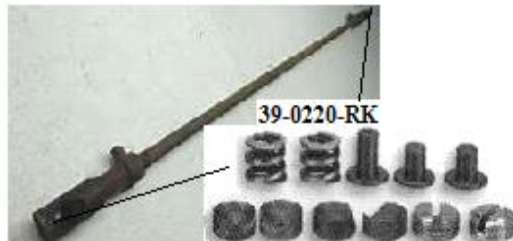
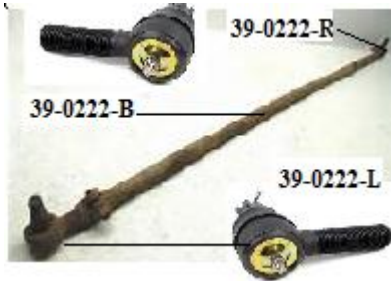
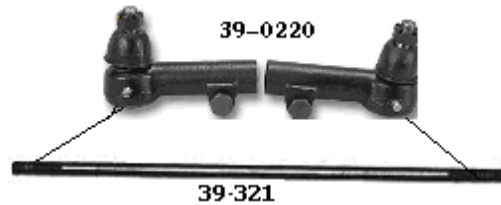

Tie Rod Ends

39-0220 replacement type w/ female threaded ends-1/2 and 3/4 ton w/ solid male style bar pair

Year New Used

47-59 \$99.95

Tie Rod Ends ---- NEW style w/ hollow style female bar

39-0222-L left tie rod end 34-59 \$69.95

39-0222-R right tie rod end 34-59 \$69.95

39-0222-B center hollow bar 47-55 \$40.00

Tie Rod Repair kit and 41-52 drag link

39-0220-RK 1/2 - 3/4 & 1 ton for both sides 29-59 \$42.95

Tie Rod Link -solid bar-threads must be cleaned before installing ends

39-321 threaded male bar between front wheels 55-59 \$69.95 \$30.00

Tie Rod Ends ---- NEW style w/ hollow style w/ female bar 1/2 & 3/4--tapered shaft

39-0222-L left tie rod end 34-59 \$49.95

39-0222-R right tie rod end 34-59 \$49.95

39-0222-B center hollow bar 47-55 \$40.00

39-0035 1 & 1 1/2 ton left 34-59 \$84.95

39-0036 1 & 1 1/2 ton right 34-59 \$84.95

3.38 in Length; with .812 in x 18 Threads

39-0035/6 center bar-need measurement 34-59 \$100.00

Steering Drag Link pitman arm to steering arm

39-323 fits 1/2- 3/4- 1 ton 55-59 \$159.95

Power Steering Custom Drag Link

45-3559-DL custom drag link for 400 series power steering box—adjustable (helps correct steering return on turns)

55-59 \$144.95

Ball Stud @ steering arm for tie rod

39-0225-2 (1/2shoulder) at tie rod end 1/2 ton -each 34-59 \$29.95

39-0225-3 1/2 tapered shaft at tie rod end 3/4 ton - each 46-59 \$39.95

Tie Rod Boot

39-0176 w 9/16 shaft diameter each \$5.95

39-0177 w 5/8 shaft diameter each \$5.95

Bill's Truck Shop

Phone (905) 725-3460 / (905) 725-2022 / Fax (905) 404-2302 email: bill@billstruckshop.com

Steering & Suspension

Due to the fluctuation of the Canadian and American dollars call for current prices

Group 39



		Year	New	Used
Steering Box –used sold as “AS IS “				
Rebuilt columns do not include new upper bearing- #18-0311-confirm if required—includes 5-0230-N Grease packed during assembly-no lube required-tube length- top of box casting to top of tube-OE ratio 24:1				
			Rebuilt	
40-302-55	w / 3 speed column shift	36 1/2 “	55-56	\$395.00 \$150.00
40-302-55-4	w/ 4 speed floor shift	36 1/2	55-56	\$395.00 \$150.00
40-302-57	w / 3 speed column shift	33 1/2 “	57-59	\$395.00 \$150.00
40-302-57-4	w/ 4 speed floor shift	33 1/2		\$395.00 \$150.00
Pitman-Sector Bushing kit				
40-0056	2 brass bushing w/ seal		37-72	\$42.95
Pitman Shaft Nut w/ lock washer				
40-0055-N	w/ manual steering box		37-72	\$4.00
Upper Column Bearing -				
18-0311	with horn wire		47-59	\$84.95 \$35.00
Steering Box Thrust Bearing upper & lower				
40-0790			41-59	\$44.95
Steering Box Rebuild Kit w/ , bushings shims, gaskets & instructions does not include ball bearings				
40-301-1			55-59	\$139.95
Steering Box Bearing set				
40-0001	60 pcs 9/32 steel ball bearings			\$34.95
Steering Box Gasket set				
40-0808	end cap & cover		41-46 & 55-59	\$9.95
Pitman Shaft Seal				
40-0055			37-72	\$21.95
Steering Stabilizer Kit--improves steering --NEW design--anchors at REAR u-bolt of leaf spring & drag link--improve steering ability, Kit includes stabilizer unit and mounting hdw--may require replacing 1 u-bolt (39-216-FR) if it cannot be removed				
40-0207			47-59	\$159.95

Bill's Truck Shop

Phone (905) 725-3460 / (905) 725-2022 / Fax (905) 404-2302 email: bill@billstruckshop.com

Mounts & Hardware

Due to the fluctuation of the Canadian and American dollars call for current prices

Group 40

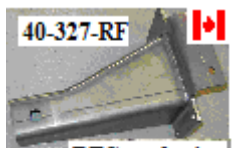
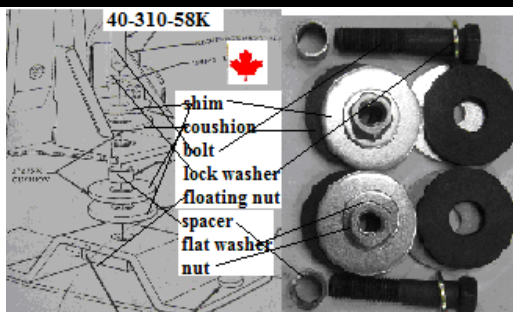

BTS exclusive

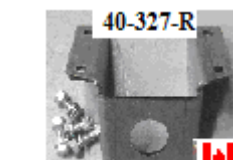

BTS exclusive



40-0312-G



			<u>Year</u>	<u>New</u>	<u>Used</u>
Radiator Support Mounting Pads					
40-310	Chev	set of 4	55-59	\$6.95	
Radiator Support Mount kit-includes bolts & cushions, washers					
40-310-55K			55-57	\$29.95	
40-310-58K	secures to square floating nut under stand-includes extra flat washer & lock nut if floating cage nut is missing or damaged		58-59	\$34.95	
Cab Mount Kit With hardware					
40-327		pickup	55-59	\$49.95	
40-327-1		panel or suburban	55-59	\$79.95	
Cab Frame Support w/ hdw					
40-327-LF		left front	55-59	\$149.95	
40-327-RF		right front	55-59	\$149.95	
40-327-R		left or right rear each	55-59	\$69.95	
Front Motor Mounts					
40-312-S		small cushion each	55-59	\$3.95	
40-312-L		large cushion each	55-59	\$3.95	
40-312-K		kit-8pcs	55-59	\$32.95	
40-312-CHK		4 outer washer w/ nuts & external tooth lock washers 8 pcs per side	55-59	\$7.95	
40-312-SV8		Engine mount stud w/V8 each	55-59	\$24.95	
40-312-6		upper engine support 6 cyl pr	55-59		Inquire
40-312-8		upper engine support V8 pair	55-59	\$44.95	
40-0312-G		8 cyl GMC front 1-up & 1 lower	55-59	\$99.00	
V8 Conversion Kit					
40-3V8		original style to install v-eight engine	55-59	\$259.95	
40-3V8-HK		correct bolts/ washers to install	55-59	\$15.95	

Bill's Truck Shop

Phone (905) 725-3460 / (905) 725-2022 / Fax (905) 404-2302 email: bill@billstruckshop.com

Mounts & Hardware

Due to the fluctuation of the Canadian and American dollars call for current prices

Group 40

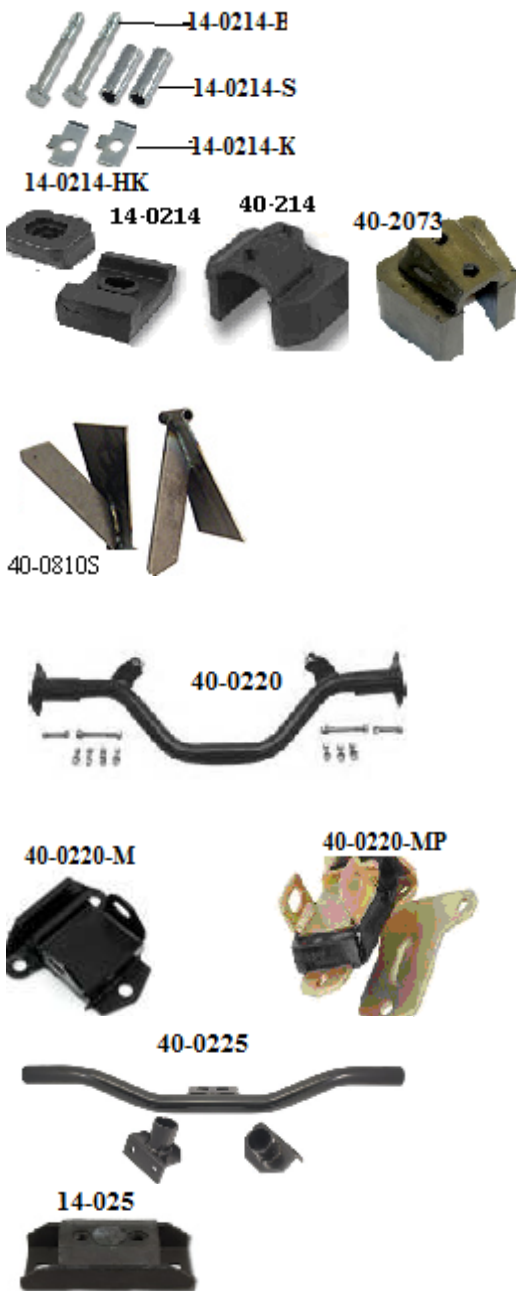

Rear Mount hdw

			<u>Year</u>	<u>New</u>	<u>Used</u>
14-0214-K	keeper to secure through bolt-each		54-59	\$8.95	
14-0214-S	mount bolt spacer	-each	54-72	\$10.95	
14-0214-B	mount bolt	-each	54-72	\$2.00	

Motor Mount Install hdw kit

14-0214-HK	sleeves/bolts & locks	6 pcs	2 sides	54-59	\$26.95
------------	-----------------------	-------	---------	-------	---------

Rear Motor Mounts

14-0214	1 upper & 1 lower- also	54-59 aut trans	54-87	\$32.95	
---------	-------------------------	-----------------	-------	---------	--

40-2073	1937-1947 Chevrolet),(1939-1959 GMC) (1947-1953, 3/4, 1, 1 1/2, 2 ton Chevrolet and GMC).(1952 -1953 GMC with Hydromantic Trans (wedge shape-3 " wide)	each	37-59	\$29.95	
---------	--	------	-------	---------	--

V8 Engine Frame bkts. Set-big & small block

40-0810S	weld to frame when installing Mustang II front suspension/ universal application-requires mount # 40-0220-M		47-59	\$109.95	
----------	---	--	-------	----------	--

V8 Crossmember Adapts GM small block motors to early frames w/ hardware

40-0220			47-59	\$94.95	
---------	--	--	-------	---------	--

V8 Motor Mount -----use w/ V8 kit 40-0220 & 40-0810S

40-0220-M	OE rubber	each	47-59	\$21.95	
40-0220-MP	Polyurethane, Zinc/Black	each	47-59	\$64.95	

Transmission Crossmember Use to install standard or automatic trans.

40-0225			54-72	\$109.95	
---------	--	--	-------	----------	--

Rear Transmission Mount Pad

14-025	use with std / PG / 350/700 trans			\$24.95	
14-025-1	turbo 400			\$24.95	

Bill's Truck Shop

Phone (905) 725-3460 / (905) 725-2022 / Fax (905) 404-2302 email: bill@billstruckshop.com

Engine – Rear Axle-Trans

Group 41



41-0695

41-0788

41-0970



41-0055-K



41-0502-EL

41-0016



41-0410



41-0910



41-0225



41-0225-G



Inquire about used rear ends 1/2 - 3/4 and gear ratio

\$250.00

Axle Seals-rear

41-0695	1/2 ton each	38-62	\$39.95
41-081B	3/4 - 1 ton w/ out Dana rear axle-dana rear axle cover has straight sides-other axle has round cover	47-72	\$24.95

Rear Axle Rebuild kit-includes ft & rear pinion bearing w/ crush sleeve, pinion seal and 2 carrier side bearings, also includes gasket/cover is 10 bolt cover

41-0055-K		55-62	\$299.95
-----------	--	-------	----------

Rear Axle Bearings

41-0502-EL	outer 1/2 ton each	38-61	\$92.95
41-0503	outer bearing 3/4 and 1 ton	46-72	\$49.95
41-0504	inner axle bearing 3/4 and 1 ton	46-72	\$49.50

Pinion Nut

41-0016	7/8-16 thread- 1 1/8 OD		\$24.95
---------	-------------------------	--	---------

Pinion Seal

41-0788	1/2 ton w/ common spicer 44 rear end	55-62	\$47.95
41-0970	3/4 - 1/ ton- 1 1/2 ton- w/ open drive shaft	46-65	\$40.95

Pinion Bearing—spicer 44

41-01047

Pinion Bearing

41-0910	rear	55-62	\$89.95
41-0410	front	55-62	\$74.95

Rear Axles 1/2 ton / inquire about 3/4-1 ton

41-3500-L	17 spline left 30 1/8 long	55-59	\$175.00
41-3500-R	17 spline right 31 long	55-59	\$175.00

Rear Axle Plug

41-0225	1" w /gasket	47-63	\$19.95
41-0225-G	gasket (leather)	47-63	44.95

Bill's Truck Shop

Phone (905) 725-3460 / (905) 725-2022 / Fax (905) 404-2302 email: bill@billstruckshop.com

Engine – Rear Axle-Trans

Group 41

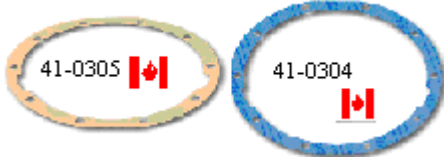

Inquire about used rear ends 1/2 - 3/4 and gear ratio

Rear Axle Cover Gasket

41-0304	1/2 - 3/4 10 bolt rear end	37-63 Chev		
	39-66 GMC 1/2 ton	1/16 (.063) thick	37-66	\$7.95
41-0088	3/4 - 1 - 1 1/2	H072-52 Eaton w/ 10 bolt cover	37-72	\$21.95

Rear Differential Carrier Gasket

41-0305	1/2 - 10 bolt rear end	37-63 & 37-45		
3/4 ton	39-70 1/2 GMC	1/32 (.031) th	37-63	\$7.95

Rear Axle Vent @ some trans

16-0270	plastic w/ cover	64-72	\$4.95
16-0271	metal screw in	47-63	\$24.95
16-0270-K	rear axle vent w/ hose	60-87	\$11.95

Rear End Gear Kit raise your top speed

41-0338	upgrade from 3.90 to 3.38 to 1 ratio ring and pinion, 1/2 ton- we suggest you add rebuild kit # 41-0055-K requires crown/carrier # 3697701	55-62	Inquire
Inquire	-Used CHEV 3:90 rear carrier assembly 1/2	55-69	\$250.00

TOOL

41-0TOOL pair of carrier adjust wrenches- available to borrow w/ return Inquire

Sleeve-rear pinion crush/non posit

41-0151		55-66	\$24.95
41-0152	1/2 w/ 8:75 rear end	66-81	\$16.50
41-0305	1/2 - 10 bolt rear end	37-63 & 37-45	
3/4 ton	39-70 1/2 GMC	1/32 (.031) thick	37-63 \$5.95

Bill's Truck Shop

Phone (905) 725-3460 / (905) 725-2022 / Fax (905) 404-2302 email: bill@billstruckshop.com

Dana-Spicer 45

GMC trucks used Dana rears for many of the same applications where Chevy had Eaton. AFAIK, those Danas are a direct swap into Chevy trucks- the Dana has more highway-friendlier gearing.

Apart from the expected parts differences, the Dana also uses different brake drums.

Spicer/Dana 44 rear axles are identified by a casting number stamped into the webbing on the front of the differential case to the driver's side of the driveshaft. Front axles have a model number cast just below where the right-side axle tube connects to the differential. On this same axle tube, you will find a build date and a bill of materials number stamped into the body of the tube. This bill of materials number is important for ordering replacement parts and identifying what the differential originally came out of. The number will be six digits long with a seventh number after a dash. The last digit identifies the ring and pinion ratio at the time of production. A complete list of the bill of materials numbers for both Dana 44s and Dana 60s is available on the parts locator

Chevys had the 3.90 rear gears; GMCs had the 3.91 (or 3.92?) gears.

First figure out what rear end you have. Chevy rear end is the HO33 it has a round, removable rear cover, AND a drop out center section.

The GMC should have a Spicer/Dana 45 which has a removable rear cover, and you can't take the pumpkin out. The cover is shaped kind of like a stop sign.

1955-59 1/2 Chev rear end



Inquire about used rear ends 1/2 - 3/4 and gear ratio

DANA REAR ENDS

Axle Seals-rear

Rear Axle Bearings

Pinion Seal

Rear Axle Cover Gasket

Rear Differential Carrier Gasket

Rear Axle Plug

Rear Axle Vent

Bill's Truck Shop

Phone (905) 725-3460 / (905) 725-2022 / Fax (905) 404-2302 email: bill@billstruckshop.com

TRANSMISSION

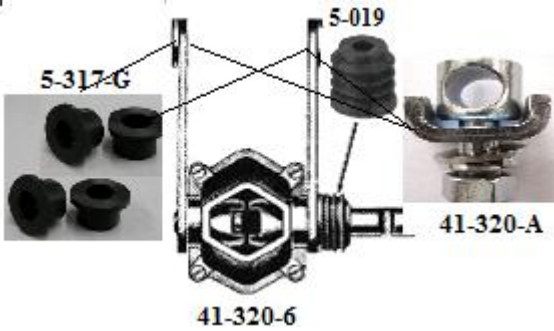

Shift Linkage Adjuster

41-320-A each 55-59 \$18.95

Shift Box

41-320-6 6 cyl 55-59 \$50.00

41-320-8 8 cyl 55-59 \$50.00

Shift Rod Grommet @ box & trans

5-317-G set of 4-rubber 55-59 \$6.50

Shifter Boot at shift box

5-019 47-59 \$3.95

Inquire about used trans and trans parts-
shift linkage etc.

Transmission-gear speedometer

41-0000 inquire - most 4 speed and
of teeth screws into tailstock \$25.00

41-0000-1 2 5/8 long secures w/ lock tab \$20.00

41-0200 1 7/8 " long secures w/ lock tab \$39.95

63-87-- 350 aut -2 speed powerglide & some 3-4
speed Saginaw transmission speedometer driven
gear-less teeth to increase odometer MPH 63 up
2" long & 62 and under 3" long

3 & 4 speed std-power glide/350

41-0221-18 Speedo driven gear-brown
w/ 18 teeth \$12.95

41-0221-19 Speedo driven gear- white
w/19 teeth \$12.95

41-0221-20 Speedo driven gear-dark
blue w/20 teeth \$12.95

41-0221-21 Speedo driven gear-red
w/21 teeth \$12.95

41-0221-22 Speedo driven gear-green
w/22 teeth \$12.95

41-0221-24 Speedo driven gear-yellow
w/24 teeth \$12.95

41-0221-25 Speedo driven gear-natural
w/25 teeth \$12.95

Retainer-Speedo drive gear-350-400-460 \$9.00

41-0222-20 Speedo gear-metal 3 " long
w/ 20 teeth inquire about others \$20.00

Bill's Truck Shop

Phone (905) 725-3460 / (905) 725-2022 / Fax (905) 404-2302 email: bill@billstruckshop.com

TRANSMISSION

41-0SM420-TS SM420 4 speed trans



41-03305



The SM-420 4-speed transmission was produced by General Motors between the years of 1947 & 1967. Starting in 1966 General Motors offered the NP-435GA for its light truck applications as an option. The NP-435-GA became the standard 4-speed sometime in the late 1960s. The cast iron case with large bulge on the passenger side makes the SM-420 easy to identify. Ribbing was added to the bulge on later cases. The ribbed SM-420 case should not be confused with the later SM-465 transmission. How can you tell which 4-speed your 1966 has, if reverse is to the driver & down, it's the SM-420, if to the passenger & down

SM420 4 speed transmission parts

Tailstock/rear yoke seal

41-0SM420-TS		47-67	\$38.95
--------------	--	-------	---------

Bearings-transmission

41-03305	main shaft rear ---3 speed	37-54	\$69.95
----------	----------------------------	-------	---------

41-03207	ft input bearing---3 speed	38-67	\$62.95
----------	----------------------------	-------	---------

Bill's Truck Shop

Phone (905) 725-3460 / (905) 725-2022 / Fax (905) 404-2302 email: bill@billstruckshop.com

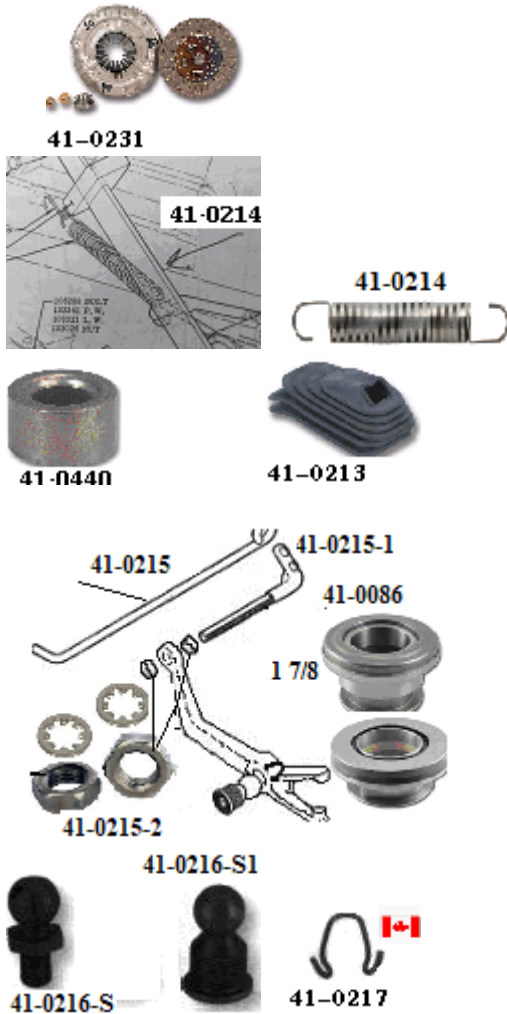

Clutch---match w/ removed parts

41-0231 NEW 10 1/2" clutch w/ pressure plate release bearing. pilot bushing all w/ 3 speed transmission includes 1 7/8 bearing
 41-0072 NEW 11 clutch kit w/ 4 speed trans - Spline: dia 1 1/8 w/ 10 spline includes 1 7/8 bearing,,bushing & align tool

Year New Used

54-62 \$325.95

51-62 \$239.95

Clutch Release Bearing

41-0086 6 cyl & most V8 1 7/8 long
 41-0087 1 1/4 long

38-75 \$79.95

47-84 \$64.95

Clutch Fork Boot-replacement type for newer style

bell housing

41-0213

63-72 \$14.50

41-0213-A original style w/ spring retainer

47-59

inquire

Pilot Bushing

41-0440 brass- fits 6 & 8 cyl

47-87 \$19.95

Clutch Pedal Return Spring @ clutch offset rod

41-0214

47-59 \$5.95

Clutch Linkage Rod

41-0215

47-59 \$17.95

Clutch Linkage Offset Rod

41-0215-1 includes 2 adj nuts

47-72 \$27.95

\$10.00

Nuts-Jam nut for clutch adjust rod-pr

41-0215-2 pair of adjusting nuts w/ washers

47-59 \$3.50

Clutch Fork

41-0218-F

47-59

\$15.00

Clutch Fork Ball Stud

41-0216-S 3/8" stud-6 cyl only

38-59 \$15.95

\$5.00

41-0216-S1 3/4" shaft-V8 only

55-72

\$22.85

\$5.00

Clutch Fork Stud Retainer Clip

41-0217

38-72

\$14.95

Flywheel

41-0409 6 cyl engine (casting # 3705409)
 1955-'62 cars and trucks with 10 1/2-inch clutch and 168-tooth ring gear---used flywheels are resurfaced

55-62

\$175.00

41-00410 6 cyl engine (casting # 3709410 & 3789730) 1955-'62 cars and trucks with 11-inch clutch and 168-tooth ring gear---used flywheels are resurfaced w/ 4 speed trans

55-62

\$175.00

Bill's Truck Shop

Phone (905) 725-3460 / (905) 725-2022 / Fax (905) 404-2302 email: bill@billstruckshop.com



Automatic Column Shift Linkage kit

3-0TSL-L universal-upgrading to auto trans 47-72 \$114.95

Bell Housing

41-3BH 3 & 4 speed trans 55-59 \$40.00

Flywheel Cover-front upper

36-0908 3 & 4 speed trans 55-72 \$44.95 \$20.00

Flywheel Cover-lower

41-0477 3 & 4 speed 55-72 \$87.95 \$30.00

U-joint Retainer

41-0021 1 3/8 center to center each \$10.95

41-0022 1 1/2 center to center each \$10.95

41-0023 1 3/4 center to center-metric each \$11.95

Driveshaft U-joint

41-0369 U-joint w/ 3 speed or automatic 1/2 ton each 55-87 \$39.95

41-0331 U-joint w/ 4 speed @ trans (3 5/8 dia w/ 1 3/16 cup) each 55-87 \$36.95

Driveshaft Hanger Bearing Assembly

14-030-S 1.3780" ID 54-94 \$71.95

54-94 Support Driveshaft hanger bearing w/ side to side mount

Bill's Truck Shop

Phone (905) 725-3460 / (905) 725-2022 / Fax (905) 404-2302 email: bill@billstruckshop.com

Engine

Group 41



			<u>Year</u>	<u>New</u>	<u>Used</u>
Carburetor					
41-0231-54	Rochester	2 15/16 stud spacing	54-59	\$295.00	\$50.00
41-3V8	rebuilt	v8 carburetor Chev ---\$60.00			
	core charge	when core	55-59	NLA	
41-3V8-C		core charge for above carb	55-59	\$60.00	
Carburetor Insulation Plate					
41-0231-1		-2 15/16 mount	54-62	\$11.95	
Carburetor Insulation Plate Gasket					
41-0231-G		-2 15/16 mount	54-62	\$3.95	
Carburetor Rebuild kit -includes gaskets, accel pump, needle w/ seat & instructions NO float					
41-0158	Rochester	6 cyl	50-62	\$47.95	
Carburetor Float					
41-0095	Rochester	w/ 6 cyl	41-62	\$34.95	
Distributor Vacuum Advance					
41-0DVA		6 cyl	37-62	\$64.95	
Oil Filter Assembly w/ bkt					
41-0201-A		6cyl	47-62		\$75.00
Oil Filter Lines (pair)					
41-0249L		6 cyl	47-62	\$64.95	
Oil Line Block kit - 4 pc set					
41-0249-A	2 outlet plug	for oil gauge and filter line-screws in block	47-62	\$19.95	
41-0249-1	1/8 pilot nut			\$2.35	
41-0249-2	1/8 tube OD x 1/8 male pipe			\$4.70	
41-0249-3	1/8 NPT 3 outlet female			\$4.95	
41-0249-4	1/8 x 1" connector tube			\$2.35	
Cartridge Oil Filter The Fram cannisters use a 7/8" wrench on the top bolt and have a crimped bottom/ black top & orange canister-fram # C4 or C4P2 The A/C cannister uses a 5/8" wrench on the top bolt and has a smooth bottom.					
41-0201-1	4 1/8 W x 5 H	FRAM	37-62	\$29.95	
41-0201-2	4 1/2 W x 5 H	AC	37-62	\$23.65	
41-0201-GMC	3 1/2 x 3 7/8 H	GMC ONLY	39-59	\$22.95	
	located on right ft of	6 cyl engine			
Oil Filter Adaptor					
41-0461	early SB V8	--- to convert from cannister filter to spin	56-68	\$69.95	

Inquire

Bill's Truck Shop

Phone (905) 725-3460 / (905) 725-2022 / Fax (905) 404-2302 email: bill@billstruckshop.com

Engine

Group 41



Accelerator Return Spring				
41-0208	6cyl	50-59	\$8.95	
V8 Throttle Linkage original type				
41-0310	47-52 requires 55-57 gas pedal	47-59	\$89.95	
Starter Pedal Return Spring				
41-0211	6 cyl	47-59	\$5.50	
Starter Linkage at bell housing 6 cyl				
41-0212		50-59		Inquire
Spring-Starter pedal return				
41-0211		47-59	\$4.50	
Link-Starter pedal return				
41-0211-L		47-59		
Rod-Starter pedal @ starter				
41-0211-R		47-59		
Tension spring kit-starter pedal rod				
41-0211-K		47-59	\$2.95	
Dip Stick w/ tube				
41-0299	v8 small block OE design-STEEL always confirm correct amount of oil to stick marks	58-74	\$34.95	
Clips-vac & fuel				
41-0195	3 pcs set secures dist vac line to fuel line	37-62	\$12.95	
Cam Gear-fibre type				
41-0500	Cam Gear-216/228/235/248/270	42-62	\$84.95	

Bill's Truck Shop

Phone (905) 725-3460 / (905) 725-2022 / Fax (905) 404-2302 email: bill@billstruckshop.com

41-3VC-G



41-020.B



41-020F-1



41-3 AC-2



41-3AC-3



41-020A



41-3AC-4



41-0201-49

41-0201-54

41-0741



41-0301-55

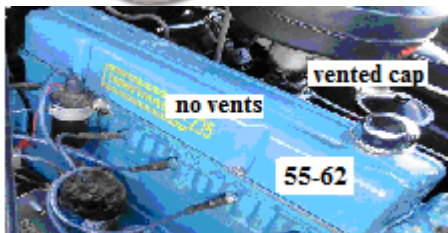

Oil Filter Decals

41-020F-1 W/ Fram type -- 6 cyl engine
 41-030F-2 55-62 A/C type w/ 6 cyl & 1955
 V8 w/ remote filter

Year New Used

47-59 \$9.95

47-62 \$8.95

Generator Warning tag

41-0GT 47-59 \$2.95

Engine Decals Valve Cover

41-3VC-C Chev 6 cyl new-Thrift master 55-59 \$10.95

41-3VC-G GMC---orange details 55-59 \$9.95

41-3VC-GV8 GMC V 8 pair---yellow details 55-59 \$16.95

Air Cleaner Decals

41-020B dry element style 47-59 \$2.95

41-020A oil bath type / angle style top -AC heavy duty 47-59 \$4.95

41-3AC-2 oil bath style w/ 6 cyl 55-60 \$7.95

41-3AC-3 oil bath style w/ 8 cyl w/ 2 bl 55-59 \$7.95

41-3AC-4 v8 w/ 2 bl carb 55-60 \$2.95

Air Breather Wing Nut

41-0741 1/4 x 20 40-66 \$0.75

41-0741-10 #10 x 32 40-66 \$1.95

Oil Filler Cap

41-0201-49 on valve cover -twist on-not vented 49-78 \$7.50

Check valve cover for vent slots -use non vented cap if cover has vents slots & vented cap w/ no vent slots in cover

41-0201-54 6 cyl 54-67 \$10.95

41-0301-55 8 cyl 55-72 \$11.95

Valve Cover

6 cyl w/ Chevrolet embossed 55-62 Inquire

Bill's Truck Shop

Phone (905) 725-3460 / (905) 725-2022 / Fax (905) 404-2302 email: bill@billstruckshop.com

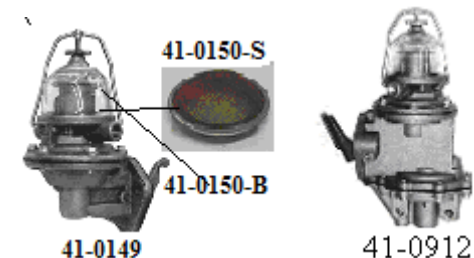
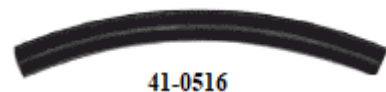

Gas Filter Assembly-OE GM option

41-0668 glass bowl w/ filter -mount at carb 40-62 \$37.95 \$15.00

Gas Filter Fitting hdw kit- installing at carb

41-0668-H 1 x 1/2 pipe—1 x straight -- 1x 90 deg line adaptor—for straight or side pipe install 40-62 \$19.95

Gas Filter

41-0668-F filter for glass assembly 40-62 \$8.95

Gas Filter Gasket

41-0668-G neoprene seal for glass bowl 40-62 \$5.50

Fuel Hose

41-0516 5/16 neoprene hose ----per foot \$3.49

41-038 3/8 neoprene hose ----per foot \$3.49

Fuel Pump

41-0149 w/ glass bowl type- 6 cyl 37-57 \$179.95

41-0429 w/o glass bowl 37-62 Chev/39-59 GMC when using this pump there should be a filter assembly @ carb #41-0668-also may require upper dis to line up pipe in and outlet holes OE style 37-62 \$119.95

41-0429-R w/o glass bowl 37-62 Chev/39-59 GMC when using this pump there should be a filter assembly @ carb #41-0668—this is a newer replacement style 37-62 \$74.95

41-0912 vac/fuel pump combination 39-59 GMC & 37-62 Chev 37-62 \$159.95

41-0005 vac/fuel combination-6cyl 58-62 \$115.00

41-0006 261-GMC & 235 -6 cyl w/ electric wipers 58-62 \$67.95

Fuel Pump Rebuild kit

41-0149-RK glass bowl AC fuel pump 37-62 \$139.95

Fuel Pump Bowl-glass

41-0150-B 41-62 \$10.00

Fuel Pump Bowl-screen

41-0150-S brass inlet filter in bowl 41-62 \$10.00

Fuel Pump Fitting-in and out let pipe

41-0148---fitting 1/8 NPT male x 5/16 tube OD \$3.25

Engine-Trans Gaskets

Due to the fluctuation of the Canadian and American dollars call for current prices

Group 41



Transmission Gasket Set

41-03TG-3 3 speed Muncie 318
 41-02TG-4 39-72 SM420 & 48-65 Muncie 4-speed

Transmission Tailstock Seal w/ Bushing

41-0054
 Tailstock seal
 41-0041

Year New Used

55-66 \$44.95

39-72 \$29.95

55-72 \$42.95

Rear Axle Cover Gasket

41-0304 1/2 - 3/4 10 bolt rear end 37-63 Chev
 39-66 GMC 1/2 ton 1/16 (.063) thick

37-66 \$6.95

Rear Differential Carrier Gasket

41-0305 1/2 - 10 bolt rear end 37-63 & 37-45
 3/4 ton 39-70 1/2 GMC 1/32 (.031) thick

37-63 \$5.95

Bill's Truck Shop

Phone (905) 725-3460 / (905) 725-2022 / Fax (905) 404-2302 email: bill@billstruckshop.com











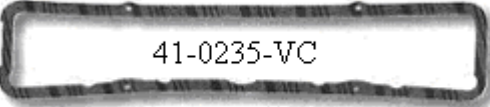

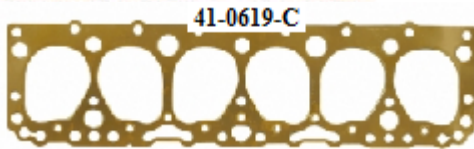
SM318 Muncie transmission

Engine-Trans Gaskets

Due to the fluctuation of the Canadian and American dollars call for current prices

Group 41

		<u>Year</u>	<u>New</u>	<u>Used</u>
	Oil Pan Gasket set			
41-0PG-55	41-0PG-55 235 engine	55-62	\$46.95	
	Valve Cover Gasket			
41-0235-VC	41-0235-VC 216-235 w/ side mount bolts	53-62	\$34.95	
	41-0228-VC 228/236/248/270/302 GMC 6 cyl	39-62	\$39.95	
	Side Cover Gasket			
41-0235-SC	41-0235-SC 216-235 engine- push rod cover	53-62	\$24.95	
	41-0228-SC GMC 228/236/248 6 cyl	39-62	\$25.95	
	Intake Manifold Alignment Sleeves			
41-0619-C	41-0205 34-53 207 & 216 Chev CI engine/41-49 235 Chev engine / 39-59 GMC engine	34-59	\$14.95	
	41-0205-1 235 & 261 CI Chev engine	50-62	\$16.95	
	Intake-Exhaust Manifold to Cyl Head set			
41-0930 41-0075 41-0069-53	41-0185 includes between intake & exhaust ,pipe to manifold etc 235 engine	50-62	\$38.95	
	Head Gasket 235 6 cyl engine			
41-0619-C	41-0619-C NEW copper style-re-torque after running	53-63	\$84.95	
	41-0619	53-63		
	Thermostat Gasket			
41-0930	41-0930 all 6 or 8 cyl		\$3.95	
	Thermostat Housing to Block Gasket			
41-0068	41-0068 216--235	37-62	\$3.50	
	41-0235-SC 216-235 engine- push rod cover	53-62	\$17.95	
	Water Pump to Block Gasket			
41-0069-53	41-0069-53	53-62	\$5.95	
	Rear Main Seal-upgrade/neoprene			
41-02RM-B	41-02RM-B OE rope style	40-62	\$19.95	
	41-0363 replaces the OE rope seal 235-261 6 cyl	55-62	\$89.95	
	41-0711 replaces the OE rope seal 265-283 V8	55-58	\$39.95	
	Timing Cover Gasket set 228/236/248/270-52-59-302			
41-0114-TC	41-0114-TC includes fit crank seal (1pc)	37-62	\$59.95	
	Timing Cover Crank Seal			
41-0842	41-0842 1 pc	37-62	\$27.95	
	Balancer Repair kit			
41-0919	41-0919 corrects groove-sleeve 6 cyl-SB v8	47-87	\$29.95	
	Fuel Pump Gasket			
41-0075	41-0075 6 & 8 cyl		\$3.00	
	Push Rods 235 6 cyl			
41-0031	41-0031 10.444 Inch long set of 4	54-62		

Bill's Truck Shop

Phone (905) 725-3460 / (905) 725-2022 / Fax (905) 404-2302 email: bill@billstruckshop.com

Exhaust

Due to the fluctuation of the Canadian and American dollars call for current prices

Group 41

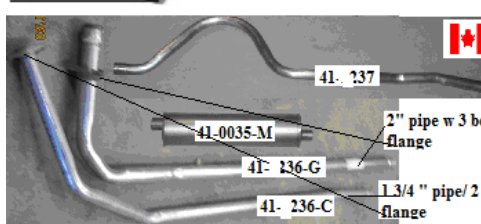
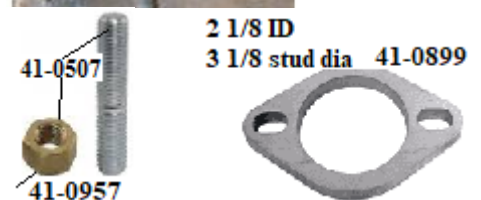

Exhaust to Intake bolt kit

41-0401 2 bolts (1 ¼) & 2 studs (3 ¼) w/ hdw

Exhaust pipe to manifold stud

41-0507 one stud (2 ½ long) w/ deep brass nut --each

41-0957 3/8 – 16 brass nut pr

Heat Riser Spring

41-0206 6cyl

Heat Riser Gasket SB-V8

36-0350-G

Exhaust Gasket-donut

41-0400 6 cyl ft pipe to manifold 2" ID

Exhaust Clamp

41-0134 1 3/4

41-0200 2 00

41-0218 2 1/8

41-0025 2 1/4

Exhaust Flange

41-0899 3 1/8 center to center on stud

Muffler Strap w/ hook

41-0235-SH

Tailpipe Hanger

41-0135

Universal Exhaust Hanger

41-0103

Front Pipe—for short bed –see ext for long bed

2" pipe 6 cyl Chev w/ 2 hole flange

2" pipe 6 cyl GMC w/ 3 hole flange

Tailpipe

1 ½ pipe 6 cyl Chev & GMC w/ turn down end to exit below rear bumper –short step

1 ½ pipe 6 cyl Chev & GMC w/ turn down end to exit below rear bumper –long step

Muffler

41-0035-M 21"L x 5"W 2" inlet & 1 ½ outlet

Year New Used

\$9.95

\$9.80

4.95

\$32.95

\$3.95

\$5.95

\$2.00

\$3.30

\$3.30

\$4.45

\$15.95

\$13.95

\$18.95

\$17.50

Coming \$118.95

Coming \$149.95

Coming \$109.95

Coming Inquire

40-59 \$89.95

Bill's Truck Shop

Phone (905) 725-3460 / (905) 725-2022 / Fax (905) 404-2302 email: bill@billstruckshop.com

Engine – Cooling System

Group 41

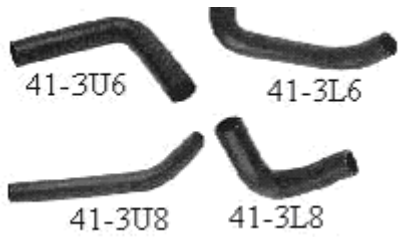

		<u>Year</u>	<u>New</u>	<u>Used</u>
Radiator Hoses- moulded hoses-235 6 cyl				
41-3U6	upper 1 1/2 size Chev w/ 6 cyl	55-59	\$29.95	
41-3L6	lower 1 3/4 Chev w/ 6 cyl	55-59	\$42.95	
41-3U8	upper 1 1/2 size Chev w/ 8 cyl	55-59	\$39.95	
41-3L8	lower Chev w/ 8 cyl	55-59	\$39.95	
41-02HU-B	upper 1 1/4 248/270 GMC w/ 6 cyl	55-59	\$22.95	
41-3L6-G	lower 248/270 GMC w/ 6 cyl	55-59	\$45.95	



Heater Hose –approx 3.5 to 4 ft required to secure on inner fender-MOST heater hoses are 3/4-CONFIRM				
18-0401	5/8 black-per foot		\$2.00	
18-0402	3/4 black-per foot		\$2.00	



Heater Hose Retainer w/ screw				
22-0205	original used- on pass inner fender	40-59	\$21.95	\$10.00
22-0205-1	heater or acc AC line retainer	40-87	\$5.00	

Heater Hose Clamps				
41-0220	1 1/2 “-1 3/4 screw type	each	\$0.95	
41-0220-0	up to 1 “ flat	each	\$3.25	

Radiator Hose Clamps OE style screw clamps				
41-001-3/4	OE style upper 1 3/4	each	\$6.95	
41-002-0	OE style lower 2”	each	\$7.95	
41-0220	1 1/2 - 2” screw type			
41-0228	1 3/4”-2” wrap- screw type	each	\$2.50	
41-004-3	2 1/16 – 2 1/4 OE style		\$7.95	
41-0044	2 1/16 – 2 1/4 wrap screw type			

Radiator Cap				
41-0RC-7	7 lb OE Delco	55-62	\$19.95	
41-0RC-7B	7 lb replacement	55-62	\$12.95	
41-0RC-16	16 lb rad cap for non stock engine application	47-87	\$13.95	

Bill's Truck Shop

Phone (905) 725-3460 / (905) 725-2022 / Fax (905) 404-2302 email: bill@billstruckshop.com

Engine - Cooling System

Group 41

Used



18-0160



18-0425-B

Thermostat

18-0160	160 deg	\$14.95
18-0180	180 deg	\$14.95
18-0195	195 deg	\$14.95

Fan Blade

41-0FB-6	6 cyl	55-62	\$25.00
41-0FB-8	8 cyl	55-59	\$25.00

41-0FB-6



Fan Belt

41-03FB-1	Chev w/ 3/8 groove pulley 6 cyl-31 1/64 x 41 3/8	55-62	\$42.95
41-03FB-2	GMC w/ 3/8 groove pulley 6 cyl	39-59	\$19.95
41-03FB-3	GMC w/ 5/8 groove pulley 6 cyl	39-59	\$29.95
41-03FB-4	GMC w/ 3/4 groove pulley 6 cyl	39-59	\$19.95
41-3FB-5	Chev w/ v8 engine 55" long	55-59	\$39.95

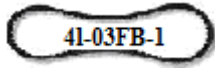

41-03FB-1

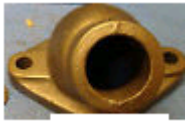

41-0453



41-0454

Thermostat Housing

41-0453	V8 engine aluminum w/ gasket front/up	\$39.95
41-0454	V8 engine/aluminum w/gasket-angle	\$24.95
18-0425-B	Base- thermostat housing 216-235 6 cyl	40-62 \$69.95

18-00HA-2



Hose Adaptors

18-00HA-1	Hose adaptors -adjusts from 1 3/4 to 2"	\$11.95
18-00HA-2	Hose adaptors -adjusts from 1 1/2 to 1 3/4"	\$11.95

41-0034



41-0058



41-0034-L



41-0058	5/8 hose fitting 1 1/2' long	\$11.95
41-0034	3/4 hose fitting 1 1/2' long	\$11.95
41-0034-L	3/4 hose fitting 2 1/2' long	\$11.95

Bill's Truck Shop

Phone (905) 725-3460 / (905) 725-2022 / Fax (905) 404-2302 email: bill@billstruckshop.com

Engine - Radiator

Group 41

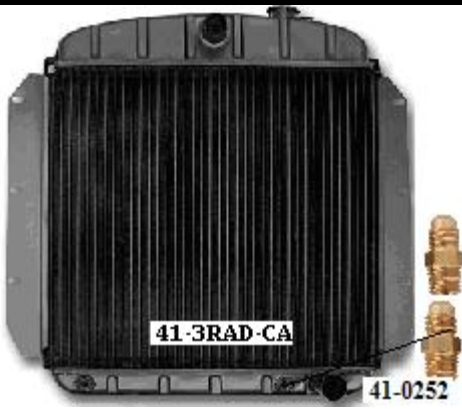

Radiator- OE style replacement modern tube-fin type cores w/side support brackets-1 1/2 top & 1 3/4 lower outlet dia. **COPPER-BRASS**

Year New Used

Please use correct lb rad cap

W/O TRANS COOLER 3 row cooling

Rad

41-3RAD-C 6 & 8 cyl w-std trans Chev
w 19 7/8 x 21 3/8 x 2 core

55-59 Inquire

41-3RAD-G 6 & 8 cyl w/ std trans GMC
w 19 7/8 x 21 3/8 x 2 core

55-59 Inquire

41-3RAD-G1 6 & 8 cyl w/ std trans GMC
w 19 7/8 x 23 x 2 core

55-59 inquire

With AUT TRANS COOLER w/ 3 row cooling tubes

41-3RAD-CA 6 & 8 cyl w-aut trans Chev
w 19 7/8 H x 23 3/8 W x 3 core-**requires fittings**

55-59 \$689.95

41-0252 when installing auto trans **copper-brass**

41-3RAD-GA 6 & 8 cyl w-aut trans GMC

55-59 Inquire

Trans Cooler Auto Fittings-required w/ aut lines

41-0252 12 x 1/2 x 1/4 NPT 9/16 drive pair

\$9.95

NEW ALUMIMUM - not polished

. These radiators are high efficiency cores with 1" cores. Core size is 19 1/4" x 22 3/4". X 2" thick Inlet is 1 1/2". Outlet is 1 3/4". These are welded construction there is no epoxy used in these radiators.--**Transmission Cooler Included** (1/2"-20 Straight Thread, inverted flare

41-3RAD-CA-B 3 row w/ auto cooler,14 lb rad cap V8 application

55-59 \$424.95

41-3RAD-CA-LS ALUMINUM - w/ LS engine update radiators are high efficiency 3 row cores for maximum cooling. w/steam blow outlet all on pass side--

55.59 \$449.95

41-3RAD-CA-2B 2 row w auto cooler 14 lb cap 6 cyl----- Core--19.38" tall x 21.75" wide x 1.75" thick--

Inlet is 1 1/2". Outlet is 1 3/4".--allows clearance for the 235 fan-rad 6 cyl application -- **please confirm engine & trans mounts are in good condition-fan sits close to rad**

55-59 \$349.95

Fan Shroud

41-3FS-1 aluminum shroud accepts 1 single 16"electric fan 19 1/3 H x 21 3/4 W

55-59 \$149.95

41-3FS universal/plastic-side mount

55-59 \$114.95

Fan Shroud-OE style w/ manual fan

41-3FS-55 Chev w/ v8

55-57 Inquire

41-3FS-58 Chev w/ v 8

58-59 Inquire

Hose-rad overflow drain 30" 3/8 thin walled-ribbed hose

10-00FH \$9.95

Radiator Petcock

41-0254 1/2 pipe brass 40-87 \$8.95

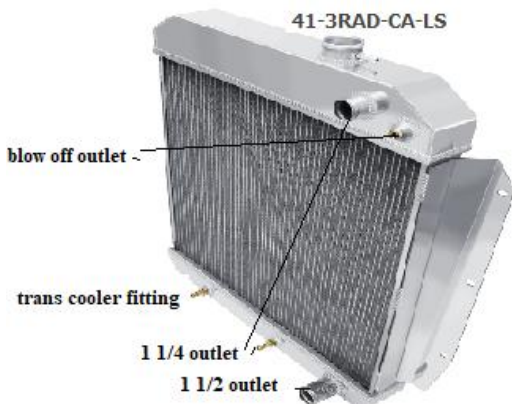

Bill's Truck Shop

Phone (905) 725-3460 / (905) 725-2022 / Fax (905) 404-2302 email: bill@billstruckshop.com



Electric Fan

44-0016 Produces a TRUE 2300 CFM Rating at 18.4 or 14 amp draw.

- This fan is 3 1/4" deep through the center of the motor; it gradually thins to 1 1/2" at the outer edge
- Curved blades are quiet and push the same amount of air as a straight blade.
- Factory built as a puller, mounted inside and pulls the air through the radiator.
- 12V REVERSIBLE 'S' BLADE - Blades & polarity of the wiring can be reversed & it becomes a pusher

universal \$99.95

44-0014 13.82 " wide//2 58 " deep 1750 CFM
12 V 90 W reversible

universal \$99.95

44-0012 12 " wide 870 CFM 12 V reversible

universal \$89.95

Relay-electric fan control

44-0016-R This adjustable electric fan switch with thermostat allows you to run your electric fan in a much more efficient manner

universal \$42.95

44-0016-S

This Electric Fan Relay with Thermostat kit allows you to run your electric cooling fan in a much more efficient manner.

It powers up your electric fan when your motor reaches - 175-185 degrees F and powers down when your motor reaches 170 degrees F w/ temp sender 50-60 amp relay

universal \$74.95

44-0016-SD

Dual fan relay Kit, 80 Amps, 12V, temp sender, two 40 Amp relays, On at 195 degrees, Off 180 degrees, Harness, Kit

universal \$114.95

Transmission Cooler

41-00TC-15 15 " dual pass external -aluminum

\$89.95

Bill's Truck Shop

Phone (905) 725-3460 / (905) 725-2022 / Fax (905) 404-2302 email: bill@billstruckshop.com

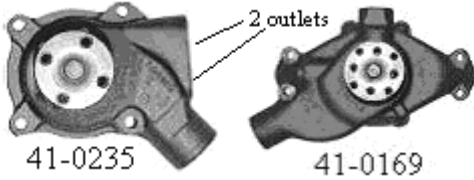

Water Pump \$15.00 core charge w/out old pump
NEW or noted as rebuilt

41-0235	Chev	w/ dual outlet-includes 1 plug-NEW	55-62	\$169.95
41-0235-1R	Chev	-rebuilt 6 cyl OE style w/ single outlet	55-62	Inquire
41-0235-2R	GMC	w/3/8 groove pulley 6 cyl rebuilt	39-59	Inquire
41-0167	GMC	w/ 5/8 groove pulley 6 cyl	39-59	\$219.00
41-0167-R	GMC	w/ 5/8 groove pulley 6 cyl rebuilt	39-59	Inquire
41-0168	GMC	w/ 7/8 groove pulley 6 cyl	39-59	\$99.00
41-0169	Chev	v/8 w/ 5 5/8 length shaft 8 cyl	55-72	\$65.00

Water Pump Pulley

41-0380	235 6 cyl	55-62	\$10.00
---------	-----------	-------	---------

Bill's Truck Shop

Phone (905) 725-3460 / (905) 725-2022 / Fax (905) 404-2302 email: bill@billstruckshop.com

Engine – Ignition

Group 41



41-02SP-49



41-02PW-6

41-03PW-8



36-0704



36-0703

36-0705



36-0083



41-0168-12



41-0774



41-3PC

41-0PC



41-0D-235



41-0HE1

Spark Plugs

41-02SP-49 6 cyl 49-62 \$5.95

Spark Plug Wire Set w/ sealed plug caps

41-02PW-6 6 cyl 7 mm 47-62 \$42.95

41-03PW-8 small block V-8 w/ point ignition 55-72 \$59.95

Spark Plug Wire Retainers-V8

36-0704 rear w/ small block 4 wire- L & R each 58-69 \$8.95

36-0795 secures on oil pan/2 wire-L & R side each 58-72 \$7.95

36-0703 secures @ heat shield on block 2 wire each 58-72 \$3.95

Spark Plug Shields

36-0083 V8 set of 4 57-72 \$34.95

Electronic Ignition-Solid state electronic system fits entirely inside distributor. Easy to install. 12 volt 216, 235 and 261 cubic inch engines

41-0168-12 54-62 \$225.00

Distributor

41-0D-235 235 CI engine/ plus \$30-00 core charge if core is not useable includes new cap, rotor, points, condenser

53-62 Inquire

Ignition Points w/Condenser

41-03PC 6 cyl 47-62 \$49.95

41-3PC V8 55-56 \$21.95

41-0PC V8 57-74 \$19.95

HEI Distributor-6 cyl

41-0HE1 47-62

Grommet-Dist wire v8 only

41-0774 57-74 \$3.50

Bill's Truck Shop

Phone (905) 725-3460 / (905) 725-2022 / Fax (905) 404-2302 email: bill@billstruckshop.com

Engine – Ignition

Group 41



41-02DC-53

41-03DC



41-03DR-57



41-2IC-6



18-0203



41-02DR-53

41-3DC-55



41-03DR-55



Dist Cap

41-02DC-53	6 cyl dist cap	53-62	\$45.95
41-3DC-55	V8 w/ side clips retainers	55-56	\$34.95
41-03DC	V8 w/ side screws	57-74	\$39.95

Dist Rotor

41-02DR-53	6 cyl dist rotor	53-62	\$19.95
41-03DR-55	V8	55-56	\$7.95
41-03DR-57	V8	57-74	\$11.95

Ignition Coil

41-2IC-6	6 volt		\$49.95
41-02IC-12	12 volt		\$39.95

Ignition Resistor

18-0203	reduces 12v to 9v		\$16.95
---------	-------------------	--	---------

Bill's Truck Shop

Phone (905) 725-3460 / (905) 725-2022 / Fax (905) 404-2302 email: bill@billstruckshop.com

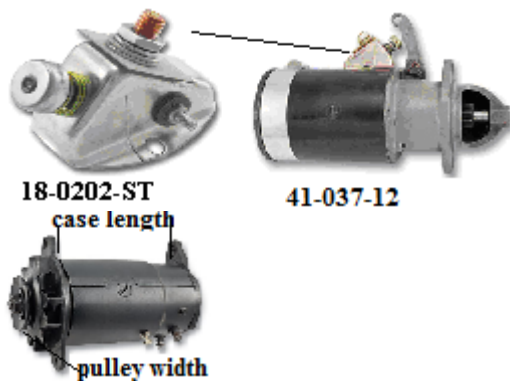

CORE CHARGE apply to starter & gen \$25.00

Starter-----REBUILT

41-037-6	6 cyl , 6 volt w/ ft start	starter	55-59	\$349.95
41-037-12	6- cyl 12 volt w/ ft start		55-59	\$349.95
41-037-12S	6 cyl 12 volt w/ key start		55-62	\$349.95
41-025-12S	V8 w/ key start solenoid—inquire w/ end housing style of application		57-62	\$349.95
41-027-12/6	6 cyl 12V starter converted to 6V for 55-62 235 engine		55-62	\$349.95



Starter Solenoid

41-0300	w/ ignition terminal w/ key start	55-75	\$59.95
---------	-----------------------------------	-------	---------

Starter Brush set

41-0059		41-62	\$14.95
---------	--	-------	---------



Roof Light

17-0033	metal housing w/ plastic amber lens 12 V bulb and mounting hdw included	each	\$39.95
17-0033-K	above lights w/ harness,switch & 5 lights (3" wide-8 ¾ long)		\$179.95

Bill's Truck Shop

Phone (905) 725-3460 / (905) 725-2022 / Fax (905) 404-2302 email: bill@billstruckshop.com



CORE CHARGE apply to starter & gen \$25.00
**Generator-----confirm 3/8 OR 5/8 pulley and 6
 “ or 7 “ case**

41-0G-6V	6 volt	REBUILT	47-63	\$295.00
41-0G-12V	12 volt	REBUILT	47-63	\$295.00

Voltage Regulator-replacement ----neg ground

18-210-6	6v w/ screw on terminals	40-55	\$122.95
18-0210-12-25	12 volt w/ 25 amp gen	47-62	\$69.95
18-0210-12-35	12 volt w/ 35 amp gen	47-62	\$69.95
18-0210-HK	OE style set of 3	47-62	\$1.20

Generator Tag---not numbered

41-000T	w 12 volt gen / includes rivets	55-62	\$8.95
---------	---------------------------------	-------	--------

Alternator-1 wire activates on RPM-NO voltage regulator required

19-0055	12 volt- 55 amp-	\$159.95
19-0033	female integral alt plug w/ terminals	\$7.95

Alternator Brackets -lower 6cyl 235 cyl engine

41-3AB	converts gen to alt -may require reshaping adjustment brace	55-62	\$89.95
--------	---	-------	---------

Generator Bracket-adjust

41-0240	283 & 327	55-62	\$44.95
---------	-----------	-------	---------

Alt Belt

41-0405	3/8 x 41 1/8	\$19.95
---------	--------------	---------

Bill's Truck Shop

Phone (905) 725-3460 / (905) 725-2022 / Fax (905) 404-2302 email: bill@billstruckshop.com



42-355M

Shop Manual --Chev
Fully illustrated Includes data, specifications, wiring diagrams etc. to repair your truck. **Supplement** issue requires previous year manual

- 42-3SM-55
- 42-3SM-56 supplement to 1955
- 42-3SM-57
- 42-3SM-58
- 42-3SM-59 supplement to 1958

Shop Manual -- GMC

- 42-3SM-GMC

Owners Manual With GM plastic folder.

Chevrolet

- 42-355C
- 42-356C
- 42-357C
- 42-358C
- 42-359C

GMC

inquire about others

- 42-355G

Accessory Installation Manual Detailed illustrations of all accessories and explains how they are installed

- 42-355M
- 42-356M
- 42-357M
- 42-358M
- 42-359M

Wiring Diagram

- 42-3WD-55
- 42-3WD-56
- 42-3WD-57
- 42-3WD-58
- 42-3WD-59

Year New Used

55-55	\$36.95
55-56	\$15.75
57-57	\$36.95
58-58	\$44.95
59-59	\$19.95
55-59	\$29.95
55-55	\$22.95
56-56	\$22.95
57-57	\$22.95
58-58	\$22.95
59-59	\$22.95
55-56	\$17.95
55-55	\$14.95
55-56	\$14.95
57-57	\$14.95
58-58	\$14.95
59-59	\$14.95
55-55	\$9.95
56-56	\$9.95
57-57	\$9.95
58-58	\$9.95
59-59	\$9.95

Bill's Truck Shop

Phone (905) 725-3460 / (905) 725-2022 / Fax (905) 404-2302 email: bill@billstruckshop.com

Manuals & Brochures

Due to the fluctuation of the Canadian and American dollars call for current prices

Group 42

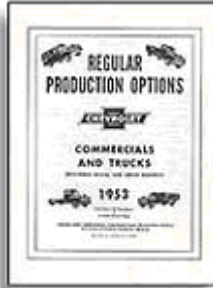
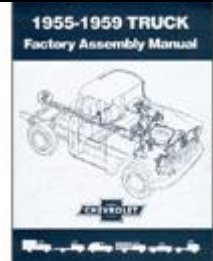

42-2RP053



42-2RP054



42-2TRG

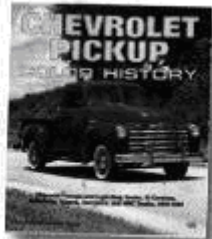

42-0CHB

Factory Assembly Manual Exploded views of the assembly of the trucks. Pertains to all years and GMC also.

42-3FAM

Year

New

Used

55-59

\$44.95

RPO Booklet Listing GM Regular Production Options for cars and trucks with prices and part codes.

42-3RP055

55-55

\$3.00

Chevrolet Pickup Colour History Book History on Chevy pickups from 1918-1984 with photos.

42-0CHB

1918-84

\$27.50

Power Steering Repair Manual

42-3PSM

55-59

\$6.00

Check our website www.billstruckshop.com for California trucks and parts

Bill's Truck Shop

Phone (905) 725-3460 / (905) 725-2022 / Fax (905) 404-2302 email: bill@billstruckshop.com

Accessories

Due to the fluctuation of the Canadian and American dollars call for current prices

Group 44

		<u>Year</u>	<u>New</u>	<u>Used</u>
	Exhaust Deflector (each)			
44-0303	44-0303		\$23.95	
	License Plate Frame - chrome w/ blue details & year on top w/ CHEVROLET on bottom			
44-2L54	each			
	NO GMC at this time			
44-028	44-3L55	55-55	\$11.95	
	44-3L56	56-56	\$11.95	
44-009	44-3L57	57-57	\$11.95	
	44-3L58	58-58	\$11.95	
44-006	44-3L59	59-59	\$11.95	
	License Plate Fasteners			
44-007	44-028 Chrome bullets set of 4		\$4.95	
	44-029 stainless steel carriage bolts w/ hdw set of 4		\$3.25	
44-0SE	44-030 4 nylon nuts w/ w screws		\$4.95	
	Headlight Half Moon			
44-0TV	44-009 Chrome 7 1/2" dia. pair		\$9.95	
	Headlight Cat-Eye Cover Chrome (pair)			
44-0255-15	44-006		\$14.95	
	Headlight Visors			
44-3151	44-007 stainless steel for 7 1/2 light pair		\$29.95	
	Street rod Emblem			
	44-0SE chrome-each		\$14.95	
	Traffic Light Viewer Repro of factory accessory.			
	44-0TV Used to assist in seeing the traffic light when truck had outside sunvisor		\$86.95	
	Door Vent Shades Original GM option			
	44-3151 stainless steel pair	47-59	\$64.95	
	Rad Overflow Tank			
	44-0255-15 15 " polished stainless steel	universal	\$84.95	
	44-0255-13 13 " polished stainless steel	universal	\$79.95	
	Truck Covers - we recommend <i>Hugger Covers</i> @ 905-857-1800 or www.huggercovers.com --also a Canadian company-great product w/ great service			

Bill's Truck Shop

Phone (905) 725-3460 / (905) 725-2022 / Fax (905) 404-2302 email: bill@billstruckshop.com



44-0PVC Accel pedal w/chrome vertical bars, rubber insert, spring loaded, adjustable arm & L or R mount universal \$89.95



44-0TBS-2 Throttle cable bkt w/ 350/400 kickdown adapt stainless steel universal \$29.95



44-0TBS Accel bkt a@carb w/ return springs stainless steel universal \$24.95



44-0TBS-1 Accel bkt bkt @ engine w/ return springs-stainless steel universal \$19.95

7-0007 Accel spring set universal \$9.95

Adjustable Throttle Cables

44-0TC-24 24" long/black coating universal \$29.95

44-0TC-24-SS 24" long/stainless steel universal \$44.95

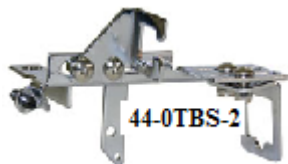

19-0412 \$129.95
Torque Converter Lockup Kit, Pressure Switch, In-line Fuse, GM, 200-4R, 700R4, Kit

Bill's Truck Shop

Phone (905) 725-3460 / (905) 725-2022 / Fax (905) 404-2302 email: bill@billstruckshop.com



Custom Designed System is Easy to install, The Hurricane unit mounts to firewall using existing original heater mounting holes and includes new plastic glove box. Heater fittings will pass neatly through the firewall under the battery tray with a custom rubber grommet.

w/ electronic control

Complete systems include: Inside Package (Hurricane Unit, Wire harness w/ deluxe control, Louvers, Duct Hose, Expansion Valve, Mounting Bracket & hardware) Compressor, Compressor Bracket, A/C Hose Kit and Condenser Assembly.

50-55-9005 55-57 Inquire

50-58-9008 58-59 Inquire

Complete, w/ Deluxe Electronic Control- Includes a new electronic deluxe lever style heater control that fits into original dash opening. The electronic Hurricane Unit features High Torque electric servo motors to operate the Bypass Heater Valve and Defrost Functions

50-55-9100 55-57 Inquire

50-58-9105 58-59 Inquire

Inside Package - Hurricane Heat Cool & Defrost Unit, Deluxe Control, Wire Harness, Heater valves, Expansion Valve, Duct Hose, Louvers, Plastic Glove Box, Mounting Brackets and Necessary Hardware.

50-55-9100-IP w/ electronic control 55-59 Inquire

50-55-9000-IP w/ manual control 55-59 Inquire

NOTES

Comp upgrade for Chrome or Polished finish Compressor Bracket, (varies by engine application- water pump

Application info 1955-57 and 1958-59 Chev or GMC

Vents	in dash	w/ 2 1/2 inlet		
50-0125-R	louvered-round-chrome	each		\$19.95
50-0125-RT	louvered-rectangle-chrome	each		\$15.95

Ducts	“ Y “ 2 1/2			
50-0225-R	round w/ 2 1/2 outlets	each		\$13.95

Hose	plastic 2 1/2			
50-0325	6 ft			\$15.95

AC TOOL

We will lend the correct tool for crimping all the ac line fitting N/C

50-0125-R



50-0125-RT



50-0225-R



50-0325



Bill's Truck Shop

Phone (905) 725-3460 / (905) 725-2022 / Fax (905) 404-2302 email: bill@billstruckshop.com



40-0175BCS



45-3559-DL



15-0301

41-0PSK-235



45-0PSCV

Column Saver kit allows reusing the original column w/ Mustang II front ends or any other replacement steering box—installs housing w/ bearing in original column—complete w/ instructions

40-0175BCS	47-59 GM trucks & cars w/ 1 ¾ column	47-66	\$144.95
40-0150BCS	GM trucks & cars w/ 1 ½ column	48-64	\$89.95

Power Steering Custom Drag Link

45-3559-DL	custom drag link for 400 series power steering box—adjustable (helps correct steering return on turns)	55-59	\$114.95
------------	--	-------	----------

Power Steering Pump Bkt kit- fits small block Chev w/ long or short neck water pump—will require additional crank pulley

15-0301			\$94.95
---------	--	--	---------

GM power steering pump bracket kit- fit early 216 & 235 engine 1947-1962—pump not included

41-0PSK-235		50-62	\$299.95
-------------	--	-------	----------

These brackets require the use of an alternator and will not work with a factory generator. Complete bolt on assembly—requires a double pulley on power steering pump

Power Rack Control Valve w/ adapt fitting

45-0PSCV	when using early power steering pumps on mustang steering rack		\$24.95
----------	--	--	---------

Bill's Truck Shop

Phone (905) 725-3460 / (905) 725-2022 / Fax (905) 404-2302 email:

bill@billstruckshop.com

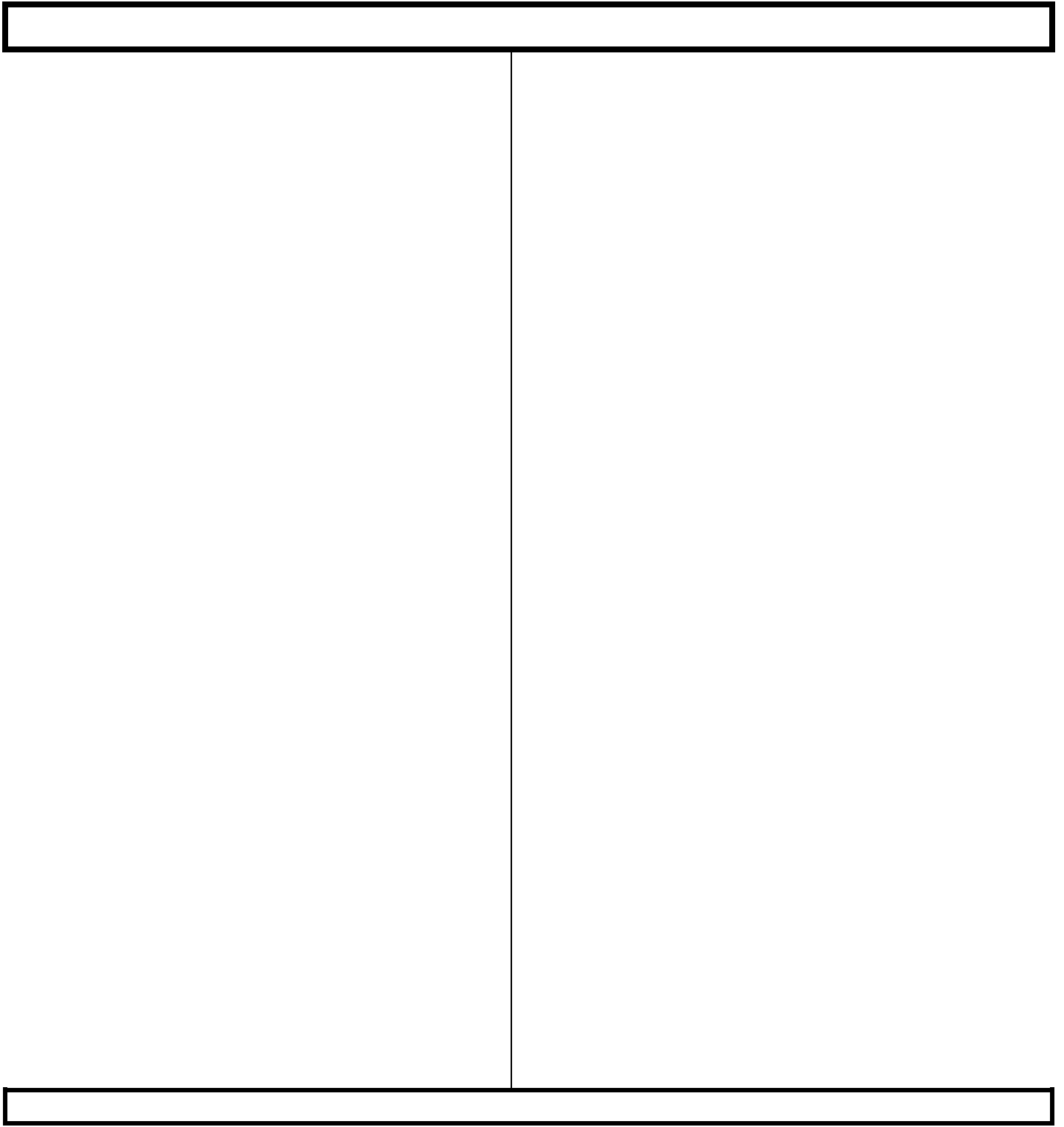

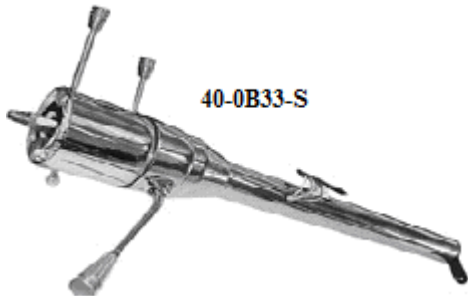
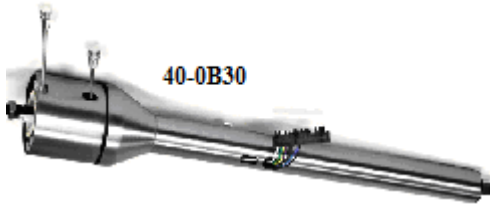

Tilt Columns-w/ new style GM signal switch w/ flat 3/8 flat plug NO P/N-rev switch

UNIVERSAL APPLICATION

Includes shift levers & indicator w/ shift-use your OE support -add support bushing # 5-0316 & lower column seal #7-308-4

40-0B33-S	Tilt Column-33"/black -aut-1" DD shaft	\$699.95
40-0B32	Tilt column-32"/black-no shift/1"DD shaft	\$699.95
40-0B32-S	Tilt Column-32"/black -aut-1" DD shaft	\$699.95
40-0B30	Tilt Column-30"/black-no shift/1"DD shaft	\$699.95
40-0B30-S	Tilt Column-30"/black -aut-1" DD shaft	\$699.95
40-0B33-S	Tilt column-33" /black w/ aut 1" DD shaft	\$699.95

IDIDIT STEERING COLUMNS US MADE

1955-59 Chevy Truck column comes with it's own specially designed under dash mount and floor mount with gasket, 1" DD output shaft .columns are available in steel (S)-chrome-(C)-brushed (BA) or polished aluminum-(PA)-black powder coated-(PB)

8 position tilt, cancelling turn signals,4 way flasher, retro style levers, neutral safety switch-3/8 flat signal harness plug, 1" DD output shaft

40-3140-TAS	tilt, aut, paintable steel	Inquire
40-3140-TS	tilt, no shift, paintable steel	Inquire

Shift Indicator-required on all columns
acrylic-stick on

3-0010-3	w/3 speed auto	\$44.95
3-0010-4	w/4 speed auto	\$44.95

40-0804	Transmission shift kit –GM 2 “ column mount/ 6’ cable w/all bkts & hdw	\$249.95
	TH350, TH400, 700-R4, TH200, 200-R4, 4L60 and 4L80E	



Steering Shaft –u-joint when joining new columns to new steering systems (eg 3/4-30 spline to double D shaft)
 CNC machined Billet Steel- **always drill a dimple in shaft where set screw seats**

41-0UJ1	9/16-26 x 3/4-DD (mustang manual rack)	\$109.95
41-0UJ3	3/4-30 x3/4-DD	\$109.95
41-0UJ4	3/4 -36 x 3/4 - 36	\$109.95
41-0UJ5	3/4-36 x 3/4-DD (mustang power rack)	\$109.95
41-0UJ6	3/4-DDx3/4-DD	\$109.95
41-0UJ7	1-DDx3/4-DD	\$109.95
41-0UJ9	13/16-36 x3/4-DD	\$109.95
41-0UJ16	3/4-DD x 3/4 smooth	\$109.95
41-0UJ17	3/4 DD x 17MM	\$109.95
41-0UJ18	3/4- 36 x 1-DD	\$109.95
41-0UJ24	3/4-30 x 1-DD	\$109.95
41-00SS	3/4 steering shaft support	\$39.95

Double Steering u-joint

41-0DUJ6	3/4DD x 3/4DD	\$204.95
41-0DUJ32	3/4-36 x 3/4 -DD	\$204.95

Steering Rag Joint

41-0RJ30	1”DD x 3/4 -30 spline	\$134.95
41-0RJ36	3/4 -36 x 11/16 -36	\$134.95
41-0RJ36-3/4DD	3/4”DD x 11/16 -36 spline	\$134.95
41-0RJ366-3/4DD	3/4 DD x 3/4-36 spline	\$134.95
41-0RJ36-1DD	1”DD x 3/4 -36 spline	\$134.95
41-0RJ366-1DD	1DD x 11/16 -36 spline	\$134.95
41-0RJ10	1”DD x 3/4” DD	\$134.95

Steering Rag Joint (mini 2 7/8 OD)

41-0RJ24-M	1”DD x 3/4 30 spline	\$114.95
41-0605S	3/4 DD x 3/4 30 spline x 3/4 round- includes drift pin-----w/ using cut OE column	\$114.95

Steering Shaft Coupler

41-0SC36	3/4 DD x 3/4 x 36	\$75.00
----------	-------------------	---------

PERFORMANCE ACCESSORIES

Group 40

40-1850-DD

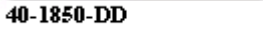

40-00SF



40-00SR



40-0626-AD

41-0UJ18

41-0UJ3

40-0CS-2x2.5



40-0LCS



40-0LCS-2

40-0LCS-4



Column Saver kit allows reusing the original column w/ Mustang II front ends or any other replacement steering box- installs housing w/ bearing in original column-complete w/ instructions

40-0175BCS	47-66 GM trucks & cars w/ 1 3/4" column	47-59*	\$72.50
40-0150BCS	47-66 GM trucks & cars w/ 1 1/2" column	47-59	\$72.50
40-0150BCS-A	47-59 GM trucks & cars w/ 1 1/2" column w/ 3/4 x 3/4 DD U-joint & stub shaft	47-59	\$134.95

40-1850-DD BLACK- steel 18"

40-1850-DDN nickel plated 18"

40-3650-DD unplated steel 36"

40-3650-DD-BO black oxide 36"

40-1870-3/4N nickel plated 3/4 round x 36 spline 24" long \$69.95

Collapsible Steering Shaft

40-0626-AD 1" DD to 3/4 DD" Adjustable steering shaft 16" to 26" nickel plated \$119.95

40-0636-AD 1" DD to 3/4 DD" Adjustable steering shaft 24" to 35" nickel plated \$129.95

Intermediate Shaft & Flange

40-00SF 9 1/4" w/ rag joint flange -accepts 3/4" shaft w/ dust boot-operates as a collapsible safety shaft \$39.95

40-00SR 4" long 3/4 round input end w/rag joint flange end-drill & pin to column shaft (recommend welding tube to shaft) \$34.95

Upper Column Support

40-0CS-2x2.5 polished aluminum 2" shaft 47-59 \$79.95

Lower Column Support w/ boot @ floor

40-0LCS-2 \$149.95

40-0LCS swivel polished aluminum w/o boot \$104.95

40-0LCS-4 adjustable swivel 2" shaft \$63.95

Bill's Truck Shop

Phone (905) 725-3460 / (905) 725-2022 / Fax (905) 404-2302 email: bill@billstruckshop.com

PERFORMANCE ACCESSORIES

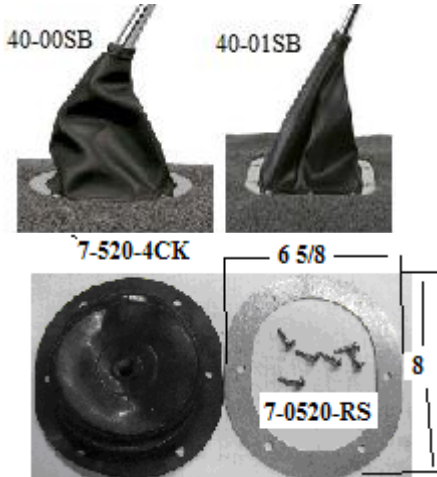

Replacement Shifter Boot w/ 4 and 5 speed std transmission

40-00SB	round shift booth w/ stainless ring 5"round	\$53.95
40-01SB	rectangular shift boot w/ stainless ring 7 long x 5 wide	NLA
7-520-4CK	4 Speed Shift Boot	\$28.95
7-0520-RSS	Retainer-20 G brushed stainless steel w hdw	\$22.95



Torque Converter Lockup Kit, Pressure Switch, In-line Fuse, GM, 200-4R, 700R4, Kit

19-0412		\$91.95
---------	--	---------



Power Steering Pulley

15-0508	Double pulley/nut on-replaces GM 3941107	\$59.95
15-0810	single groove-press on-back spaced-replaces GM 3834720	\$59.95

Alt bkt kit

50-002L-DS	drivers side mount / small block Chev w/ long neck water pump-top mount	\$136.40
50-002S-DS	drivers side mount / small block Chev w/ short neck water pump-top mount	\$136.40

Water Pump Pulley

50-0155	5.5" in w/6" outer double pulley @ water pump 2 1/4 hole spacing replaces GM # 14023155	\$129.95
50-0142	6" double pulley -w/ short neck water pump w/ 1 3/4 hole spacing replaces GM # 3995642	\$94.95
50-0142-C		

Bill's Truck Shop

Phone (905) 725-3460 / (905) 725-2022 / Fax (905) 404-2302 email: bill@billstruckshop.com

BRAKES



PRE-5564



PRE-9



PRE104-3824

36-0PCH



17-0BV-B



45-0213



Intake Vacuum Port

17-0VP-1 1 port hose fitting - 3/8" intake hole- for power brakes \$29.95

Intake Vacuum Port 2 port T fitting - 3/8" intake hole- for power brakes & 1/4" auto trans modulator line \$29.95

17-0VP-3 3 Intake Vacuum Port 3 port fitting - 3/8" intake hole- for power brakes-auto trans & AC Inquire

Brake Booster & PCV Hose

36-0PCH 3/8 x 35" w/ clamps \$24.95

Brake Booster Check Valve

17-0BV-B black \$15.95

Universal brake booster

45-0DD8 8" dual diaphragm zinc plated \$189.95

Pedal support/Pad

45-0213 \$29.95

Bill's Truck Shop

Phone (905) 725-3460 / (905) 725-2022 / Fax (905) 404-2302 email: bill@billstruckshop.com

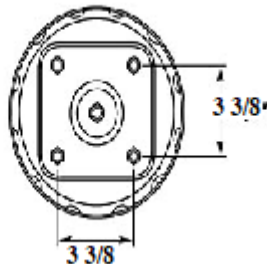
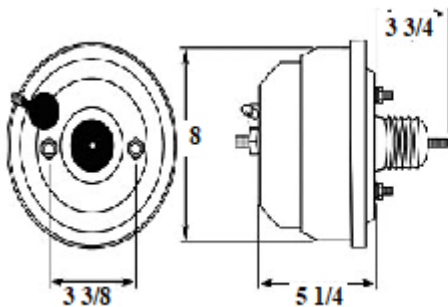

BRAKES



Proportioning Valves

17-0PVKS-2	Brake Proportioning Valve -disc/drum w/ lines-when converting to disc- ft-drum rear	BRASS	\$149.95
17-0PVKS-4	Brake Proportioning Valve -disc/drum w/ lines-when converting to disc-disc	BRASS	\$149.95
17-0PVKS-A4	Brake Proportioning Valve - disc/drum & or disc/drum w/ lines & bracket	ALUMINUM	\$159.95

Harness-proportioning valve switch

17-0PVK-H	replacement harness w/ socket	\$19.95
-----------	-------------------------------	---------

Disc Brake kit

45-0WBK-5	47-59-5 lug disc brake kit —uses stock ½ spindles & hubs Kit includes rotors, callipers, brackets, flex hoses and hardware Bearing upgrade(tapered roller w/ seals) may not work with stock wheels	47-59	\$659.95
-----------	---	-------	----------

45-0WBK-6	47-59-6 lug disc brake kit —uses stock ½ spindles & hubs/ kit -includes rotors, callipers, brackets, flex hoses and hardware-Bearing upgrade(tapered roller w/ seals) is recommended-calipers may not work with stock wheels	47-59	\$799.95
-----------	---	-------	----------

38-04759-BK	Wheel Bearings kit -upgrades to tapered roller bearings w/ grease seals ½ ton only	47-59	\$199.95
-------------	---	-------	----------

38-04759-S	Grease seal -replacement for bearing kit	each 47-59	\$13.95
------------	---	------------	---------

45-0DBK-5	47-59 Disc brake upgrade bkt kit	47-59	\$174.95
-----------	---	-------	----------

5 x 4 ¾ bolt pattern-add callipers, 11", rotors w/ bearing upgrade kit, brackets, flex hoses and hardware-bolts to stock spindles. Converts your straight axle to disc brakes-used factory holes on ½ ton spindle-kit includes calliper brackets, bearing adaptors & hdw-used 70-77 Camaro rotors & callipers- -will also have to upgrade to dual master & prop valve

17-0BR13	Inner wheel bearing	each	\$16.95
17-0BR2	Outer wheel bearing	each	\$14.95
17-0984	grease seal	each	\$5.95

Bill's Truck Shop

Phone (905) 725-3460 / (905) 725-2022 / Fax (905) 404-2302 email:

bill@billstruckshop.com

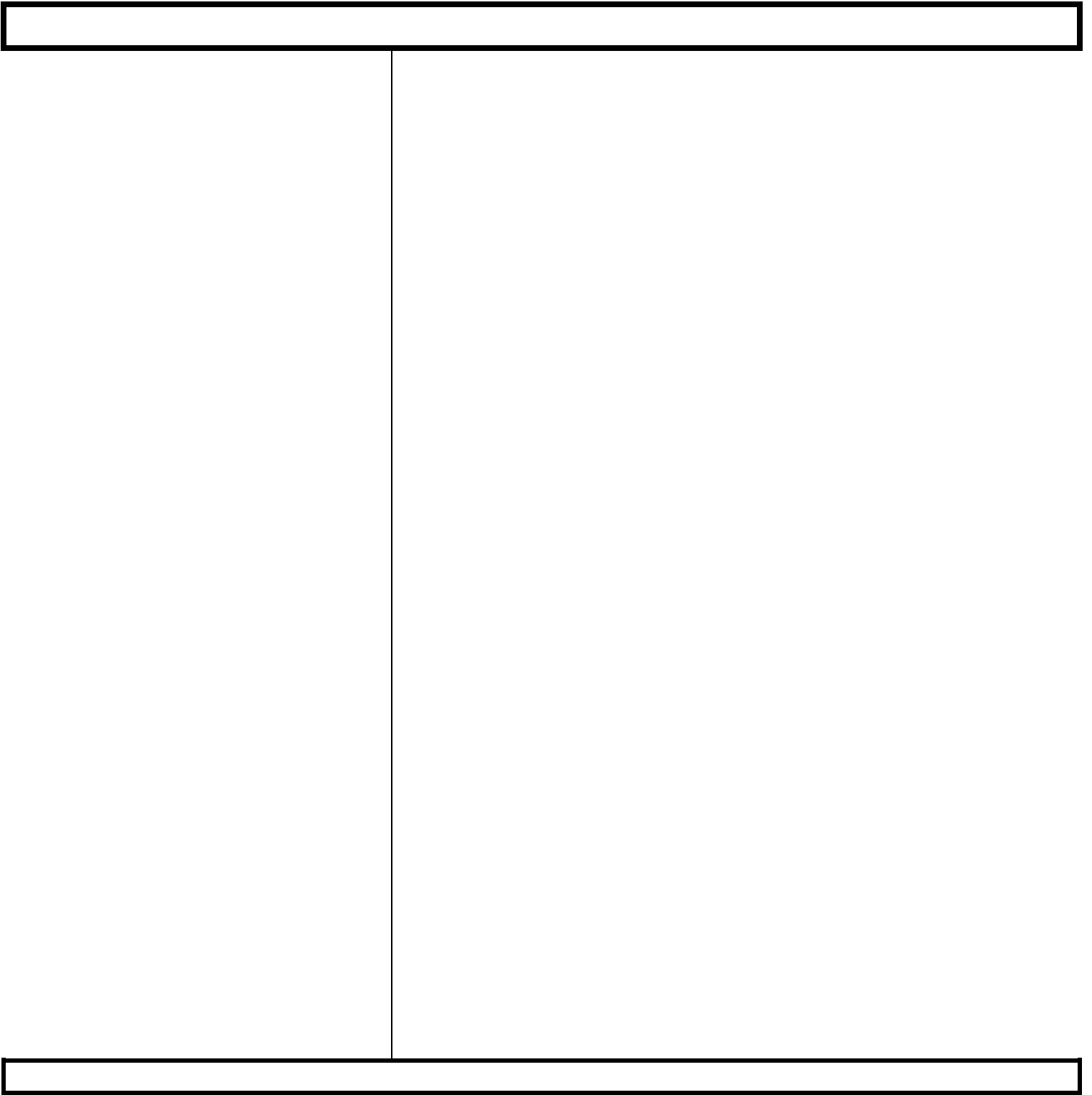



55-59 **Mona leaf springs**-exceeds multi leaf specifications $\frac{3}{4}$ " thick-
improves handling and ride w/ lower ride height-fit original shackles-
include bushing and u-bolts- gives 3' drop front and 4" drop rear

45-3CTFR	front/pair 3"	\$535.00
45-3CTRS	rear/pair 4"	\$535.00



55-59 Firewall mount brake booster kit-bolts to firewall(remove original column support) includes mount bracket, pedal w/ linkage, 8 "booster, master cylinder 1" bore, & prop valve -Add # 45-0134 mechanical brake light switch

45-3559-FB4-8 disc-disc & disc drum \$649.95

45-3559-FB bracket w/ pedal only \$245.00

55-59 Frame **mount brake booster**-bolts in the stock location using original pedals-includes 8" dual diaphragm booster, 1 " bore master cylinder, proportioning valve, mount bracket w/ hardware & prop valve - brake lines will need modifying

45-3BBD-8D drum-drum application -no prop valve \$589.95

45-3BBD-8DD disc-disc & disc drum application \$624.95



45-3BBD-SDD

45-3BB-7-P disc- drum w/ prop valve, 1" master, 7" dual diaphragm & pedal assembly w/ hdw \$495.95



45-3BB-7-P



55-59 Rear say bar kit (w/ stock suspension)-helps reduce roll and increase steering stability-complete w/ 7/ 8 bar, poly bushing, brackets and hardware will mount on stock and flip applications w/ rear axle tube to 3" dia

40-3RSB \$299.95

45-3559-FSK



55-59- Front sway bar-(w/ stock suspension) original style-helps improve driveability by reducing roll and lane darting-kit complete w/ hardware and instructions 1" bar-w/ original I-Beam



55-59- Front sway bar-(w/ stock suspension) helps improve driveability by reducing roll and lane darting-kit complete w/ hardware and instructions 1" bar-performance upgrade w/ V8 engine @ original I-Beam

45-3559-FSK-P \$279.95



Power steering pitman arm when converting to power steering box

45-0759PA-PS standard height \$79.75

45-0759PA-PR reversed for lowered trucks \$74.75

HARDWARE

49-0610	5 /16-18 x 7/8 w/11/16 floating washer-NC	each	\$1.65
49-0612	5/16-18 x 1 w /7/8 floating washer-NC	each	\$2.10
49-0613	5/16 -18 x 3/4 w/ washer head -NC	each	\$1.65
49-0614	3/8-16 x 1 w/ 1 floating washer-NC	each	\$2.95
49-0615	3/8 -16 x1 1/2 w/ 1 1/8 floating washer NC	each	\$3.25
49-0710	5/16 – 18 U – nut	each	\$1.50
49-0620	5/16 -18 x 3/4 w/ OE style washer head NC	each	\$0.95
49-0621	5/16 -18 x1 1/16 dog point w/ floating washer-each		\$1.75
49-0622	5/16 -18 x 15/16 dog point w/ floating washer-each		\$1.95

BODY ALIGNMENT SHIM-galvanized steel

20-000D	1/16 w/ 3/8 slot shim	each	\$1.25
20-000E	1/8 w/ 3/8 slot shim	each	\$1.25
20-000K	8 pc Shim kit 4 x 1/16 and 4 x 1/8	set of 8	\$9.95

Totally Stainless bolt kits

Every Body Kit includes component kits-for Front Bumper, Door Hinges, Door Latch & Catch, Fender to Firewall Brace Rods, Front & Inner Fenders, Grill & Gravel Pan, Headlight & Parking Lens, Hood Hinges, Hood Latch, Catch & Braces, Interior, Outside Mirror, Radiator Support, and Regulator & Relay.

49-3324	55-55 Chev -Body Bolt kit- 18-8 stainless steel w/ indented hex bolts-OE style /cab forward does not include bed any bed hdw		\$369.95
49-3238	56-57 Chev -Body Bolt kit- 18-8 stainless steel w/ indented hex & Philips head bolts & -OE style /cab forward does not include bed any bed hdw		\$369.95
49-3294	58-59 Chev -Body Bolt kit- 18-8 stainless steel w/ indented hex bolts-OE style /cab forward does not include bed any bed hdw		\$369.95



Bill's Truck Shop

Phone (905) 725-3460 / Fax (905) 725-2022 / email: bill@billtruckshop.com

Chevrolet Chassis Identification

Years	Series & Model	Class	Wheelbase	Bed Type
1955 2nd Series	3100 3104	1/2 Ton	114"	Stepside
	3124	1/2 Ton	114"	Fleetside
	3200 3204	1/2 Ton	123-1/4"	Stepside
	3600 3604	3/4 Ton	123-1/4"	Stepside
1956-1957	3100 3104	1/2 Ton	114"	Stepside
	3124	1/2 Ton	114"	Fleetside
	3200 3204	1/2 Ton	123-1/4"	Stepside
	3600 3604	3/4 Ton	123-1/4"	Stepside
1958	3100 3104	1/2 Ton	114"	Stepside
	3124	1/2 Ton	114"	Fleetside
	3134	1/2 Ton	114"	Fleetside
	3154	1/2 Ton	114"	Stepside
	3200 3204	1/2 Ton	123-1/4"	Stepside
	3234	1/2 Ton	123-1/4"	Fleetside
	3600 3604	3/4 Ton	123-1/4"	Stepside
	3634	3/4 Ton	123-1/4"	Fleetside
	3654	3/4 Ton	123-1/4"	Stepside
	3684	3/4 Ton	123-1/4"	Fleetside
1959	3100 3104	1/2 Ton	114"	Stepside
	3134	1/2 Ton	114"	Fleetside
	3154	1/2 Ton	114"	Stepside
	3200 3204	1/2 Ton	123-1/4"	Stepside
	3234	1/2 Ton	123-1/4"	Fleetside
	3600 3604	3/4 Ton	123-1/4"	Stepside
	3634	3/4 Ton	123-1/4"	Fleetside
	3654	3/4 Ton	123-1/4"	Stepside
	3684	3/4 Ton	123-1/4"	Fleetside

1955-59 Chevrolet Serial Identification Number

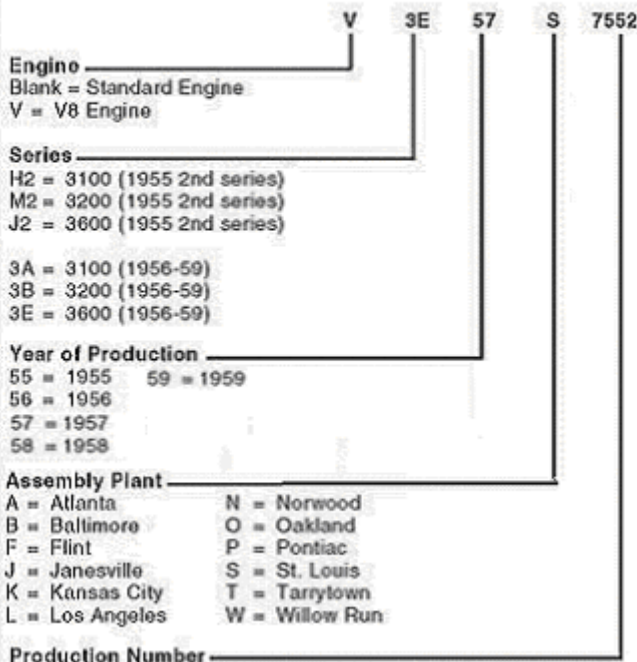

1955-59 2nd Series GMC Serial Identification Number

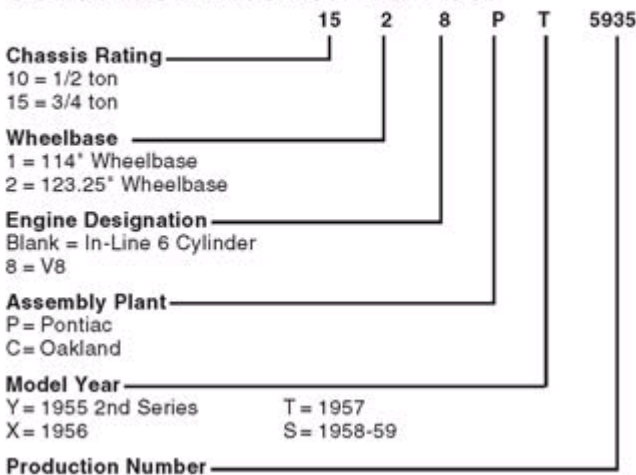

GMC Chassis Identification

Years	Series & Model	Class	Wheelbase	Bed Type
1955-56 2nd Series	100 1766	1/2 Ton	114"	Stepside
	100 1768	1/2 Ton	114"	Suburban Pickup
	100 150 1767	1/2 & 3/4 Ton	123-1/4"	Stepside
1957	100 1766	1/2 Ton	114"	Stepside
	100 1768	1/2 Ton	114"	Suburban Pickup
	100 150 1767	1/2 & 3/4 Ton	123-1/4"	Stepside
	100 150 1799	1/2 & 3/4 Ton	123-1/4"	Stepside
1958	100 1766	1/2 Ton	114"	Stepside
	100 1768	1/2 Ton	114"	Suburban Pickup
	100 1802	1/2 Ton	114"	Fleetside
	100 150 1799	1/2 & 3/4 Ton	123-1/4"	Stepside
	100 150 1804	1/2 & 3/4 Ton	123-1/4"	Fleetside
1959	100 1766	1/2 Ton	114"	Stepside
	100 1802	1/2 Ton	114"	Fleetside
	100 150 1799	1/2 & 3/4 Ton	123-1/4"	Stepside
	100 150 1804	1/2 & 3/4 Ton	123-1/4"	Fleetside

Chevrolet Engine Identification

1947-59 3100, 3200, 3600

Years	Series & Model	Class	Wheelbase	Cylinder	Bed Type
1955 2nd Series	3100 3200 3600		235	6 Cylinder	I-6
	3600		265	8 Cylinder	V-8
1956-1957	3100 3200 3600		235	6 Cylinder	I-6
	3100 3200 3600		265	8 Cylinder	V-8
1958-59	3100 3200 3600		235	6 Cylinder	I-6
	3100 3200 3600		283	8 Cylinder	V-8

When you build a chassis and position the driveline components, you need to orient them so that the angle of a line drawn through the center of the transmission exiting through the output shaft (A) and a line drawn through the center of the driveshaft (B) is equal to but opposite the angle of a line drawn through the pinion shaft in the rear differential (C) and the line drawn through the center of the driveshaft (B). The accompanying drawing illustrates how the lines drawn through the transmission and pinion shafts (A&C) are parallel to each other, though not in the same plane.

Next step is to measure the rear end pinion shaft angle. It should be pointing upward towards the front with the vehicle sitting at ride height on a level surface. At least 1-degree and ideally not more than 3-degrees up. You can alter the rear end pinion shaft angle by inserting or removing wedge shaped shims under the rear spring mounts or by adjusting the length of the control arms positioning the rear end.

