

NOV 2024

Bills Truck Shop Limited

CHEV GMC

1960-1966

BUY TRADE

SELL

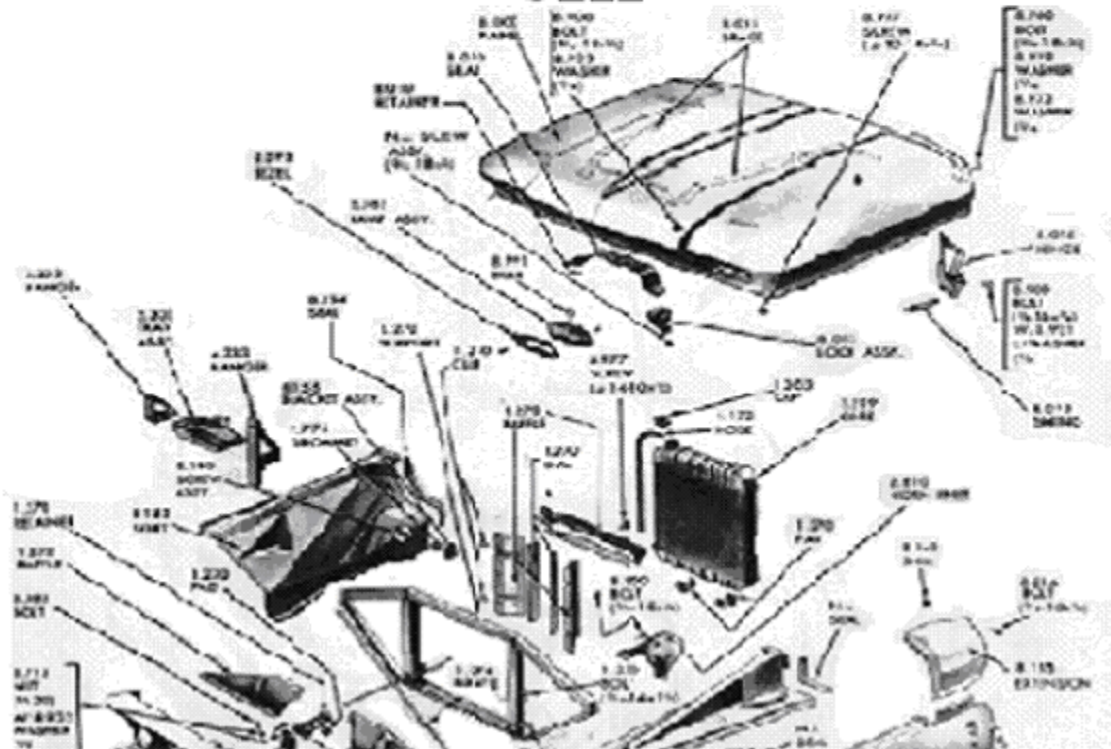

PHONE: (905) 725-3460
(905) 725-2022

FAX (905) 404-2302

Web: www.billstruckshop.com
Email: bill@billstruckshop.com
rob@billstruckshop.com
aaron@billstruckshop.com

GENERAL INFORMATION

Ordering Information: Please make sure you are ordering the correct parts. Verify part numbers upon ordering. On larger orders please fax (905)404-2302 or email at bill@billstruckshop.com or rob@billstruckshop.com or call for more information.

Payment: We accept VISA, MasterCard, Money Orders, Personal and Company cheques. Payment plans also available on large restoration. Applicable taxes apply to all purchases.

Shipping: Ship by your choice of Canpar, UPS, FedEx, and Postal or truck carrier (\$10.00 crating charge apply to truck freight orders) Most orders can be shipped same day for next business day delivery. Actual shipping charges will be applied. Also a \$10.00 surcharge applies to C O D orders.

Pricing: Prices are in Canadian currency. constant fluctuation between the Canadian and U.S. dollar –refer to the prices in the catalogues as a **GUIDE ONLY!** Bill's Truck Shop Limited Ltd., reserves the right to make appropriate changes as necessary. We try to keep prices low by keeping a large inventory on hand at all times .WE never buy parts with YOUR money to sell to YOU so we never precharge you for normal stocking items that are out of stock
Returns and Guarantees: If fault is found in the parts or workmanship of item purchased, full money back guarantee or exchange for new item. If fault occurs from installation or misuse, no return will be given. No refunds will be given on electrical components or literature. Call with any questions.

Back Orders: No shipping charges will be applied to regular stocked items, unless a manufacturer's back order applies. All back orders cancelled after 60 days.

Discounts: Business's may apply for discounts after providing valid tax exemption numbers.

Regular customer discounts will be applied depending on volume purchases/ monthly specials and payment type. (E.g.: 3% discount on cash sales on applicable items) Check our website for monthly specials.

Parts: ever increasing supply of reproduction parts, they are not always listed in the catalogues. New items can be viewed on our website, www.billstruckshop.com or call for info.

Used Parts: Unlike many other parts suppliers we stock or locate many parts that are not reproduced. We travel to the southern states (California) and bring back trucks, beds, cabs etc. Bill's Truck Shop Limited has made a commitment to supply many new and used parts for your restoration and as a result we are the largest truck part supplier in Canada. NO discounts to used parts!

We also will take your used parts in on trade

Hours of Operation: Monday to Friday 8 o'clock AM to 5 o'clock PM EST
Sunday and holidays –closed & Saturdays by appointment only

NOTE: IF DRIVING LONG DISTANCE TO VIEW OUR INVENTORY, PLEASE CALL AHEAD!

WEB: www.billstruckshop.com

Bumpers & Brackets

Group 1

Part No.			<u>New</u>	<u>Used</u>
BUMPERS & BRACKETS				
Bumpers –Premium Quality – triple nickel plated, and then chrome to a mirror finish - Lesser Quality (B) chromed				
FRONT				
1-400-C	60-62	chrome		\$399.95
1-400-P	60-62	paint		\$299.95
1-403-C	63-66	chrome	also will fit panel & Suburban rear- center bolt does not line up	\$399.95
	63-66	chrome	also will fit panel & Suburban rear- center bolt does not line up - bumpers w/ shipping damage etc	Inquire
1-403-P	63-66	paint		\$299.95
REAR				
1-410-C	60-62	Fleetside	chrome	\$399.95
1-410-P	60-62	Fleetside	paint	\$274.95
1-413-C	63-66	Fleetside	chrome	\$349.95
1-413-P	63-66	Fleetside	paint	\$299.95
1-412-C	60-66	Stepside	chrome	\$424.95
1-412-P	60-66	Stepside	paint	\$274.95
1-415	60-66	Rear Step Bumper	stepside or fleetside	Inquire
1-0515	63-87	Rear Step Bumper	diamond top-chrome-light duty towing-for fleetside trucks –mount brackets extra	Inquire
1-0515-B	63-87	Rear Step Bumper bkt set	for #1-0515	Inquire
1-0022	47-87	Bolt- bracket to frame w/ hdw-	½ x 1 ½ each	\$1.50
FRONT BRACKETS w / hardware				
1-420-L	60-66	Front Bumper Bkt -outer	left	\$43.95
1-420-R	60-66	Front Bumper Bkt -outer	right	\$43.95
REAR BRACKETS w / hardware				
1-430-F	60-62	Fleetside	set of 4	\$159.95
1-433-F	63-66	Fleetside	set of 4	\$129.95
1-430-S	60-62	Stepside	set of 4	\$189.95
1-433-S	63-66	Stepside	set of 4	\$169.95
GRAVEL Guards/ hardware - located between bumper & bed				
1-435-F	60-66	Fleetside	-sit on bumper bkts pair	\$59.95
1-435-S	60-66	Stepside	- sit on bumper bkts pair	\$52.95

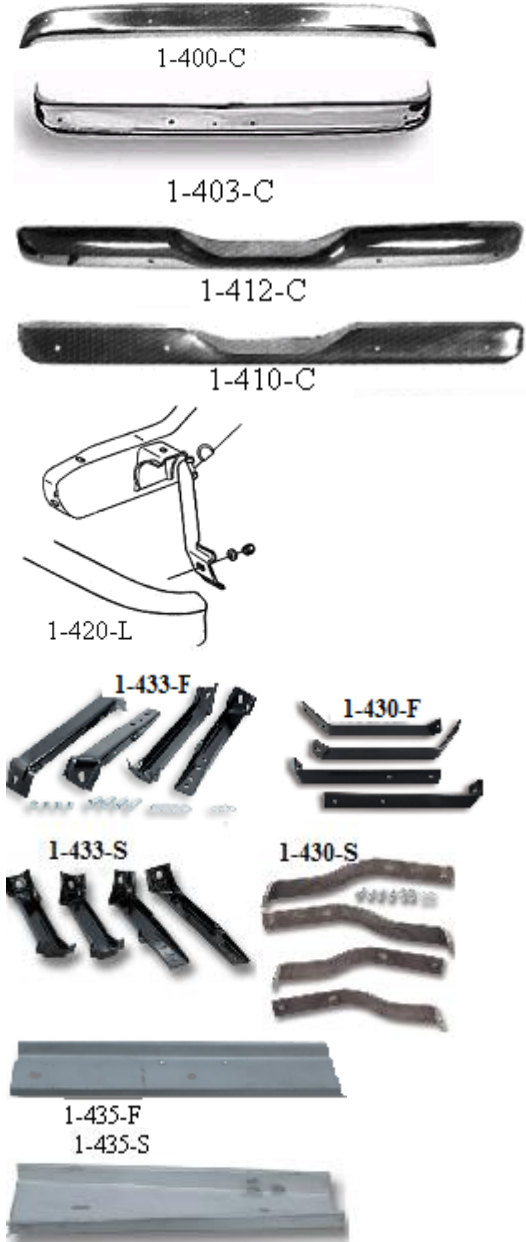

Bill's Truck Shop Limited

Phone (905) 725-3460 / (905) 725-2022 / Fax (905) 404-2302 email: bill@billstruckshop.com

Bumpers & Brackets

Group 1

Part No. New Used

LICENSE PLATE BRACKET w/hardware

18-0303-F	58-66 Rear Plate Bkt w / light-fleet & stepside-mount to bumper	\$62.95
18-0812	58-66 Plate Bkt bolts- stainless capped bolt @ bumper pair	\$9.95
18-0303-L	58-66 Plate Light Lens-glass	\$9.95
18-0303-G	58-66 Plate Light Lens- gasket	\$1.50
44-030	47-87 License Plate Mount Kit 4 screws & 4 nylon nuts	\$4.95

LICENSE PLATE LIGHT

18-0303-U	59-87 All with out bumper-fleetside/ under rear cross sill	\$19.65
1-0545-2	60-87 All with step bumper-screw on style	\$14.95
1-0545-3	60-87 All with step bumper-inserts in 1 7/16 round hole	\$6.95

BUMPER BOLTS w/ hdw

Check all bumper bolts for dept of square collar-may require grinding down to prevent washer bottoming out-diff years have diff thickness

1-0BBC	47-87 Bumper bolt chrome w/ hdw	each	\$5.95
1-0BBS	47-87 Bumper bolt w/ hdw stainless steel cap -flat top	each	\$5.95
1-0BBP	47-87 Bumper bolt black w/ hdw	each	\$6.50

BUMPER GUARDS

1-450-C	60-62 Bumper Guards front - chrome w/hardware	disc
1-453-C	63-66 Bumper Guards Front -chrome w/hardware	disc

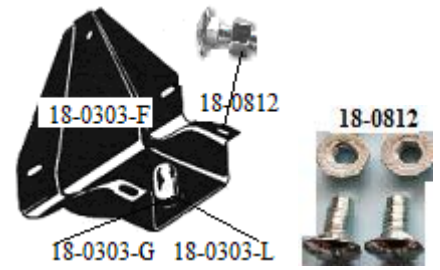

1-0545-2



44-030



1-0545-3



1-0BBS



1-0BBC

Bill's Truck Shop Limited

Phone (905) 725-3460 / (905) 725-2022 / Fax (905) 404-2302 email: bill@billstruckshop.com

Grilles & Bezels

Group 2

<u>Part No.</u>			<u>New</u>	<u>Used</u>
CHEV GRILLE				
2-400-CP	60-60 Chev Grille	painting		Inquire
2-400-CC	60-60 Chev Grille	chrome		Inquire
2-401-CP	61-61 Chev Grille	painting		Inquire
2-401-CA	61-61 Chev Grille	aluminum		Inquire
2-402-CP	62-62 Chev Grille	painting		Inquire
2-402-CC	62-62 Chev Grille	chrome		Inquire
2-403-CP	63-63 Chev Grille	painting		Inquire
2-403-CC	63-63 Chev Grille	chrome		Inquire
GRILLES DO NOT INCLUDE END SUPPORTS				
2-404-CP	64-66 Chev Grille	black w/ stamped letters	\$524.95	
2-404-CC	64-66 Chev Grille	chrome w/ black stamped letters	\$599.95	
2-404-CC-A	64-66 Chev Grille	chrome w/black stamped letters & lamp buckets installed NEW	\$899.95	
2-404-B	63-66 Grille Letters	black	\$5.95	
2-404-W	63-66 Grille Letters	white	\$5.95	
2-404-CA	64-66 Chev Grille OE grille with black lettering	anodized aluminum NEW	\$699.95	



1963



1964

Bill's Truck Shop Limited

Phone (905) 725-3460 / (905) 725-2022 / Fax (905) 404-2302 email: bill@billstruckshop.com

<u>Part No.</u>		<u>New</u>	<u>Used</u>
CHEV LIGHT BEZELS			
2-400-BP	60-61 Bezels-grille Chev painted		\$80.00
2-400-BC	60-61 Bezels-grille Chrome chrome		Inquire
2-400-K	60-61 Headlight bezel screw kit 8 pcs	\$3.00	
2-402-BP	62-62 Bezel- grille Chev painted w/hdw each	\$59.95	
2-402-BC	62-62 Bezel-grille Chev chrome w/hdw each	\$79.95	
2-402-K	62-62 Bezels screw set-secures to the 4 stands on housing 8 pcs	\$2.50	
2-403-BP	63-63 Bezels -grille Chev painted		Inquire
2-403-BC	63-63 Bezels -grille Chev chrome-pair	\$89.95	
2-403-K	63-63 Headlight bezel screw/clip kit 12 pcs	\$6.95	
2-404-BP	64-66 Chev Grille Bezels painted		Inquire
2-404-BC	64-66 Chev Grille Bezels chrome---pair	\$99.95	
2-404-K	64-66 Headlight bezel screw/clip kit 12 pcs	\$7.95	
	NEW		
2-404-BA	64-66 Headlight bezel Aluminum pair	\$99.95	
HEADLIGHT SUPPORTS			
	Chev -supports light assembly to grille		
2-400-LS	60-61 Headlight Support -can be used on 60-66 GMC/remove bezel stands left or right-each	\$89.95	\$75.00
2-403-LSL	63-63 Headlight Support left		\$75.00
2-403-LSR	63-63 Headlight Support right		\$75.00
2-404-LSL	64-66 Headlight Support left	\$129.95	\$75.00
2-404-LSR	64-66 Headlight Support right	\$129.95	\$75.00
2-404-HK	60-66 Support to grill hdw kit-both sides-Chev & GMC 8 screws w/ nuts	\$3.00	
2-404-SHK	60-66 Support to grille surround hdw kit-both sides-8pcs	\$11.95	
19-0422	62-68-L & R Headlight cup-Chev-each	\$37.95	\$10.00



Bill's Truck Shop Limited

Phone (905) 725-3460 / (905) 725-2022 / Fax (905) 404-2302 email: bill@billstruckshop.com

<u>Part No.</u>		<u>New</u>	<u>Used</u>
HEADLIGHT CUP			
2-0401-I	60-61 Headlight cup Chev/GMC inner / each	Inquire	
2-0401-O	60-61 Headlight cup Chev/GMC outer / each	inquire	
Headlamp Cup -GMC for head light			
The following "cups" fit 58-59 Chev / GMC and 60 -66 GMC- Note-cups are stamped w/ "1 for inside and "2 for outside w/L for left and R for right			
16-0307-1	58-66 outer / left -drivers side	\$37.95	\$20.00
16-0307-2	58-66 inner / left- drivers side	\$37.95	\$20.00
16-0307-3	58-66 outer / right - pass side	\$37.95	\$20.00
16-0307-4	58-66 inner / right - pass side	\$37.95	\$20.00
Note-cups are stamped w/"1 for inside and "2 for outside w/L for left and R for right -headlight must sit vertical			
GMC -supports light assembly to grille			
2-405-LSL	60-66 left		\$100.00
2-405-LSR	60-66 right		\$100.00
Grille			
2-405-GP	60-66 GMC Grille painted	Inquire	\$150.00
2-405-GC	60-66 GMC Grille chrome	Inquire	Inquire
NEW GMC LIGHT BEZELS			
2-405-BP	60-66 GMC Grille Bezels painted pair	\$249.95	
2-405-BC	60-66 GMC Grille Bezels chrome pair	\$299.95	
2-405-K	60-66 GMC Bezel Screw kit w/j-nuts (6)	\$3.00	

See section # 19 for park light etc

Due to the fluctuation of the Canadian and American dollars call for current prices



GMC



2-405-LSL



16-0307



2-405-K



2-405-BC

Bill's Truck Shop Limited

Phone (905) 725-3460 / (905) 725-2022 / Fax (905) 404-2302 email: bill@billstruckshop.com

Steering Columns & Parts

Group 3

<u>Part No.</u>	<u>STEERING COLUMNS & PARTS</u>	<u>New</u>	<u>Used</u>
	1960-1962,/1964-1966 Steering Columns Auto or Standard		Inquire
3-401-0	60-60 Turn Signal Lever	\$19.95	
3-401-1	61-62 Turn Signal Lever	\$22.95	
3-401-3	63-66 Turn Signal Lever	\$22.95	
3-402	60-66 Lever Auto or 3 Speed -chrome	\$39.95	
3-0402-P	60-70 Shift Lever Retainer Pin	\$2.25	
3-402-HS	60-66 Spring-shift handle –aut or std /under handle in column	\$4.25	
3-402-B	60-66 Shift Lever Boot @ housing std & auto	\$6.95	
3-402-S	60-66 Shift Lever Shim- in housing-aut & std	\$6.95	
3-402-K	61-66 Shift Handle Knob--black plastic 3 speed or auto will also fit 60 but not correct appearance	\$12.95	
3-0440-G	55-66 Shift Lever Grommet w/ metal lining each	\$6.75	
3-410-H	62-66 Auto Trans indicator Housing--chrome	\$14.95	
3-410-L	62-66 Auto Trans indicator Lens - 2-speed	\$9.50	
3-0541-G	60-76 Shift rod grommet on column w/ auto 1/2 ID	\$3.25	
3-0541-B	60-78 Shift rod bushing w/ auto 3/8" ID, 1/2" OD.	\$3.50	
3-0542-G	60-76 Grommet-3 speed std @ trans lever pair	\$13.95	
5-0211-F	40-72 Floor Shift Knob –black w/o shift pattern	\$16.95	
3-425-L	60-66 Lower Column Seal - sponge	\$7.95	
3-425-LR	63-66 Lower Column Seal Retainer		\$15.00
3-0TSL-L	47-72 Auto Shift Linkage-column to trans/stain-steel/ to 23" long V8 aut application	\$114.95	

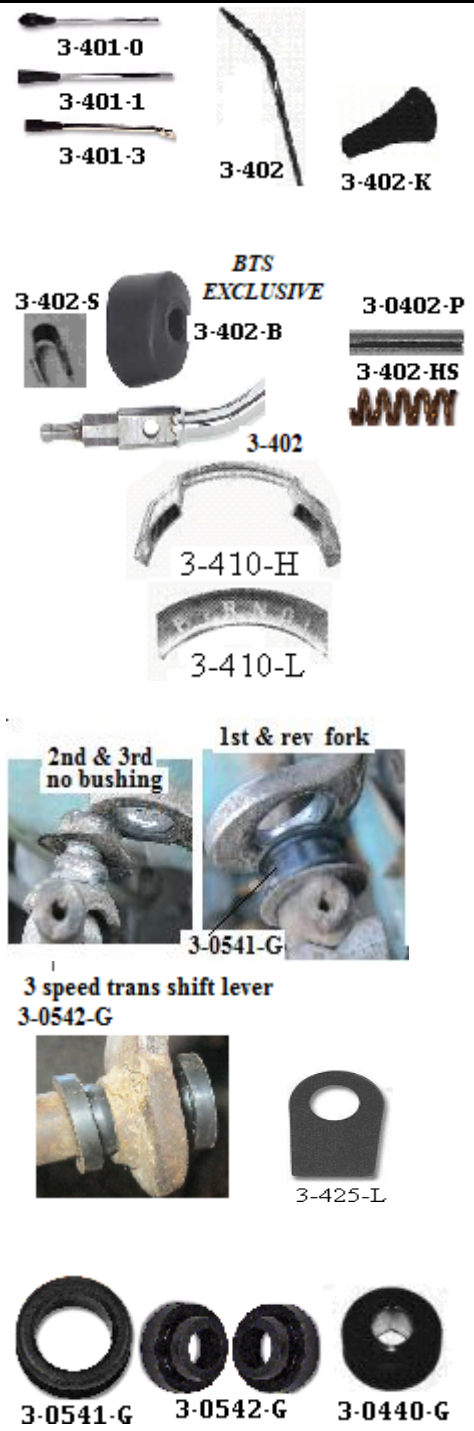

Bill's Truck Shop Limited
 Phone (905) 725-3460 / (905) 725-2022 / Fax (905) 404-2302 email: bill@billstruckshop.com

Steering Columns & Parts

Group 3

SIGNAL SWITCHES

Used

Please test all signal switches before installing in column-can be connected externally--NO WARRANTY on switches w/ out factory steering wheel-please note center steering shaft location when removing steering wheel & switch-must not be under load from cab sag etc -call for more information

3-403-0	60-62 Signal Switch Chev & GMC cable activated	\$42.95	
3-403-0K	60-60 Turn Signal Mechanism repair kit-includes springs, retainers & bushings	\$44.95	
3-403-1K	61-62 Turn Signal Mechanism repair kit-includes springs, retainers & bushings	\$49.95	
3-403-0B	60-62 Turn Signal Mechanism hold down Bolt	\$3.50	
3-403-60	60-61 Cable-turn signal switch 24" long	\$24.95	
3-403-62	62-62 Cable-turn signal switch 19 1/4" long	\$24.95	
3-403-3	63-63 Turn Signal Switch w/ out bearing -double 1/2 moon harness connector CHEV & 64-66 GMC See 3-46063-UB for bearing w/ horn wire-signal lever hole is "round" & closer to bottom of housing	\$99.95	
3-46063-UB	60-63 Chev & some 64-66 GMC (w/ GMC style signal switch) w/ Upper Column Bearing w/ horn wire	\$69.95	
3-403-3C	63-63 Turn Signal	\$6.50	
3-403-4	64-66 Turn Signal Switch w/ upper bearing & horn contact ring-----Chev only-signal lever hole in housing is "D" shaped and @ near top of housing	\$89.95	
3-403-4C	64-66 Turn Signal Cancel Cam	\$5.95	
3-403-GMC	64-66 Signal Switch for GMC/see 3-403-3	Inquire	Inquire
3-403-C	61-66 Turn Signal Canceller-on steering wheel	\$11.95	
3-403-60C	60-61 Turn Signal Canceller-on steering wheel	\$10.00	
18-0214-HK	54-66 Signal cancel cam hdw kit	\$1.25	
3-4600-61	1961-62 GM accessory 4-way flasher kit	Inquire	
3-4600-63	1963-63 GM accessory 4-way flasher kit	Inquire	
3-4600-64	1964-64 GM accessory 4-way flasher kit	Inquire	
3-4600-65	1965-66 GM accessory 4-way flasher kit	Inquire	



Bill's Truck Shop Limited

Phone (905) 725-3460 / (905) 725-2022 / Fax (905) 404-2302 email: bill@billstruckshop.com

Steering Columns & Parts

Group 3

		<u>Used</u>	
18-0213-F12-L2	12 volt 2 pin-use w/ LED lights Signal Flasher	\$22.50	
14-0SF-12	4-Way or Signal Flasher	\$9.95	
14-0SF-12HD	4 Way or Signal Flasher-HD electronic	\$10.95	
3-0417	60-72 Neutral Safety Switch w/ auto (male tab w/ slot) 60-72 Rev Light Switch w/ 3 speed standard on column-please confirm that the column bearings are in good condition-NO warranty on broken switch stud-includes screws	\$16.95	\$5.00
3-0MRS		\$32.95	
3-0417-S	60-72 Neutral safety & rev light switch screw set	\$1.99	
3-412-LC	60-66 Column support-lower	\$57.95	

<u>3-0TSL-L</u>	47-72 Auto Shift Linkage-column to trans/stain-steel/ to 23" long V8 aut application	\$94.95
-----------------	--	---------

40-0804	Transmission shift kit –GM 2 “ column mount/ 6’ cable w/all bkts & hdw--- TH350, TH400, 700-R4, TH200, 200-R4, 4L60 and 4L80E	\$259.95
---------	--	----------



Bill's Truck Shop Limited

Phone (905) 725-3460 / (905) 725-2022 / Fax (905) 404-2302 email: bill@billstruckshop.com

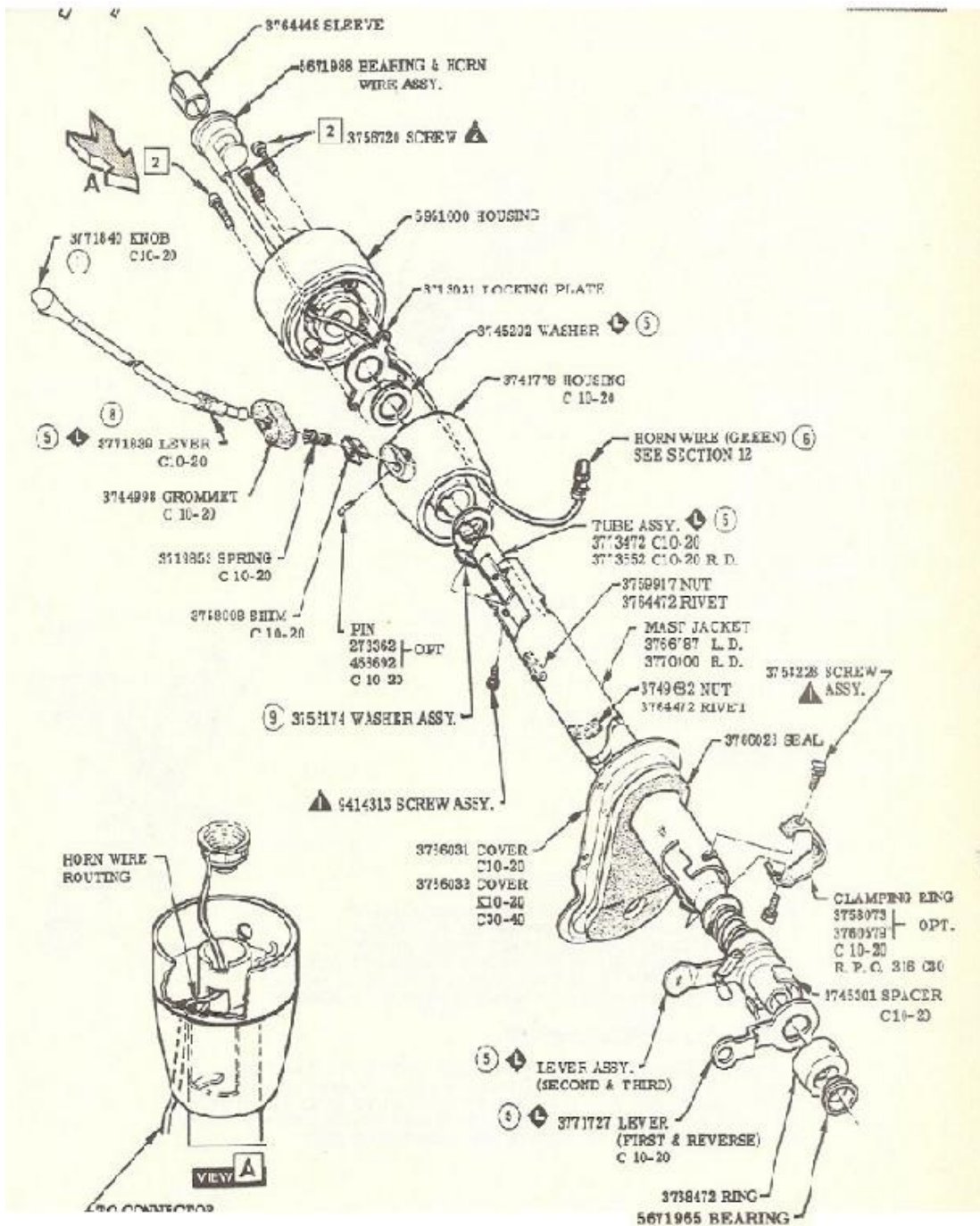

disconnect the shifter arms

-----loosen the 2 bolts--see picture

-----move the 2 levers in line w/ shift selector

-----MUST be neutral position

-----NOW tap the bolts counter clockwise-you will see the collar move up to remove the SLACK between the arm and selector

-----tighten the 2 bolts

-----install the arms-making sure they are in neutral at trans

----- confirm that the shift lever pivots are not worn or loose where they install in the arms

--always lube (i use auto transmission oil) at shift lever into the column shift tube

--they were assembled w/ grease and the gets hard and contaminated w/ dirt

--ALWAYS try to follow the "H" shift pattern

and happy trucking

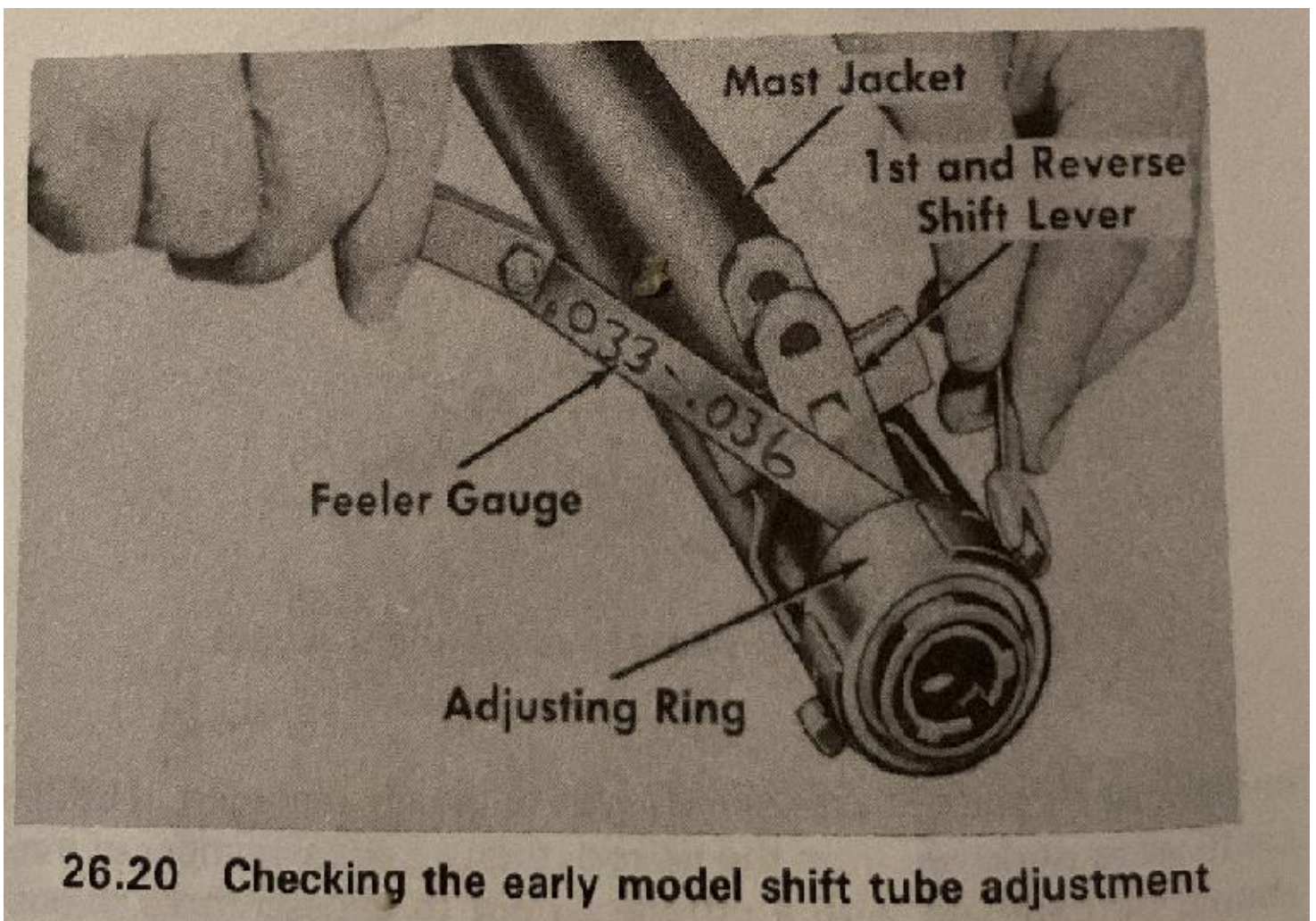

Steering Columns & Parts

Group 3

Part No.		New	Used
BEARINGS			
3-06068-LB	60-68 Lower Column Bearing	\$39.95	
3-46063-UB	60-63 Upper Column Bearing w/ horn wire	\$26.95	\$10.00
3-06472-UB	64-72 Upper Column Bearing non tilt	\$19.95	
3-06068-S	60-68 Spring -lower column @ lower bearing		\$10.00
3-06972- LB	69-72 Lower Column Bearing kit w/o tilt	\$33.95	

HORN PARTS & WHEELS			
3-420-C	60-66 Chev horn cap chrome w/ red bowtie-std wheel w/ rubber retainer #3-0420-R	\$84.95	\$20.00
3-420-G	60-66 GMC horn cap chrome	\$55.00	\$20.00
3-0420-R	60-68 Horn cap retainer -rubber	\$15.95	\$5.00

3-0520-60I	60-68 Horn cap retainer-insulator w/ std wheel approx. 5/16 tall post---white	\$10.95
3-0520-68I	62-80 Horn cap retainer-insulator approx. 3/8 tall post---red w/ dlx wheel	\$10.95

5-0201-4	47-66 Horn contact pin & bushing	\$12.95
3-0520-60R	60-68 Horn cap retainer cup & hardware-1" high steel retainer	\$16.95
5-0230-N	47-72 Steering wheel Retaining Nut	\$1.95

3-0421-K	60-66 Horn & horn cap retainer kit w/ dlx wheel w/ red insulator	\$29.95
3-0421-SK	60-68 Horn & horn cap retainer kit w/ std wheel w/ white insulator includes horn contact for 60-066 & 67-68	\$49.95
3-425-D	60-66 Steering Wheel deluxe	Inquire
3-421	60-66 Deluxe Chev Horn Ring	Inquire

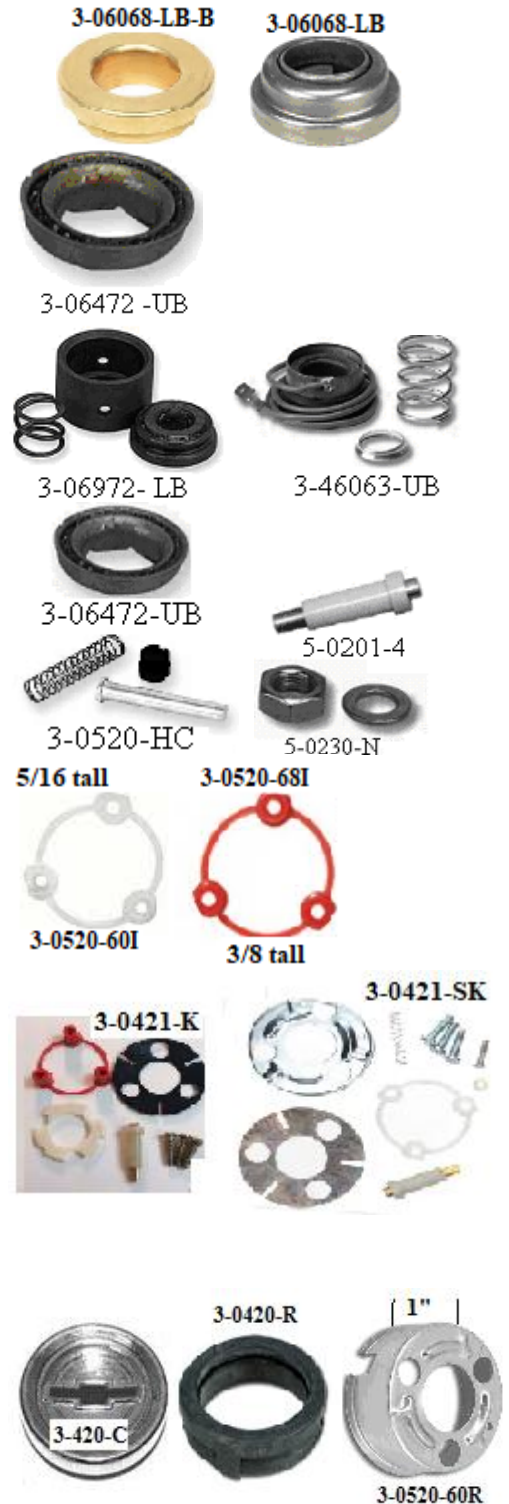

Bill's Truck Shop Limited

Phone (905) 725-3460 / (905) 725-2022 / Fax (905) 404-2302 email: bill@billstruckshop.com

Tilt columns -include all levers

Columns are direct fit into OE location on 60-66 trucks 3/4 x 36 output shaft spline -will not accept OE steering wheel

US columns made by IDIDIT-shift column include P-N switch

3-4066-T	60-66 Tilt column w/o shifter- black	Inquire
3-4066-ST	60-66 Tilt column w/ shifter- black	Inquire
3-4066-ST-C	60-66 Tilt column-chrome w/ shift	Inquire

Universal Tilt Column

30 " 1967-72 GM truck style w/1"DD output shaft-GM flat harness connector

40-0030-TA	Tilt-auto shift-black 30" w/ 1" DD output shaft	
40-0030-T	Tilt-floor shift-black 30" w/ 1" DD output shaft	\$699.95
3-0010-4	Auto Shift Indicator w/ 4 speed auto-acrylic-stick on	\$44.95
3-0010-3	Auto Shift Indicator w/ 3 speed auto -acrylic-stick on	\$44.95

STEERING COLUMN ADAPTOR

19-4616	60-62 Adapts 69-74 flat style steering column signal harness to the 60-62 dash harness	\$56.95
19-4618	63-66 Adapts 69-74 flat style steering column signal harness to the 63-66 dash harness	\$59.95
3-0010	Female signal adaptor plug w/ ends- to adapt to the flat signal switch plug used on replacement columns	\$17.95

3-425-S	61-66 Steering Wheel Standard black	\$359.90
---------	-------------------------------------	----------

REPLACEMENT STEERING WHEELS

5-5625	67-72 Steering Wheel-comfort grip-black includes mounting hub-Chev horn cap-horn contact plate and mounting screws Classic styled brushed stainless steel 3-spoke steering wheel with black cushioned grip. Includes chrome horn button with Chevrolet Bowtie. 15 inches diameter with 4 1/2" dish.	\$339.95
5-5625-P	Horn Contact Plate w/ comfort steering wheel	\$35.50
5-5625-H	Hub-steering wheel mounting	\$54.95
5-5625-C	Cap-horn cap-Chev black/red/white details	\$45.95
5-5625-G	Cap-horn cap-GMC black/red/white details	Inquire

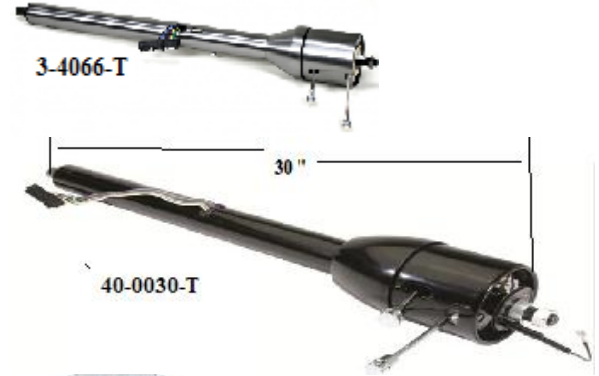

Bill's Truck Shop Limited

Phone (905) 725-3460 / (905) 725-2022 / Fax (905) 404-2302 email: bill@billstruckshop.com

Column Steering Shaft extension 3/4 DD shaft
when extending from column to steering rack or box

40-1850-DD	unplated steel 18"	\$34.95
40-1850-DDN	nickel plated 18"	\$46.95
40-3650-DD	unplated steel 36"	\$49.95
40-3650-DD-BO	black oxide 36"	\$44.95
40-3650-DD-SS	stainless steel 36"	\$119.95

Collapsible Steering Shaft

40-0626-AD	Adjustable steering shaft 16" to 26"	\$119.95
40-0636-AD	Adjustable steering shaft 24" to 35"	\$129.95

Intermediate Shaft & Flange

9 1/4 long--- 3/4 DD input end-becomes a slip shaft when installing 3/4 DD shaft w/ rag joint flange & dust boot -accepts 3/4 shaft add nec rag joint to box --- **operates as a collapsible safety shaft**

40-00SF	4" long 3/4 round input end w/rag joint flange end-drill & pin to column shaft (recommend welding tube to shaft)	\$39.95
---------	--	---------

40-00SR		\$34.95
---------	--	---------

Steering Shaft -u-joint when joining new columns to new steering systems (eg 3/4-30 spline to double D shaft) CNC machined Billet Steel

41-0UJ3	3/4-30 x 3/4-DD	\$109.95
41-0UJ4	3/4 - 30 x 3/4-36	\$109.95
41-0UJ5	3/4-36 x 3/4-DD	\$109.95
41-0UJ6	3/4-DD x 3/4-DD	\$109.95
41-0UJ7	1-DD x 3/4-DD	\$109.95
41-0UJ9	13/16-36 x 3/4-DD	\$109.95
41-0UJ16	3/4-DD x 3/4 smooth	\$109.95
41-0UJ18	3/4 36 x 1"DD	\$109.95
41-0UJ24	34/30 x 1DD	\$109.95
41-0UJ26	1DD x 1DD	\$109.95
41-0SC36	3/4 DD x 3/4 x 36 shaft COUPLER	\$75.00
41-00SS	Support-steering shaft 3/4 dia	\$39.95
41-0DUJ6	3/4DD x 3/4DD double u-joint	\$204.95
41-0DUJ32	3/4-36 x 3/4 -DD double u-joint	\$204.95

Steering Rag Joint

41-0RJ30	1"DD x 3/4 -30 spline	\$134.95
41-0RJ36	3/4 -36 x 11/16 -36	\$134.95
41-0RJ36 -3/4DD	3/4"DD x 11/16 -36 spline	\$134.95
41-0RJ36 -1DD	1"DD x 3/4 -36 spline	\$134.95
41-0RJ366 -1DD	1DD x 11/16 -36 spline	\$134.95
41-0RJ36-1DD	1"DD x 3/4 -36 spline	\$134.95
41-0RJ10	1"DD x 3/4" DD	\$134.95

Steering Rag Joint (mini 2 7/8 OD)

41-0RJ24-M	1"DD x 3/4 30 spline	\$114.95
41-0605S	3/4" DD x 3/4 30 spline x 3/4 round-includes drift pin-----w/ using cut OE column	\$114.95



41-0UJ7



41-0SC36

41-0DUJ32



41-00SS



41-0RJ30



Switches-Relays-Horn

Group 3

Part No.		New	Used
14-042-H	47-87 High Tone 12 V horn –replacement type	\$21.95	
14-042-L	47-87 Low Tone 12V horn- replacement type	\$21.95	
14-0452-HOE	63-87 Horn-low tone-OE style	\$99.95	
14-0452-HOE	63-87 Horn-high tone-OE style	\$99.95	
18-0309-57	57-62 Horn relay w/ push on pins	\$21.95	
18-409	63-66 Horn Relay-locates @ rad support	\$46.95	

14-0452-LOE



14-042-H



IGNITION

3-430-0S	60-61 Ignition Switch w/ adapter harness-- in dash panel	\$82.95	
3-430-2S	62-66 Ignition Switch-in instrument panel	\$38.95	
18-013	47-66 Ignition Cylinder & Keys (old style key) (double hole removal)	\$21.95	
18-013-B	47-66 Ignition Cylinder & Keys –extension allows for vehicle to be started w/o keys if not placed in lock position & can only be locked w/ keys w/ 2 keys (double hole)	\$25.95	
3-430-60B	60-63 Chev & 60-66 GMC Ignition Bezel –in recessed hole of dash panel	\$10.00	
3-430-B	64-66 Ignition Bezel –Chev-in instrument panel	\$10.95	\$6.00



18-0309-57



18-409



3-430-0S

18-013-K	Key-blank GM key 47-66 BLANK ignition-door-glovebox each	\$8.95	
----------	--	--------	--



3-430-B



3-430-60B

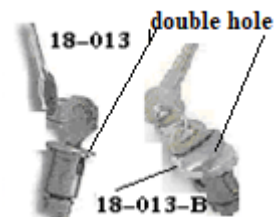

18-013

double hole

18-013-B

18-013-K



Due to the fluctuation of the Canadian and American dollars call for current prices

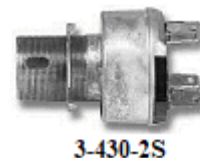

3-430-2S



pin location

Bill's Truck Shop Limited

Phone (905) 725-3460 / (905) 725-2022 / Fax (905) 404-2302 email: bill@billstruckshop.com

Switches-Relays-Horn

Group 3

<u>Part No.</u>		<u>New</u>	<u>Used</u>
3-4HS	60-63 Headlight Switch	\$44.85	
3-0HS	64-72 Headlight Switch	\$23.95	
3-404-0	60-63 Headlight Knob &Rod -black /stainless	\$11.25	
3-404-4	64-66 Headlight Knob &Rod -black /stainless	\$16.00	
3-401-4S	64-66 Headlight Knob &Rod -black		\$10.00
3-404-R	60-66 Headlight Switch Retainer	\$17.95	
3-0BS	62-80 Brake Light Switch w/ nuts	\$8.50	
18-308-57	57-60 Headlight Dimmer Switch-secures to removable floor plate	\$24.95	
3-405-P	60-60 Plate-dimmer switch mount w/hdw		\$15.00
3-0DS	61-82 Headlight Dimmer Switch	\$12.95	
3-0DS-P	60-82 Dimmer Switch Plug Connector w/ hdw	\$7.95	

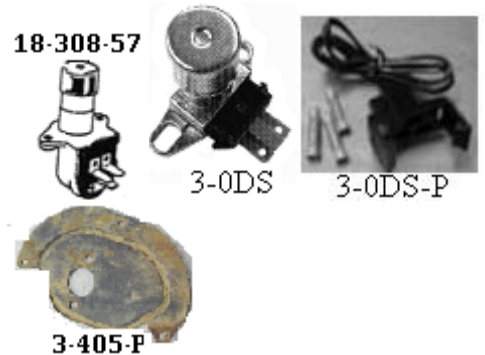
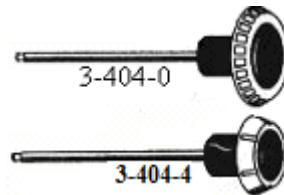











Due to the fluctuation of the Canadian and American dollars call for current prices

Bill's Truck Shop Limited

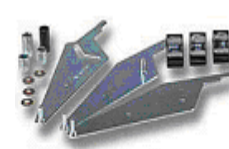
Phone (905) 725-3460 / (905) 725-2022 / Fax (905) 404-2302 email: bill@billstruckshop.com

HEATER

Group 3

<u>Part No.</u>		<u>New</u>	<u>Used</u>		
	GM used 3 diff heaters- 60-63 Recirculating heater w/ blower motor in cab & 2 lever control panel > Thrift Air w/ blower motor in engine bay & cable control and manual heat-def> 60-66 Deluxe w/ blower motor in engine bay & 4 lever control panel –cable water valve-fresh air flapper-60-63 and 3 lever control panel 64-66				
4-400-C	60-63 Heater Control		\$75.00		
4-400-LS	60-63 Heater Control Lever kit w/ dlx heater W / 4 knobs knobs		\$69.95		
4-400-DL	60-63 Heater Control Lever –deluxe heater control w /3 levers & fan switch OE die-cast –each for HEAT-AIR-DEF		\$24.95		
4-400-K	60-63 Dlx Heater Knob set (4) black also used on recirculating heater w/ 2 control levers		\$13.95		
4-400-S	60-63 Heater Fan Switch		\$69.95		
4-404	64-66 Heater Control Assembly-includes, levers, cables, switch and knobs		\$229.95		
4-404-HK	64-66 Heater control install hdw kit		\$2.50		
4-404-LS	64-66 Heater Control Lever kit w/ hdw-stamped steel		\$69.95		
4-404-AF	64-66 Heater Control Lever Air/Fan OE die-cast (center) each		\$25.95	\$15.00	
4-404-DH	64-66 Heater Lever Def or Heat-OE die cast (outer) sides on 3 lever control each		\$25.95	\$15.00	
4-0085-K	47-87 Heater Cable Retainer 3 pc		\$0.90		
4-404-K	64-66 Dlx Heater Knob set (3) black		\$12.95		
4-0401-FS	67-72/64-66 w/ dlx heater Heater Fan Switch w/ out AC		\$19.95		

Due to the fluctuation of the Canadian and American dollars call for current prices

Bill's Truck Shop Limited

Phone (905) 725-3460 / (905) 725-2022 / Fax (905) 404-2302 email: bill@billstruckshop.com

Heater & AC

Group 4

Part No.		New	Used
22-305-S	rotary OE style w/ standard heater w/ black knob- accepts OE chrome knob---2 speed / universal	\$33.95	
4-0512	60-72 Fan Speed Resistor w/o AC	\$29.95	\$5.00
4-0512-AC	64-72 Fan Speed Resistor w/ AC	\$29.95	
4-405-S	64-66 Heater Switch w / Cable for standard heater see page 17 for pin style connect info	\$99.95	\$25.00
4-405-B	64-66 Heater Switch Bezel		\$5.00
4-405-R	64-66 Heater Switch Retainer		Inquire
4-405-K	64-66 Heater Switch Knob-dlx w/'D" shaft liner--- fits "D" shaft	\$13.95	
4-4848	64-66 Heater Control Plate w/retainer (Chev) w/standard heater	\$39.95	
4-404-AC	64-66 AC Cable Bezel set (3)	\$84.95	
4-404-CG	64-66 Heater Cable Grommet w/ AC in dash housing 3pc set	\$14.95	
4-400-CE	60-63 Heater Cable w/ Economy Heater 1 pc	\$12.50	
4-400-CD	60-63 Heater Cable Set w/ Deluxe Heater 3 pc	\$54.95	
4-404-CA	64-66 Heater Cable Set w/ AC 3 pc	\$59.95	
4-404-CD	64-66 Heater Cable Set w/ Deluxe Heater 3 pc	\$54.95	
4-0085-K	47-87 Heater Cable Retainer 3 pc	\$0.75	
22-0203-HM12	60-63 Heater Fan Motor 5/16 shaft w/std under dash heater & 64-66 w/ std under dash heater	\$109.95	
4-0411-64-F	64-77 Heater Motor (light duty) w/ plastic blower fan w/o AC	\$149.95	
4-0411-64	64-77 Heater Motor HD-----w/ vent tube hole	\$79.95	
4-0411-F	64-72 Heater Motor Fan- -use only w/ HD fan motor steel w/ set screw	\$51.95	
4-0409-MG	60-87 Heater Motor Gasket	\$4.20	
4-0411-SK	64-72 Heater Motor Screw kit- 6 pcs	\$2.50	

Heater Identification

Recirculating Heater 1960-63: Blower motor located in cab under dash. Has two lever control panel.

Thrift Air Heater 1964-66: Blower motor located in engine bay. Single knob control air pull fan knob.

Deluxe Heater 1960-66: Blower motor located in engine bay. 1960-63 has a four lever control panel. 1964-66 has a three lever control panel.

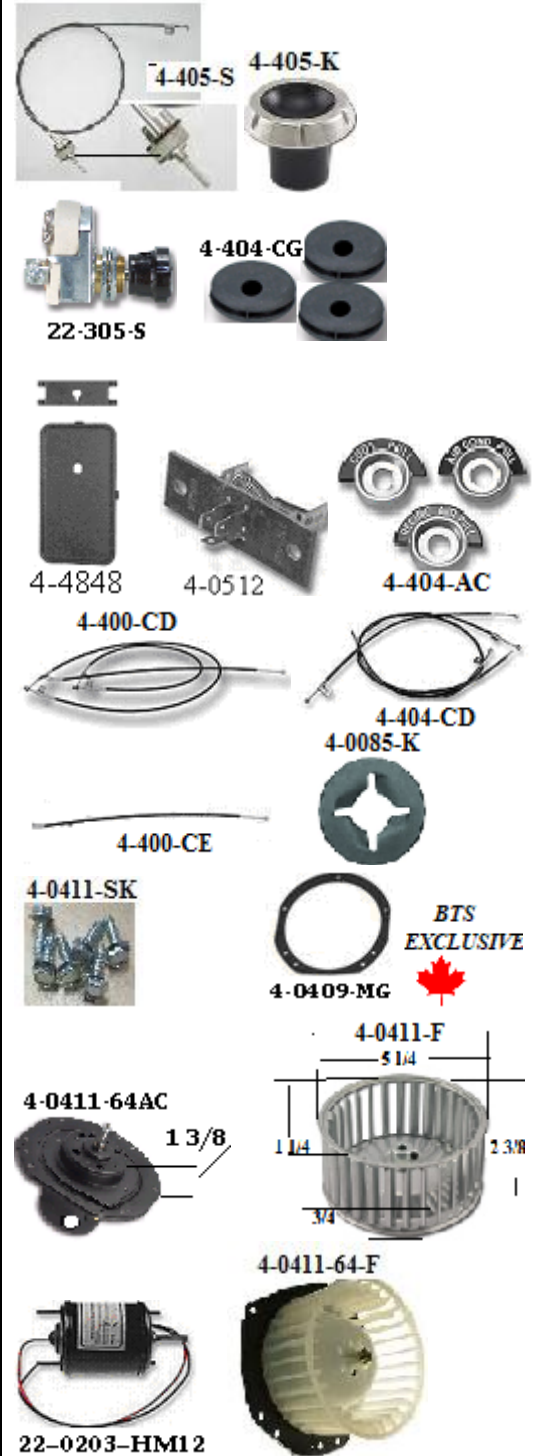

Bill's Truck Shop Limited

Phone (905) 725-3460 / (905) 725-2022 / Fax (905) 404-2302 email: bill@billstruckshop.com

Heater & AC

Group 4

<u>Part No.</u>		<u>New</u>	<u>Used</u>
	Used heater cores cleaned and tested w/ reinforced outlets		
4-400-HCS	60-63 Heater Core copper w/ -standard under dash recirculating heater 7 1/8Lx6-3/8Wx2 1/2D	\$199.95	
4-400-HCS-U	60-63 Heater Core w/ standard under dash recirculating heater 7 1/8Lx6-3/8Wx2 1/2D USED - rebuilt w/ reinforced outlets		\$75.00
4-400-HCD	60-66 Heater Core -Deluxe-9 1/2 Lx6-3/8Wx2 1/2 D- has operational fresh air flap-cable controlled-OE copper core— WHEN AVAILABLE	Inquire	
4-400-HCD-A	60-66 Heater Core -Deluxe-9 1/2 Lx6-3/8Wx2 1/2 D- has operational fresh air flap-cable controlled- ALUMINUM	\$149.95	
4-400-HCD-U	60-66 Heater Core -Deluxe-9 1/2 Lx6-3/8Wx2 1/2 D USED - rebuilt w/ reinforced outlets - has operational fresh air flap-cable controlled		\$75.00
4-404-HCS	64-66 Heater Core Standard 7 1/4 Lx6-3/8Wx2 1/2D - has no operational fresh air control flap copper/brass	NLA	
4-404-HCS-U	64-66 Heater Core Standard 7 1/4 Lx6-3/8Wx2 1/2D - has no operational fresh air control flap USED - rebuilt w/ reinforced outlets		\$75.00
4-404-HCS-A	64-66 Heater Core Standard 7 1/4 Lx6-3/8Wx2 1/2D - has no operational fresh air control flap ALUMINUM	\$138.95	
4-415	64-66 Defrost Vent Outlet(Chev only) plastic L or R w 2 1/2 inlet each	\$8.95	\$5.00
4-415-60L	60-63 Defrost Vent Outlet (Chev & GMC) steel w/ 1 3/4 " inlet left		\$30.00
4-415-60R	60-63 Defrost Vent Outlet (Chev & GMC) steel w/ 1 3/4 " inlet right		\$30.00
4-415-64L	64-66 Defrost Vent Outlet (GMC) steel " inlet left w/2 1/2		\$30.00
4-415-64R	60-63 Defrost Vent Outlet (GMC) steel 1/2 " inlet right w/ 2		\$30.00
4-0517	64-72 Defrost Tubing w/o AC original type material 2pc 2 1/2 " dia	\$54.95	
4-0517-P	64-72 Defrost Tubing w/o AC 2 1/2 "plastic	\$32.95	
22-0209	55-63 Defrost Tubing - original type material 2" dia x 40" long	\$54.95	
22-0209-P	54-63 Defrost hose plastic 2 "	\$32.95	
	Info- dlx heater have cable control defrost & std heater have manual lever for def/floor//60-63 Def-Heater deflector box- tubing outlet are 1 3/4 " // 64-66 Def-Heater deflector box- tubing outlet are 2 1/2 " dia		
4-409-A	60-66 Air Intake Cover w/ gsk & 5 screws @ cowl	\$27.50	
4-409-B	60-66 Heater plate w/ 3 screws & gskt 5" x 5"	\$19.50	
4-409-C	60-66 Heater delete plate w/ 4 screws & gsk 6.5 x 6.5	\$21.95	
4-409-D	60-66 Heater Gasket set w/ dlx heater	\$44.95	
4-409-T	60-66 Heater Gasket kit- w/ fresh air heater	\$10.95	



Bill's Truck Shop Limited

Phone (905) 725-3460 / (905) 725-2022 / Fax (905) 404-2302 email: bill@billstruckshop.com

Heater & AC

Group 4

<u>Part No.</u>		<u>New</u>	<u>Used</u>
	HEATER BOX A/C or W/O A/C		
4-400	60-63 Standard Housing ass in cab only		Inquire
4-400-64	60-64 Standard heater assembly in cab only		Inquire
4-403	60-63 Deluxe Heater ass firewall & in cab		Inquire
4-404-F	64-66 Deluxe Heater ass w/ fresh air valve firewall & in cab		Inquire
4-404-S	64-66 Dlx heater assembly w/o fresh air valve		Inquire
	64-66 AC/Heater assembly & parts inquire as nec		Inquire
4-404-SK	64-66 Heater box screw kit-cover,housing,core support & heater motor 31 screws	\$3.75	
10-404-F	60-66 Heater Cable Grommet w/ fresh air heater oval hole @right side of heater box for cable to flapper lever round/folds into oval hole	\$5.75	

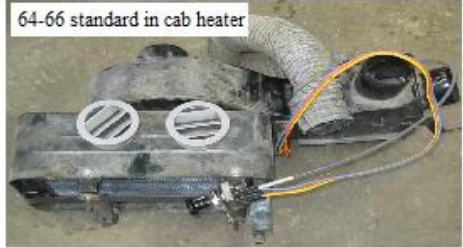

10-404-F



4-404-SK

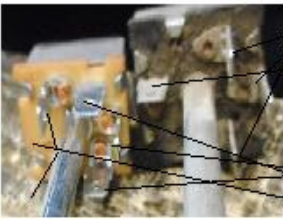

3 pin side by side w/ 1 extra

3 pin opposed w 2 extra

22-0201	<p>Heater Accessory Kit-single speed</p> <p>A compact 12 volt replacement-includes switch & cable operated defrost -does not include hose & vents 5/8 pipe outlets-2" defrost outlets -add-defrost hose #4-0051P & grommet # 18-310-G x2---use 5/8 heater hose</p>	\$289.95	
---------	---	----------	--



22-0201

Bill's Truck Shop Limited

Phone (905) 725-3460 / (905) 725-2022 / Fax (905) 404-2302 email: bill@billstruckshop.com

AC

4-0550-K AC O-Ring kit \$14.95



4-0054P Plastic AC & defrost hose 6' x 2 3/4" \$34.95

4-0055P Plastic AC & defrost hose 6' x 3" \$34.95



OPTIONAL SYSTEM UPGRADES AVAILABLE:

- Chrome Compressor upgrade
- Polished Compressor upgrade
- Trinary Switch Upgrade
- Hurricane Heat Cool & Defrost Unit-
- Electronic Slide Control
- Mounting brackets
- Duct Hose Adapters
- ABS Plastic Glove Box
- Compressor w/mounting bkt-varies w/ engine
- A/C Hose Kit
- Replica Condenser Assembly w/ custom Aluminum
- Tubes & Factory Style Receiver Drier
- In dash or under dash outlets

4-4211-F 60-63/64-66 Chev or GMC AC system Inquire



4-0051P Plastic AC & defrost hose 6' x 2" \$34.95

4-0053P Plastic AC & defrost hose 6' x 2 1/2" \$34.95

4-0054P Plastic AC & defrost hose 6' x 2 3/4" \$34.95

4-0055P Plastic AC & defrost hose 6' x 3" \$34.95



<u>Part No.</u>		<u>New</u>	<u>Used</u>
DOME LAMP			
5-0DLC	60-72 Dome Light W/ chrome housing	\$17.95	
5-0DLW	60-72 Dome Light W/ white housing	\$19.95	
5-0DLH	60-72 Dome Lamp Wiring	\$17.95	
5-0DLC-LED	60-72 Dome Light w/ clear lens ,LED bulb & harness	\$39.95	
5-0DLC-C	60-72 Dome Light lens-----CLEAR	\$11.95	
5-0DLL	60-72 Dome lamp Lens	\$4.95	
5-0211	60-72 Dome Lamp Bulb	\$1.95	
5-0HL	47-87 Hood Light Kit-OE kit	Inquire	
DASH - ASH TRAY - LIGHTER			
5-410-C	60-63 Chev Ash Tray Assembly	\$15.00	
5-410-G	60-66 GMC Ash Tray Assembly	\$20.00	
5-414-C	64-66 Chev Ash Tray assembly	\$15.00	
5-410-OH	60-63 Chev & 61-66 GMC Ash Tray Handle black approx 2 ½ long x 1 wide	\$9.95	
5-410-4H	64-66 Ash Tray Handle-black approx 4 ½ L x 9/16 wide	\$14.95	
5-410-0L	60-63 Lighter Assembly w/ deluxe knob	\$44.95	
5-410-4L	64-66 Lighter Assembly w/ deluxe knob	\$44.95	
SPEEDOMETER CABLE			
4-0SCP	47-72 Speedometer Cable plastic casing 70 " long	\$22.95	
4-0SCS	47-72 Speedometer Cable steel casing 70 " long	\$22.95	
4-0SCP-0	47-72 Speedometer Cable plastic casing 75 " long	\$32.95	
4-0SCP-1	47-72 Speedometer Cable plastic casing 85 " long	\$52.95	
4-0SCP-2	47-72 Speedometer Cable plastic casing 100 " long	\$52.95	
4-0SCP-3	47-72 Speedometer Cable plastic casing 60" long	\$59.95	
10-404-S	60-66 Speedometer Cable Grommet	\$3.50	
10-0404-S	60-66 Support-speedometer cable @ frame cross member ¼ hole ¼ insert plastic each	\$1.25	OE steel \$2.50



]

<u>Part No.</u>		<u>New</u>	<u>Used</u>
GLOVE BOX-CHEV			
5-412	60-63 Glove box liner-Chev	\$27.95	
5-412-4AC	64-66 Glove box liner Chev w/AC	\$27.95	
5-412-4	64-66 Glove box liner Chev w/o AC	\$27.95	
5-412-S	60-66 Glove box crew kit (6)	\$1.75	
5-4GHB	60-66 Glove box hinge bumper-pr-CHEV only	\$2.50	
5-412-B	66-66 Glove box hinge bushing-nylon each	\$3.25	
5-412-H	64-66 Glove box hinge Chev only	\$54.95	\$25.00
5-0GGB	47-72 Glove box door bumper kit	\$2.50	
5-0221	54-72 Glove box lock w/o key	\$26.95	
5-0222	54-72 Glove box lock w/key	\$43.95	\$15.00
5-0224	54-72 Glove box lock retainer & screw	\$3.95	
5-0223	54-72 Glove box lock gasket	\$1.50	
5-412-LS	60-66 Glove box lock striker w / screws	\$8.95	
5-413-3C	60-63 Glove box door (Chev)	\$169.95	\$100.00
5-413-4C	64-66 Glove box door (Chev)		\$100.00
5-0GBL	55-72 Glove Box Light kit	\$19.95	
5-418-G	64-66 Glove Box Door Emblem-Chev- grey w/ black letters	\$49.95	
5-418-C	64-66 Glove Box Door Emblem-Chev- chrome	\$54.95	



Bill's Truck Shop Limited

Phone (905) 725-3460 / (905) 725-2022 / Fax (905) 404-2302 email: bill@billstruckshop.com

<u>Part No.</u>	<u>GMC</u>	<u>New</u>	<u>Used</u>
5-0GBB	47-72 Glove Box Door Bumper kit	\$2.50	
5-0GBL	55-72 Glove Box Light kit	\$19.95	
GLOVE BOX-GMC			
5-412-G	60-66 Glove Box Liner (GMC)	\$26.95	
5-412-S	60-66 Glove Box Screw kit (6)	\$1.75	
5-413-G	60-66 Glove Box Door (GMC)		\$50.00
5-413-GS	60-66 Glove box door hinge spring (GMC)	\$15.95	
5-413-GK	60-66 Glove Box Door Knob (GMC) replacement w/ screw-a little larger then original	\$9.95	
5-413-H	60-66 Glove box door hinge (GMC)		\$15.00



Bill's Truck Shop Limited

Phone (905) 725-3460 / (905) 725-2022 / Fax (905) 404-2302 email: bill@billstruckshop.com

<u>Part No.</u>		<u>New</u>
	RADIO	
5-420-3DV	60-63 Dual Voice Cone Dash Speaker w/hardware 140 watts	\$89.95
5-420-4DV	64-66 Dual Voice Cone Dash Speaker w/hardware 140 watts	\$99.95
5-420-KP	60-66 Kick Panel Speaker set –Molded plastic kick panels w-6.5 triaxal speakers w/ 80 watts	\$189.95
5-420	60-66 Kick panels w/o speakers-install your own speakers	\$122.95
5-4USA- 60-2	60-63 Radio-AM/FM – new 12V ,electronic shafts, aux inputs for iPod,MP3,DVD,Satellite, seek & scan, digital clock,200 watts w/ chrome bezel & CHEV logo- fits original location w/o any modification- w/ Chev logo	\$289.95
5-4USA- 60-6	60-63 Radio-AM/FM – new 12V ,electronic shafts, aux inputs for iPod,MP3,DVD,Satellite, seek & scan, digital clock,240 watts & CD changer control w/ chrome bezel & CHEV logo-fits original location w/o any modification- w/ Chev logo	\$349.95
5-4USA-2	64-66 Radio-AM/FM – new 12V ,electronic shafts, aux inputs for iPod,MP3,DVD,Satellite, seek & scan, digital clock,200 watts w/ chrome bezel & CHEV logo- fits original location w/o any modification- w/ Chev logo	\$299.95
5-4USA-7	64-66 Radio-AM/FM – new 12V ,electronic shafts, aux inputs for iPod,MP3,DVD,Satellite, seek & scan, digital clock,200 watts w/ chrome bezel & CHEV logo- fits original location w/o any modification- w/ Chev logo w/ Bluetooth	\$499.95
5-4USA- GMC-2	64-66 Radio-AM/FM – new 12V ,electronic shafts, aux inputs for iPod,MP3,DVD,Satellite, seek & scan, digital clock,200 watts w/ chrome bezel & CHEV logo- fits original location w/o any modification- w/ GMC logo	\$289.95
5-4USA-6	64-66 Radio-AM/FM – new 12V ,electronic shafts, aux inputs for iPod,MP3,DVD,Satellite, seek & scan, digital clock,240 watts & CD changer control w/ chrome bezel & CHEV logo-fits original location w/o any modification- w/ Chev logo	\$349.95
5-4USA- GMC-6	64-66 Radio-AM/FM – new 12V ,electronic shafts, aux inputs for iPod,MP3,DVD,Satellite, seek & scan, digital clock,240 watts & CD changer control w/ chrome bezel & CHEV logo-fits original location w/o any modification- w/ GMC logo	\$349.95
5-0HAN	Amplified Electronic AM/FM Hidden Antenna— requires 12 volt-includes 80” cable- peel- stick application	\$49.95
5-0UC2	Universal Speaker kit-200 watts/8"woofer & 2 Piezo tweeters in each box-11"W x 12.5"D x 3"H- pair Great for under seat or rear parcel shelf	\$259.95



5-420-3DV



5-4USA-2



5-420-KP



5-0HAN



5-0UC2

Bill's Truck Shop Limited

Phone (905) 725-3460 / (905) 725-2022 / Fax (905) 404-2302 email: bill@billstruckshop.com

Radio

Group 5

<u>Part No.</u>		<u>New</u>	<u>Used</u>
5-420-3	60-63 Dash speaker - reconditioned	\$169.00	
5-420-3S	60-63 Dash speaker support	\$75.00	
5-420-4	64-66 Dash speaker w/support - reconditioned	\$189.00	
5-420-G	60-66 Dash Speaker w/original hardware		\$75.00
5-420-3R	60-63 Radio-Original radio rebuilt w/1 year warranty-Chev		\$250.00
5-420-4R	64-66 Radio-Original radio rebuilt w/ 1 year warranty-Chev		\$250.00
5-420-4RGMC	64-66 Radio-Original radio rebuilt w/ 1 year warranty		\$250.00
5-448-3	60-63 Radio/ Dash repair Panel Chev	\$129.95	
5-448-4	64-66 Radio/ Dash repair Panel (new tooling) Chev	\$129.95	
5-448-DP	60-2 / 63-66 Chev & 60-66 GMC Radio delete plate complete w/ hdw	\$50.00	
5-0426-G	60-72 Grommet-antenna cable	\$1.95	
5-420-3K	60-63 Radio Knob Dlx-black & stainless steel	\$11.75	
5-420-4K	64-66 Radio Knob Dlx- black & stainless steel	\$14.95	
5-426-1T	60-62 Antenna-Telescopic w/ cable, hardware & instruct	\$134.95	
5-426-3T	63-63 Antenna-Telescopic w/ cable, hardware & instruct	\$119.95	
5-426-4T	64-66 Antenna-Telescopic w/ cable, hardware & instruct	\$119.95	

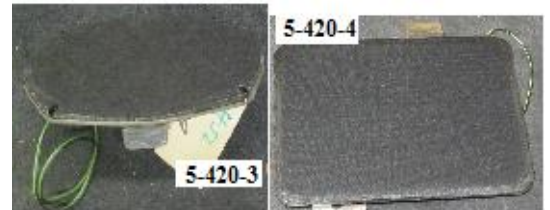

Bill's Truck Shop Limited

Phone (905) 725-3460 / (905) 725-2022 / Fax (905) 404-2302 email: bill@billstruckshop.com

Part No.		New	Used
INSTRUMENT CLUSTER & DASH			
5-430-BG	60-66 Dash Bezel GMC		\$50.00
5-430-0B	60-63 Dash Bezel (Chev)		\$25.00
5-430-4B	64-66 Dash Bezel (Chev) black	\$109.95	\$40.00
5-430-4C	64-66 Dash Bezel (Chev) chrome	\$159.95	
5-430-1C	60-66 Dash Bezel Screw kit w/ j-nuts-10pc-stainless steel Chev	\$2.95	
5-430-BG	60-66 Dash Bezel GMC		Inquire
5-430-1G	60-66 Dash Bezel screw kit 6 w/j-nuts GMC	\$8.95	
5-430-G	60-66 Gauge Decal kit w temp & fuel gauge 100 MPH (GMC)	\$28.95	
5-430-0LL	60-63 Instrunment Cluster lens w/o lower gauges NEW (Chev)	\$79.95	
5-430-0LG	60-63 Instrunment Cluster lens w/ lower gauges NEW (Chev)	\$79.95	
5-430-4LL	64-66 Instrument Cluster Lens (Chev) w/ lights	\$79.95	
5-430-4LG	64-66 Instrument Cluster Lens (Chev)w/ gauges	\$79.95	
5-450-1C	60-63 Choke Cable w/ deluxe knob	\$32.95	
5-450-1T	60-63 Throttle Cable w/ deluxe knob	\$32.95	
5-450-4C	64-66 Choke Knob-deluxe 3/16 round hole	\$11.95	
5-450-4CC	64-66 Choke Cable w/ dlx knob & retainer	\$46.95	
5-0002	Cable-universal w/o knob 66"choke-throttle etc	\$23.95	



Bill's Truck Shop Limited

Phone (905) 725-3460 / (905) 725-2022 / Fax (905) 404-2302 email: bill@billstruckshop.com



Part No.	NO WARRANTY ON GAUGES IF INSTALLED	New	Used
5-433-4T	64-66 Dash Tach 8 cyl w/ hardware ,harness & instruct -- Chev only <i>Note-</i> instrument cluster w/ gauges (G) and w/ lights (L)	379.95	
5-434-4V	64-66 Dash Vacuum Gauge		Inquire
5-435-3A	60-63 Amp Gauge (Chev)	\$87.95	\$15.00
5-435-4A	64-66 Amp Gauge (Chev)	\$96.95	\$15.00
5-435-GA	60-66 Amp Gauge (GMC)		\$40.00
5-436-3F	60-63 Fuel Gauge (Chev)	\$99.95	\$30.00
5-436-4F	64-66 Fuel Gauge (Chev) w/ gauges	\$99.95	\$30.00
5-436-4F-L	64-66 Fuel Gauge (Chev) w/ indicator lights	\$109.95	
5-436-GF	60-66 Fuel; Gauge (GMC)		\$40.00
5-437-3T	60-63 Temp Gauge (Chev)	\$110.95	\$30.00
5-437-4T	64-66 Temp Gauge (Chev)	\$96.95	\$30.00
5-437-GT	60-66 Temp Gauge (GMC) w/ C N H		\$50.00
5-438-3S	60-63 Speedometer assembly (Chev)	\$249.95	\$75.00
5-438-4S	64-66 Speedometer assembly (Chev)	\$249.95	\$75.00
5-438-GS	60-66 Speedometer (GMC)		\$60.00
5-439-3O	60-63 Oil Gauge (Chev)	\$110.95	\$50.00
5-439-4O	64-66 Oil Gauge (Chev)	\$96.95	\$30.00
5-439-GO	60-66 Oil gauge (GMC)		\$40.00
5-0LK	47-72 Oil Line Kit 5 ft copper tube w/ fittings	\$32.95	
5-0682	Block fitting for oil line	\$2.95	
18-0DB-S	47-66 Dash Bulb Socket w/new bulb contact,6" wire & crimp connector	\$9.95	

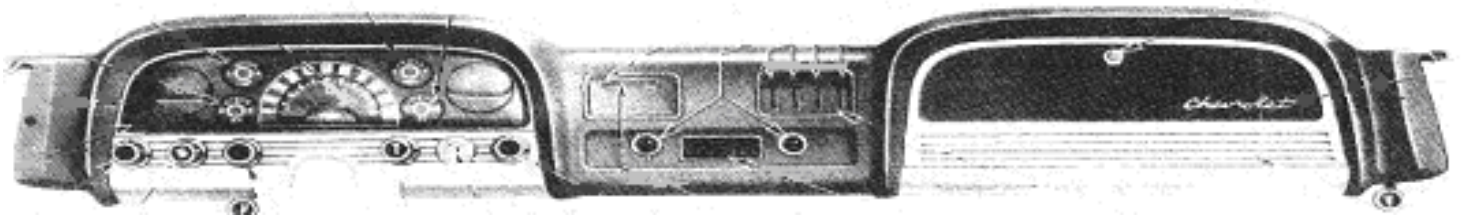
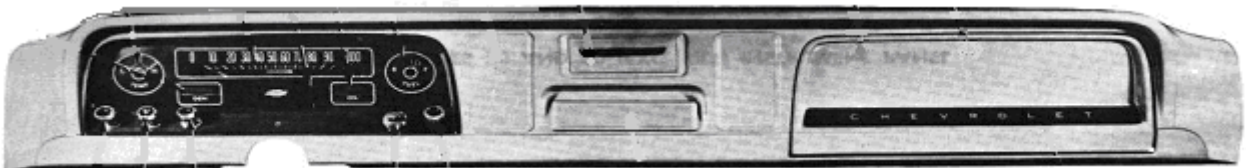
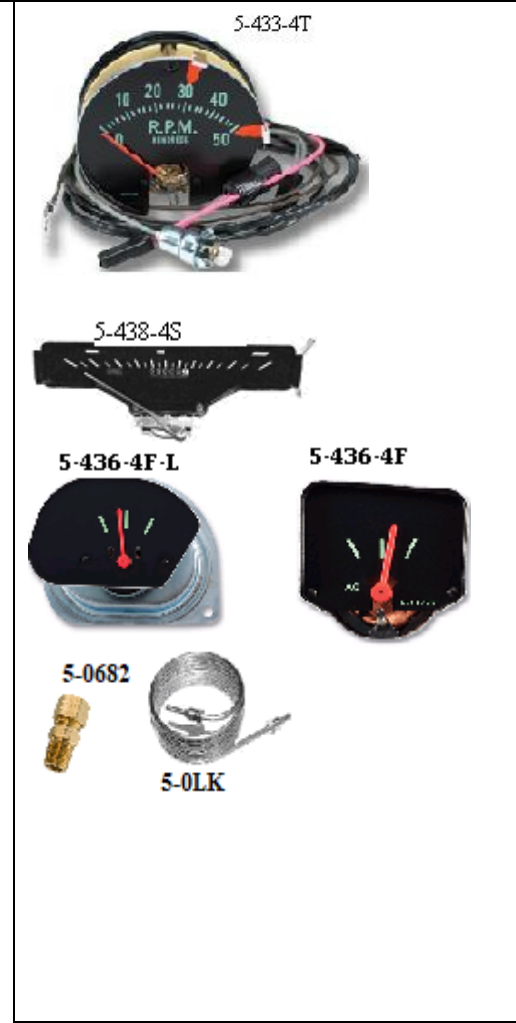

Bill's Truck Shop Limited

Phone (905) 725-3460 / (905) 725-2022 / Fax (905) 404-2302 email: bill@billstruckshop.com

Dash-GMC

INSTRUMENT CLUSTER & DASH

5-430-BG	60-66 Dash Bezel	GMC	\$50.00
5-430-1G	60-66 Dash Bezel screw kit 6 w/j-nuts	GMC	\$6.50
5-430-G	60-66 Gauge Decal kit w temp & fuel gauge		\$28.95
	100 MPH (GMC)		



5-430-BG



5-430-G

5-437-GT	60-66 Temp Gauge (GMC) w/ C N H	\$50.00
----------	---------------------------------	---------



5-437-GT



Wiper Parts

fluctuation of the Canadian and American dollars call for current prices

Group 6

<u>Part No.</u>	<u>WIPER-BRAKE SWITCH</u>	<u>New</u>	<u>Used</u>
6-403-0	60-63 Wiper Switch – single speed w/o washers		\$15.00
6-403-0W	60-63 Wiper Switch - single speed w/ washers	\$64.95	
6-403-3B	63-63 Wiper Switch - 2 speed w/ washers	\$69.95	
6-403-4A	64-66 Wiper Switch - 1 speed w/out washers		\$15.00
6-403-4C	64-66 Wiper Switch - 2 speed w/out washers		\$15.00
6-403-4	64-66 Wiper Switch - 2 speed w/ washers	\$65.95	\$15.00
6-403-3	60-63 Wiper Switch Knob-dlx-black & SS- w/o washer button hole	\$10.95	
6-403-3W	60-63 Wiper Switch Knob-dlx w/ washer button hole	\$14.95	
6-403-6	64-66 Wiper Switch Knob-dlx-black & SS- w/o washer button hole		\$5.00
6-403-6W	64-66 Wiper Switch Knob-dlx-black & SS- w/ washer button hole	\$10.95	
6-403-6SW	64-66 Wiper Switch Knob-std-black- w/ washer button hole		\$5.00
6-403-6S	64-66 Wiper Switch Knob-std-black w/o washer button hole		\$5.00
6-403-60R	60-63 Wiper Switch Retainer-stainless steel		\$10.00
6-0523	Ground washer ½ ID switch to dash	\$0.50	
6-403-R	60-66 Chev & 60-66 GMC Retainer wiper switch -stainless steel	\$12.95	
6-0506-K	60-72 Washer Jar w/ hose, cap & filter	\$29.95	
6-0506-C	60-72 Washer Cap w/ text	\$8.95	
6-0506-F	60-72 Washer Jar Filter	\$5.95	
6-0406-B	60-69 Washer Jar Support Bracket w/ hdw	\$24.95	
6-0406-HK	60-72 Hdw kit-washer jar bkt 3pcs	\$2.00	

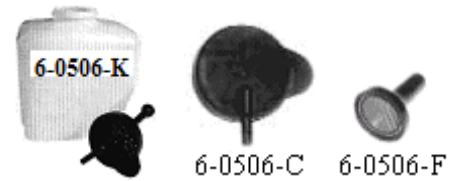
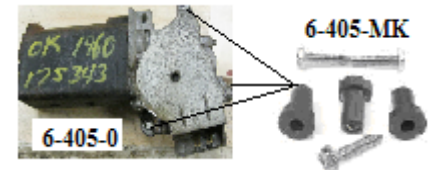
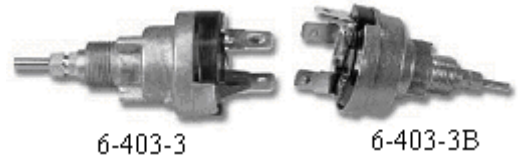

Bill's Truck Shop Limited

Phone (905) 725-3460 / (905) 725-2022 / Fax (905) 404-2302 email: bill@billstruckshop.com

Wiper Parts

fluctuation of the Canadian and American dollars call for current prices

Group 6

<u>Part No.</u>		<u>New</u>
WIPER MOTOR INFO		
2-3& 4 pin motors require 2 mount grommets #6-0405-G & 3 screws # 6-0405-S -will now include seal 6-0505-S		
6-405-0	60-63 Wiper motor kit —(lays flat to firewall)-includes harness w/ 2 speed switch & hdw no washer capability-add external pump	\$449.95
6-405-6	63-66 Wiper motor kit -(stands out from firewall)-includes harness w/ 2 speed switch no washer capability-add external pump	\$449.95
6-405-1	63-66 Wiper motor - w/ 2 pin single speed	\$199.95
6-0505-3	63-72 Wiper Motor w/ 3 pins-requires 2 mount grommets	\$169.95
6-0505-4	63-72 Wiper Motor w/ 4 pin	\$189.95
6-405-MK	60-62 Wiper motor hdw kit-- 3 inserts w/ bolts	\$9.75
6-0405-S	60-72 Wiper Screw —correct screw w/ washer	\$3.25
6-0405-G	63-87 Grommet-wiper motor mount w/ screw	\$8.95
6-0505-WP	64-72 Washer Pump Assembly-will only fit wiper motor w/ "D" shaped backing plate NOT round style see # 6-405-3-S	\$79.95
6-0505-K	Washer pump rebuild kit	\$15.95
6-0505-S	64-72 Seal-wiper motor shaft-rubber	\$9.95
6-0347	64-72 Gasket-wiper motor body	\$6.95
Windshield Washer Pump		
21-0211-U	Trico Electric (universal)	\$38.95

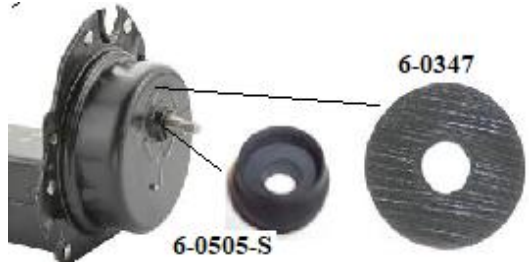

Bill's Truck Shop Limited

Phone (905) 725-3460 / (905) 725-2022 / Fax (905) 404-2302 email: bill@billstruckshop.com

988220 WINDSHIELD WASHER INSTRUCTION SHEET

ALL TRUCKS EXCEPT TILT CAB

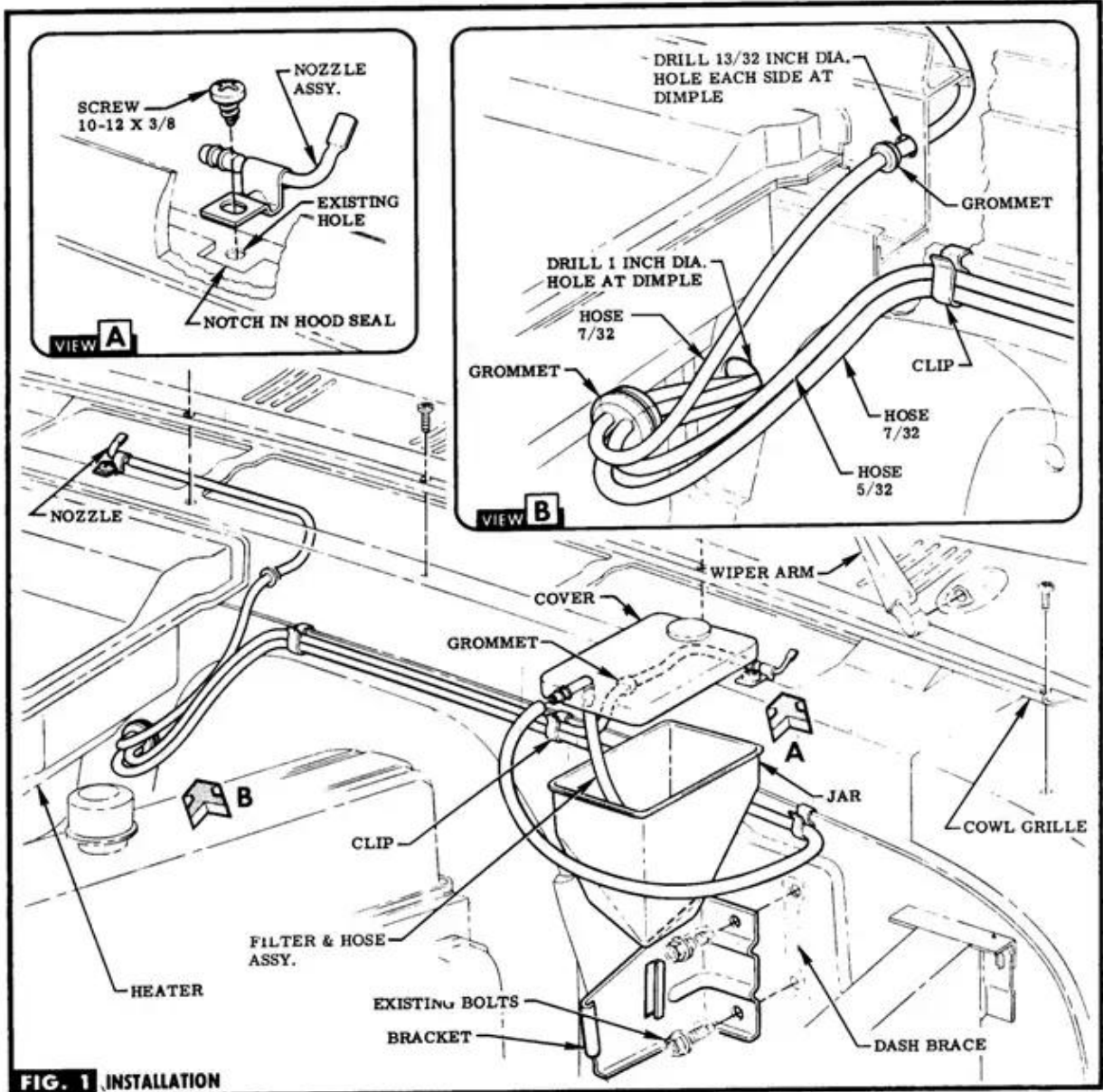

FIG. 1 INSTALLATION

- STEP 1** REMOVE COWL GRILLE & WIPER ARMS. SEE FIG. 1.
- STEP 2** INSTALL NOZZLES USING SCREWS PROVIDED. SEE FIG. 1 & VIEW A.
- STEP 3** INSTALL BRACKET USING EXISTING BOLTS. SEE FIG. 1.
- STEP 4** INSTALL JAR, COVER, FILTER & HOSE. SEE FIG. 1.
- STEP 5** DRILL LARGE GROMMET HOLE AT DIMPLE IN DASH PANEL. SEE VIEW B.

STEP 6 DRILL SMALL GROMMET HOLES AT DIMPLES IN PLENUM. SEE VIEW B.

STEP 7 ROUTE HOSES THRU SMALL GROMMETS & CLIPS & INSTALL TO NOZZLES & JAR COVER. INSTALL GROMMETS. SEE FIG. 1 & VIEW B.

STEP 8 ROUTE ALL HOSES THRU LARGE GROMMET & DASH PANEL. INSTALL GROMMET SEE FIG. 1 & VIEW B.

STEP 9 REPLACE COWL GRILLE & WIPER ARMS. MAKE SURE THAT NOZZLE GOES THRU SLOT IN GRILLE.

Wiper Parts

fluctuation of the Canadian and American dollars call for current prices

Group 6

6-405-6	60-66 Wiper Motor-replacement type w/harness & switch- 2 speed w/o washers-applies to trucks w/ straight out mount NOT angled to floor USA made	\$389.95
21-0200	47-72 Pulse wiper control 3 speed w/ washer— accepts 5-304-B bezel	\$139.95
6-405-W	60-66 Windshield Washer Nozzles w/ hdw pr	\$19.95
6-405-HK	60-66 Washer Hose kit –correct “thin wall - ribbed” hose USA made firewall or fender mount 5/32 and 7/32 hose—enough for firewall or rad support jar location	\$49.95
6-405-HS	60-66 Retainers-washer hose @ pinch weld @ firewall----3 pcs	\$12.95
10-0504-W3	60-72 Grommet-3 hole washer hose-OE replacement made in USA	\$8.95
10-0504-W	63-72 Washer Hose Grommet at cowl Fits OE thin wall washer hose only-USA made pair	\$5.95
6-407-LR	60-66 Wiper transmission assembly	\$169.95
6-407-L	60-66 Wiper Transmission left	\$40.00
6-407-R	60-66 Wiper Transmission right	\$40.00
6-407-E	60-66 Wiper Transmission arm Extension 6“ extension on right wiper trans to wiper motor arm	\$10.00
6-407-P	60-66 Wiper Motor Pivot Arm- 2/716 stepped arm from motor shaft to trans	\$10.00
7-0451-R	60-72 Retainer-wiper motor at trans arm	\$6.95
6-408-L	60-66 Wiper Arm -stainless steel left	\$19.95
6-408-R	60-66 Wiper Arm -stainless steel right	\$19.95
6-408-B	60-66 Wiper Blades stainless steel each	\$19.95
6-0602-SK	60-66 Screw kit-wiper trans 4 w/ washers	\$2.95

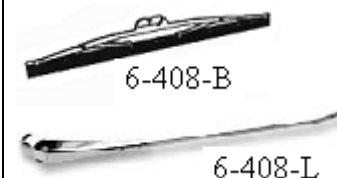

Bill's Truck Shop Limited

Phone (905) 725-3460 / (905) 725-2022 / Fax (905) 404-2302 email: bill@billstruckshop.com

<u>Part No.</u>		<u>New</u>
GAS CAPS		
6-0GCS	47-70 Gas Cap stainless steel	\$15.95
6-0GCP	47-70 Gas Cap paint to match	\$27.00
14-0416	47-70 Gas Cap chrome/lock type w/bowtie cover 60-63 w/ plastic neck w/ 7/16 cut out	\$55.95
14-0417	47-63 Gas Cap chrome/lock type smooth w/2keys-	\$22.95
FUEL TANK & PARTS		
14-0GTP	49-66 Gas Tank Insulator kit – strips 40” long	\$9.95
6-411	60-66 Fuel Sender w/ gasket-0=30 Ohm-pickup	\$49.95
6-411-SP	63-66 Fuel Sender w/ gasket lock ring style--- 0-30 Ohm w/ Blazer side fill style tank	\$59.95
6-411-BKS	63-66 Fuel sender w/ bed top fill Blazer style tank 0 – 30 Ohm 10” tall	\$48.95
14-304-PS	55-59 & 60-62 Fuel sender w/ side frame mount-panel-surburban 0=-30 Ohm-secures w 5 screws approx. 9 1/2 tall	Inquire
6-411-L	60-66 Fuel Tank Line -single 5/16 line w/grommet	\$19.95
6-0204-S	54-72 Fuel Sender pickup Screen w/ 5/16 pipe	\$28.95
6-0204-S3/8	54-72 Fuel Sender pickup screen OE metal type for 5/16 line	\$28.95
14-0593	47-66 Fuel Sender Gasket	\$2.50
14-0594	47-66 Fuel Sender Screw kit (5)	\$3.00
6-0204	47-72 Fuel Sender Float- brass	\$11.95
6-0204-S3/8	54-72 Fuel Sender pickup screen OE metal type for 5/16 line	\$28.95
6-0510-GS	60-71 Fuel Line Grommet w/ single 7/16 hole >fits 1" hole in floor	\$2.95
10-470	60-66 Fuel Neck Grommet	\$8.95
10-470-1	60-66 Fuel Neck grommet-USA made	\$14.00
14-0202-5	60-66 Fuel Inlet Hose	\$21.95
6-0415-SC	60-66 Fuel Inlet Hose Clamps –screw type pair	\$4.25
6-415-P	60-66 Fuel Inlet Pipe--steel	\$29.25
14-00GD	55-66 Fuel fill delete plate—weld in	\$23.95

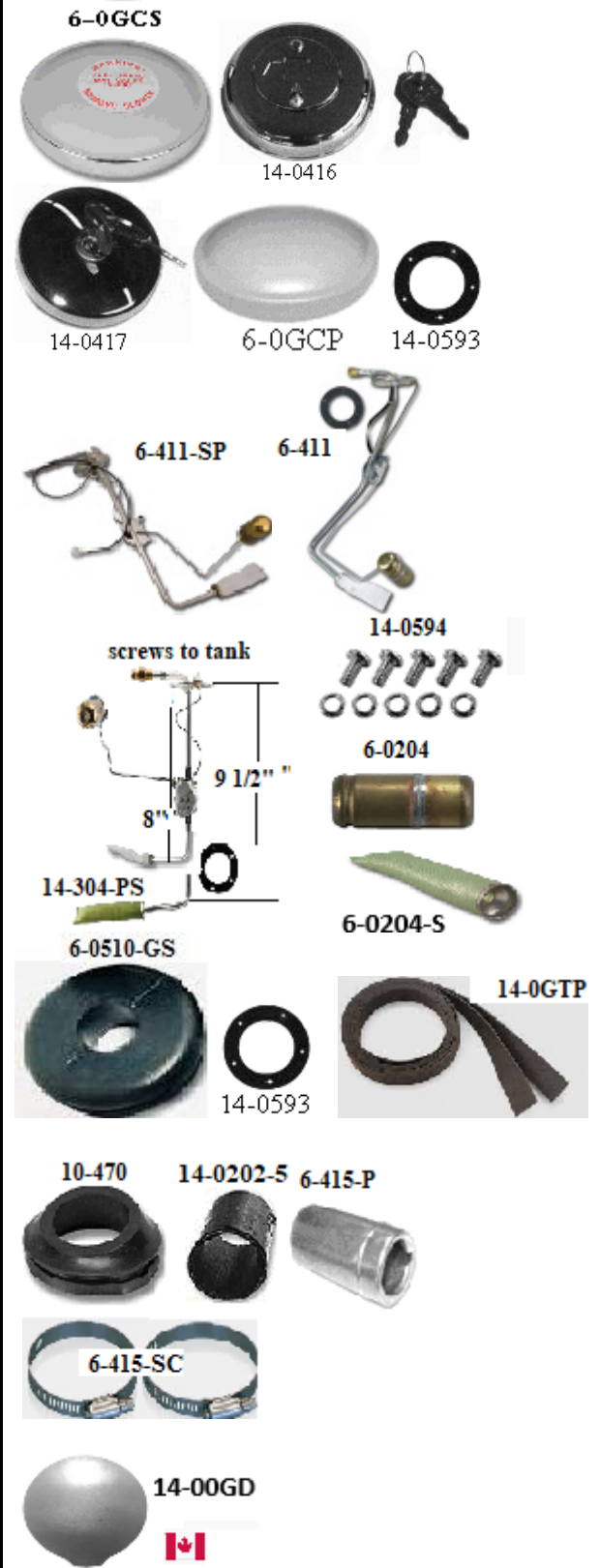

Bill's Truck Shop Limited

Phone (905) 725-3460 / (905) 725-2022 / Fax (905) 404-2302 email: bill@billstruckshop.com

<u>Part No.</u>		<u>New</u>	<u>Used</u>
	This tank kit from 69-72 Blazer & 67-72 Suburban can be installed behind the rear end of all pickup trucks- includes straps & sending unit (0-30 Ohm) With center bed fill inlet--may require relocation of rear frame bracket-cross sill -20 US - requires hose kit # #14-0FCC and fill cap # 14-00FH		
6-410-BK	63-66 Blazer style fuel tank w/bed floor fill 17 gallon/0-30 ohm fuel sender	\$399.95	
14-0FCC	Cool Cap -flush mount, billet aluminium, screw cap w/ 1 1/2 fill neck, 3" flange NON venting	\$99.95	
14-00FH	Fuel hose--neopreme 4" long x 1 1/5 ID w/ clamps	\$16.95	
6-410-K	63-66 Fuel tank kit-pickup rear frame rail 67-72 Blazer-Surburban style kit 20 gal w/ side fill -includes all hdw & 0-30 ohm fuel sender	\$399.95	
6-410	60-66 Fuel tank pickup galvanized 20 gal	\$399.95	
6-410-PS	60-66 Fuel tank panel / surburban		Inquire
6-410-S	60-66 Fuel tank straps pickop pair	\$53.95	\$25.00
6-410-SHK	60-66 Bolt kit-fuel tank pair	\$4.95	
6-0510-PTK	63-72 Fuel tank-bed fill/rear frame rail-STEEL low profile-baffles in tank 20 gal- fuel injection compatible w/ external pump-accept aftermarket fuel senders includes hdw	\$649.95	
	Universal fuel pickup/sender/adjustable to tank size		
14-0240-90	Fuel sender 90 ohm	\$59.95	
14-0240-30	Fuel sender 30 ohm	\$59.95	

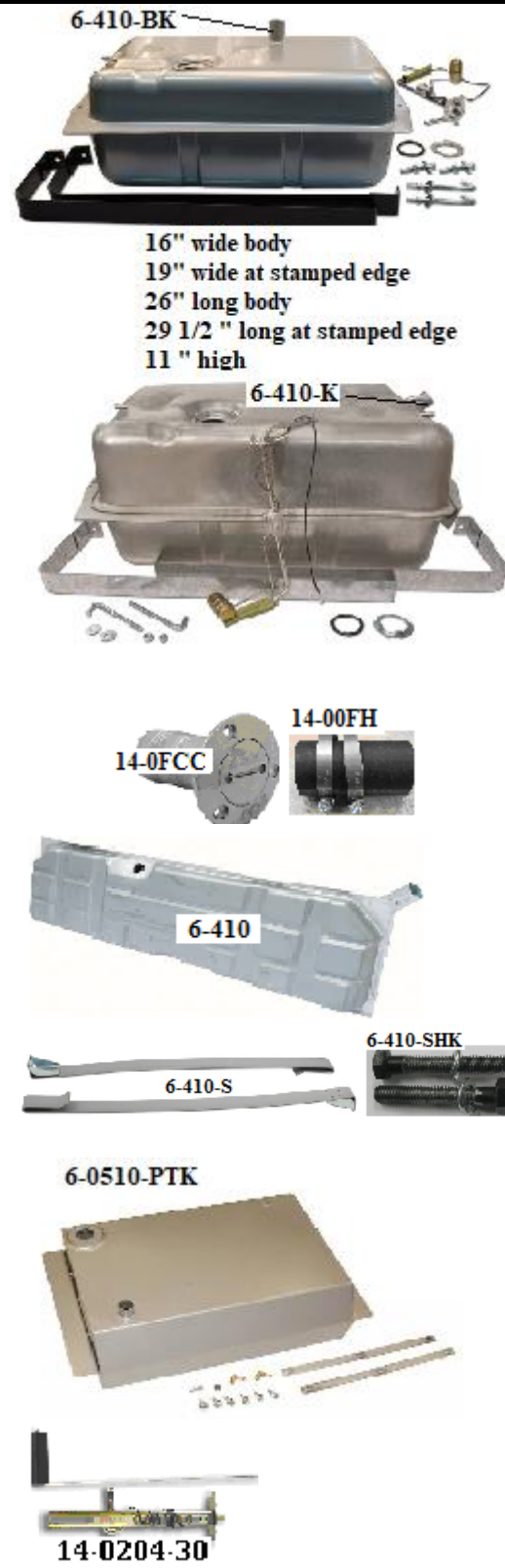

Bill's Truck Shop Limited
 Phone (905) 725-3460 / (905) 725-2022 / Fax (905) 404-2302 email: bill@billstruckshop.com

<u>Part No.</u>	<u>FIREWALL SEALS/INSULATION</u>	<u>New</u>	<u>Used</u>
	Firewall insulation original style w / die-cut holes		
7-401	60-66 Firewall Pad 2 separate pc	\$79.95	
7-401-R	60-66 Firewall Fasteners Set (7 pcs-plastic) holes may require re-drilling	\$9.95	
7-405-HS	60-66 Kick panel seal set-outer housing-pr	\$9.95	
7-405-SS	60-66 Kick Panel Vent Seal Kit-include housing and flapper seal- 4pcs /both sides	\$26.95	
7-405-S	60-66 Kick Panel Vent Seal kit-for flapper only-pr	\$6.95	
7-405-SK	60-66 Vent Housing Screw kit- 12 stainless steel	\$3.95	
7-405-60L	60-62 Cowl vent assembly-cable operated -left		\$40.00
7-405-60R	60-62 Cowl vent assembly-cable operated-right		\$40.00
7-405-L	62-66 Cowl vent assembly -lever operated left		\$40.00
7-405-R	62-66 Cowl vent assembly lever operated right		\$40.00
7-406-L	60-63 Cowl Vent Cable w/ dlx knob left	\$39.95	
7-406-R	60-63 Cowl Vent Cable w/ dlx knob right	\$39.95	
7-406-S	60-63 Grommets-cowl vent cable in housing/pr	\$4.50	

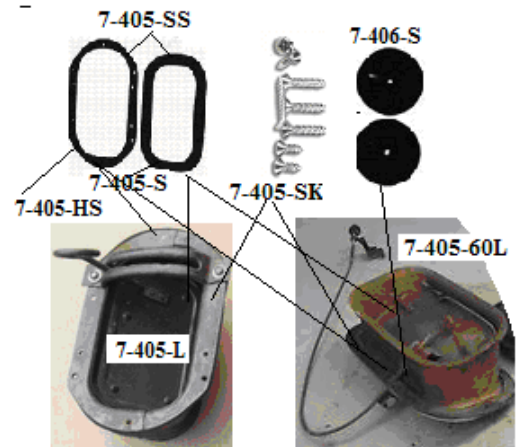

Bill's Truck Shop Limited

Phone (905) 725-3460 / (905) 725-2022 / Fax (905) 404-2302 email: bill@billstruckshop.com

PEDALS/PADS/TRIM

deluxe only accepts trim

7-0510-S	60-72 Brake /Clutch Pad standard waffle pattern each	\$4.95
7-510-D	67-72 Brake / Clutch Pad deluxe each	\$5.00
7-510-T	67-72 Trim deluxe-brake /clutch stainless steel each	\$9.95
7-414-3	60-63 Gas Pedal Pad screw on type	\$24.95
7-414-4	64-66 Gas Pedal Pad - stud type	\$17.95
7-0GPS	64-70 Gas Pedal Studs 2 required pair	\$17.95
7-0517	55-70 Accelerator Rod - pedal to cab- 6 or 8 cyl 15" w/ swivel & cotter pins	\$34.95
7-0517-S	55-70 Swivel-accelerator rod	\$5.95
7-0014	60-71 Bushing/sleeve -accelerator rod	\$4.95
7-0256	60-70 Bushings-accel arm @ firewall (may require enlarging ID) pr	\$7.95
7-415	60-66 Accelerator assembly on firewall	\$40.00
7-415-6	60-66 Accelerator arm w/ 6 cyl approx 4" long	\$40.00
7-415-V8	60-66 Accelerator arm w/ V8 cyl approx 6" long	\$32.95
7-0007	Accel spring set- inner -outer	\$9.95
Adjustable Throttle Cables		
44-0TC-24	Throttle cable 24 ' long	\$34.95
44-0TC-24-SS	Trottle cable 24" long/stainless steel	\$49.95
44-0TBS	Accel bkt w/ return springs @ carb stainless steel	\$24.94
44-0TBS-1	Accel bkt w/ return springs @ engine stainless steel	\$19.95

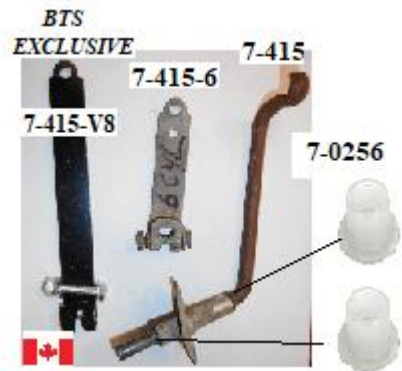

Bill's Truck Shop Limited

Phone (905) 725-3460 / (905) 725-2022 / Fax (905) 404-2302 email: bill@billstruckshop.com

FLOOR SHIFTER BOOTS ETC

A excellent replacement booth for trucks w/ original or newer 4 speed floor shift trans and 4x4 including transfer case shifter

7-520-4CK	68-70 4 Speed Shift Boot w / 6 & 8 cyl 4x4 & 6cyl C-K10 & 20	\$32.95
7-0520-RS	68-70-C-K and 73-83 C Retainer-steel w/4 speed boot	\$18.50
7-0520-RSS	68-70-C-K and 73-83 C Retainer-20 G brushed stainless steel w/4 speed boot	\$22.95
6-0FSS	47-66 Floor Shift Sponge Seal-4 speed	\$7.95
7-521	69-72 Transfer Case Shifter Boot K 5 & 10 & 20	\$32.95
7-521-RS	69-72 Transfer Case Shifter Boot Retainer K 5 10 & 20 steel w/ screw-paint to match	\$15.95
7-521-RSS	69-72 Transfer case Shifter Boot Retainer K 5 10 & 20 G brushed stainless steel w/ hdw	\$19.95

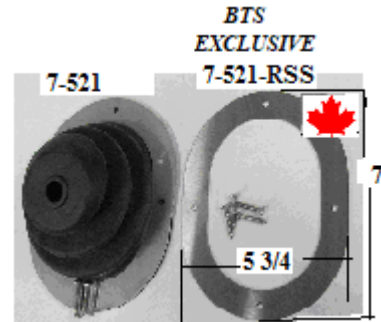
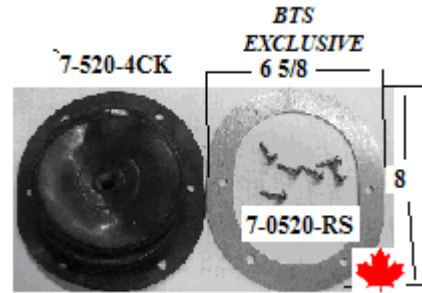

fluctuation of the Canadian and American dollars call for current prices

Part No.

New

CARPET/RUBBERMAT/TANK COVER

Carpet include felt backing, heel pad, dimmer switch ring, with bound edges & no pre-cut holes - up to gas tank Carpet must be ordered HIGH HUMP (removable trans cover) or LOW HUMP. Original colors-1 Black/2-Blue 3-Brown/4-Green/5-Red/8-Charcoal Grey, /009 Medium blue/16-Fawn-Sandlewood/18-Dark Blue/19-dark saddle/35-Dark Olive Green other colour available - special order

Add # of Colour to Part # eg 8-400-HH1

All carpet has jute backing

All carpet now comes w/the extra @ rear for no tank

8-400-HH1	60-66 Carpet w/ high hump floor - 4 speed or 4x4	\$289.95
8-400-LH1	60-66 Carpet-Black w/ low hump floor -3 speed or auto & w/ out fuel tank in cab	\$289.95
8-402	60-66 Suburban	Inquire
8-404-LH	60-63 Rubber Mat -black- up to seat w/ low hump floor SEE # 8-405-LH	NLA
8-404-HH	60-66 Rubber Mat - black- up to seat w/ high hump floor- adust clutch rod hole on 60-63	\$269.95
8-405-LH	64-66 Rubber Mat - black up to seat w/ low hump floor use on 60-63 and adjust clutch rod hole	\$289.95
8-405-HH	64-66 Rubber Mat -black up to seat w/ high hump floor -no longer available-use 60-63 and adjust clutch rod hole	NLA
8-405-P	60-66 Insulation Pad-add to rubber mat for noise reduction	\$69.95
8-408-LH	60-66 Floor Deadener Kit -Die-cut asphalt based material w/ foam liner & low hump floor	\$99.95
8-408-HH	60-66 Floor Deadener kit-Die-cut asphalt based material w/ foam liner & high hump floor	\$109.95
10782	Dimmer switch grommet (included w/ new carpet)	\$8.95
11-0HSD	Universal heat & sound insulation – 3/8 single sided foil backed w/ jute liner 4 x 6	
8-400-CW1	60-66 Rear cab wall carpet-black looppile	\$169.95
	Inquire about other colours	
8-412	60-66 Kick Panel Cover-plastic moulded/paint to match/pr	\$89.95
8-400-GT	60-66 Gas Tank Cover carpet/ see above colours---not molded-----bulk only	\$145.00
8-415-GT	60-66 Gas Tank Cover cardboard / die-cut	\$69.95

Yardage (2) carpet for rear of cab w/ gas tank removal-rear window to floor—cut pile black 801 & loop pile black 01-many colours available-call for info approx. 80” x 72 “

8-000Y-801	Cut pile -black	Inquire
8-000Y-01	Loop pile- black	Inquire

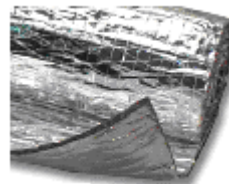
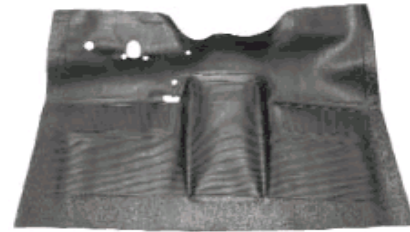

11-0HSD

10782



8-415-GT



8-412

Bill's Truck Shop Limited

Phone (905) 725-3460 / (905) 725-2022 / Fax (905) 404-2302 email: bill@billstruckshop.com

FLOOR CARPET-MAT

Group 8

<u>Part No.</u>		<u>New</u>
8-410-SSB	60-66 Step Plate w/ screws-polished stainless steel w/ out logo each	\$47.95
8-410-SSC	60-66 Step Plate w/ screws – stainless steel w/Chev logo each	\$44.95
8-410-B	60-66 Step Plate w/ screws -chrome- blank w/o logo each	\$36.95
8-410-C	60-66 Step Plate w/ screws - chrome w/Chev logo each	\$40.95
8-410-G	60-66 Step Plate w / screws- chrome w/GMC letters each	\$34.95
8-410-SK	60-66 Step Plate Screw Kit -stainless steel (12)	\$4.00

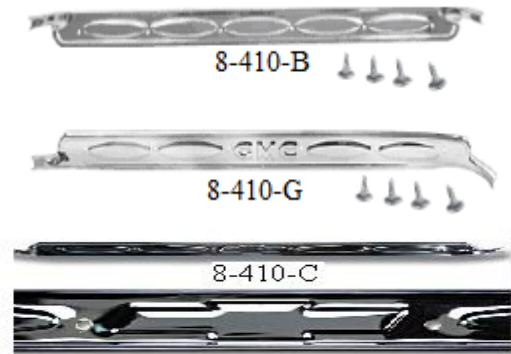

8-0130	60-87 Threshold Plates-stainless steel-2 3/4 wide x 27" long 16 gauge-304 brushed stainless steel-urethane or screw onto outer rocker panel pair	\$59.95
--------	--	---------



3-0DS-G	Grommet-dimmer switch/plastic	\$9.95
---------	-------------------------------	--------



Bill's Truck Shop Limited

Phone (905) 725-3460 / (905) 725-2022 / Fax (905) 404-2302 email: bill@billstruckshop.com

<u>Part No.</u>	<u>New</u>
SEAT COVERS	
Available in MADRID vinyl-(4001) single eg (all black) or 2 tone colour (4002) eg (black w/ white subs)—w / vertical pleats on seating area all vinyl covers are pleated	
8-4001-BK	60-66 Seat Cover black pleated \$489.95
8-4001-MG	60-66 Seat Cover medium gray pleated \$489.95
8-4001-MB	60-66 Seat Cover medium blue pleated \$489.95
8-4001-PL	60-66 Seat Cover palomino(light saddle) \$469.95
Below NO PLEATS	
8-4002-BK	60-66 Seat Cover black w/ white subs \$489.95
8-4002-MB	60-66 Seat Cover medium blue w/ white subs \$489.95
8-4002-NB	60-66 Seat Cover navy blue w/ white subs \$489.95
8-4002-MG	60-66 Seat Cover medium gray w/ white subs \$489.95
8-4002-PL	60-66 Seat Cover palomino (light saddle) w/white subs \$489.95



11-0FP	60-66 Seat Foam Pad 22 " w x 60 ' long x 3" thick extra firm foam pad -use to replace the original filler material on the rear cushion---C45 density \$89.95
11-4000-K	60-66 Installation hardware kit w/ tool \$11.95
11-4000-L	60-66 Seat Liner kit- burlap to cover foam cushion and springs prior installing cover 12 ft \$16.00



Bill's Truck Shop Limited

Phone (905) 725-3460 / (905) 725-2022 / Fax (905) 404-2302 email: bill@billstruckshop.com

INTERIOR

Group 8

<u>Part No.</u>		<u>New</u>	<u>Used</u>
Seat Frame			
8-4066-F	60-66 Seat Frame assembly		\$250.00
Seat Track			
8-4066-T	60-66 Seat Tracks w/ adjust rod		\$150.00
Seat Adjust Handle			
11-0307-H	55-66 Seat Adjust Handle w/ hdw stainless steel	\$38.00	\$5.00
8-0070	50-87 Cable-seat adjust kit w/ adjustable turnbuckle	\$12.95	
Seat Return Spring			
11-0307-S	55-80 Spring-seat return	\$11.95	



11-0209

11-0209	55-72 Tie clip-seat spring set of 3	\$2.95	
---------	-------------------------------------	--------	--

8-420-BK



11-0205-C



include w/ new visors

8-420-L



8-420-SK

SUNVISORS

Includes end clips

8-420-BK	60-66 Sunvisor-Black	each	\$49.95
8-420-T	60-66 Sunvisor-Tan	each	\$49.95
8-420-G	60-66 Sunvisor-Gray	each	\$49.95
8-420-L	60-66 Sunvisor Bracket chrome w/ hdw left		\$24.95
8-420-R	60-66 Sunvisor Bracket chrome w/ hdw right		\$24.95
11-0205-C	47-66 Visor End Clips-stainless steel	pair	\$3.50
8-420-SK	60-66 Sunvisor Screw kit	3pcs	\$0.95

Bill's Truck Shop Limited

Phone (905) 725-3460 / (905) 725-2022 / Fax (905) 404-2302 email: bill@billstruckshop.com

<u>Part No.</u>		<u>New</u>	<u>Used</u>
DOOR PANELS			
9-400-L	60-63 Door Panel left		\$150.00
9-400-R	60-63 Door Panel right		\$150.00
9-404-L	64-66 Door Panel left	\$156.95	\$100.00
9-404-R	64-66 Door Panel right	\$156.95	\$100.00
12-0324-56	56-66 Screw kit for door panel 26 stainless steel screws	\$18.95	
12-0851	56-71 Nuts-to replace missing , damaged door panel nuts-nylon push in pair	\$1.45	
9-0430-S	60-66 Door Panel Seal-- between panel & door -pr	\$11.95	
12-0IHE	47-66 Escutcheon plastic-off-white behind inter handle each	\$2.95	
12-0IHG	47-66 Inner Door Handle Gasket set	\$6.95	

ARMRESTS

Armrests are made from polyurethane foam w/ original texture & include screws.

10-0204-BK	55-65 Armrest-black	each	\$64.95
10-0204-BR	55-65 Armrest -brown	each	\$64.95
10-0204-G	55-65 Armrest-grey	each	\$64.95
10-0204-R	55-65 Armrest-red w/ beige base special order each		\$69.95
9-0564-1	60-68 Armrest-black	each	\$44.95
9-0564-5	60-68 Armrest-red	each	\$44.95
9-0564-8	60-68 Armrest-grey	each	\$44.95

9-0773-AN	47-72 Nut/ armrest cage nut	pair	\$4.95
9-0773-AS	47-72 ¼ x 20 x 1 1/4 philips screw	pair	\$2.00



12-0324-56

12-0851

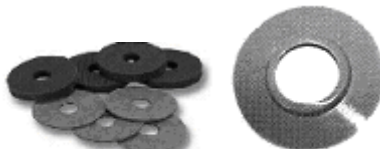

12-0IHG

12-0IHE



9-0430-S



10-0204-BK



9-0564-1



9-0773-AN

9-0773-AS

Bill's Truck Shop Limited

Phone (905) 725-3460 / (905) 725-2022 / Fax (905) 404-2302 email: bill@billstruckshop.com

Seat Belts

Group 8

<u>Part No.</u>		<u>New</u>
9-0125	60-66 Seat Belt Anchor Bolt-in OE application fine thread 7/16 x 1 1/4 grade 8 bolt w/ washer----zinc each	\$3.60
9-0SBR	Seat Belt Retractors-pr a reproduction of an OE option- for non retractable seat belts-prevents belt from falling out vehicle doors When ordering seat belts there are many issues that will have to be addressed –eg-buckets-bench-height of seat-mount location etc / note- 3 point system lock buckle must be on side of person Some applications may require an extender-see below for 6" metal ext or 12" belt extension	\$29.95
	Belt Extension w/ hdw	
SB-12XBK	black	\$21.95
SB-12XBL	navy blue	\$21.95
SB-12XR	red	\$21.95
SB-12XT	tan	Inquire
SB-12XG	gray	\$21.95
	Metal Extension	
FAB-1008-1	FAB-1008-1 1 " 90 deg " ext	\$9.95
FAB-1001-3	FAB-1001-3 8 " ext w/3 holes @ 2 1/2 apart- cut to desired length as required	\$11.95
	Seat Belts /lap style-w/ hdw.-per person Push button STD (coloured) 22"long w/female end & 38" long w/ male end // or lift lever (chrome) type DLX 22" long male end & 38" long female end-60 " DLX 42" long male end & 30" long female end-72"	
SB-N2PB	black w/ std buckle	\$74.95
SB-N2PR	red w/ std buckle	\$74.95
SB-N2PG	grey w/ std buckle	\$74.95
SB-N2PT	tan w/ std buckle	\$74.95
Sb-N2PN	navy blue w std buckle	\$74.95
SB-N2PM	maroon w/ std buckle	\$74.95
SB-N2LB	black w/chrome buckle	\$89.95
SB-N2LB-72	black w/chrome buckle 72" long	\$89.95
SB-N2LG	grey w/ chrome buckle	\$89.95
SB-N2LN	navy blue w/chrome buckle	\$89.95
SB-N2LN-72	blue w/chrome buckle 72" long	\$89.95
SB-N2LR	red w/ chrome buckle	\$89.95
SB-N2LTAN	Tan w/ chrome buckle	\$89.95



Bill's Truck Shop Limited

Phone (905) 725-3460 / (905) 725-2022 / Fax (905) 404-2302 email: bill@billstruckshop.com

SEAT BELTS

Group 8

2-point retractable w/ hdw
 Push button STD (coloured) or lift lever (chrome)
 type DLX inner is 12 " long w/ sleeve

SB-R2PB	black w/ std buckle	each	\$126.95
SB-R2PR	red w/ std buckle	each	\$126.95
SB-R2PG	grey w/ std buckle	each	\$126.95
SB-R2PT	tan w/ std buckle	each	\$126.95
SB-R2PM	maroon w/ std buckle	each	\$126.95
SB-R2PN	blue w/ std buckle	each	\$126.95
SB-R2LB	black w/ dlx	each	\$126.95
SB-R2LR	red w/ dlx	each	\$126.95
SB-R2LG	gray w/ dlx	each	\$126.95
SB-R2LT	tan w/ dlx	each	\$126.95

SB-R2LB

SB-R2PB



3-point retractable w /hdw and chrome lift latch
 (air plane style) approx 24" inner female

SB-R3LB	black w/ chrome buckle	each	\$249.95
SB-R3LDB	dark blue w/chrome buckle	each	\$239.95

3-point retractable w /hdw
 Push button STD (coloured) or lift lever (chrome)
 type DLX

SB-R3PB	black w/ std buckle	each	\$209.95
SB-R3PG	gray w/ std buckle	each	\$209.95
SB-R3PM	maroon w/ std buckle	each	\$209.95
SB-R3PT	Tan w/ std buckle	each	\$209.95



Anchor Plates

9-0160	w/ shoulder belt -7/16 fine thread /pr	\$28.95
--------	--	---------

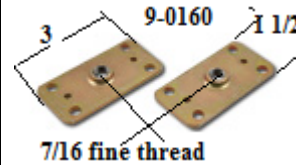

Bill's Truck Shop Limited

Phone (905) 725-3460 / (905) 725-2022 / Fax (905) 404-2302 email: bill@billstruckshop.com

CAB-BED-GROMMETS ETC

Group 10

<u>Part No.</u>		<u>New</u>
	FIREWALL/CAB-GROMMETS-SEALS	
10-404-K	60-66 Firewall Grommet kit-includes 10-404-M / E / 10-0504-P / O / 10-404-3 6 pc set	\$34.95
10-0504-P	60-72 Park Cable Grommet	\$3.25
10-404-M	60-66 Main Harness Grommet	\$5.95
10-404-E	60-66 Engine Harness Grommet	\$5.25
	<i>Note-taillight harness grommet at cab is part of harness</i>	
10-404-C	60-66 Choke Cable Grommet-3/8 located above main harness grommet <u>w/ dash lights</u>	\$2.50
10-404-3	60-66 Choke -throttle & oil line grommet 1" hole-3 hole <u>w/ dash gauges</u>	\$6.50
10-0504-B	67-72 Grommet-blank w/OE steel clip design retainer-punch hole as required	\$5.95
10-0504-W	63-72 Washer Hose Grommet at cowl Fits OE thin wall washer hose only-USA made pair	\$5.95
10-0504-W3	60-72 Grommet-3 hole washer hose-OE replacement made in USA	\$8.95
10-0504-O	60-72 Oil Line Grommet -60-66 w/out choke & throttle cables- for 1" hole USA made	\$4.95
10-404-S	60-66 Speedo Cable Grommet-1 1/16 hole @ steering column-angle entry	\$3.50
10-404-H	60-66 Heater Wire Grommet w/dlx heater-1" 60-66 Heater Cable Grommet w/ fresh air heater 3/8 oval hole @right side of heater box for cable to flapper lever round/folds into oval hole	\$4.50
10-404-F		\$5.75
10-0504-BF	64-72 Power Brake Rod Boot at firewall	\$11.95
10-0504-BB	64-72 Power Brake Rod Boot at booster w/ vent holes	\$14.95
10-0504-MB	47-72 Master Cylinder Rod Boot w/ manual brakes	\$6.00
10-0504-PB	60-72 Pedal Arm Bumper-clutch/brake each	\$9.95
10-0504-CB	64-72 Clutch Rod Boot at firewall	\$13.95
10-0504-CC	64-72 Clutch Rod Cover w /seal & screws	\$14.95
10-0504-CCP	64-72 Clutch Rod Cover-plastic push in	\$8.95
10-0909	60-72 Clutch Fork Boot at bell housing	\$14.95
6-0347	63-72 Wiper motor firewall seal	\$6.95
10-0509	60-72 Rocker Panel Plugs pair	\$1.95
10-470	60-66 Gas neck grommet	\$9.00
10-470-A	60-66 Gas neck grommet---USA made	\$16.95
3-425-L	60-66 Lower Column Seal	\$6.95
10-417-G	60-66 Grommets-battery wire to horn relay in rad support-@ battery & rad support post pair	\$4.50



Bill's Truck Shop Limited

Phone (905) 725-3460 / (905) 725-2022 / Fax (905) 404-2302 email: bill@billstruckshop.com

CAB-GROMMETS -SEALS ETC

Group 10

<u>Part No.</u>		<u>New</u>	<u>Used</u>
10-416-U	63-66 Radiator Pads - upper pair	\$16.95	
10-416-L	63-66 Radiator Pads lower 6 & 8 cyl pair	\$16.95	
10-416-LR	63-66 Radiator Pad Retainer lower each	\$14.95	
10-417-60	60-62 Radiator Support to Rad seals w/ V8	\$14.95	
10-417-63	63-66 Radiator Support to Rad seals w/ V8 63-66 Radiator Shroud Supports w/ V8	\$27.95	
10-417-K	3pc set replacement type	\$75.00	
10-417-SU	63-66 Radiator shroud upper seal support	\$15.00	\$10.00
10-417-S	63-66 Radiator shroud side support fits L & R original style	\$49.95	
10-417-L	63-66 Lower Splash Pan to Radiator Seal	\$4.50	



10-416-U



10-416-L



10-416-LR

10-417-60



10-417-63

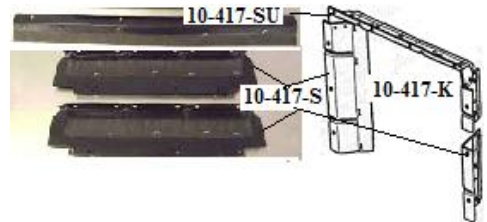

Suburban/Panel

10-430-G	60-66 Fuel Door Bumpers-pr	\$2.50	
10-0420	60-72 Rear Cross sill Taillight Harness Grommet-fleetside -cut to fit -----each	\$2.25	

10-0420



Due to the fluctuation of the Canadian and American dollars call for current prices

Bill's Truck Shop Limited

Phone (905) 725-3460 / (905) 725-2022 / Fax (905) 404-2302 email: bill@billstruckshop.com

CAB-GROMMETS -SEALS ETC

Group 10

<u>Part No.</u>			<u>New</u>	
FENDERS HDW				
10-413-3	60-63	Fender to Cab Seals	pair	\$12.95
10-413-6	64-66	Fender to Cab Seals-	pair	\$12.95
10-413-LS	60-66	Fender- seal support -vertical	left	\$69.95
10-413-RS	60-66	Fender- seal support - vertical	right	\$69.95
10-413-LB	60-66	Fender –seal support/rear upper	left	\$34.95
10-413-RB	60-66	Fender –seal support/rear upper	right	\$34.95
10-413-C	60-66	Fender to Cab Seals Clips- each (6 per side)		\$2.25
10-413-LF	60-66	Fender to cab filler bracket	left	\$18.95
10-413-RF	60-66	Fender to cab filler bracket	right	\$18.95
10-414-G	60-66	Inner Fender Grommets w/steel sleeve-pr		\$6.95
10-414-BK	60-66	Inner Fender bolt w/ washer & sleeve pr		\$12.95
10-420-S	60-66	Inner Fender Seals @ firewall w/ instructions		\$24.95
10-421-S	60-66	Seal kit-inner fender to outer & inner to rad support		\$19.95
10-420				

HOOD/FENDERS/RAD SUPPORT				
10-410	60-66	Cowl Screen to Hood Seal		\$10.95
10-410-S	60-66	Cowl Screen Screw – 7 black screws		\$4.00
10-412	60-66	Hood Brace Pad Set		\$29.95
10-412-S	60-66	Hood Latch Seal		\$12.95
10-412-SC	60-66	Clip-hood seal	each	\$3.95
10-412-1	60-61	Hood Bumper set w/ hardware		\$11.95
10-412-2	62-66	Hood Bumper set w/ hardware		\$12.95



Bill's Truck Shop Limited

Phone (905) 725-3460 / (905) 725-2022 / Fax (905) 404-2302 email: bill@billstruckshop.com

WINDOW SEALS -WEATHERSTRIPPING

Group 10

<u>Part No.</u>		<u>New</u>
WINDOW SEALS		
10-460-S	60-63 Front Window Seal std- does not accept trim	\$79.95
10-460-D	60-63 Front Window Seal dlx --accepts trim	\$79.95
10-464-S	64-66 Front Window seal- std/does not accept trim	\$74.95
10-464-D	64-66 Front window Seal dlx / accepts trim	\$79.95
1-0150-B	47-66 Rear Seal w/ black lock strip - small back window	\$49.95
1-0150-C	47-66 Rear Seal w/ chrome lock strip - small back window	\$59.95
1-05561-BB	55-66 Rear Seal w/ black lock strip ---- big back window- outer seal dia 1 1/8	89.95
1-05561-BC	55-66 Rear Seal w/ chrome lock strip- big back window-outer seal dia 1 1/8	\$89.95
1-0500	47-66 Chrome Lock Strip---- sold per ft	\$3.00

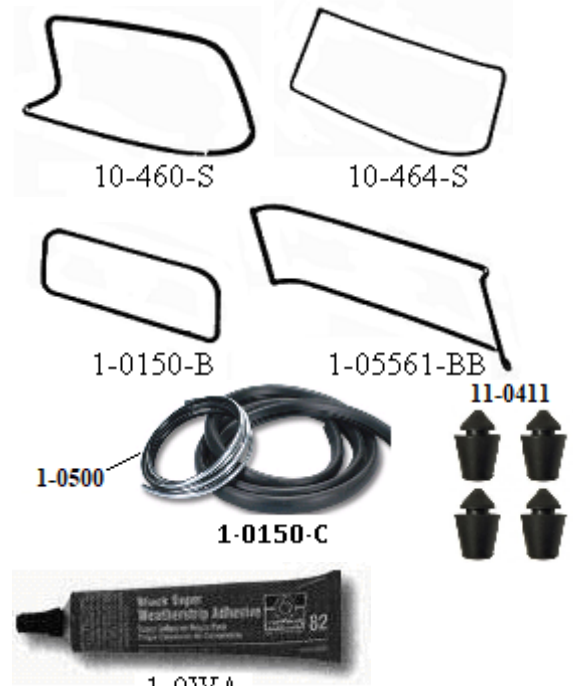

DOOR /BODY		
	-Pickup (PK) Suburban (SUB) Panel (PL)	
11-411-60	60-64 Door Bumper set w / 1/4 holes	\$8.50
11-0411	63-72 Door Bumper Set w / 3/8 holes	\$7.95
1-0WA	3-M Black Weatherstrip Adhesive	\$15.95
11-402-1K	60-63 Door Seal kit w/ pair of upper door seals 4pcs --- glue on	\$59.95
11-402-S	60-63 Door Seals-upper half of doors-pr requires 11-402-RK	\$18.95
11-402-RK	60-63 Upper Door Seal Retainers- @ each end of seal to secure to door 4 retainer w/ hdw for 2 doors	\$4.25
11-402	60-66 Door Seals glue on pair	\$49.95
	60-66 Door Seals-pr -NEW style push on-wire core to secure to cab pinch weld- no glue required	
11-402-P	60-72 Door Panel Seal-- between panel & door - pr	\$84.95
9-0430-S		\$13.95
12-0015	64-72 Door Glass Bumper set- in door bottom	\$4.95

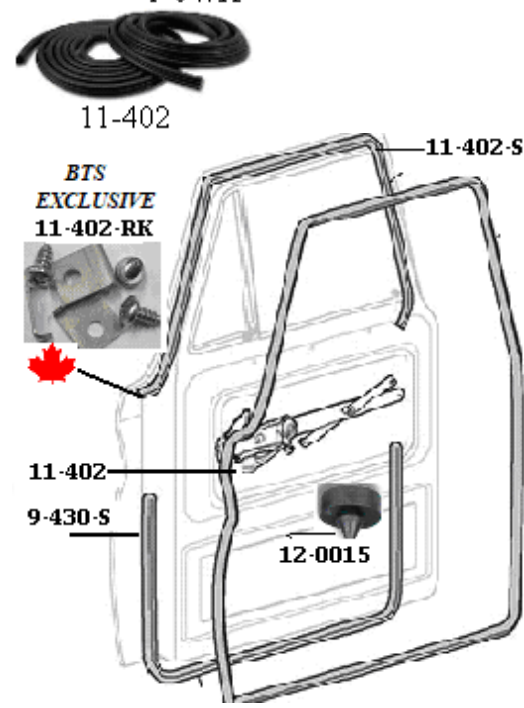

Bill's Truck Shop Limited

Phone (905) 725-3460 / (905) 725-2022 / Fax (905) 404-2302 email: bill@billstruckshop.com

WEATHERSTRIPPING

Group 11

<u>Part No.</u>		<u>New</u>
2-0303	55-63 Door Glass Channel Run w/ metal frame on glass pr	\$119.95
11-405-1	60-63 Door Glass Channel Run w/ out metal frame on glass pair	\$129.95
11-405-4	64-66 Door Glass Channel Run pair	\$49.95
11-406-0D	60-63 Door Glass Wiper kit – Dlx w/ chrome bead 4 pc	inquire
11-406-0S	60-63 Door Glass Wiper kit - Std w/ black bead	\$79.95
11-406-4D	64-66 Door Glass Wiper Kit Dlx w/ chrome bead 4 pc	\$99.95
11-406-4S	64-66 Door Glass Wiper Kit Std w/ black bead	\$94.95
11-0507	64-72 -60-63 Division Bar Liner w/out metal glass frame each	\$21.95
2-0304	55-63 Vent window division felt w/ metal framed glass-peel/stick liner pair	\$26.95
11-408-0SK	60-63 Door Glass Kit w/ out framed glass-blk wiper/chann/vert 8 pc	\$199.95
11-408-1SK	60-63 Door Glass Kit-w /framed glass-blk bead wiper/chann/vert 8 pc	\$134.95
11-408-4SK	64-66 Door Glass Kit w/ black bead wipers/chann/vertical 8 pc	\$149.95
11-408-4DK	64-66 Door Glass Kit w/ chrome bead wipers/chann/vertical 8 pc	\$159.95
12-0015	64-72 Window Stop Bumper at bottom of door pair	\$4.95
Vent Window rubber install kit-includes rivets/tool		
11-410-0	60-63 Vent Window Seal kit	\$89.95
11-410-4	64-66 Vent Window Seal kit	\$89.95
1-0VHK-55	55-63 Vent window rubber install kit	\$14.95
1-0VHK-64	64-87 Vent Window rubber install kit w/pivot rivets//tool	\$16.95
2-010	Vent Window Pivot Rivets-pr	\$6.25
11-410-P	64-66 Post-vent window w/ stainless bead & liner no brackets & holes each	\$39.95

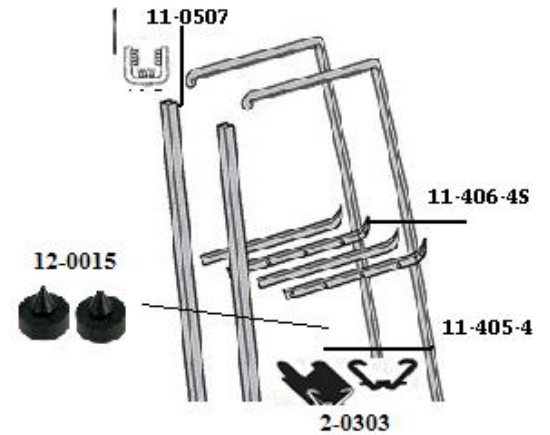

Bill's Truck Shop Limited

Phone (905) 725-3460 / (905) 725-2022 / Fax (905) 404-2302 email: bill@billstruckshop.com

WEATHERSTRIPPING

Group 11

<u>Part No.</u>		<u>New</u>
	Suburban-Panel	
11-0411-SL	55-66 Suburban- sliding side window seal kit-per window	\$149.95
11-0411-ST	55-66 Suburban -stationary side window seal-per window-non vulcanized-universal	\$79.95
11-411-SL	60-66 Suburban- front L & R ¼ sliding side window rubber seals for both sides – correct OE style w/ vulcanized corners USA made	\$359.95
11-411-SL-R	60-66 Suburban- rear L & R ¼ sliding side window rubber seals for both sides –correct OE style w/ vulcanized corners USA made	\$359.95
11-411-ST	60-66 Suburban-rear stationary L & R 1/4 side window rubber seals for both sides – correct 1 pc OE style w/ vulcanized corners USA made	\$349.95
11-412-FSK	60-66 Suburban- front glass L & R ¼ sliding side window rubber seals for both sides –correct OE style w/ vulcanized corners USA made	
11-4411	60-66 Sliding Window Latch kit-pr-stainless steel	\$119.95

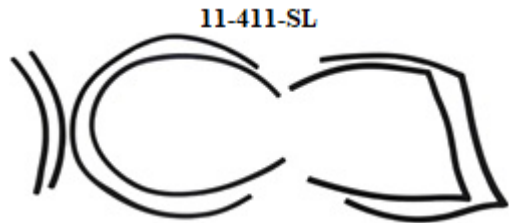
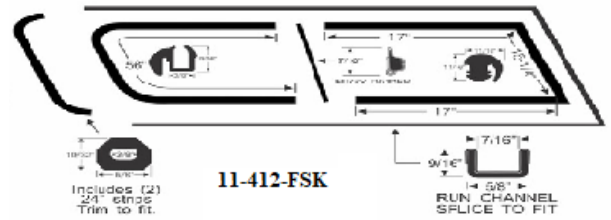

Bill's Truck Shop Limited

Phone (905) 725-3460 / (905) 725-2022 / Fax (905) 404-2302 email: bill@billstruckshop.com

WEATHERSTRIPPING

Group 11

<u>Part No.</u>	<u>Surburban-Panel</u>	<u>New</u>
11-0411-SL	55-66 Suburban- sliding side window seal kit-per window	\$159.95
11-0411-ST	55-66 Suburban -stationary side window seal-per window-non vulcanized-universal	\$59.95
11-411-SL	60-66 Surburban- front L & R ¼ sliding side window rubber seals for both sides – correct OE style w/ vulcanized corners USA made	\$359.95
11-411-SL-R	60-66 Surburban- rear L & R ¼ sliding side window rubber seals for both sides –correct OE style w/ vulcanized corners USA made	\$359.95
11-411-ST	60-66 Surburban-rear stationary L & R 1/4 side window rubber seals for both sides – correct 1 pc OE style w/ vulcanized corners USA made	\$349.95
11-412-FSK	60-66 Surburban- front glass L & R ¼ sliding side window rubber seals for both sides –correct OE style w/ vulcanized corners USA made	
11-4411	60-66 Sliding Window Latch kit-pr-stainless steel	\$119.95
11-0525-B	60-72 Cargo Dr or Hatch Glass Seal w/ black lock strip Sub/PL ---universal type	\$79.95
11-0525-C	60-72 Cargo Dr or Hatch Glass Seal w/ chrome lock strip-Sub/PL –universal type	\$84.95
11-425-B	60-66 Cargo Dr glass seals-vulcanized 1 pc OE style Sub/PL USA made pair	\$159.95
11-426-B	60-66 Rear hatch glass seal- vulcanized 1 pc OE style rubber seal Sub/PL USA made	\$159.95
1-0205-R	36-66 Rear Cargo Door Seals-universal glue on -pr	\$35.00
11-413-S	60-66 Cargo Door Seal- OE style molded w/ steel end retainers Sub/Panel w/barn doors-- pr -special order	\$469.95
11-0514-S	60-72 Cargo Door Hinge Grommets – Sub/PL set of 4	\$49.95
11-415-HG	60-66 Hatch Seal-upper & lower OE style-w/ moulded corners-ends and end mount fasteners Sub - glue on - US made pair	\$395.95
11-416-B	60-66 Lower Tailgate Bumpers-steel lined bumpers on lower tailgate and gate post -each	\$4.95
12-0500	60-72 Door plugs OE GRAY- rear gate & door hinge bolts on door and post pair	NLA
12-0500-B	60-72 Door plugs BLACK rear gate & door hinge bolts on door and post pair Plugs used on panel/surburban rear door & gate hinge bolts on pillar	\$1.95

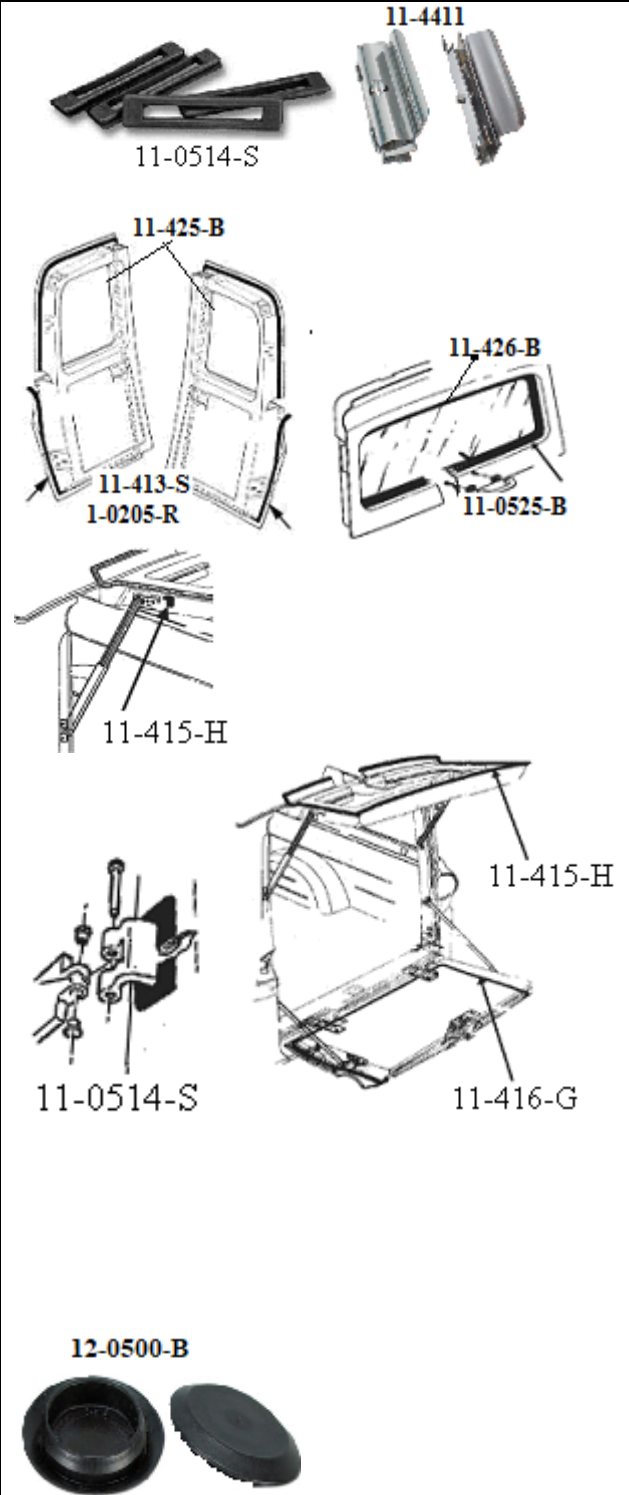

Bill's Truck Shop Limited

Phone (905) 725-3460 / (905) 725-2022 / Fax (905) 404-2302 email: bill@billstruckshop.com

DOOR & WINDOW PARTS

Group 12

<u>Part No.</u>		<u>New</u>	<u>Used</u>
DOOR/WINDOW HARDWARE			
12-0015	64-72 Window Stop Bumper at bottom of door pair	\$4.95	
12-401-L	60-63 Door Glass Frame around glass left		\$30.00
12-401-R	60-63 Door Glass Frame around glass right		\$30.00
13-0208	47-63 Door Glass Frame Screw & Barrel nut- pair	\$1.50	
	See group # 13 for complete door glass assemblies		
12-405-S1-FL	60-63 Door Glass Sash- glass support w/ framed glass -on glass lower left each		\$25.00
12-405-S1-FR	60-63 Door Glass Sash- glass support w/ framed glass- on glass lower - right each		\$25.00
12-405-S1-L	60-63 Door Glass Sash-roller guide & glass support w/o framed glass on glass lower L -each		\$25.00
12-405-S1-R	60-63 Door Glass Sash-roller guide & glass support w/o framed glass on glass lower R -each		\$25.00
12-406-64SG	64-66 Door glass sash w/ roller guide-fits L or R each	\$89.95	
13-403-64S	60-66 Sash-door glass-replace your rusty sash w/new-remove old stands & install on new sash w/ tape-fits L & R	\$24.95	
12-406-60L	60-63 Door Glass Guide- @ rear of door @ handle - left		\$25.00
12-405-60R	60-63 Door Glass Guide- @ rear of door @ handle-right		\$25.00
12-406-64L	64-66 Door Glass Guide- @ rear of door @ handle -left		\$25.00
12-406-64R	64-66 Door Glass Guide- @ rear of door @ handle-right		\$25.00
12-0505-HK	64-72 Screw kit-door glass vertical guide hdw -outer stainless screw w/ washer—also includes in lower screws	\$6.95	
12-0505-GB	60-72 Door Glass Guide Bolt- Philips drive w/ 3/4 floating washer each		\$1.00
13-0302-R	55-63 Window Regulator Roller w/ pin each set	\$4.75	
11-0510-R	64-72 Window Regulator roller w/pin each	\$2.95	
12-460-LR	60-63 Window Regulator left	\$114.95	\$30.00
12-460-RR	60-63 Window Regulator right	\$114.95	\$30.00
13-0303-G	55-63 Window Regulator Shaft & Gear w/hdw each	\$58.95	
13-0303-R	55-63 Window Regulator Guide Rail	\$35.95	\$15.00
12-472-LR	64-66 Window Regulator left	\$106.95	
12-472-RR	64-66 Window Regulator right	\$106.95	
13-0203-SK	51-72 Window Regulator Screw kit 4 bolts w/ external washers per side	\$2.75	
13-0303-S	55-87 Spring-window regulator assist fits L & R		\$5.00

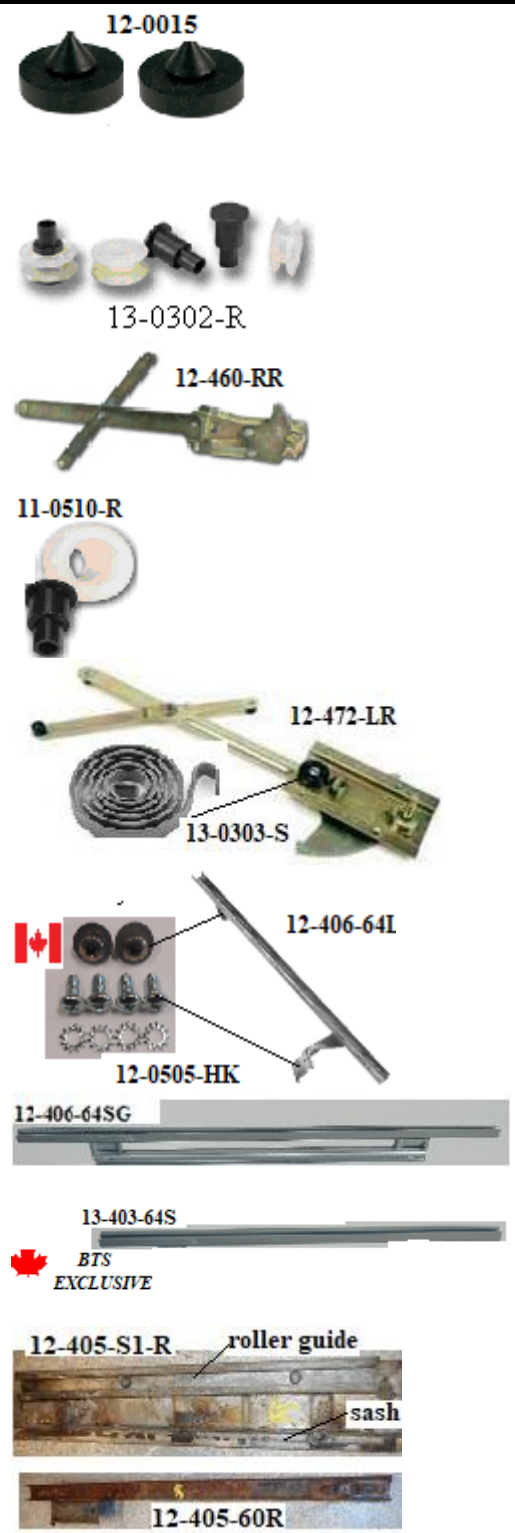

Bill's Truck Shop Limited

Phone (905) 725-3460 / (905) 725-2022 / Fax (905) 404-2302 email: bill@billstruckshop.com

DOOR & WINDOW PARTS

Group 12

<u>Part No.</u>				<u>New</u>
12-0IWH	47-66	Window Handle w/black knob	each	\$24.95
12-0IDH	47-66	Door Handle / inner	each	\$26.95
12-0IHE	47-87	Inner Handle Escutcheon grey / each		\$1.00
12-0IHG	47-66	Inner Handle Gasket set-seals & washers		\$6.95
12-460-LDC	60-63	Door Control	left	\$42.95
12-460-RDC	60-63	Door Control	right	\$42.95
12-464-LDC	64-66	Door Control	left	\$42.95
12-464-RDC	64-66	Door Control	right	\$42.95
12-0205-K	47-72	Dr Control Hdw kit- 6(zinc) screws w/ tooth washer-Philips drive	both sides	\$2.95

Power Windows- includes chrome switches, wiring harness, US made Sieman motors on original style window regulators w/ complete instructions- Brass oilite thrust bearings at pivots-also available w/ window handle control

12-460-PW	60-63	Power Window kit		\$984.95
12-460-PW-H	60-63	Power Window kit w/ crank handle switches- includes wiring		\$999.94
12-464-PW	64-66	Power Window kit		\$984.95
12-464-PW-H	64-66	Power Window kit w/ crank handle switches- includes wiring		\$999.95

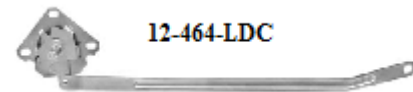

12-460-PW

Bill's Truck Shop Limited

Phone (905) 725-3460 / (905) 725-2022 / Fax (905) 404-2302 email: bill@billstruckshop.com

DOOR & WINDOW PARTS

Group 12

<u>Part No.</u>		<u>New</u>	<u>Used</u>
12-414-VFL	60-63 Vent Glass Frame -black left		\$40.00
12-414-VFR	60-63 Vent Glass Frame -black right		\$40.00
12-414-SK	60-63 Vent Window Assembly install kit – both sides	\$4.50	
12-414-LVC	60-63 Vent Frame w/SS post & chrome glass frame and clear glass left	\$559.95	
12-414-RVC	60-63 Vent Frame w/SS post & chrome glass frame and clear glass right	\$559.95	
12-414-LVT	60-63 Vent Frame w/SS post & chrome glass frame and tint glass left	\$489.95	
12-414-RVT	60-63 Vent Frame w/SS post & chrome glass frame and tint glass right	\$489.95	
12-415-LVC	64-66 Vent Frame w/SS post & chrome glass frame and clear glass left	\$499.95	
12-415-RVC	64-66 Vent Frame w/SS post & chrome glass frame and clear glass right	\$499.95	
12-415-RVT	64-66 Vent Frame w/SS post & chrome glass frame and tinted glass right	\$499.95	
12-415-LVT	64-66 Vent Frame w/SS post & chrome glass frame and tinted glass left	\$499.95	
12-415-VFL	64-66 Vent Glass Frame left		\$40.00
12-415-VFR	64-66 Vent Glass Frame right		\$40.00
12-415-SK	64-66 Vent Window Assembly install kit – both side	\$3.95	
12-0518-L	60-67 Vent Window Handle w / washer & roll pin left	\$19.95	
12-0518-R	60-67 Vent Window Handle w / washer & roll pin right	\$19.95	
13-0213-S	51-91 Spring-Vent window frame tension	\$10.95	



Bill's Truck Shop Limited

Phone (905) 725-3460 / (905) 725-2022 / Fax (905) 404-2302 email: bill@billstruckshop.com

DOOR & WINDOW PARTS

Group 12

<u>Part No.</u>		<u>New</u>	<u>Used</u>
12-460-LDL	60-63 Door Latch left	\$114.95	
12-460-RDL	60-63 Door Latch right	\$114.95	
12-464-LDL	64-66 Door Latch left	\$89.95	
12-464-RDL	64-66 Door Latch right	\$89.95	
12-0464-SK	60-72 Door Latch Screw kit -6 screws w/ washers	\$5.50	
12-0DLC	47-63 Door Latch Clip-to repair worn tumbler each	\$10.95	
12-0629-PR	52-63 Door Striker 1 st design right & left-pr	\$29.95	
12-429-L	60-63 Door Striker 2 nd design left		\$10.00
12-429-R	60-63 Door Striker 2 nd design right		\$10.00
12-429-64L	64-66 Door Striker-left	\$22.95	
12-429-64R	64-66 Door Striker-right	\$22.95	
12-429-S	64-66 Shim		
12-429-K	60-66 Door Striker Screw kit 2 nd design 4 pc		
13-0201-52	52-63 Door Striker Shim 1/8 x 1 7/16 long x 3/4 wide behind both ends of the striker for correct latch contact pair	\$5.95	
13-4063	60-63 Door striker kit 4 x 5/16-18 NC low down washer head bolts-4 washers,2 shims & 2 nut plates- per side		
12-461-L	60-63 Door Guide wedge on lower door left		\$15.00
12-461-R	60-63 Door Guide wedge on lower door right		\$15.00
12-461-S	60-63 Shim-door wedge -sets wedge to insert correctly into receiver in cab 18 gauge (0.0478" / 1.214 mm) galvanized pair	\$4.95	
12-422-L	60-66 Door Hinge upper or lower left	\$119.95	
12-422-R	60-66 Door Hinge upper or lower right	\$119.95	
12-0207-B6	60-66 Door Hinge bolt- w/floating washer-- 6 pcs	\$18.95	
12-0HPK	47-91 Door Hinge Pin 2 (11/32) pins / 4 (13/32) OS brass bushing	\$12.95	
12-0500	60-72 Door Plugs-grey on rear end of door pair	\$2.50	



Bill's Truck Shop Limited

Phone (905) 725-3460 / (905) 725-2022 / Fax (905) 404-2302 email: bill@billstruckshop.com

DOOR & WINDOW PARTS

Group 12

<u>Part No.</u>		<u>New</u>	
12-422	60-66 Door Check this check comes w/ correct 1/8 cotter pin and roll pin	each	\$18.95
12-422-HK	60-66 Door check hdw kit- 8 pcs / 2 side		\$1.50
12-422-P	60-66 Door Check Roll Pin	pair	\$1.00
12-422-S	60-63 Door Check Support on pillar post-w/ roll pin can also be used on 64-66-installs on outer post side	each	\$23.95
12-422-S64	64-66 Door Check Support Bkt -exits through cab door post	each	
12-425-1	60-66 Door Lock & Keys	1 lock	\$64.95
12-425-2	60-66 Door Lock set w / keys	2 locks	\$129.95
12-425-K	60-66 Door Lock set w/ign-glove box & 2 door locks w/ keys		\$174.95
12-427	60-66 Door Handles Outer w/ gaskets w/o key lock includes hdw	pair	\$89.95
12-0205	55-66 Door Handle & lock Gasket set		\$2.95
12-427-PS	60-66 Rear Door Handle-panel/surburban		\$34.95
12-0025-HK	55-72 Hdw kit-outer door handle 8 pcs		\$3.50

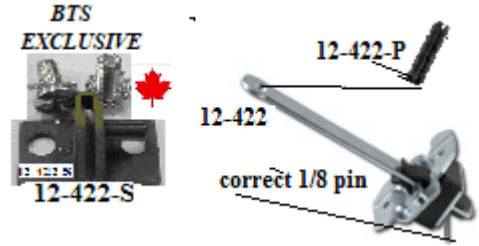

CLUTCH HEAD SCREW DRIVER SET			
5-0CHS-4	4 x screw drivers		\$34.95
5-0CHSD-4	4 x 3/8 drive sockets		\$34.95



Bill's Truck Shop Limited

Phone (905) 725-3460 / (905) 725-2022 / Fax (905) 404-2302 email: bill@billstruckshop.com

<u>Part No.</u>		<u>New</u>	
GLASS & MIRRORS			
Front & Rear glass laminated			
13-400-60T	60-63 Windshield -tinted only	\$499.95	
13-400-60TS	60-63 Windshield-tinted w/ up shade	\$524.95	
13-400-60C	60-63 Windshield – clear only	\$549.95	
13-400-64	64-66 Windshield-tinted only	\$269.95	
13-400-64T	64-66 Windshield-tinted w/shaded top	\$299.95	
13-400-64C	64-66 Windshield-clear	\$312.95	
13-400-SG	60-66 Rear Glass-smoked grey w/ small back window	\$89.00	
13-401-ST	60-66 Rear Glass tinted small back window	\$89.95	
13-401-SC	60-66 Rear Glass clear small back window	\$79.95	
13-401-LT	60-66 Rear Glass tinted big back window	\$199.95	
13-401-LC	60-66 Rear Glass clear big back window	\$169.95	
13-402-60T	60-63 Vent Glass w/green tint	each \$36.95	
13-402-60C	60-63 Vent Glass clear	each \$33.95	
13-402-64T	64-66 Vent Glass w/green tint	each \$39.95	
13-402-64C	64-66 Vent Glass w/clear	each \$33.95	
Uses 1-0GST-1 on vent glass install			
60-63 GLASS FITS FRAMED OR NO FRAMED DOOR 17" TOTAL LENGTH HIGH			
13-403-60T	60-63 Door Glass w/green tint	each \$79.95	
13-403-60C	60-63 Door Glass clear	each \$69.95	
13-403-64T	64-66 Door Glass w/green tint	each \$79.95	
13-403-64C	64-66 Door Glass clear	each \$69.95	
13-403-60CSL	60-63 Door Glass w/sash w/o glass frame/clear glass NEW ITEM !!	left \$114.95	
13-403-60CSR	60-63 Door Glass w/sash w/o glass frame/clear glass NEW ITEM !!	right \$114.95	
13-403-64CSR	64-66 Door glass w/ sash-clear	right \$189.95	
13-403-64CSL	64-66 Door glass w/ sash-clear	left \$189.95	



Windshield



Rear



Vent

Door



13-403-64CSR



13-403-60CSR

Bill's Truck Shop Limited

Phone (905) 725-3460 / (905) 725-2022 / Fax (905) 404-2302 email: bill@billstruckshop.com

GLASS-TRIM

Group 13

<u>Part No.</u>		<u>New</u>	<u>Used</u>
13-404-CS	60-66 Sliding Back Window w / black frame & clear glass small back window	\$245.00	\$100.00
13-404-CSL	60-66 Sliding Back Window w / black frame & clear glass large back window	NLA	\$100.00
Glass Setting Tape			
1-0GST	0.062 thick per foot		\$2.00
1-0GST-1	0.047 thick per foot		\$2.00
13-410-C	60-66 Rear Door Glass-panel/surb-clear-each	\$69.95	
13-410-T	60-66 Rear Door Glass-panel/surb-green tint-each	\$79.95	
13-411-C	60-66 Rear Hatch Glass-panel/surb-clear	Inquire	
13-411-T	60-66 Rear Hatch Glass-panel/surb-green tint	Inquire	



13-404-CS



1-0GST

WINDOW TRIM

10-460-T	60-63 Front Glass Trim set-stainless steel trim inserted in front window rubber NEW ITEM	\$400.00
10-464-T	64-66 Front Glass Trim- stainless steel trim inserted in front window rubber	\$299.95
	Inquire about individual pcs of trim	



Bill's Truck Shop Limited

Phone (905) 725-3460 / (905) 725-2022 / Fax (905) 404-2302 email: bill@billstruckshop.com

MIRRORS

Group 13

<u>Part No.</u>		<u>New</u>
MIRRORS		
13-410-PL	60-66 Mirror Arms painted left	\$34.95
13-410-PR	60-66 Mirror Arms painted right	\$34.95
13-410-SL	60-66 Mirror Arm stainless steel left	\$44.95
13-410-SR	60-66 Mirror Arm stainless steel right	\$44.95
13-410-GL	60-66 Mirror Arm Gasket w/moulded lip left	\$2.95
13-410-GR	60-66 Mirror Arm Gasket w/moulded lip right	\$2.95
13-0MS-A	55-70 Mirror screw OE collared style	\$6.95
13-0MS	55-70 Mirror Arm Screw Set 3 stainless screws ¼ x20 When setting the mirror head for viewing loosen the 3 set screws on back of head & tighten when in desired location-this prevents scratching the pivot ball and future rusting-also lube w/ grease	\$4.00
20-0CM	47-70 Mirror Head chrome 5" round/ribbed each	\$23.95
20-0PM	47-70 Mirror Head black 5" round/ribbed each	\$17.95
20-0SRM	47-70 Mirror Head stainless steel 8"high / 6" wide each	\$27.95
20-0PRM	47-70 Mirror Head black 8" high 6" wide each	\$24.95
13-0510-M	60-71 Anti-movement insert w/ screw	\$4.95
13-0510-B	60-71 Inside Mirror Bracket chrome w / screws-- ---- INCLUDES 13-0510-M	\$36.95
13-0510-SK	60-71 Screw kit-interior mirror—3 pcs	\$1.50
13-410	60-64 Inside mirror Head Day / Night-stainless steel 10 "	\$69.95
13-0510-DN	65-71 Inside Mirror Head Day / Night stainless steel	\$66.95
13-0510	60-71 Inside Mirror Head stainless steel	\$39.95
20-0PM-C	Peep Mirror 4" w/ curved arm -chrome L or R	\$34.95
9-0PM-S	Peep Mirror 4" w/ straight arm chrome L or R	\$36.95
13-0977	60-87 Mirror Screw- 1 stainless screw w/ jack nut-used when installing camper mirrors	\$7.50
13-0541	Adjustable swing arms-fits L or R / chrome finish/extendable 12 to 14 "/includes mount hdw-----each	\$89.95
13-0551	Mirror-camper style stainless -low mount	\$134.95
13-0450	Mirror-camper style w/ 10 " arms-stainless steel/chrome 7 ½ x 10 ½ head	\$89.95



Bill's Truck Shop Limited

Phone (905) 725-3460 / (905) 725-2022 / Fax (905) 404-2302 email: bill@billstruckshop.com

BODY & ENGINE MOUNTS

Group 14

<u>Part No.</u>		<u>New</u>	<u>Used</u>
MOUNT- BODY			
All body mount kits comes w / nuts, bolts, washers, sleeves & Instructions 10-is 1/2 ton / 20 is 3/4 ton / C is 2 wheel drive / K is 4x4 use original front bolts on 60-63			
14-0625	60-68 Rad Support Kit C & K 10-20	\$37.95	
14-4141	60-66 Cab Mount Kit polyurethane -must reuse front bolts on 60-62 C & K 10-20	\$119.95	
14-4141-B	60-66 Cab Mount Kit -original rubber style -must reuse front bolts on 60-62 C & K 10 & 20	\$119.95	
14-446-CK	60-66 Cab Mount Kit (side mount style) C 20 & K 10-20	each	Inquire Inquire
14-450-SK	60-66 Suburban/panel Body mount cushion kit NO hdw firewall back		
14-450-S	60-66 Suburban -Panel -ft cushion set only-pr	\$45.00	
14-460	60-63/64-66 Body Frame Brackets inquire by location		\$30.00
14-000S-Kit	60-72 Body mount shim kit 4 shims 14 gauge --2 rear w/ 5/8 hole & 2 front w/ 1/2 hole--galvanized	\$9.95	
14-4141-R	63-66 Rear cab frame brackets w/ hdw	each	\$45.00
14-4141-F	63-66 Ft cab frame mounts USED ONLY front each		Inquire
14-0FIS	1963-72 Reinforcement—weld in support when shorting frame 11 ga x 12 “ long pair	\$49.95	



14-0625



14-4141



14-4141-B



14-4141-D



14-4141-C



14-446-CK



14-4141-R

BTS
EXCLUSIVE



14-4141-F

Bill's Truck Shop Limited

Phone (905) 725-3460 / (905) 725-2022 / Fax (905) 404-2302 email: bill@billstruckshop.com

ENGINE MOUNTS

Group 14

<u>Part No.</u>		<u>New</u>	<u>Used</u>
14-0021	63-72 Engine Mounts 6 or 8 cyl each	\$18.00	
14-0021-P	63-72 Engine Mount Polyurethane, Zinc/Black each	\$65.00	
14-0411-6	63-72 Engine Mount Brackets 6 cyl pair		\$50.00
14-0411-8	63-72 Engine Mount Brackets 8 cyl pair Requires drilling lower mount in crossmember	\$169.95	
14-0510-M	62-72 Engine Mount big block w / hardware each	\$124.95	
14-0510-B	63-72 Engine Mount Brackets big block OE stamped design requires notching frame @ upper location & drill lower mount hole pair	\$159.95	
40-0312-G	61-62 Engine Mount-front GMC w/ V 6 or V 12 1 upper and 1 lower pair	\$99.00	
Below mounts have a side to side through bolt for replacement style frame brackets			
40-0220-M	Engine Mount rubber style each	\$21.95	
40-0220-MP	Engine mount polyurethane w/zinc frame each	\$64.95	
14-0510-SM	60-62 GM truck w/ X frame-requires spacing top frame location - 63-72 Engine Mount Brackets small block Uses 40-0220-M or 14-0220-MP engine cushion	\$169.95	
14-0214	54-87 Rear Motor Mounts w/ manual trans- 1 up & 1 lower	\$32.95	
14-0214-K	60-72 Keeper-mount bolt	\$7.95	
14-0214-S	54-72 Spacer-mount bolt	\$10.95	
14-0214-B	54-72 Bolt-mount	\$2.00	
14-0214-60K	60-72 Rear mount hdw kit 6pcs	\$26.95	
40-4337	60-66 Engine mount-GMC w/ V 6-each	\$15.95	



Bill's Truck Shop Limited

Phone (905) 725-3460 / (905) 725-2022 / Fax (905) 404-2302 email: bill@billstruckshop.com

BODY & ENGINE

Group 14

<u>Part No.</u>		<u>New</u>	<u>Used</u>
16-0472-C	63-72 Transmission Support- original 3 pcs	\$279.95	
14-025-S	63-72 Transmission Support-auto or std @rear of trans-OE style	\$179.95	\$75.00
14-025-ST	63-72 Transmission Support-auto or std @rear of trans-tube type-may require drilling on 63-66	\$149.95	
14-025	63-72 Rear Trans Mount auto& 3 or 4 speed trans	\$26.95	
14-025-1	63-72 Rear Trans Mount auto 400 trans	\$24.95	
14-0030-F-HD	63-72 Bearing Support-heavy duty aluminum housing w/ hight impact polyurethane cushion ft to rear mount	\$189.95	
14-030-S	63-72 Driveshaft Support side to side mount 1.3780" bore	\$71.95	
14-030-F	63-72 Driveshaft Support front to rear mount	\$91.95	
14-0107	65-75 Transfer Case Mount Cushion set-polyurethane w/ sleeves -can also be used w/ divorced transfer cases on 60-64 -requires 2 sets	\$42.95	
14-030-SB	54-72 Suppor- hanger bearing w/ ft to rear mount includes hdw	\$49.95	

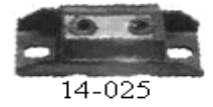
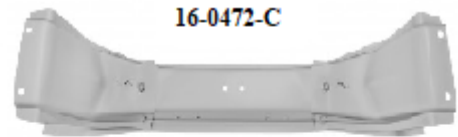

Bill's Truck Shop Limited

Phone (905) 725-3460 / (905) 725-2022 / Fax (905) 404-2302 email: bill@billstruckshop.com

SPARE TIRE

Group 15

SPARE TIRE HARDWARE

Grommet		
14-0610	55-66 for support brace in fender –short step side trucks fits 1 ¾ hole	\$7.95
14-0604-15	55-66 tire support on L fender w/ short step	\$250.00
14-0604-16	55-66 tire support on L fender w/ long step	\$250.00
14-3604	58-66 Tire support in bed---fleetside	\$75.00
14-0600	60-72 Support-spare tire cross w/o front & rear stand	\$59.95
14-0600-F	60-72 Guide-spare tire guide-front	\$12.95
14-0600-R	60-72 Guide-spare tire support-rear	\$24.95
14-0600-1	54-87 Tire Support Lock Bolt -carriage bolt style w/ upper lock plate & retainer	\$22.95
14-0600-2	54-87 Tire Support Lock Nut w/ nylon insert	\$12.95
14-0600-3	54-87 Tire Support Pivot Bolt w lock nuts	\$22.95
14-0600-4	54-87 Tire support Lock Bolt-upper lock retainer	\$0.25



14-3604

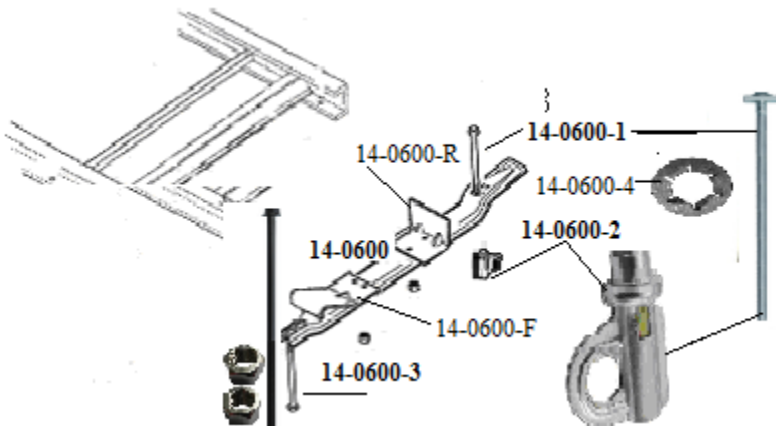

Bill's Truck Shop Limited

Phone (905) 725-3460 / (905) 725-2022 / Fax (905) 404-2302 email: bill@billstruckshop.com

STEERING –BRAKES-SUSPENSION

Group 15

<u>Part No.</u>		<u>New</u>	<u>Used</u>
SUSPENSION/STEERING-FRONT			
10-is 1/2 ton / 20 is 3/4 ton / C is 2 wheel drive / K is 4x4			
60-62/63-66 Spindles Front L or R / C 10 or C 20 each			
			\$75.00
NOTE All Spindles are US made -Cast from high quality Duct able Iron with 4140 Chrome-moly CNC machined pins-Spindles are 2 ½ drop-designed to use 71-87 2/12 5 stud rotors or our new 6 stud rotors			
15-46062-SP-OE	60-62 Stock Spindle “ w/disc brakes-OE application accepts factory ball joints and tie rod ends		
15-46062-DS-OE	60-62 Drop Spindle 2.5 “ w/disc brakes-OE application accepts factory ball joints and tie rod ends	\$475.95	
15-06370-DSOE	63-70 Drop Spindle 2.5 “ w/disc brakes-OE application accepts factory ball joints and tie rod ends	\$524.95	
15-06370-DSOE-2	63-70 Drop Spindle 2 “ w/disc brakes-OE application accepts factory ball joints and tie rod ends	\$495.00	NEW
15-571-DSOE	71-72 Drop Spindles -pr-2.5 " drop / C-10 OE application pair spindles only- when you want disc brakes w/ stock height on 63-66 trucks	\$524.95	
15-06370-SOE	63-70 Stock Disc Spindle - to convert to disc brakes –accepts factory ball joints and tie rods ends -----C /10 stock height –pr	\$475.00	
15-4061-L	60-61 Spindle left		\$75.00
15-4061-R	60-61 Spindle right		\$75.00
15-0463-L	63-70 Spindle drum brake left		\$75.00
15-0463-R	63-70 Spindle drum brake right		\$75.00
15-0193	63-87 Spindle Nut / washer & cotter pin		\$14.95
39-0221	Grease fitting ¼ -28 pipe hread-straight----		\$1.00
39-0222	Grease fitting ¼-28 pipe thread-45 deg----		\$1.50



Bill's Truck Shop Limited

Phone (905) 725-3460 / (905) 725-2022 / Fax (905) 404-2302 email: bill@billstruckshop.com

Steering & Brakes

Group 15

<u>Part #</u>		<u>New</u>	<u>Used</u>
15-414-U	60-62 Ball Joint upper C-10 each	\$77.95	
15-414-U-B	60-62 Ball Joint (off-shore) upper C-10 each	\$79.95	
15-414-L	60-62 Ball Joint lower ½ & ¾ ton each	\$124.95	
15-0414-U	63-70 Ball Joints upper C 10	\$39.95	
15-0414-U-A	63-70 Ball Joints upper C-10 US MADE	\$74.95	
15-0414-U20	63-70 Ball Joints upper C-20	\$79.95	
15-0414-L	63-70 Ball Joints lower C-10	\$39.95	
15-0414-L-A	63-70 Ball Joints lower C-10 US MADE	\$49.95	
15-0414-L20	63-70 Ball Joints lower C-20	\$57.95	
15-0560-B	63-72 Bumper ,Upper Control Arm each	\$8.50	
15-0517-B	63-72 Stud-upper control w/ lock nut-each ½ ton-each	\$14.95	
15-0517-W	63-87 Washer-convex-up control bolt-set of 4-1/2 ton	\$14.95	
19-0518-L	63-72 Support-upper control to frame-left ½ ton	\$299.95	
19-0518-R	63-72 Support-upper control to frame-right ½ ton	\$299.95	
15-0560-BP	63-91 Upper control arm bumper-polyurethane-bolt on-pr 2" tall can also be used as axle bumpers	\$36.95	
15-0561-B	60-87 Upper Control Arm Bumper-black urethane w/ screw mount stud- 1 5/8 round- 1 9/16 long pair	\$19.95	
15-417-U	60-62 Bumper ,Upper Control Arm- 2 ' tall each --use 63-72 bumpers 1 3/4 " tall	NA	
15-0517-CA10L	63-70 ½ ton upper control arm shaft has 13/16 threaded end and ¾ up has 1" threaded end and concave surface @ camber bolt	\$145.00	\$75.00
15-0517-CA10R	63-72 Control Arm w/ shaft- upper/ left C-10 - each	\$145.00	\$75.00
15-0UCA-20	63-72 Control Arm - upper/ left or right C-20 each		\$75.00
15-418-U	60-62 Shaft w/ bushings- upper control arm - C 10 each	Inquire	
15-0517-U10	63-72 Shaft w/ bushings -upper control arm, C-10 each	\$64.95	
15-0517-U10-HD	63-72 Shaft w/ bushing- upper control,C-10 heavy duty US made each	\$89.00	
15-0517-U20	63-72 Shaft w/ bushing, upper control arm C-20 each	\$64.95	
15-0517-UN20	63-72 Bushing/seal -upper control arm -& fitting ¾ @ 1 ton each	\$16.95	
15-0517-S	63-72 Seal-Upper Control Arm bushing seal C 10	\$8.95	
15-0517-S20	63-72 Seal-Upper Control Arm bushing seal C 20 & up	\$8.95	
15-418-R	60-62 Arm-lower control right		\$75.00
15-418-L	60-62 Arm-lower control left		\$75.00



Bill's Truck Shop Limited

Phone (905) 725-3460 / (905) 725-2022 / Fax (905) 404-2302 email: bill@billstruckshop.com

STEERING & BRAKES

Group 15

<u>Part No.</u>	Arms includes shaft & bushing	<u>New</u>	<u>Used</u>
15-0CA-10L	63-72 Control Arm - lower/ left C 10 each	\$399.95	\$200.00
15-0CA-10R	63-72 Control Arm - lower/ right C 10 each	\$399.95	\$200.00
15-0CA-20L	63-72 Control Arm - lower / left C 20 each		\$100.00
15-0CA-20R	63-72 Control Arm - lower /right C 20 each		\$100.00
15-0550-BP	60-62 Bumper-lower control w/ torsion ft suspension polyurethane bolt on pair	\$39.95	
15-418-LL	60-62 Shaft w/ bushing -lower control arm C10 left	\$104.95	
15-418-LR	60-62 Shaft w/ bushing -lower control arm C10 right	\$104.95	
<p>Some trucks came w/ 1/2 u-bolts In later years GM upgraded to 9/16—drill holes larger</p>			
15-0518-8	64-91 U-Bolts -lower control shaft 1/2 w/ deep nuts each	\$14.95	
15-0518-9	64-91 U-Bolts -lower control shaft 9/16 w/ deep nuts each	\$18.95	
15-0LSS-L	64-72 Shaft Seats -lower control C-10 & C-20 left each	\$21.95	
15-0LSS-R	64-72 Shaft Seats -lower control C-10 & C-20 right each	\$21.95	\$15.00
15-0518-SL	Lower Control Arm Shaft w/ bushing C10 & 20 each	\$79.95	
15-0518-LB	63-72 Lower Control Shaft Bushing ,Seal & fitting-1/2-3/4 and 1 ton each	\$18.95	
15-0518-S	63-72 Lower Control Arm Bushing Grease Seal	\$9.75	
15-0570-B	63-87 Bumper -lower control arm each	\$12.95	
15-0550-BP	60-62 Bumper -lower control arm bolt on polyurethane-pr		
39-0176	Tie Rod Boot w/ 9/16 shaft Diameter each	\$5.75	
39-0177	Tie Rod Boot w/ 5/8 shaft Diameter each	\$5.75	
15-420-I	60-62 Inner Tie Rod End each	\$89.95	
15-420-O	60-64 Outer Tie Rod end C10 L & R each	\$38.95	
15-420-S	60-64 Tie Rod Adjuster Sleeve 8 11/16 long C-10/20 each	\$23.95	
15-421-I	63-64 Inner Tie Rod End C-10 each	\$43.95	
15-0520-S	65-70 Manual & 69-70 Power Steering Tie Rod Adjuster Sleeve C-10 / 20 6" long each	\$20.95	
15-0520-O	65-70 Outer Tie Rod End L or R C-10 each	\$34.95	
15-0520-O20	65-70 Outer Tie Rod End C-20 each	\$39.95	
15-0520-I	65-70 Inner Tie Rod End L or R C-10 each	\$34.95	
15-420-KL	64-66 1/2 & 61-66 3/4 ton Outer Tie Rod End 4x4 left	\$55.00	
15-420-KR	64-66 1/2 & 61-66 3/4 ton Outer Tie Rod End 4x4 right	\$55.00	



Bill's Truck Shop Limited

Phone (905) 725-3460 / (905) 725-2022 / Fax (905) 404-2302 email: bill@billstruckshop.com

STEERING & BRAKES

Group 15

Part No.		New
15-0520-120	65-70 Inner Tie Rod End C-20 L or R each	\$54.95
15-04SC-63S	63-64 Custom Tie Rod Sleeve/ pr-for converting to 73-87 disc brakes-connects 11/16 tie rod to 5/8 tie rod 8" long pair	\$89.95
15-04SC-SA	65-70 Custom Tie Rod Sleeve/ pr-for converting to 73-87 disc brakes-connects 11/16 tie rod to 5/8 tie rod- 5 " long ALUMINUM -pr	\$129.95
15-425	60-66 Pitman Arm with manual steering C-10-20	\$79.95
15-426-0	1960-62 1/2-1 Ton and 1963-66 3/4 and 1 Ton 2 wheel drive only-----must reuse bkt on frame	
15-426-0	60-62 1/2 ton & 63-66 3/4-1- 2 ton 2 wheel drive Idler Arm - must reuse frame support	\$129.95
15-426-3	63-66 Idler Arm C-10	\$89.95
15-430-1	60-62 Power Steering Bkt kit w/ stub steering shaft , instructions and hardware	\$179.95
15-430-4	63-66 Power Steering Bkt kit w/ instructions	\$110.95
NOTE-all steering boxes have an additional \$125.00 core charge when no exchange core		
15-435-3	60-66 Steering Box manual C-10	\$325.00
15-526-PS	69-72 Pitman Arm w/ P steering C 10 & C 20 used when installing a steering box on 66 and under trucks	\$84.95
15-0535-PK	68-76 Steering Box 4x4 -rebuilt w/ flared type hose fitting-\$100.00 w/ o core note- check for rag joint application	\$495.00
15-0535-PC	68-76 Steering Box 2x2 -rebuilt w/ flared type hose fitting-\$100.00 w/ o core note- check for rag joint application	\$424.95
15-0535-PCQ	68-76 Steering Box 2x2 -rebuilt w/ flared type hose fitting-\$100.00 w/ o core 14-1 ratio quick ratio - note- check for rag joint application w/o used core	\$495.00
15-0535-PC-1	76-86 Steering Box 2x2 -rebuilt w/ o-ring type hose fitting-\$100.00 w/ o core note- check for rag joint application	\$425.00
15-0535-K	69-87 Power Steering Pitman Arm nut w/ lock washer	\$6.95
15-0404	63-67 Steering box 4x4 manual	\$395.95
15-0CORE	Steering box core charge	\$125.00
40-0055	47-72 Pitman Shaft Seal 67-72 w/ manual steering box	\$18.95



Bill's Truck Shop Limited

Phone (905) 725-3460 / (905) 725-2022 / Fax (905) 404-2302 email: bill@billstruckshop.com

STEERING & BRAKES

Group 15

<u>Part No.</u>		<u>New</u>	<u>Used</u>
	Intermediate Shaft & Flange		
40-00SF	9 ¼ long--- ¾ DD input end-becomes a slip shaft when installing ¾ DD shaft w/ rag joint flange & dust boot –accepts ¾ shaft add nec rag joint to box	\$34.95	
40-00SR	4” long ¾ round input end w/rag joint flange end-drill & pin to column shaft (recommend welding tube to shaft)	\$32.95	
15-0741	63-74 Power steering pump bracket kit 230/ 250	\$206.95	
15-0FCM	63-72 Front Crossmember		\$250.00
	Wheel Alignment Shims are galvanized steel		
15-0116	Alignment Shim 1/16 w/ 9/16 slot	each	\$0.75
15-0018	Alignment Shim 1/8 w/ 9/16 slot	each	\$1.35
15-00KIT	Alignment Shim kit 4 x 1/8 and 6 x 1/16	kit	\$8.00



15-0FCM

15-0116



Bill's Truck Shop Limited

Phone (905) 725-3460 / (905) 725-2022 / Fax (905) 404-2302 email: bill@billstruckshop.com

PULLEYS

Group 15

<u>Part No.</u>		<u>New</u>
15-0509	63-74 Pulley-single groove small block/nut on – replaces GM# 3770509	\$69.95
15-0508	Power Steering Pulley- double groove /nut secure- replaces GM# 3941107	\$69.95
15-0810	Power steering single groove-nut on-back spaced- replaces GM 3834720	\$69.95
15-0940	63-75 Nut-power steering pump	\$14.50
15-0811	Crank Pulley-double groove SB -replaces GM 3744043	\$79.95
15-0812	Crank Pulley-steel single groove SB add on for power/steering replaces GM # 3751232	\$69.95
15-0813	Crank Pulley-double groove/off set GM# 3956666AG	
15-0350	Belt-power steering belt-V8 small bock 3/8 x 35-5/8 V belt	\$19.95
50-0143-C	SB-GM Pulley-short/water pump- 7” OD/chrome	\$34.95
50-0142	SB-GM Pulley-short/water pump- 6"-2-groove- replaces GM # 3995642	\$94.95
15-0033	Power Steering Pump Pulley press on 5/8 shaft	\$58.00

15-0509



15-0810



15-0812



15-0811

15-0810

1. 11/16

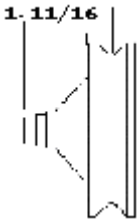

50-0142



50-0143-C



15-0350

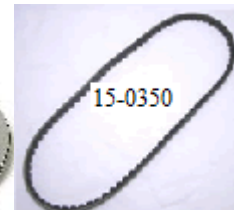

Bill's Truck Shop Limited

Phone (905) 725-3460 / (905) 725-2022 / Fax (905) 404-2302 email: bill@billstruckshop.com

STEERING-SUSPENSION

Group 15

<u>Part No.</u>		<u>New</u>
	Power Steering Pump 6 & 8 Cyl - REBUILT w/ nut on shaft	
15-0160	NO pulley w/ 8 clock down return pipe Power steering pump REBUILT w/ nut on shaft w/ 8 clock & down return pipe 15-0540-R1	\$169.95
15-0168-R	cannister outlet NO pulley	\$159.95
15-0168	Power steering pump w/ nut on shaft w/7 o clock down return no pulley includes cap NEW	\$249.95
15-0540-R	68-72 Reservoir-steering pump-9 o'clock return	\$49.95
15-0540-R1	68-72 Reservoir steering pump -7 o'clock outlet	\$49.95
15-00PS	Power Steering Fluid- 1 litre	\$9.95
15-0140	Power Steering Pump Seal kit- seals and o-rings	\$34.25
15-0540-FV	58-74 Power steering pump flow valve w/ flare pipe	\$19.95
15-0581	58-98 Cap-power steering pump	\$10.95
15-0140	Power Steering Pump Seal kit- seals and o-rings	\$34.25
15-0140-A	Power steering pump housing seal kit- o-rings only	\$14.95
15-00HN	Nut-power steering pump w/ nut on pulley replacement	\$0.75
15-0940	63-75 Nut-power steering pump OE style	\$14.50
15-0059	Hose-power steering return 18" x 3/8 ID	\$10.00
15-0540-RL	68-77 Power Steering Box Return Pipe w/ flared end w/ 20" hose	\$54.95
15-540-HC	68-72 Hose- power steering w / mail fittings on both ends 70-72 6 cyl K5 10 & 20 and 68-72 8 cyl C 10 & 20	\$59.95
15-0605-K	60-75 Power Steering Hose kit- 1 return pipe w/ 20' hose & 1 pressure hose 25" long w/ flared ends	\$104.95

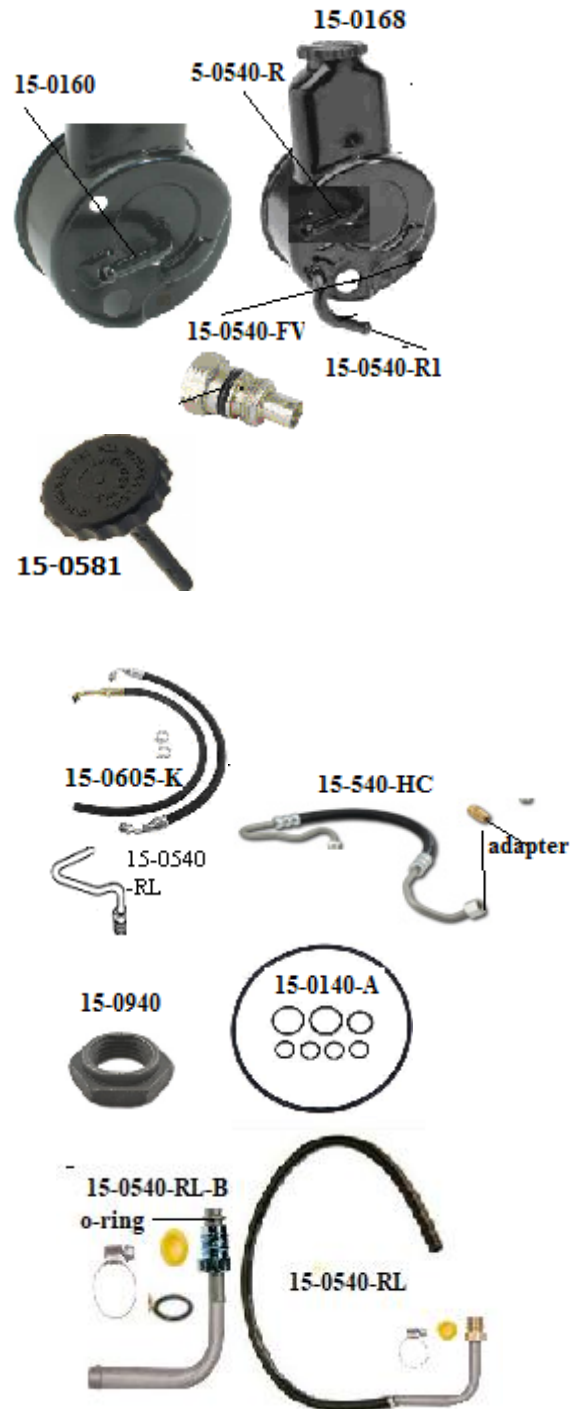

Bill's Truck Shop Limited

Phone (905) 725-3460 / (905) 725-2022 / Fax (905) 404-2302 email: bill@billstruckshop.com

STEERING-SUSPENSION

Group 15

<u>Part No.</u>		<u>New</u>
	<i>For coupler application-count splines on 1/2 and double</i>	
15-0537-M	60-68 Steering Coupler Joint manual C/K10&20 3/4 30 w/o flat side	\$79.95
15-0537-P1	68-76 Steering Coupler w/power 3/4 shaft w /36 splines	\$99.95
15-0537-P2	68-76 Steering Coupler w/power 3/4 shaft w /30 splines	\$99.95
15-0537-P	69-76 Steering Coupler w/power - 13/ 16 shaft/ 36 splines	\$99.95
15-0537-K	60-87 Steering Coupler Joint repair kit manual & power	\$27.95
15-0537-P3	Steering Coupler 1" DD x 3/4 -36 splines	\$114.95
15-0301	Power Steering Pump Bracket kit-universal works w/ short & long neck water pumps-small block V8	\$94.95
15-0301-C	Power Steering Pump Bracket kit-universal works w/ short & long neck water pumps-small block V8-CHROME	\$129.95
15-0PMK-8	64-72 Power Steering Pump Mount Kit exact copy of OE GM SB 8cyl w/8 x 1 1/4 balancer -short neck water pump	\$139.95
15-0PMK-BB	66-72 Power Steering Pump Mount Kit big block w/ short neck water pump	\$105.95
15-0540-BB-P	66-72 Power steering pump w/ REMOTE reservoir (not included) w/ big block -requires nut on pulley	\$285.00
15-0540-BB-R	66-72 Power steering pump REMOTE reservoir w/ big block-includes cap	\$99.95
15-0540-BB-H	66-72 Hose-reservoir to pump w/ clamps 20"	\$27.95



Bill's Truck Shop Limited

Phone (905) 725-3460 / (905) 725-2022 / Fax (905) 404-2302 email: bill@billstruckshop.com

STEERING & BRAKES

Group 15

<u>Part No.</u>		<u>New</u>
SWAY BARS		
15-46062-K	60-62 Sway bar kit 1.125 dia	\$274.95
15-0550-K	63-87 Sway bar 1 1/8 OE style w/ bushings--- may require drilling frame mount holes for bkts	\$329.95
15-0550-PK	63-87 Sway Bar Bushing Kit/polyurethane w/ bkts, 1 1/8 pr replacements for above sway bar	\$39.95
15-0550-K2	63-87 Ft Sway Bar kit w/ poly bushings 1 1/4 " bar 2x2 trucks end link style	\$324.95
15-0550-FB	63-87 Front sway bar bkts w/ stock height suspension pair	\$39.95
15-0550-FBL	63-87 Front Sway Bar Bkts-for trucks lowered more then 3" pair	\$39.95
15-0549-PK	63-87 Sway Bar Bushing Kit-polyurethane w/ bkts-1 " pr	\$39.95
15-0549-R	65-87 Sway Bar Bushing- OE rubber w/1 " bar each	\$11.95
15-0549-RB	65-87 Sway Bar Bracket - OE style w/1 " bar each	\$9.95
15-0550-PK	63-87 Sway Bar Bushing Kit/polyurethane w/ bkts, 1 1/8 pr	\$39.95
15-0551-PK	63-87 Sway Bar Bushing Kit-polyurethane w/ bkts - 1 1/16 pr	\$44.95
15-0551	63-87 Sway bar bushings - polyurethane for original 1" wide retainers 1 1/16 pr OE sway bar	\$22.50
15-0552-PK	63-87 Sway Bar Bushing Kit-polyurethane w/ brackets -1 1/4- pr	\$39.95
15-0552	63-87 Sway Bar Bushing -polyurethane w/ 1 1/4 dia pair	\$34.95

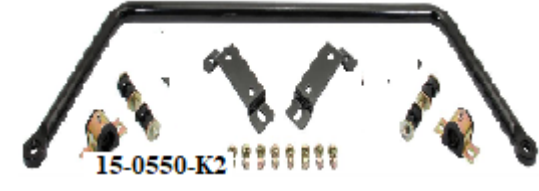
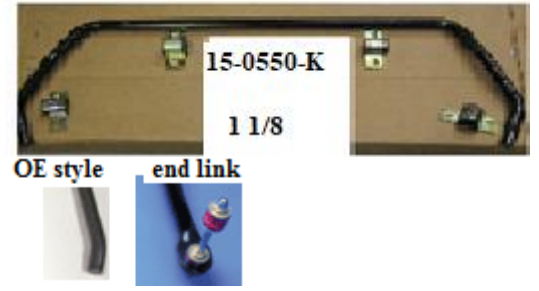

Bill's Truck Shop Limited
Phone (905) 725-3460 / (905) 725-2022 / Fax (905) 404-2302 email: bill@billstruckshop.com

STEERING & BRAKES

Group 15

<u>Part No.</u>		<u>New</u>	<u>Used</u>
	All shocks are gas pressurized shocks		
15-0039	63-72 Front Shock-stock height and or lowered w 1" or 2" coils 14 " long—10 " short	\$69.95	
15-0039	61-62 Front Shock-stock each	\$69.95	
15-0200	60-62 Front lowered-1"- 2" w/coil springs each	\$49.95	
15-0200	63-72 Front lowered 3 " w/ coil springs each	\$49.95	
15-0FSR	63-72 Ft shock relocater kit-side frame mount	\$69.95	
15-0FSR-T	63-72 Ft shock relocater kit-top frame mount	\$69.95	
15-0590	60-87 Shock Bolt w/ hdw-lower rear each	\$9.50	
15-0470	60-87 Shock Support Bolt-front upper-each	\$12.95	
15-0471	60-87 Shock Bolt -1/2 x 2 1/2 w/ lock washer & nut-each-lower front & upper rear	\$3.45	
15-06372-S	63-72 Front Coil Springs-stock C10 w/ 6 cyl or small block V8	\$239.95	\$75.00
15-06372-1	63-72 Front Coil Springs 1" drop- C10	\$189.95	
15-06372-2	63-72 Front Coil Springs-3 " drop pr C10	\$189.95	
15-06372-3	63-72 Front Coil Springs-3 " drop pr C10	\$189.95	
15-06372-C20/2	63-72 Front Coil Springs-2 " drop pr 20	\$189.95	



Bill's Truck Shop Limited

Phone (905) 725-3460 / (905) 725-2022 / Fax (905) 404-2302 email: bill@billstruckshop.com

<u>Part No.</u>		<u>New</u>	<u>Used</u>
	Rear trailing are the same from 60-72 left or right other then the park cable support bkt-below have the correct 67-72 cable support-		
16-0RTA-L	60-72 Rear Trailing Arms C-10 & C-20 left	\$389.95	\$200.0
16-0RTA-R	60-72 Rear Trailing Arms C-10 & C-20 right	\$389.95	\$200.0
16-0RTA-1	60-72 Rear Trailing arm set square tube design w/ bushings- pair		
16-0285	60-72 Rear Trailing Arm Bushing original type each	\$24.95	
16-0285-PK	60-72 Rear Trailing Arm Bushing polyurethane kit	\$49.95	
29-0285-B	60-72 Rear Trailing Arm Bolt w/ hardware 4"x3/4" @ front support each	\$9.95	
16-0072-AS	60-72 Rear Trailing Arm Seats- w/ coil rear springs pair	\$79.95	
16-0228	60-72 Rear Axle U-Bolt w/ nuts & washers-C10 / 20 each	\$34.95	
16-0228-13	60-72 Rear axle U-bolt w/ nuts & washers C10/20 13' long when additional drop blocks w/ 4" treaded length	\$39.95	
16-0289-L	60-63 Rear Arm & shock Support Bkt left		\$30.00
16-0289-R	60-63 Rear Arm & shock Support Bkt right		\$30.00
16-0411-L	64-72 Rear Arm & Shock Support Bkt C10 & C20 left	\$48.95	\$10.00
16-0412-R	64-72 Rear Arm & Shock Support Bkt C10 & C20 right	\$48.95	\$10.00
16-06072-S-HD	60-72 Rear Springs-stock 3/4 ton pickup & 1/2 -3/4 ton Surburban also on 1/2 ton for tailer towing pair	\$289.95	
16-06072-S	60-72 Rear Springs-stock C-10 (constant rate) pr	\$279.95	100.00
16-0603-2	60-72 Rear Coil Springs --2" drop C-10 pair	\$199.00	
16-0603-3	60-72 Rear Coil Springs --3" drop C-10 pair	\$199.00	
16-0603-4	60-72 Rear Coil Springs—4" drop C-10 pair	\$189.00	
16-0603-5	60-72 Rear Coil Springs—5" drop C-10 pair	\$189.00	
16-0603-6	60-72 Rear Coil Springs—6" drop C-10 pair	\$189.00	
16-0512-L	60-72 Retainer Bolt w/ hardware lower 5"x 1/2" -each	\$3.95	
16-0512-U	60-72 Retainer Bolt w/ hardware upper each	\$2.25	
16-0511-K	60-72 Coil Spring Retainer kit 4 retainers w/ bolts	\$74.95	
16-0512-L	60-72 Retainer Bolt w/ hardware lower 5"x 1/2" -each	\$3.95	
16-0RPS-4	60-72 Shim—4 deg rear pinion angle shim w/ coil rear springs aluminum pair	\$64.95	
16-0RPS-2	60-72 Shim—2 deg rear pinion angle shim w/ coil rear springs aluminum pair	\$54.95	



Bill's Truck Shop Limited

Phone (905) 725-3460 / (905) 725-2022 / Fax (905) 404-2302 email: bill@billstruckshop.com

<u>Part No.</u>		<u>New</u>	<u>Used</u>
39-0218	47-62 Axle Bumper Rear	\$9.00	
16-0875-C	63-72 Rear Axle Bumpers C10 & 20 w coil springs each	\$13.95	
16-0875-L	63-72 Rear Axle Bumpers C10 & 20 w / leaf springs each	\$21.95	
16-4021	60-62 Track bar-adjustable w/ poly bushings 34 "	\$119.95	\$40.00
16-464ATB	63-64 Track Bar - adjustable bar w/ poly bushing 26" to 28" long C-10	\$119.95	
16-072ATB	65-72 Track Bar -adjustable bar w/ poly bushings 22"to 24" C10	\$119.95	
16-072-TB	65-72 Track Bar original C-10 or C-20	\$79.95	\$40.00
16-0280-C10	60-72 Track Bar Bushing - original rubber C10 each	\$26.95	
16-0280-C20	60-72 Track Bar Bushing - original rubber C20 each	\$22.95	
16-0280-PK	60-72 Track Bar Bushing Kit polyurethane C-10 kit	\$26.95	
16-0280-20PK	60-72 Track Bar Bushing Kit polyurethane ¾ kit	\$24.95	
16-04TS	65-72 Track Bar Axle Stud w/ hardware	\$39.95	\$20.00
16-04TB	65-72 Track Bar bolt @ frame C 10 / 20	\$3.95	
16-0280-C20	60-72 Track Bar Bushing - original rubber C20 each	\$22.95	
16-4021-60A	60-62 Deluxe Rear End Conversion Trac Bar kit-secures to R trailing arm -ideal for trucks lowered more than 4 " or adding kater style rear end w/ poly bushings	\$199.95	
16-0021-A	63-72 Deluxe Rear End Conversion Trac Bar kit-secures to R trailing arm -ideal for trucks lowered more than 4 " w/ poly bushings-no welding required-bent bar for more axle cover clearance	\$239.95	
16-0021	65-72 Deluxe Rear End Conversion Trac Bar kit-secures to R trailing arm -ideal for trucks lowered more than 4 " or adding later style rear ends w/ poly bushing	\$204.95	
16-072RCK	63-72 Rear End Conversion Trac bar kit-allows you to install any 3" tube rear end-eg 73-87 truck rear end that is 61" wide-includes weld on trailing arm seats and adjustable track bar w/ weld on brackets	\$249.95	
16-07401-C	63-72 Rear Sway Bar kit w/ coil springs	\$269.95	
16-0951-L	63-72 Rear Sway Bar kit w/ leaf spring 7/8 bar	\$269.95	

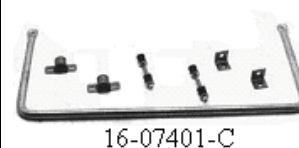
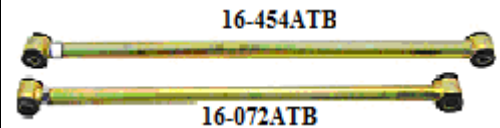

Bill's Truck Shop Limited

Phone (905) 725-3460 / (905) 725-2022 / Fax (905) 404-2302 email: bill@billstruckshop.com

Frame

Group 16

<u>Part No.</u>	INQUIRE for any of the below parts in USED	<u>New</u>	<u>USE D</u>
16-0472	63-72 Rear frame cross brace w/ hdw Replacement style for your missing or damaged	\$89.95	
16-0472-G	63-72 Rear frame cross brace OE style	\$276.00	
16-0472-F	63-72 Frame brace w/ trac bar support coil spring truck	\$276.00	
16-0472-D	63-72 Frame brace-includes shock bkts and upper spring seats coil spring truck	\$229.95	
16-0472-E	63-72 Center frame brace w/ upper shock support & drive shaft support coil spring truck	\$994.95	
16-0472-C	63-72 Transmission support 3 pc kit	\$279.95	
16-0472-B	63-72 Suspension-engine crossmember w/ 1/2 ton up control arm supports	\$3382.00	
16-0472-A	63-72 Front frame brace	\$226.00	
16-0472	63-72 Rear frame cross brace w/ hdw Replacement style for your missing or damaged	\$89.95	

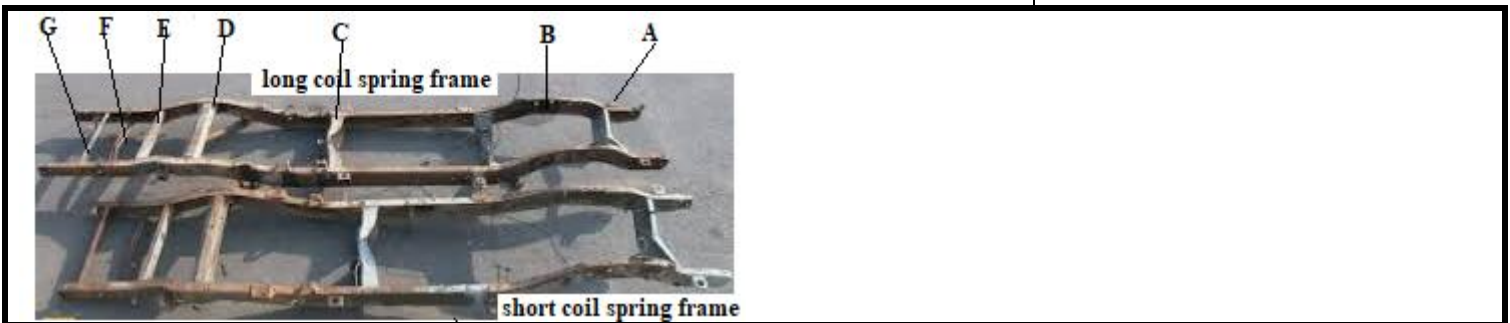
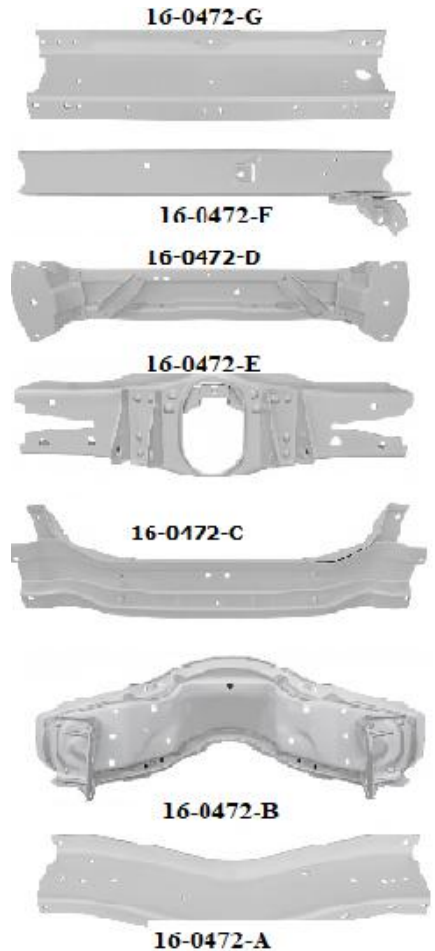
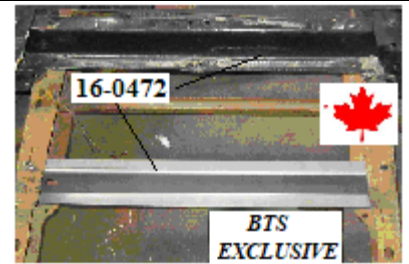

Rear C&K 10/20

Group 16

<u>Part No.</u>		<u>New</u>	<u>Used</u>
16-0510-S	63-72 Rear coil upper spring frame seat w/ hdw	\$39.95	
16-0511	60-72 Rear Coil Spring Retainer upper & lower each	\$14.95	\$10.00

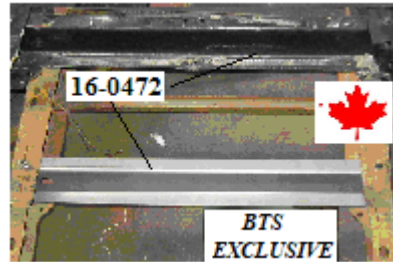
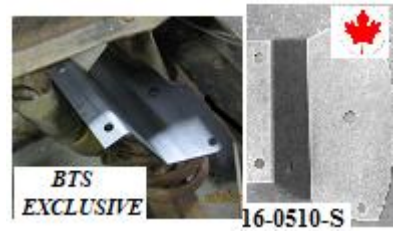

16-0472	63-72 Rear frame cross brace w/ hdw	\$89.95	
---------	-------------------------------------	---------	--

Bill's Truck Shop Limited

Phone (905) 725-3460 / (905) 725-2022 / Fax (905) 404-2302 email: bill@billstruckshop.com

Rear End & Suspension C&K 10/20

Group 16

<u>Part No.</u>		<u>New</u>	
39-0211	47-70 Leaf Spring Center Bolt	each	\$5.95
15-0590	60-87 Shock Bolt w/ hdw		\$9.50
15-0470	60-87 Shock Support Bolt-front upper-each		\$7.50
15-0471	60-87 Shock Bolt -1/2 x 2 1/2 w/ lock washer & nut-each		\$2.00
	When ordering blocks (aluminum) only-check length of u-bolt thread available		
16-0CP4-1	60-72 Rear Lowering Block kit 1" w/ u-bolts		\$119.95
16-0CP4-2	60-72 Rear Lowering Block kit- 2 "w/ u-bolts		\$119.95
16-0CP4-3	60-72 Rear Lowering Block kit 3" w/bolts		\$129.95
16-0228	60-72 Rear Arm to Axle U-Bolt w/ nuts- 10/20	C- each	\$34.95
39-315-FU	Shock bracket-want to relocate the rear shock on 60-61 truck-this bracket bolts to frame		\$29.95
16-4094	60-62 Rear Shock w/ stock suspension-must reuse original steel sleeves (7/16 bolt)14" to 24"		\$69.95
16-0008	63-72 Rear Shock w/ stock height suspension w/ coils each		\$59.95
16-0008	63-72 Rear Gas Shock w/ 2 to 4 " drop-coil or leaf springs-each		\$59.95
15-0039	63-72 Rear Shock- when lowered more then 5" 14" long—10 short--- see note & include #15-0590		\$69.95
16-0372-SRK	63-72 Rear Shock Relocator kit-used when rear suspension is lowered more then 3 "-correct shock angle-w/ coil spring only-requires 2 x # 15-0590 shock bolt @ lower		\$124.95
16-0827-B	64-72 Auxiliary Spring Bumper each		\$9.00
16-0372SK	63-72 Leaf Spring Shackle kit 2 " drop w/ polyurethane bush fits 2 1/4" leaf springs	pair	\$125.00



Bill's Truck Shop Limited

Phone (905) 725-3460 / (905) 725-2022 / Fax (905) 404-2302 email: bill@billstruckshop.com

Rear End & Suspension C&K 10/20

Group 16

<u>Part No.</u>		<u>New</u>
16-0R1559-TV	63-72 Rear Axle Bearing kit to correct worn axle-outer C-10	\$80.50
16-0559	63-72 Rear Axle Bearing -outer w/o Dana rear end ½ ton	\$28.95
16-0560	63-81 ½ ton & 67-81 ¾ ton w /8.875 ring gear Inner axle bearing w/ race each	\$26.95
16-4449	63-64 Axle seal ½ ton w/ HO33 or HO35 rear end 2.55 OD—1.61 ID OE GM # 3819584	\$48.50
41-0695	38-62 Rear Axle Seal ½ ton each	\$25.95
16-0190	64-81 Pinion Seal C 10 -GM 8.875 (Truck) 12 Bolt	\$9.95
16-0044	Rear axle seal----- 1965-79 with semi floating axle, 1980-91 with 8.5" ring gear, and 1980-81 with 8.875" ring gear	\$6.95
41-081B	47-72 47-72 Rear Axle Seal w/o Dana rear axle ¾ ton w/ out Dana rear axle-dana rear axle cover has straight sides-other axle has round cover	\$24.95
Sleeve-rear pinion crush		
41-0151	55-66 ½ ton w/ out posit	\$24.95
41-0152	66-81 ½ ton w/ 8:75 rear end	\$16.50
Rear End Gear Kit raise your top speed		
41-0338	1955-62 3.38 to 1 ratio ring and pinion, ½ ton- we suggest you add rebuild kit # 41-0055-K	Inquire
41-0055-K	55-63 Rear Axle Rebuild kit	\$299.95
Rear Axle Vent		
16-0270	47-72 Rear End vent w/ cover	\$2.50
16-0271	47-63 metal screw in	\$24.95
16-0270-K	63-87 rear axle vent w/ hose	\$11.95
Rear Axle Plug		
41-0225	47-63 Rear axle plug '1" w/ gsk	\$19.95
41-0225-G	47-63 plug gasket (leather)	\$4.50



Bill's Truck Shop Limited

Phone (905) 725-3460 / (905) 725-2022 / Fax (905) 404-2302 email: bill@billstruckshop.com

Rear Axle Cover Gasket

41-0304	37-66 ½ - ¾ 10 bolt rear end 37-63 Chev	
	39-66 GMC ½ ton 1/16 (.063) thick	\$7.95
16-0192	64-81 Gasket-rear cover gasket—8.75 ring gear	\$12.95
	12 bolt C 10	
16-0193	64-72 Gasket-10 bolt cover/GM 8.2 & 8.5 axle	\$12.95
	37-72 ¾ - 1 - 1 ½ H072-52 Eaton w/ 10 bolt	
41-0088	cover	\$21.95

Rear Differential Carrier Gasket

41-0305	47-63 ½ - 10 bolt rear end 37-63 & 37-45 ¾ ton	
	39-70 ½ GMC 1/32 (.031) thick	\$7.95

Pinion Seal

41-0788	55-62 ½ ton w/ common spicer 44 rear end	\$47.95
41-0970	46-65 ¾ - 1/ton- 1 ½ ton- w/ open drive shaft	\$40.95

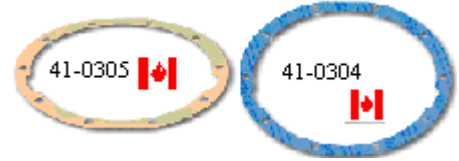

41-0788

Bill's Truck Shop Limited

Phone (905) 725-3460 / (905) 725-2022 / Fax (905) 404-2302 email: bill@billstruckshop.com

Differential ID Chart GM & Dana

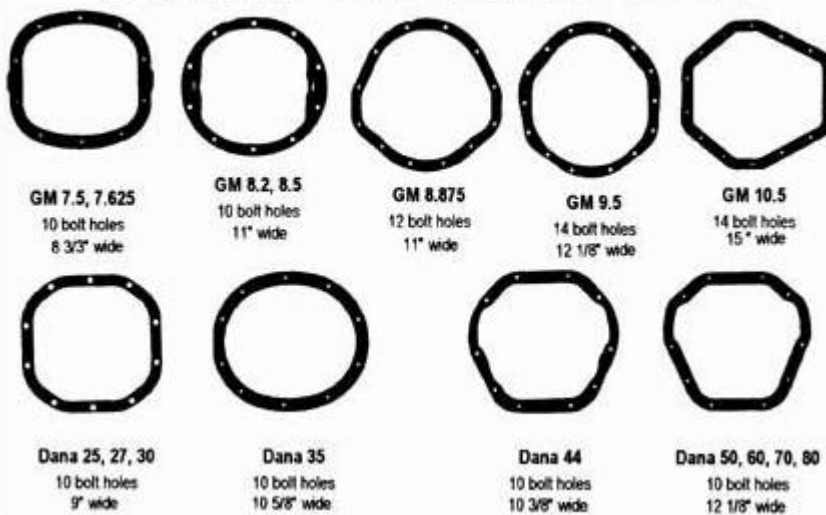

REAR AXLE

Group 17

<u>Part No.</u>		<u>New</u>	<u>Used</u>
16-0072-AS	60-72 Rear Axle Seats-pr-replacement weld on seats for trailing arm	\$69.95	
16-0RPS-4	60-72 Shim—4 deg rear pinion angle shim w/ coil rear springs aluminum pair	\$104.95	
16-4691	63-64 Rear axle-17 spline / 31 " long L & R same		\$150.00
16-0690	65-69 Rear Axles 6 stud ½ ton 30 spline 30 ¾ long each 65-69 Rear Axles Conversion kit to 5 stud-pr/ 30 3/4 in flange out 30 spline requires ½ dia wheel studs # 16-0138-S & 17-0187 drums pair can use on 63-64 w/ updated spider gear set	\$189.95	
16-039RAC-5	63-64 Spider Gear upgrade	\$595.00	
16-00SS	63-64 Spider Gear upgrade	\$225.00	
38-0230-S	51-70 1/2 -63-70 4x4 Wheel Studs-7/16-20x 1 3/8 each	\$3.25	
16-0186-S	64-70 Wheel stud ½ ton 2x2 7/16 -20 x 1 ½ each	\$2.55	
16-0138-S	71-72 Wheel Stud ½ ton 2x 2 ½ x 20 each	\$3.00	
16-5232-S	71-72 Wheel Stud ½ 4x4 each	\$5.95	
38-0230-N	36-70 Wheel nut ¼ - 20 each	\$3.50	
31-0070	36-70 Wheel nut 7/16 x20 w/stainless cap	\$5.50	
17-0187	71-87 Brake Drum-rear C10 11 x 2 each	\$79.95	
16-0717	Spider gear set w/ 30 spline axles 8.875 gear	\$245.95	

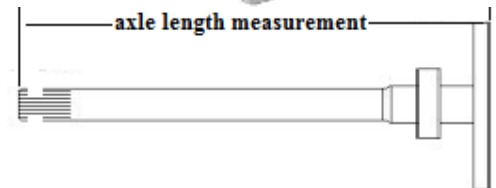

Due to the fluctuation of the Canadian and American dollars call for current prices

Bill's Truck Shop Limited

Phone (905) 725-3460 / (905) 725-2022 / Fax (905) 404-2302 email: bill@billstruckshop.com

REAR AXLE

Group 17

Part No.

New

63-72 Rear Axle C-Notch kit—bolt/weld -supports to allow for more axle clearance on lowered trucks w/ coil springs- **With the upper plate bolted in place, it not only keeps your frame straight and sag free, but it also acts as the template for where you need to cut your frame.**

16-0CNK

\$194.95

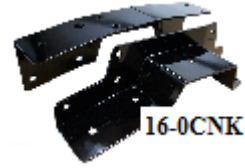

Due to the fluctuation of the Canadian and American dollars call for current prices

Bill's Truck Shop Limited

Phone (905) 725-3460 / (905) 725-2022 / Fax (905) 404-2302 email: bill@billstruckshop.com

Part No.

New

Used

Bill's Truck Shop Limited

Phone (905) 725-3460 / (905) 725-2022 / Fax (905) 404-2302 email: bill@billstruckshop.com



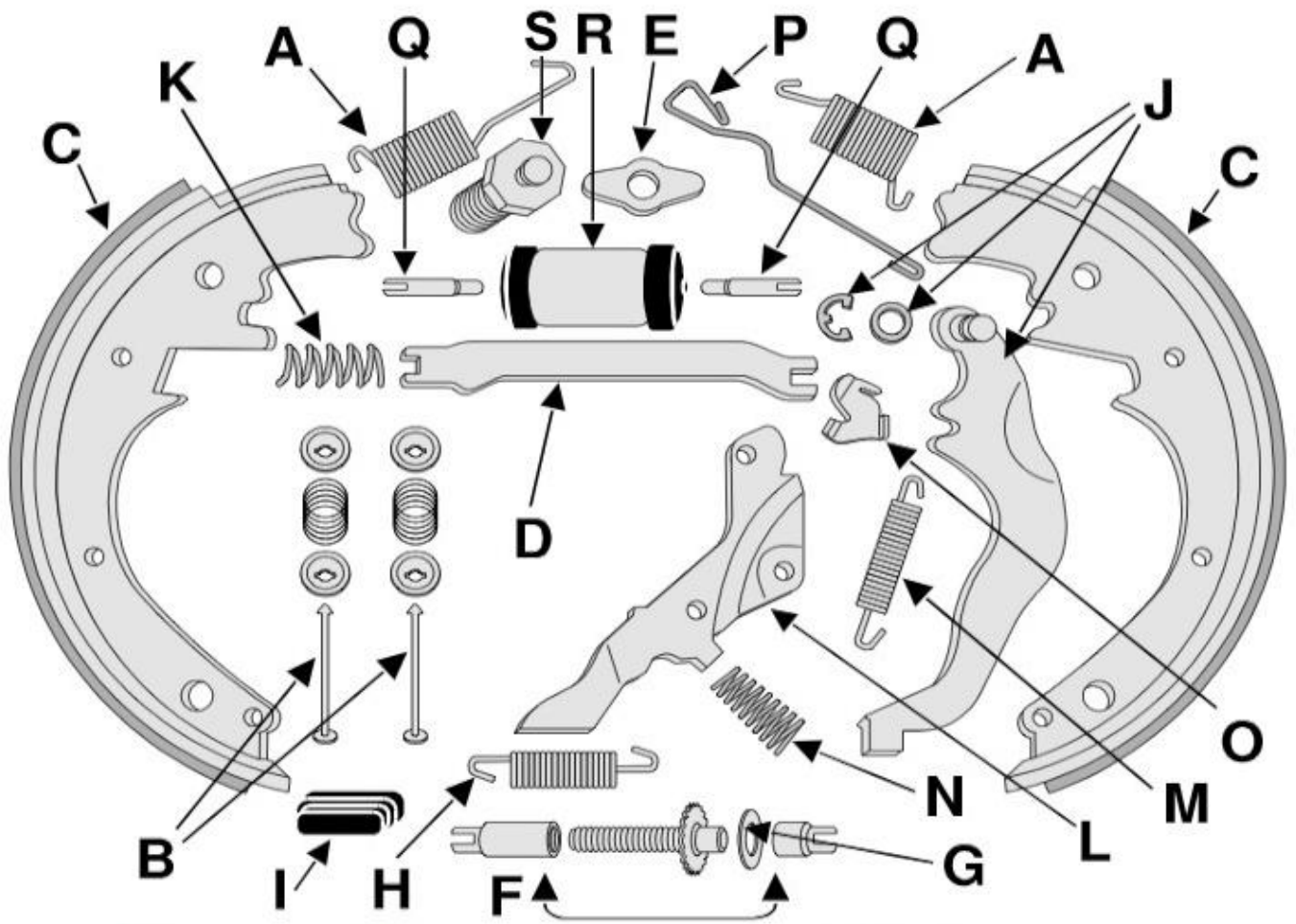

Brakes

Group 17

Part No.		New
38-0206-FR	51-63 Brake Spring kit ½ ton ft @ rear – per axle	\$18.95
17-0017	64-70 Brake Spring Kit-hold down/ return & adjuster C&K 10/20 front	\$22.95
17-0018	64-75 Rear Brake Spring Kit-hold down/ return & adjuster spring C & K 10 w 11 x 2” brakes	\$19.95
17-0027	65-74 Brake spring kit C-K/20-30	\$21.95
17-0418	60-72 Rear Brake Hold Down spring kit w/ 13” shoes C 20 – 30	\$13.50
17-0507	Brake adjuster arm spring each	\$3.95
38-0208	51-62 Brake adjuster screw fits L & R w/ out self adjusting brakes	\$16.95
	Fits 64-75 1/2-3/4 ton rear 2 and 4 wheel drive, 64 1/2 ton 2 wheel drive front, and 65-75 1/2 ton 2 and 4 wheel drive front.can use to upgrade to self adjusting brakes from 55-63	
17-0508	64-75 Brake Adjuster kit w/ 11 brakes L side	\$29.95
17-0509	64-75 Brake Adjuster kit w/ 11 brakes R side	\$29.95
17-0444	60-91 Park brake arm retainer clip w/ tension washer 2 pair /both sides	\$3.00
17-0444-SK	64-91 Stud- park brake arm to shoe 2 pins w/ hdw	\$9.95
17-0701	64-91 Park brake cable arm-left ½ ton w/ 11” brakes	\$34.95
17-0702	64-91 Park brake cable arm-right ½ ton w/ 11 brakes	\$34.95
37-0745	51-91 Strut-park brake 1/2-ton approx 7 ½ long w/ 11 brakes	\$11.95
37-0744	51-87 Park Brake Bar Spring @ cross bar	\$2.50
	SELF ADJUSTING BRAKES-self adjusting brakes can be applied to any 1952-66 chev ½ brakes-add 17-0508 (right) and 17-0509 (left) for front 7 rear	
37-0202-F	55-63 Brake Shoe Set 11 x 2 front or rear set of 4	\$74.95
37-0202-F/P	55-62 Brake Shoe set 11x 2 -premium riveted lining	Inquire
	60-72 ¾ ton ft & rear & ½ 67-70 Suburban/panel front-Brake shoe set	
17-0227	11 5/32 x 2 ¾---premium brand-bonded	\$98.00
37-0330	53-59 front & rear-64-70 rear ¾ ton Brake shoe set- 12 x 2	\$79.95
17-0280	64-70 Front 64-76 Rear brake shoes 11”x 2” C&K 10 set	\$59.95
17-0280-P	64-70 Front 64-76 Rear brake shoes 11” x 2” premium brand riveted linings	\$99.95
17-0248R	60-72 Shoes 11 5/32 x 2- ¾ C 20 front or rear lining are riveted on	\$89.95
17-0248B	60-72 Shoes 11 5/32 x 2- ¾ C 20 front or rear lining are bonded on	\$84.95
17-0127	64-72 Rear Brake shoe set 12 x 2 ½ C 20 & 30	\$87.95
17-460R	60-66 Rear Brake Shoe set C 30 13 x 2 ½	\$99.00
37-0050	51-72 Wheel Cylinder Push Rod each	\$6.95
37-0051	51-91 Brake Shoe Guide Plate ½ & ¾ each	\$9.95

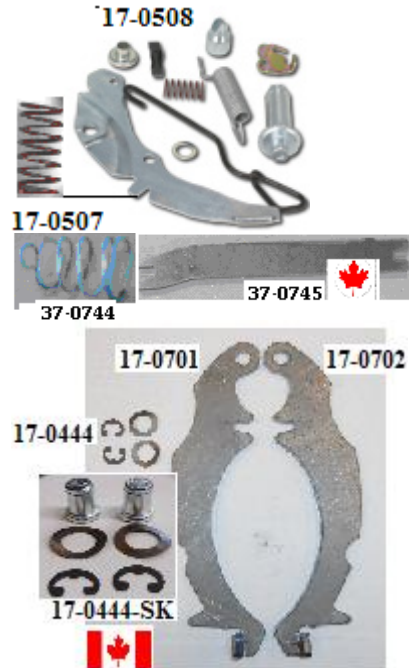

Bill's Truck Shop Limited

Phone (905) 725-3460 / (905) 725-2022 / Fax (905) 404-2302 email: bill@billstruckshop.com

Brakes

Group 17

<u>Part No.</u>					<u>New</u>
37-0203-FL	64-69	Wheel Cylinder	K-10	front left	\$49.95
37-0203-FR	64-69	Wheel Cylinder	K-10	front right	\$49.95
17-0036		Wheel cylinder rebuild kit		1 1/8 " dia	\$14.95
17-0046		Wheel cylinder rebuild kit		1 " dia	\$11.50
37-0054		Wheel cylinder rebuild kit		1 1/4 ' dia	\$24.95
37-0038		Wheel cylinder rebuild kit		1 3/8 dia	\$34.95
17-0025	64-70	Wheel Cylinder	C-10	front left	\$29.95
17-0026	64-70	Wheel Cylinder	C -10	front right	\$29.95
37-0303-RL	55-72	Wheel Cylinder	C/K-10	rear left	\$29.95
37-0303-RR	55-72	Wheel Cylinder	C/K10	rear right	\$29.95
17-0086	63-70	Wheel Cylinder-front	C 20- 30	left	\$69.95
17-0087	63-70	Wheel Cylinder-front	C 20- 30	right	\$69.95
17-0040	64-72	Wheel Cylinder-rear w/ coil springs w/o Dana rear end	C 20-25	left	\$52.95
17-0039	64-72	Wheel Cylinder-rear w/ coil springs w/o Dana rear end	C 20-25	right	\$52.95
17-0474	64-72	Wheel cylinder K & C 20 1 1/8 bore left rear w/LEAF SPRING - DANA RA 133" WB			\$76.95
17-0475	64-72	Wheel cylinder K & C 20 1 1/8 bore right rear w/LEAF SPRING - DANA RA 133" WB			\$76.95
17-0402		Bleeder Screw-wheel cylinder	3/8- 3/8- 24	each	\$1.69
17-0402		Bleeder Screw-wheel cylinder	3/8- 3/8- 24	each	\$0.99
17-4932	60-63	Wheel Cylinder	C/10	front left	\$52.95
17-4933	60-63	Wheel Cylinder	C/10	front right	\$52.95
17-4206	60-63	Wheel cylinder	K/10	front left	\$140.00
17-4205	60-63	Wheel cylinder	K/10	front right	\$140.00



17-0025



37-0303-RL



17-0402



17-4932

Bill's Truck Shop Limited

Phone (905) 725-3460 / (905) 725-2022 / Fax (905) 404-2302 email: bill@billstruckshop.com

Park Brake C&K 10/20

Group 16

<u>Part No.</u>		<u>New</u>	<u>Used</u>
17-0410	60-70 Park brake release handle		\$25.00
17-4410-S	60-66 Support-column & park handle		\$25.00
17-0410-P	60-68 Pin-cable lock pin w/ cotter pin	\$1.00	
17-0525-R	60-68 Retainer-park cable -clamp w/ bolt and cable clevis	\$14.95	
10-0504-P	63-72 Park Cable Grommet	\$4.50	
17-4260	60-62 Front Park Cable- C 10-20 short bed	\$59.95	
17-4261	60-62 Front Park Cable - C 10-20 long bed	\$49.95	
17-4260-K	60-62 Pin-rear park cable to pivot support-pr	\$1.95	
17-4234	63-63 Front Park Cable C-10 & 20-115 & 127 wheel base	\$69.95	
17-4296	64-65 Front Park Cable C-10 & 20-long and short wheel base	\$49.95	
17-0449	66-68 Front Park Cable w/ pull brake lever C10&20	\$59.95	
17-0409	66-68 Front park cable w/ pull lever K 10 & 20	Inquire	
17-0450	66-68 Front Park Cable K 10 & 20 special order	\$105.00	
17-0100	66-80 Intermediate Cable-universal w/ hdw—see long or short cable & add 17-0339—cable lock stop	\$32.95	
17-0596	66-72 Intermediate Cable w/o 400 trans w/ 127 wheel base 118 1/2 " long	\$21.95	
17-0443	66-72 Intermediate Cable w/o 400 trans w/ 115" wheel base 95 "long	\$21.95	
17-0700	Rear Cable Universal w/ hardware —great for non stock applications	\$69.95	
17-4263	60-62 Rear Cable C-10 short bed w/ coil rear spring	\$35.95	
17-4264	60-62 Rear Cable C-10 long bed w/ coil rear spring	\$39.95	
17-4262	60-62 Rear Cable w/ Dana rear end w/ coil springs---bolts to backing plate(special order) each	\$116.95	
17-4299-1	Early 63-63 Rear Cable C-10 w/coil rear springs 115 wheel base w/ 7 ' long	\$32.95	
17-4279	Late 63-65 Rear Cable C-10 w/ coil rear springs w// 127 wheel base	\$32.95	
17-4285	Late 63/64-65 Rear Cable C-10 w / coil rear springs w/115 wheel base 6' 8" long	\$32.95	
17-4284	Late 63/64-65 Rear Cable C 20 w/ coil rear springs	\$59.95	
17-0416	66-72 Rear Cable C-10 w/ coil rear spring	\$39.95	
17-4425	64-66 Rear cable K-10-15 4x4-short bed confirm length each	\$95.00	
17-0056	64-72 Rear Cable K 10 (4X4)—replacement casing 33" cable 48"—bolts to backing plate - may require moving frame bkt -each	\$89.95	
17-0112	Universal rear park cable- kit-----Casing length 70" Cable length 93" -----bolts to backing plate //cut to fit	\$64.95	

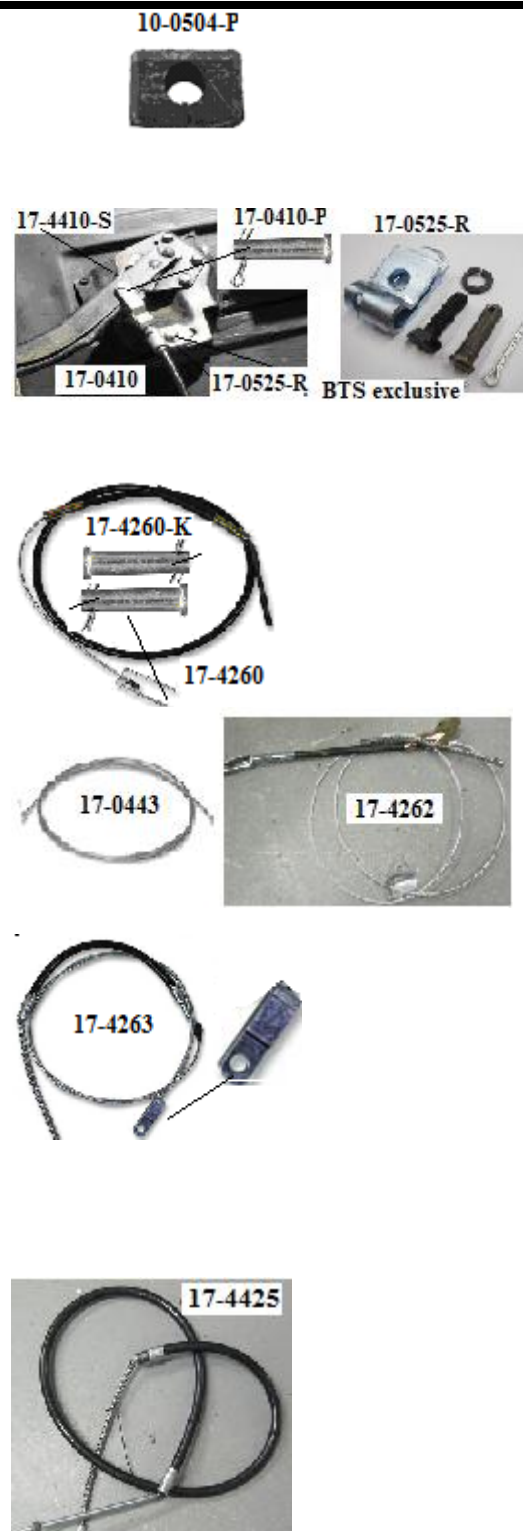

Bill's Truck Shop Limited

Phone (905) 725-3460 / (905) 725-2022 / Fax (905) 404-2302 email: bill@billstruckshop.com

Park Brake C&K 10/20

Group 16

<u>Part No.</u>		<u>New</u>	<u>Used</u>
17-0500A	47-87 Adjustable Cable SHORTENER each	\$9.00	
	See below-- park brake hdw needed when removing the OE pc park cable trans support		
17-0500-C	62-83 Rear Cable Connector each	\$8.95	
17-0805-R	65-72 Equalizer -intermediate cable rod w/ cable guide		\$10.00
17-0805	66-72 Intermediate Cable Equalizer @ front left cable	\$21.95	
17-0500-K	66-72 Brake Cable guide-Connector kit –includes 2 connectors,2 frame guides.1 R ft support rod w/ equalizer 6 pcs	\$42.95	
17-0500-G	66-72 Park Cable Guide –secures cable at frame pair	\$12.95	
17-0445	66-72 Support-park cable on trailing arm each w/hdw can also be used on 60-65 when converting to 66 up park cable design	\$14.95	
37-0320	63-65 Extension-ft park cable w/ hdw	\$19.95	
17-0339	Cable Stop- used when shortening inter cable w/ 1/8 cable	\$4.95	
17-4200	63-65 Support-park cable pivots assembly w/		\$100.00
37-0310-R	55-65 spring w/ rod-locates @ center frame support-- 63-65 1/2-3/4 ton with 3 speed trans. 2 wheel drive.	\$11.95	

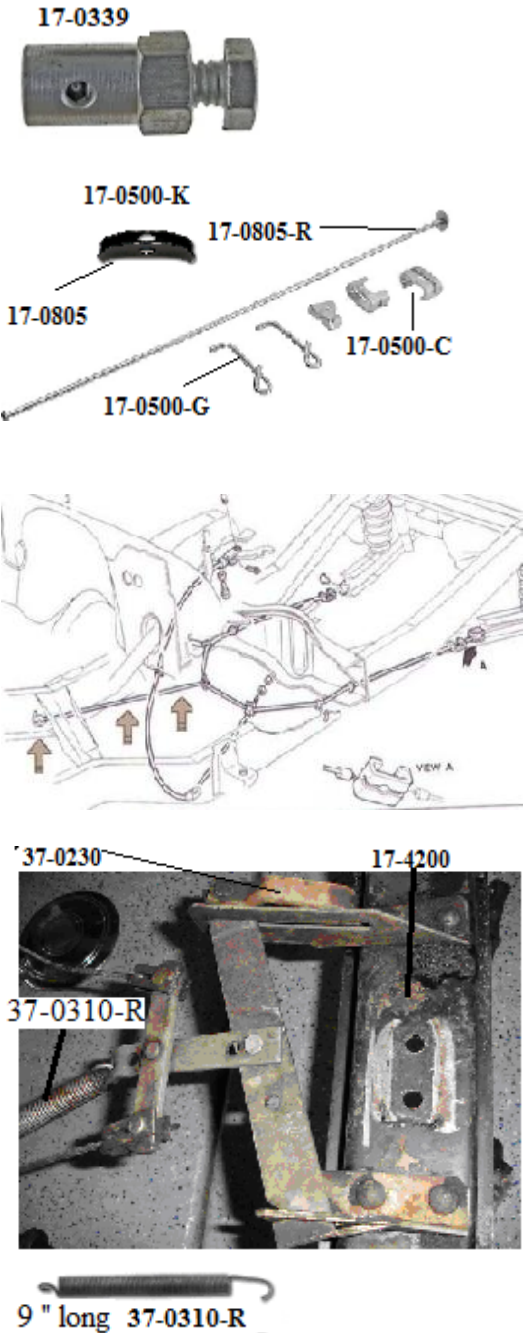

Bill's Truck Shop Limited

Phone (905) 725-3460 / (905) 725-2022 / Fax (905) 404-2302 email: bill@billstruckshop.com

Park Brake C&K 10/20

Group 16

<u>Part No.</u>		<u>New</u>
	63-65 Park Brake cable kit -to replace the OE style (under trans support 3 cable style -see below) w / the 66-72 style-4 cables	
17-0445	66-72 Support-park cable on trailing arm each w/hdw can also be used on 60-65 when converting to 66 up park cable design	\$14.95
17-0102-C	55-87 Retainer-park cable OE wire style pair	\$5.95
17-0519	66-72 Guide-park cable bushing in frame cross member -original OE nylon pair	\$8.95
17-0316	60-87 Retainer-brake line 3/16 pair---gold zinc	\$4.95
17-0125	60-87 Retainer-brake line ¼ pair--- blue coating	\$5.95

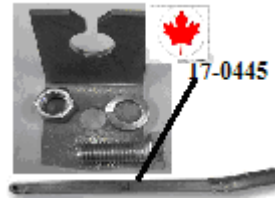

Bill's Truck Shop Limited
 Phone (905) 725-3460 / (905) 725-2022 / Fax (905) 404-2302 email: bill@billstruckshop.com

Brakes

Group 17

<u>Part No.</u>		<u>New</u>	<u>Used</u>
17-4466	60-66 Front Brake Hose K10 4x4 each	\$54.95	
17-0702	Brake Line 3-way Splitter Block ----- 3 x 3/16 used @ ft brake lines- master to R & L brake	\$5.95	
17-4468	60-66 Front Brake Hose C-10/ 20/30 each	\$23.50	
17-4500	61-62 Rear Brake Hose C-10 w/ 115 wheel base -secures to block on axle tube	\$42.95	
17-4501	62-66 Rear brake hose C10 short bed	\$39.95	
17-4503	60-61 Rear Brake Hose C-10- w/ 127 wheel base	\$39.95	
17-4502	62-66 Rear Brake Hose C-10-20 w/ 127 wheel base 20 1/2 " long w / ¼ line	\$39.95	
17-4373	62-66 Rear brake hose K10-20 pkup-surbu	\$59.95	
37-0243	Brake hose gasket 7/16 ID	\$1.25	
37-0795	Brake hose gasket 3/8 ID	\$1.25	
37-0248	38-70 Rear flex hose splitter block- secures to diff housing bracket w/ clip - flex lin 7/16-20 on one side and 3/8-24 on the other 2 sides	\$29.95	
37-08243	Rear brake hos-universal application 25" long w/ splitter block-stud mount		
37-0471	"T" union 3/8-24 3/16-line pipe each	\$6.99	
37-0215-C	Brake Hose Clips each	\$1.65	
37-0217	51-70 Brake Drum front or rear ½ ton 11 x2 C & K each	\$79.95	\$30.00
17-0739	60-70 Brake drum-front 11 5/32x2 3/4-3/4 ton C-P 20	\$89.95	
17-0537	71-87 Disc Brake Rotor 5 stud C10 each	\$94.95	\$35.00
17-04R-6	60-70- Rotors 6 stud - disc brake upgrade-ea	\$149.95	
17-0CORE	Caliper core charge w/o return	\$15.00	
17-0527U	81-87 Brake Caliper w/hdw-R w/ HD spindle	\$89.95	
17-0526U	81-87 Brake Caliper w/hdw-L w/HD spindle	\$89.95	
17-0002	71-87 Brake Caliper pin w/ pad clip-per side		
17-0MD52	71-87 Semi Met Disc Pad set	\$39.95	
17-0408	71-87 Retainer-brake pad each	\$2.50	
17-0800-DC	71-87 Dust Shields for front rotor C10 pair	\$99.95	
17-0800-DC20	71-87 Dust Shields for front rotors C20 pair	NLA	\$150.00
17-4RBK-6	63-66 Rear Disc Brake kit w/ 6 stud rotors- includes rotors,loaded calipers,rear brake lines , hoses & cables w/ mounting hdw 6 lug app. have 7/16 studs	Inquire	
17-0608L-K	Rotors-6 stud upgrade to slotted & cross drilled- consists of a pair that are for LEFT & RIGHT price apply to above kit upgrade only	Inquire	

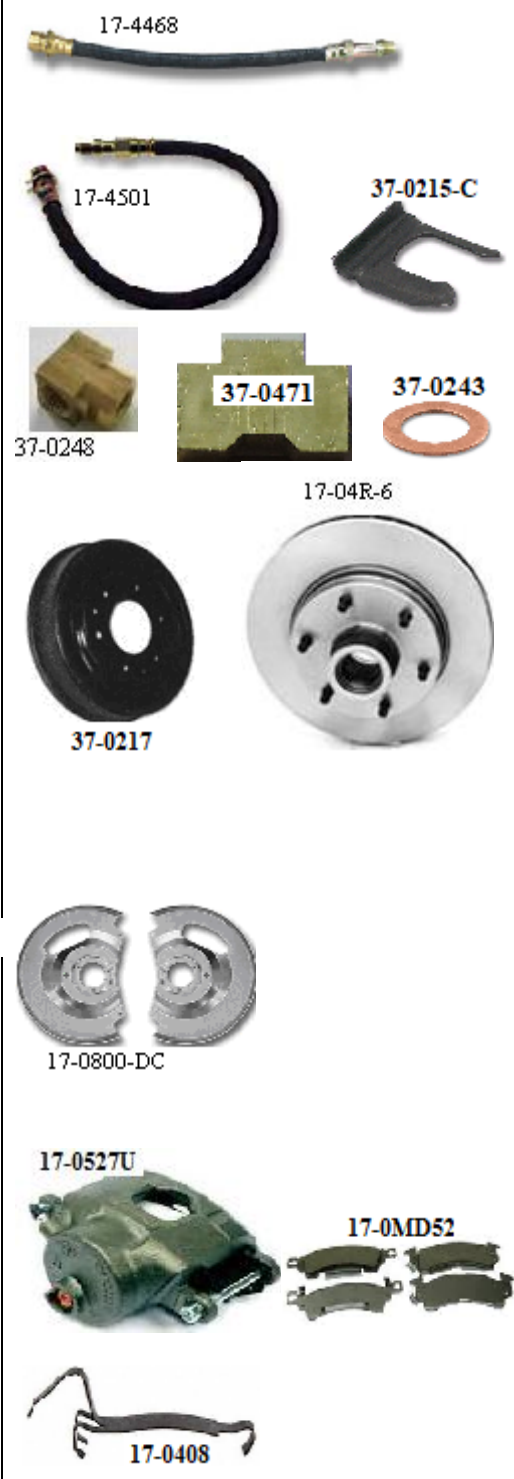

Bill's Truck Shop Limited

Phone (905) 725-3460 / (905) 725-2022 / Fax (905) 404-2302 email: bill@billstruckshop.com

17-0PVKS-2	Brake Proportioning Valve -disc/drum w/ lines-when converting to disc Brass	\$149.95
17-0PVKS-4	Brake Proportioning Valve -disc/disc w/ lines-when converting to disc front and rear Brass	\$149.95
17-0PVKS-A4	Brake Proportioning Valve -disc/disc & or disc/drum— Aluminum	\$159.95
17-0PV-S	60-72 Prop valve line set ft fitting- 1/2 -20 & rear 7/16 -24 (left -outerside on master-top on prop) pr	\$14.95
17-0PVK-H	Harness-prop valve switch	\$19.95
17-0PV	60-70 Distribution valve w/ light switch ---w/ drum-drum dual master	\$104.95
17-04SRB-DP	Power Booster Pins 2 3/8 " long	\$6.00
17-04SRB-SP	Power Booster Pins 4 " long	\$6.00
17-0BV-B	Brake Booster Check Valve	\$15.95
17-0BV-G	Brake Booster Check Valve Grommet	\$7.95
17-0VP-1	Intake Vacuum Port 1 port hose fitting - 3/8 intake hole- for power brakes	\$29.95
17-0VP-2	Intake Vacuum Port 2 port T fitting - 3/8 intake hole- for power brakes & 1/4 auto trans modulator line	\$29.95
17-0VP-3	Intake Vacuum Port 3 port fitting - 3/8 intake hole- for power brakes-auto trans & AC	Inquire
36-0PCH	Hose-booster vac w/clamps-OE style 3/8 -35 " long w/ curved end	\$24.95
17-0HK-R	60-72 Disc Brake Hose kit- rubber w/ 7/16 banjo bolts & clips-	\$55.00
17-6712	Original drum brake flex hoses mount behind the up control arm .79-80 flex hose can be used when converting to disc brakes- secures in hole in frame in front of upper control arm-has bracket to secure hose to upper control arm 79-80 Brake Hose right front each----- use banjo bolt 17-0699	\$39.95
17-6713	79-80 Brake Hose left front each----- use banjo bolt 17-0699	\$39.95
37-0766	73-87 Nut-secures flex hose to frame each	\$0.80
17-0699	Banjo Bolt 10x1.5 - 1 3/8 each	\$5.95
17-0700-B	Banjo Bolt 10x1.5 - 1 7/16 each	\$5.50

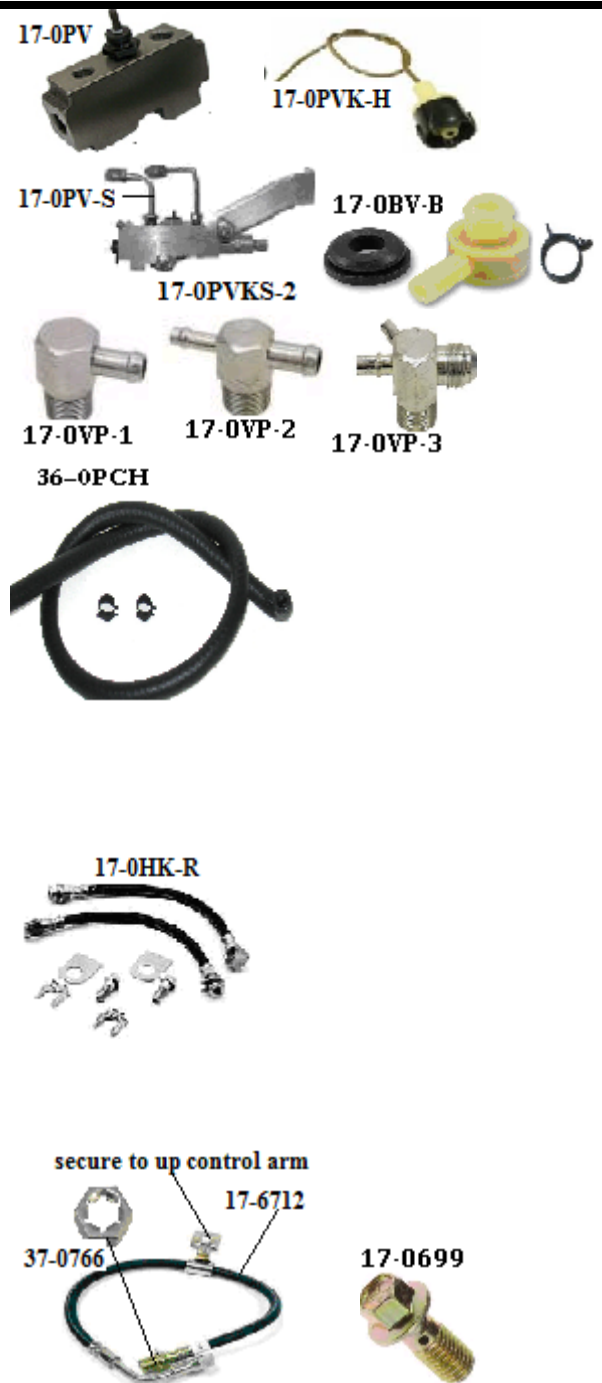

<u>Part No.</u>		<u>New</u>
10-0504-MB	47-72 Master Cylinder Rod Boot w/ manual brakes	\$6.00
17-4404	60-62 Master Cylinder- dual master for brake & clutch	\$179.95
17-4253	60-63 Master Cylinder Rebuild kit-w/dual master-1 1/8 bore-2 req for each side manual brake master are a "deep bore" and power brake master cylinders are "shallow bore"	\$36.80
17-4254	64-66 Master Cylinder- round style, single reservoir 1 " bore	\$99.00
17-0505	67-70 Master Cylinder w/ drum brakes 1 " bore C10 w/ drum brakes -see next page for brake line fittings confirm your pipe size	\$99.95
17-0C100-L	47-72 Master Cylinder Manual / Power / Disc / Drum -Corvette style -NEW 1" bore- 1/2-20 & 9/16-18 port--w/ 1 1/8" deep bore includes -add spacer for shallow bore	\$89.95
17-5246	67-70 Master cylinder w/ drum brakes 3/4 ton up w/ 1 1/8 bore when upgrading to disc and or dual master cylinder	\$159.95
17-0015	Spacer-master cylinder bore-approx 1 1/2 long	\$4.95
<p>Always confirm master cylinder push rod bore dept -all manual have 1 1/2 deep bore---power booster can have deep (1 1/2-- 3/8) bore</p>		
<p>Brake Fitting-oversize</p>		
37-03025	(blue) 1/4 pipe-9/16 dia-18 threads per inch	\$3.50
37-03026	(gold) 1/4 pipe-1/2 dia-20 threads per inch	\$3.50
37-03023	(green) 3/16 pipe-1/2 dia-20 threads per inch	\$2.00
37-03024	(olive) 3/16 pipe 9/16-18 threads per inch	\$3.50



Bill's Truck Shop Limited

Phone (905) 725-3460 / (905) 725-2022 / Fax (905) 404-2302 email: bill@billstruckshop.com

<u>Part No.</u>		<u>New</u>
15-0193	41-87 Spindle Nut / washer & cotter pin ½ ton	\$8.95
17-0977	47-87 Spindle Cap 2x3/32 ID each	\$9.95
17-0977-K	64-87 Spindle Dust Cap w/ nut, washer, cotter pin 2 3/32 large size - 2 sides	\$29.95
17-0978	71-87 Spindle Dust Cap 1 25/32 each	\$3.50
17-0978-K	71-87 Spindle Dust Cap kit w/ nut, washer, cotter pin 1 25/32 small size - 2 sides	\$19.95
17-0B48	60-62 Wheel Bearing -inner ¾ ton each	\$98.95
38-0325-O	38-61 Outer wheel bearing- ½ ton ball type	\$79.95
17-0965	60-62 Grease Seal ¾ ton each	\$22.95
17-0077	60-66 Grease seal inner K 20 4x4 each	\$21.95
15-0757	62-70 Ft Grease Seal-each ½ each	\$24.95
17-0771	63-91 Front Hub Seal ¾ & 1 ton each	\$11.50
17-0898	60-72 Grease seal—4x4 ½ w drum or disc brakes each	\$13.50
17-0BR2	62-70 Wheel Bearing-outer each	\$12.95
17-0BR3	71-80 Wheel Bearing-outer	\$19.95
17-0BR5	62-98 Wheel Bearing-inner each	\$23.95
17-0984	71-91 Grease Seal w/ disc brakes each	\$5.50



Bill's Truck Shop Limited

Phone (905) 725-3460 / (905) 725-2022 / Fax (905) 404-2302 email: bill@billstruckshop.com

Brakes

Group 17

<u>Part No.</u>		<u>New</u>
17-4062-DS	60-62 Brake Booster kit- w/ Standard Trans w/ mount bracket, master cylinder, disc-drum prop valve and hardware-includes hydraulic clutch master cylinder	Inquire
17-4BB-DD9-C	63-66 Brake Booster kit- w/ mount bracket, disc-drum prop valve master cyl and hardware w/ aut trans w/ stainless steel booster & chrome master-prop valve	Inquire
17-4BB-D8	63-66 Brake Booster kit- w/ mount bracket, master cyl for drum-drum application and hardware	Inquire
17-4BB-DD9	63-66 Brake Booster kit- w/ mount bracket, 1" master cyl & prop valve for disc-drum application and hardware -single 9" dia booster	\$499.95
17-46366-BB	63-66 Power Brake Booster w/ bkt only booster	\$269.95
17-4BB-DD9-60	60-62 Brake Booster kit w/ mount bracket, disc-drum prop valve master cyl and hardware w/ aut trans	\$445.95
17-0SRB	Universal Brake Booster-7' single diaphragm	\$113.00
7-0451-R	63-72 Clip- pin retainer-brake push rod	\$7.95
7-0452	63-72 Pin-brake rod pin w/ tension washer & cotter pin	\$2.00
	60-62 Disc Brake w/ stock spindle kit-uses original ball joints, tie rods-includes-dust shields, seals bearings, caps, loaded calipers, brake hoses,6 stud rotors	Inquire
	60-62 Disc Brake w/ 2 1/2 drop spindle kit-uses original ball joints, tie rods-includes-dust shields, seals bearings, caps, loaded calipers, brake hoses,6 stud rotors	Inquire
	63-70 Disc Brake w/ 2.5 drop spindle kit-uses original ball joints, tie rods-includes-dust shields, seals bearings, caps, loaded calipers, brake hoses,6 stud rotors ***	Inquire



Bill's Truck Shop Limited

Phone (905) 725-3460 / (905) 725-2022 / Fax (905) 404-2302 email: bill@billstruckshop.com

<u>Part No.</u>	<u>FAN SHROUDS</u>	<u>New</u>
18-410	63-66 Fan Shroud 8 cyl w/ out AC C-10&20 w/ short neck water pump & engine in ft frame mount holes	\$219.95
10-417-K	63-66 Fan Shroud Supports-2 sides & 1 upper-replacement style kit	\$75.00
10-417-SK	63-66 Screw kit- fan shroud side supports	\$9.95
18-410-SK	63-66 Fan Shroud Screw kit 6 pcs	\$3.95
18-4FS-60-1	60-62 Fan shroud-aluminum w/ single 16" fan opening	\$139.95
18-4FS-1	63-66 Fan shroud -aluminum w/ single 16 "fan opening 24 1/2 wide/17" high/1 1/2 deep made in Canada	\$119.95
SEE PAGE 149 FOR ELECTRIC FANS		
RADIATORS @ Hoses		
6 cyl rads sits down in lower ft cross member & 8 cyl rads sit on top of ft lower cross member		
18-420-0A	60-62 Radiator-2 row w/ auto trans cooler – ALUMINUM radiators are high efficiency two core with 1/2" cores for maximum cooling. Core size is 19 1/4" x 22 3/4". Inlet is 1 1/2". Outlet is 1 3/4"—welded construction secures to rad support	inquire
18-420-0A-A	60-62 Radiator- 3 row w/ auto trans cooler – ALUMINUM radiators are high efficiency two core with 1/2" cores for maximum cooling. Core size is 19 1/4" x 22 3/4". Inlet is 1 1/2". Outlet is 1 3/4"—welded construction secures to rad support	\$424.95
18-420-0A-LS	60-62 Radiator-3 row aluminum w/ auto cooler- Inlet: 1 1/2"w/ LS engine Outlet: 1 3/4 " pass side steam port up pass Same dia spec 18-420-0A	Coming
18-420-3A-A	63-66 Radiator-w/ auto trans cooler – ALUMINUM radiators are high efficiency 3 core for maximum cooling. Core size is 17 1/2" x 25 1/4". Inlet is 1 1/2". Outlet is 1 3/4"—welded construction overall dia 23 3/8 x 25 1/2 sits on rad mounts above frame- because of the square aluminum tanks –the rubber pads require trimming	\$424.95
18-420-3A-LS	63-66 Radiator-3 row aluminum w/ auto cooler- Inlet: 1.25" pass side-top w/ LS engine Outlet: 1.5" pass side steam port up pass Same dia spec 18-420-3A-A	\$449.95
18-420-3S	63-66 Radiator heavy duty 3 row 8 cyl STANDARD-core size 17 3/8 x 24 3/4 —this rad has top and bottom seats	Inquire
18-420-3A-AGMC	63-66 Radiator GMC 3 row w/original 305 or 350 V 6 ALUMINUM rad w/ trans cooler-core 17.25 tall/25.75 wide 2 " core	\$375.00

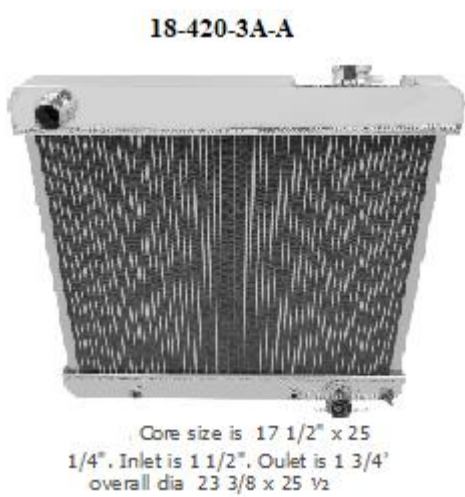
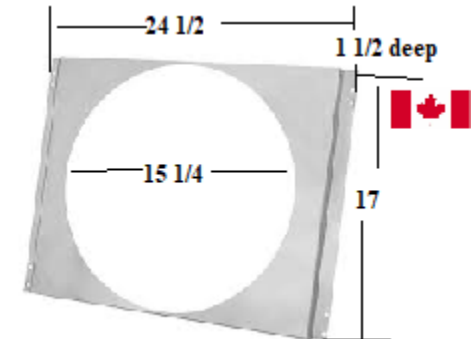

Bill's Truck Shop Limited

Phone (905) 725-3460 / (905) 725-2022 / Fax (905) 404-2302 email: bill@billstruckshop.com

COOLING

Group 18

<u>Part No.</u>		<u>New</u>
	Install hdw when using Aluminum rads	
10-416-R-A	63-66 Retainer-lower rad @ front support pair w/ hdw and pads Use when installing NEW Aluminum rads	\$59.95
10-416-R-AKIT	63-66 Retainer kit- UP & LOW w/ hdw & pads—use when installing the wider Aluminum square tank rads ---install rad next to rad support	\$159.95
10-416-UR-K	63-66 Upper rad retainer kit w/6 or 8 cyl- 3" from flat to top-Rad height 17" core includes cushions & hdw when installing rad on upper support	\$59.95
10-416-U	63-66 Radiator Pads - upper pair	\$15.95
10-416-L	63-66 Radiator Pads lower 6 & 8 cyl pair 63-66 V8 cyl rad sits on top of the cross support against rad support and 6 cyl sits down lower between frame rails -6 cyl rad retainer is 2 1/8 wide and V8 is 2 3/4 on both up & lower position	\$15.95
10-416-LR	63-66 Retainer-lower radiator -w/V8 each	\$19.95
10-416-U	63-66 Radiator Pads - upper pair	\$15.95
10-416-L	63-66 Radiator Pads lower pair	\$15.95



6 cyl 2 1/8
V8 2 3/4



10-416-R-AKIT



10-416-UR-K

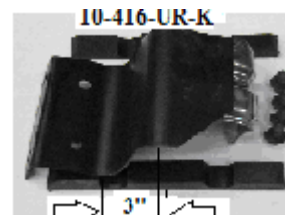

6 cyl 2 1/8
V8 2 3/4

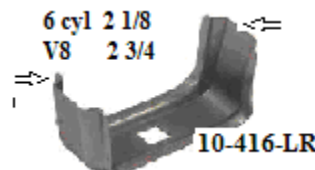

10-416-U



Bill's Truck Shop Limited

Phone (905) 725-3460 / (905) 725-2022 / Fax (905) 404-2302 email: bill@billstruckshop.com

COOLING

Group 18

Part No.

New

HOSES all hose are molded or noted otherwise
Rad Hoses- apply to original engine application w/
 correct short neck water pump, thermostat outlet
 direction and radiator

10-00FH	Hose-rad overflow drain 30" 3/8 thin walled-ribbed hose		\$9.95
41-02HU-B	60-62 Upper Rad Hose 1 1/2 outlet 235 6 cyl		\$30.95
10-0421	60-62 Bypass Hose 6 cyl		\$19.95
10-423-U6	63-66 Upper Rad Hose 6 cyl		\$32.95
10-0424	65-74 Bypass Hose 292 6 cyl		\$21.95
10-420-L6	60-62 Lower rad hose 235 6 cyl		\$36.95
10-425-L6	63-66 Lower Rad Hose 6 cyl		\$39.95
41-3U8	60-62 Upper rad hose V8		\$21.95
18-0424	66-68 Water pump bypass hose 327		\$19.95
10-424-U6	64-66 Upper rad hose 292 vertical -stat outlet		\$32.95
	64-66 Upper rad hose 292 -----vertical stat out		
10-4728	C30-40 etc		\$39.95
10-425-L8	63-66 Lower Rad Hose V8 GM# 3900080 on hose 1 3/4 both ends w/ short neck pump		\$39.95
18-4651	63-66 Upper rad hose- w/ side outlet thermostat housing outlet 1 1/2 x 1 1/2 Id approx. 23" long		\$49.95
	63-66 Upper Rad Hose V8 1 1/2- 1 1/2 dia ID GM # 3826373 w/ angle up stat housing outlet		\$37.95
18-4373	60-66 Upper rad hose-OE style w/pipe and hose connectors @ each end all 60-66 V8 trucks 1 1/2 connector hoses/includes 4 clamps		
18-4373- OE	Confirm rad outlet size 1 1/2 or 1 3/4 - will need to add hose w/ dual inside dia		\$85.95
18-0433	Adapter hose 1 3/4 to 1 1/2 x 6"---cut to fit		\$25.95

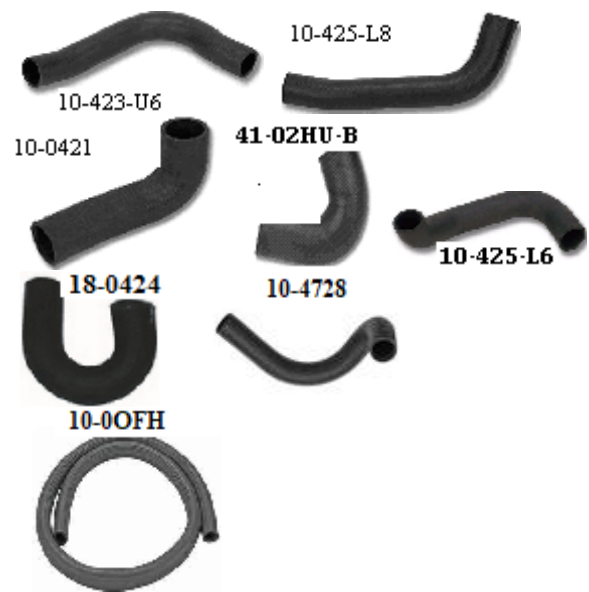

Bill's Truck Shop Limited
 Phone (905) 725-3460 / (905) 725-2022 / Fax (905) 404-2302 email: bill@billstruckshop.com

COOLING

Group 18

<u>Part No.</u>		<u>New</u>
41-0453	58-66 Thermostat housing V8	\$39.95
41-0454	V8 engine/aluminum w/gasket-angle	\$24.95
18-0216	Rad hose clamp 2 1/16 tower style each	\$5.95
18-0256	Rad hose clamp 2 5/16 tower style each	\$5.40
18-0401	Heater Hose 5/8 black approx 3 1/2 ft required	\$3.00
18-0402	Heater Hose 3/4 black approx 3 1/2 ft required	\$3.00
18-0055	Heater Hose Support Clamp on inner fender	\$10.95
22-0205-1	Retainer-heater & AC hose retainer	\$5.00
18-0316	Heater hose clamp 1 3/16 tower style each	\$4.25
18-0116	Heater hose clamp 1 1/16 tower style each	\$4.25
18-0453	Thermostat Housing-straight forward-angle V8	\$19.95
41-0254	40-87 Radiator petcock brass	\$8.95
18-0MCR-3	Coolant Recovery Container kit w/ hdw--1 1/2 quart	\$49.95
18-00HA-1	Hose adaptors -adjusts from 1 3/4 to 2"	\$11.95
18-00HA-2	Hose adaptors -adjusts from 1 1/2 to 1 3/4"	\$11.95
22-0209	Water Control Valve Heater hose-manual control water valve -pull to open 5/8 by 5/8 hose dia- can use 55-59 (T) throttle cable to operate	\$39.95

41-0454



41-0453



18-0216



18-0116



22-0205-1



18-0055



18-0MCR-3



41-0254



18-00HA-2



22-0299



Bill's Truck Shop Limited

Phone (905) 725-3460 / (905) 725-2022 / Fax (905) 404-2302 email: bill@billstruckshop.com

Lights/Lens/Gaskets/Housings

Group 19

<u>Part No.</u>		<u>New</u>	<u>Used</u>
CHEV			
19-401-ALED	60-66 Park lamp w/ LED amber each	\$69.95	
19-401-A	60-66 Park Light Lens -Chev Amber left or right-each	\$11.95	
19-401-C	60-66 Park Light Lens -Chev Clear left or right-each	\$10.95	
19-401-G	60-66 Park Light Lens Gaskets- Chev pair	\$4.95	
19-401-K	60-66 Park Lens Screw kit 8pcs	\$3.00	
19-401-H	60-66 Park Light Housing -Chev left or right-each	\$34.95	\$10.00
19-401-HSK	60-66 Park Light Housing Screw kit -4 screw w/ washers per side	\$2.50	
19-401-60B	60-60 Park Light Bezel fits left & right Chev has vertical bars on ends each	\$75.00	
19-401-61B	61-61 Park Light Bezel fits left or right Chev has 2 horizontal slots on each side each	\$75.00	
19-401-60K	60-61 Screw kit-park light grille-kit-Chev 28 pcs	\$14.95	
19-401-B	62-66 Park Light Bezel - Chev left or right - each	\$24.95	
19-401-62K	62-66 Park Light Bezel hdw kit stainless screws w/ j-nut kit 12 pcs	\$4.95	
GMC			
19-405-60C	60-61 Park Light Lens w/ gasket & rivets clear L or R each NEW ITEM	\$42.95	
19-405-AL	62-66 Park Light Lens w/ rivets amber left	\$34.95	
19-405-AR	62-66 Park Light Lens w/ rivets amber right	\$34.95	
19-405-CL	62-66 Park Light Lens w/ rivets clear left	\$34.95	
19-405-CR	62-66 Park Light Lens w/ rivets clear right	\$34.95	
19-405-G	62-66 Park Light Lens gaskets-pr	\$6.95	
19-405-HL	62-66 Park Light Housing left	\$40.00	
19-405-HR	62-66 Park Light Housing right	\$40.00	
17-0567	Fender-signal & parklight (red & amber lens) Roof & top of fender mount/big truck each	\$24.95	

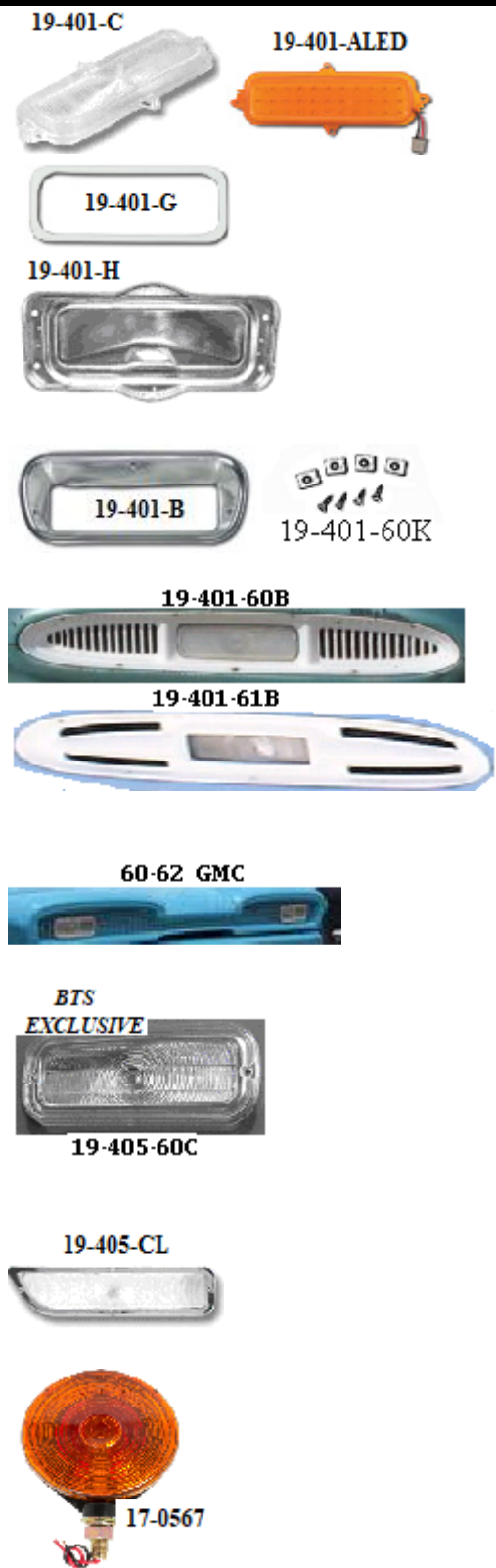

Bill's Truck Shop Limited

Phone (905) 725-3460 / (905) 725-2022 / Fax (905) 404-2302 email: bill@billstruckshop.com

Lights/Lens/Gaskets/Housings

Group 19

<u>Part No.</u>		<u>New</u>	
TAILLIGHTS- / REV LIGHTS -Fleetside			
19-406-LED	60-66 LED Taillight w/ harness	each	\$65.95
19-406-C	60-66 Brake Light Lens w/ Chev Bowtie	each	\$9.95
19-406-GM	60-66 Brake Light Lens w/o bowtie-for GMC	each	\$16.95
19-406-S	60-66 Brake Light Lens Screws -4 stainless steel		\$2.45
19-406-G	60-66 Brake Light Lens Gaskets	pair	4.95
19-406-H	60-66 Brake Light Housing	each	\$38.95
19-406-HG	60-66 Brake Light Housing body Gaskets	pair	\$6.95
19-406-K	60-66 Brake Housing Screw kit	both sides	\$7.95
19-406-B	60-66 Taillight Bezel-fleetside /aluminium	each	\$22.95
19-406-TH	60-66 Harness-fleetside taillight approx. 30"	each	\$8.95
LICENSE PLATE BRACKET w/hardware			
18-0303-F	58-66 Rear Plate Bkt w / light-fleet & stepside-mount to bumper		\$69.95
18-0812	58-66 Plate Bkt bolts- stainless capped bolt @ bumper	pair	\$4.50
18-0303-L	58-66 Plate Light Lens-glass		\$9.95
18-0303-G	58-66 Plate Light Lens- gasket		\$1.50

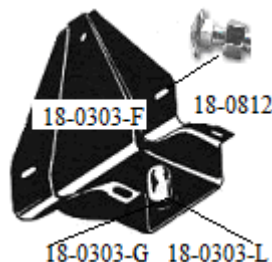
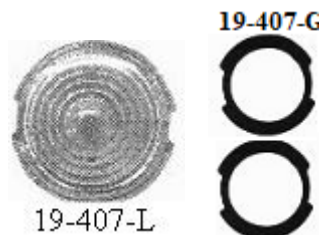

Phone (905) 725-3460 / (905) 725-2022 / Fax (905) 404-2302 email: bill@billstruckshop.com

Lights/Lens/Gaskets/Housings

Group 19

<u>Part No.</u>				<u>New</u>
STEPSIDE				
19-410	60-66	Tail Light Lens	each	\$7.50
19-410-G	60-66	Tail Light gasket	pair	\$4.95
19-410-HB	60-66	Tail Light Assembly black w/harness	each	\$69.95
19-410-HS	60-66	Tail Light Ass stainless steel w/harness	each	\$69.95
19-410-LED	60-66	Tail light Ass w/ LED lights - stainless steel	- each	\$79.95
19-410-L	60-66	Taillight lens LED w/harness	each	\$54.95
17-0510-BL	55-66	Tail Light Bracket black	left	\$10.95
17-0510-BR	55-66	Tail Light Bracket black	right	\$10.95
17-0510-CL	55-66	Tail Light Bracket chrome	left	\$18.95
17-0510-CR	55-66	Tail Light Bracket chrome	right	\$18.95
17-0510-KA	54-72	Taillight Bkt bolt kit-- philips drive w/ washer- stainless steel	8 pc kit	\$7.95
17-0510-KB	54-72	Taillight Bkt bolt kit—7/16 hex head w/ washer - stainless washer	8 pc kit	\$7.95
17-0208		Wire Conduit-stainless steel 18' long	pair	\$19.95
17-0208-G	47-72	Tail Light Harness Grommets	pair	\$2.75

BLUEDOTS

17-0209-P		Plastic Blue Dots-pr		\$8.00
17-0208-B		Taillight socket w/ wires & boot	each	\$8.95



Bill's Truck Shop Limited

Phone (905) 725-3460 / (905) 725-2022 / Fax (905) 404-2302 email: bill@billstruckshop.com

Lights/Lens/Gaskets/Housings

Group 19

<u>Part No.</u>		<u>New</u>	<u>Used</u>
TAIL- / REV LIGHT - Suburban-Panel			
19-415-L	60-66 Taillight lens-panel/surburban	pair	\$82.95
19-415-HL	60-66 Taillight housing-left		Inquire
19-415-HR	60-66 Taillight housing-right		Inquire
19-415-SK	60-66 Screw kit-taillight lens 6 pcs		\$2.50
19-415-G	60-66 Suburban /Panel Tail Light Lens Gaskets	pair	\$7.95
19-0511-G	64-76 Rev Light Lens Gaskets	pair	\$2.50
19-0511-L	60-66 Surbur-Panel-/64-76 Stepside Rev Light Lens	each	\$7.95
19-0511-H	60-66 Surbur-Panel-/64-76 Stepside Rev Light Assembly w black housing	each	\$59.95
19-4511-S	60-66 Reverse Light Housing Seat-rubber		Inquire

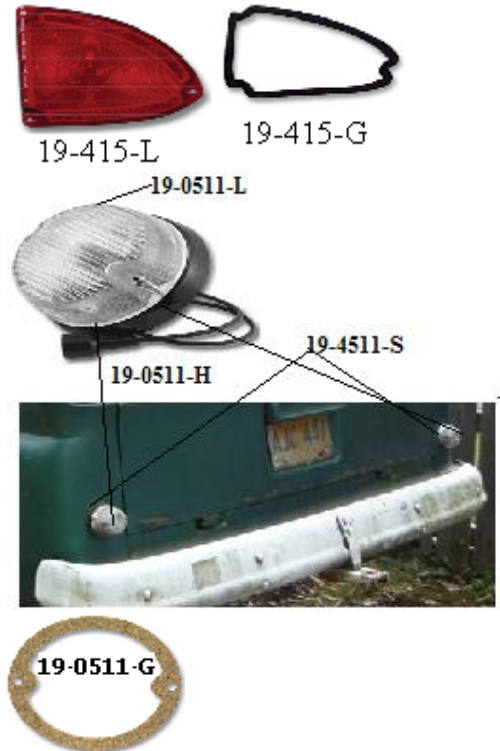

Bill's Truck Shop Limited

Phone (905) 725-3460 / (905) 725-2022 / Fax (905) 404-2302 email: bill@billstruckshop.com

Headlights

Group 19

<u>Part No.</u>		<u>New</u>	<u>Used</u>
HEADLIGHTS			
16-0206-12	55-87 Headlights 12 volt Halogen high/low each	\$22.95	
16-05001H	58-72 Headlights GMC high (inner) Halogen each	\$21.95	
16-05006H	58-72 Headlights GMC high/low (outer) Halogen -- each	\$21.95	
19-0422	62-68-L &R/ 69-72 L Headlight Housing-Chev -- each	\$42.95	\$15.00
19-0HR-3	65-72 GMC Headlight retainer stainless steel 3 screw tabs each	\$12.95	
19-0HR-2	58-64 GMC/58-61 Chev Headlight Retainer-stainless 2 screw tabs each	\$12.95	
12-0HR-1	47-55/63-72 Headlight retainer stainless steel each	\$18.95	
12-0HRS-6	47-87 Headlight Retainer Screw Set per bulb 6 pcs	\$2.95	
16-0432	58-61 Chev & 60-66 GMC Light Adj screw & nut w/ hdw each	\$2.95	
19-0525	62-68 Headlight Adjuster Screw & Nut each	\$2.45	
19-0528-S	62-68 Headlight Adjuster Spring Chev each	\$3.85	\$1.00
19-0529-S	60-61 Chev/60-66 GMC Headlight Adjuster Spring-secures to housing w/ hdw each	\$6.95	
16-0307-1	Headlamp Cup for head light The following "cups" fit 58-61 Chev and 58-66 GMC -includes retainer ring 58-66 Headlight cup outer / left -drivers side w/ ret	\$42.95	
16-0307-2	58-66 Headlight cup inner / left- drivers side w/ ret	\$42.95	
16-0307-3	58-66 Headlight cup outer / right - pass side w/ ret	\$42.95	
16-0307-4	58-66 Headlight cup inner / right - pass side w/ ret	\$42.95	
16-0307-K	Note-cups are stamped w/ "1 for inside and "2 for outside w/L for left and R for right-headlight must sit vertical 58-66 Headlight pot w/ rings—set of 4 (w/ 2 retaining tabs)	\$159.95	



Bill's Truck Shop Limited

Phone (905) 725-3460 / (905) 725-2022 / Fax (905) 404-2302 email: bill@billstruckshop.com

Wiring Harness

Group 19

<u>Part No.</u>		<u>New</u>
FRONT PARK LIGHT HARNESS		
--firewall to hood		
19-4511	60-61 Front Park Lamp Harness	\$84.95
19-4512	62-66 Front Park Lamp Harness	\$95.95
19-0510	60-66 Socket --front park light w/ harness -2 wire-self grounding	\$9.95
Headlamp Repair Socket		
16-0001	Socket w/ stub harness 3 wire each	\$3.95
FRONT HARNESS		
	<ul style="list-style-type: none"> ■ firewall to rad support light plug, gen/alt, volt reg, horn ■ for Chev unless noted 	
19-4225	60-60 Front light harness w/ generator w/gauges	\$129.95
19-4065	60-60 Voltage regulator extension harness to gen	Inquire
19-4224	60-60 Front light harness w/ gen & dash gauges	\$174.95
19-4226	61-62 Front light harness w/ generator	\$89.95
19-4025	62-62 Front light harness w/ alt	\$189.95
19-4228	63-66 Front light harness- Alt w/ warning lights	\$153.95
19-4230	63-66 Front light harness w/factory gauges & alt w/ ext VR-includes pos red wire from bat to horn relay	\$119.95
19-4715-DI	63-66 Front light harness w/factory gauges -- modified for drivers side (left) 1983-85 & earlier internal voltage reg alternator	\$239.95
19-4715-PI	63-66 Front light harness w/factory gauges -- modified for pass side (right) 1983-85 & earlier internal voltage reg alternator	\$239.95
19-4125	63-66 Front light harness w/ warning lights	Inquire
19-4125-DI	63-66 Front light harness w/ warning lights modified for drivers side (left) 1983-85 & earlier internal voltage reg alternator	\$239.95
19-4125-PI	63-66 Front light harness w/ warning lights modified for pass side (right) 1983-85 & earlier internal voltage reg alternator	\$239.95
19-4271	64-66 GMC Front engine harness w/ gen or alt,voltage regulator,horn & horn relay,temp & oil sender , starter , coil w/ dash lights	\$149.95
Harness-converts OE harness to alternator		
19-4560-A	60-62 V8 add to OE gen harness	\$89.95
HEADLAMP HARNESS		
--connects at rad support and plugs to lights		
19-4561	61-61 Chev & 60-66 GMC Front Headlight Harness	\$89.95
19-4562	62-66 Front Headlight Harness	\$89.95



19-4230

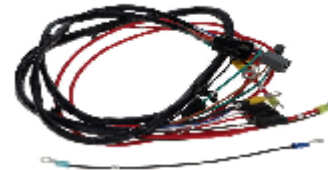

19-4830



19-4710



19-4271

Bill's Truck Shop Limited

Phone (905) 725-3460 / (905) 725-2022 / Fax (905) 404-2302 email: bill@billstruckshop.com

Wiring Harness

Group 19

<u>Part No.</u>		<u>New</u>
ENGINE HARNESS		
	Harness w /lights - light switch has 2 terminal- indicates hot and cold ---switch #19-4625	
19-4625	61-66 Water Temp Switch w/ lights-- 2 pin - 1/2x 14NPT off@103deg F---on@ 243-263 deg F	\$46.95
19-0316	Wire insulator- OE style- black asphalt coated fabric 3/16 ID-----per ft	\$2.50
19-4111	60-61 Engine Harness – 6 cyl	\$129.95
19-4113	60-61 Engine Harness- 8 cyl	\$129.95
19-4119	62-62 Engine harness 6cyl w/ warning lights	\$129.95
19-4305	63-63 Engine harness V8 w/ factory gauges	\$129.95
19-4830	64-66 Engine harness V8 w/ factory gauges w/OE style connections	\$139.95
19-4130	64-66 Engine harness V8 w/ factory gauges w/ replacement style connections	\$99.95
19-4830H	64-66 Engine harness V8 w/ HEI distributor w/ factory gauges	\$159.95
19-4710	63-66 Engine harness V8 w/ warning lights	\$89.95
19-4710H	64-66 Engine harness V8 w/ HEI- warning lights	\$159.95
19-4650	63-66 Engine harness 6cyl w/ warning lights	\$119.95
19-4650H	63-66 Engine harness 6cyl w/ warning lights w/ HEI distributor	\$119.95
19-4124	63-66 Engine Harness-6cyl w/ gauges	\$99.95
19-4110H	63-66 Engine harness 6cyl w/ gauges w/ HEI distributor	\$119.95
19-0001	Harness-HEI distributor-battery & tach-pair w/ 8" extension	\$14.95
Tach Harness		
19-4693	64-66 Tach harness w/ V8 & HEI	\$69.95
Custom Wiring Harness-American Autowire kit		
	New updated wiring harness w/ 18 fuse -21 circuit -includes plugs, switches for original or aftermarket gauges-HEI or point type dist harness- column connectors for stock or updated columns-front, rear & dome light harness-updates for original or AC updates, power windows, seats, stereo, electric fuel pumps etc	
19-4560	60-66 Classic Updated Wiring Harness for Chev trucks inquire for GMC	\$1349.95



19-4625



19-0316



19-4830



19-4710



19-0001

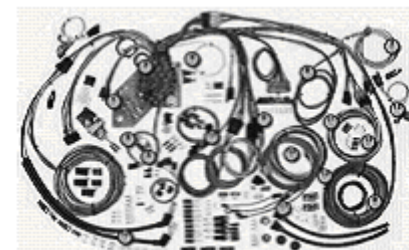

19-4560

Bill's Truck Shop Limited

Phone (905) 725-3460 / (905) 725-2022 / Fax (905) 404-2302 email: bill@billstruckshop.com

<u>Part No.</u>		<u>New</u>
MAIN DASH HARNESS-CHEV		
contains fuse block, connectors for headlight, ignition, dimmer and firewall connectors-does not include instrument cluster harness		
19-4322	60-61 With temp/fuel gauge & gen & oil light & signals	\$479.95
19-4323	62-62 with factory gauges or w/lights	\$479.95
19-4325	63-63 With Warning Lights/auto or std	\$479.95
19-4326	63-63 With Gauges	\$479.95
19-4327	64-65 With Warning Lights	\$479.95
19-4328	64-65 With Gauges	\$479.95
1966 harness includes wiper motor harness		
19-4329	66-66 With Warning Lights/ auto or std	\$479.95
19-4330	66-66 With Gauges	\$479.95
FUSE KIT		
19-4001	60-66 Fuse kit- 2 for each location 2 x 20A---4 x 3A---2 x 10A---4 x 15A	\$10.95
LIGHT BULBS		
18-0HB-12V	47-66 High Beam Indicator Bulb	\$1.20
18-0DB-12V	47-66 Dash bulbs	\$1.50
Wiring Plug w/ grommet @ connectors		
18-0547	universal 8 plug pass through connector kit	\$22.95
Fuses-barrel style		
18-0003	18-0003 3 amp----- 9 /16 long	\$0.99
18-0004	18-0004 4 amp----- 1 ¼ long	\$0.99
18-0005	18-0005 5 amp----- 1 ¼ long	\$0.99
18-0010	18-0010 10 amp----- 1 ¼ long	\$0.99
18-0015	18-0015 15 amp----- 1 ¼ long	\$0.99
18-0020	18-0020 20 amp----- 1 ¼ long	\$0.99
Dash Bulb Socket		
18-0DB-S	USED OE metal socket w/ new harness	\$9.95
18-0DB-SN	New plastic replacement socket w/ ,6" wire	\$5.95
Dash Bulb-wiring-to replace dash bulb wiring when insulation is broken away using your original metal socket		
18-0DB-W	Replacement terminal w/ 8" wiring -connector	\$1.75

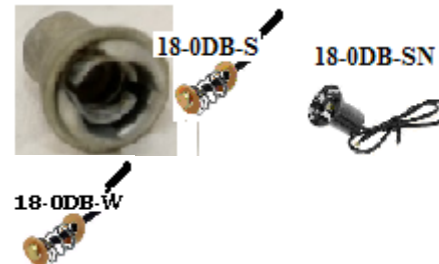
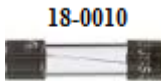

Bill's Truck Shop Limited

Phone (905) 725-3460 / (905) 725-2022 / Fax (905) 404-2302 email: bill@billstruckshop.com

<u>Part No.</u>	<u>INSTRUMENT CLUSTER HARNESS</u>	<u>New</u>
	connects main harness to instrument cluster and gauges-lights	
19-4351	60-61 W/ warning lights	\$149.95
19-4353	62-63 W / warning lights	\$149.95
19-4354	62-63 W / gauges	\$149.95
19-4355	64-66 W / warning lights	\$89.95
19-4356	64-66 W/ gauges	\$89.95
18-0204-F	47-72 Harness Clips on frame @rear cross sill set of 4	\$12.95.
FRONT to REAR		
19-4711	60-61 Front to Rear Harness 115-133 ' wheel base starts at floor beside seat	\$89.95
19-4712	62-66 Front to Rear Harness 115-133 " wheel base-includes rev lead w/ rev light option	\$142.95
TAIL LIGHTS		
19-4716	60-61 Rear Taillight Harness-step or fleetside-w/ square plug connector	\$84.95
19-4717	62-66 Rear Taillight Harnes-fleetside	\$124.95
19-4714	62-66 Rear Taillight Harness-stepside	\$69.95
17-0208-B	Taillight socket w/ wires & boot each	\$8.95
REVERSE LIGHT HARNESS when adding rev lights to truck-original harness may not have the rev harness w/ taillight harn		
19-4930	62-66 Rev Light Harness – rear connection to lights	\$39.95
19-4645	62-66 Rev Light Harness-firewall to rear connect	\$32.95
HEATER & AC		
19-4721	60-63 Heater Harness w/ std heater	\$49.95
19-4718	60-62 Heater Harness w/ dlx 3 spd heater	\$59.95
19-4774	63-63 Heater harness w dlx 3 speed heater	\$59.95
19-4719	64-66 Heater Harness w/std heater	\$39.95
19-4720	64-66 Heater Harness w/ dlx heater w/ light harness	\$49.95
19-4965	65-66 AC Harness-includes blower switch jumper-and power wire from horn relay-requires power wire from starter to horn relay to complete circuit	\$169.00
HEATER LIGHT HARNESS		
19-4730	60-66 Heater Light Harness-from fuse panel to control	
Wiper Motor		
19-4063	61-61 Wiper Motor Harness- 2 speed w/ washer pump	\$26.95
19-4213	62-62 Wiper Motor Harness -2 speed w/ washer pump	\$26.95
19-4175	63-65 Wiper Motor Harness- 2 speed w/ washer pump	\$34.95



19-4712



18-0204-F



19-4714



19-4717



19-4720



19-4175



5-0DLH

Bill's Truck Shop Limited

Phone (905) 725-3460 / (905) 725-2022 / Fax (905) 404-2302 email: bill@billstruckshop.com

Electrical Parts & Harness

Group 19

<u>Part No.</u>		<u>New</u>	<u>Used</u>
ELECTRICAL PARTS			
3-0BS	60-72 Brake Light Switch w/ nuts	\$11.00	
3-0417	60-72 Neutral Safety Switch w/ auto trans	\$15.95	
19-0469	55-72 Sender-water temp w/ gauges 6 or 8 cyl ---1/2 x 14 NPT w/ "T" terminal	\$36.95	
19-0469-A	57-78 Sender-water temp 6 or 8 cyl 1/2 x 14 NPT w/ gauges- correct resistance for a more accurate OE gauge reading w/ "T" terminal	\$48.95	
19-4625	61-66 Sender-water temp w/ lights-- 2 pin - 1/2x 14NPT off@103deg F---on@ 243-263 deg F	\$34.95	
19-0020	60-87 Oil Pressure Switch w/ lights	\$10.95	
19-0VR	63-72 Voltage Regulator 12 volt/neg ground mechanical type 2 unit type	\$89.95	
19-0VR-MK	63-72 Voltage Regulator Mount kit 3 screws w/ cushion nuts OE style	\$12.95	
14-042-H	47-87 High Tone 12 V horn---universal	\$21.95	
14-042-L	47-87 Low Tone 12V horn----universal	\$21.95	
14-0452-LOE	63-87 Horn-low tone-OE style w/ bkts	\$89.95	\$30.00
14-0452-HOE	63-87 Horn-high tone-OE style w/ bkts	\$89.95	\$30.00
18-0309-57	57-62 Horn relay w/ push on pins	\$39.95	
18-409	63-66 Horn Relay-locates @ rad support w/ push on pins @ screw board	\$46.95	
19-0578	60-87 Switch-4 speed trans w/ rev lights	\$33.95	



Bill's Truck Shop Limited
 Phone (905) 725-3460 / (905) 725-2022 / Fax (905) 404-2302 email: bill@billstruckshop.com

Electrical Parts & Harness

Group 19

<u>Part No.</u>		<u>New</u>
	COURTESY LIGHTS/ RADIO/ DOME LIGHT	
	DOME LIGHT	
5-0DLH	60-72 Dome Light Harness	\$9.95
	FUEL TANK GAUGE WIRE	
19-4244	60-66 Fuel Tank Wire-from fuse panel to tank-pickup	\$23.95
19-0352	Retaining clip-secures fuel tank wire to tank @ top seam/secures courtesy lamp wire to dash sold in pairs	\$2.00
	STEERING COLUMN ADAPTOR	
19-4618	63-66 Adapts 67-72 column signal harness to the 63-66 dash harness	\$69.95
	ALTERNATOR CONVERSION KIT	
19-0555	Converts 1963 -1974 External volt reg to newer SI internal volt reg alt	\$32.95
19-0455	63-76 Plug w/ stub harness-alternator w/ external voltage regulator	\$3.95
19-0055	19-0055 12 volt- 55 amp- NEW -requires 1 wire hook up may require turning housing for positive pin	\$159.95
19-0412	Torque Converter Lockup Kit, Pressure Switch, In-line Fuse, GM, 200-4R, 700R4, Kit	\$129.95
	RADIO	
5-0525-RH	61-72 Radio Power Wire	\$24.95
5-0525-SH	64-72 Speaker Harness	\$28.95
15-0HL	Under hood lamp assembly—reproduction GM option	\$69.95



Bill's Truck Shop Limited

Phone (905) 725-3460 / (905) 725-2022 / Fax (905) 404-2302 email: bill@billstruckshop.com

<u>Part No.</u>		<u>New</u>
Wiring Loom		
18-0WL-1	Wire Loom 1/4 fabric per foot	\$1.50
18-0WL-3	Wire Loom 3/8 fabric-per foot	\$1.70
18-0WL-5	Wire Loom 1/2 fabric-per foot	\$1.95
Wiring Retainers		
18-0853	Nylon- harness supports-fit ¼ hole 2 ½ “ long each	\$3.50
18-0514	Nylon- harness supports-fit ¼ hole 1 ½ long each	\$3.25
18-0391	Nylon-harness support snaps into 2 holes pair	\$3.95
41-0GT	47-62 Generator Warning Tag	\$4.95
8-0880	Battery Cable End-replacement clamp style-each	\$3.95
8-0878	Cable adaptors- side post cable to top post battery pair	\$9.95
Battery Cable Cover-top post/slip on		
8-0760-R	red/positive	\$2.95
8-0760-B	black/neg	\$2.95
BATTERY CABLES		
19-0204	Battery Cable –neg 25” long 4 gauge-black w/clamp end	\$23.95
19-0204-S	Battery Cable –neg 25” long 4 gauge-black w/ side terminal	\$28.95
19-0207	Battery Cable-pos 43” long 4 gauge-red w/ clamp end	\$34.95
19-0207-S	Battery Cable-pos 43” long 4 gauge-red w/side terminal	\$39.95
18-0987	Fuse holder-sealed w/ hdw & fuse- note fuse size	\$4.95
Ground Strap-tin coated copper wire		
18-0170-8	8 “ #11 gauge w/ 3/8 eyelets-excellent for grounding body to frame eg cab/ bed etc	\$12.95
37-0315	Insulated clamp style w/ hdw pair	\$3.75
GROUND STRAP KIT		
19-0655-K	67-72 Ground Strap kit ----inner fender ft-R ft cab support- 2 engine rear & 1 bed rear- correct for 67-72 -can be used other vehicles (tinned copper wire)	\$49.95



Bill's Truck Shop Limited

Phone (905) 725-3460 / (905) 725-2022 / Fax (905) 404-2302 email: bill@billstruckshop.com

Bills Truck Shop Sheet Metal

Most panels are E-D-Primer coated and are carefully packaged to protect against damage that may occur during transit. Most parts are individually boxed for damage free shipping.

However, after overseas transport & cross country delivery to you, it is likely there could be a small ding or minor scratch.

These minor blemishes cannot be helped and are considered normal due to the nature of the product. Any physical damage in transit must be reported to delivering carrier at time of delivery.

Test fit all panels prior to paint and installation

Part No.

New

For patch panels see section 27

All reproduction parts are made to be an exact replacement of original, using 19 gauge metal coated in EDP black primer and boxed to prevent shipping damage. Fenders are stamped from new tooling using zinc impregnated 0.90mm thick steel All used parts are from California and vary in condition and priced at the "up to" best condition

RAD SUPPORT

20-401 60-66 Rad Support w / X braces \$289.95

Support to Surround Filler Panels

20-403-L 60-66 Filler Panel-left black \$84.95

20-403-R 60-66 Filler Panel-right black \$84.95

20-403-LC 60-66 Filler Panel-left CHROME \$124.95

20-403-RC 60-66 Filler Panel-right CHROME \$124.95

20-403-HK 60-66 Hdw kit-per side 10 stainless steel philip screws w/ washers \$18.95

20-403-2L 60-66 Filler Panel - trucks w/ flared fenders left Inquire

20-403-2R 60-66 Filler Panel- trucks w/ flared fenders right Inquire

GRILLE SURROUND

Grille supports holes must be redrilled for GMC application in all year surrounds

20-402-1 60-62 Grille Surround Chev & GMC \$624.95

20-402-2 62-62 Grille Surround Chev & GMC NLA

20-402-3 63-63 Grille Surround—DISC—use 1964-66 NLA

20-402-4 64-66 Grille Surround \$624.95

20-402-0G 60-62 Grille Surround GMC

63-66 Grille Surround GMC #20-402-4-64-66

20-402-3G Chev can be used-must drill light support bkt hole

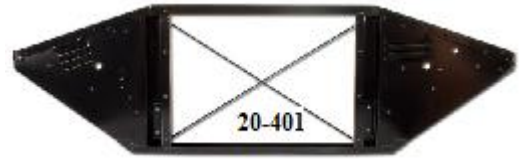

20-402-4

Bill's Truck Shop Limited

Phone (905) 725-3460 / (905) 725-2022 / Fax (905) 404-2302 email: bill@billstruckshop.com

Part No.

New

For patch panels see section 27

All reproduction parts are made to be an exact replacement of original, using 19 gauge metal coated in EDP black primer and boxed to prevent shipping damage. Fenders are stamped from new tooling using zinc impregnated 0.90mm thick steel All used parts are from California and vary in condition and priced at the "up to" best condition

FENDERS

20-405-L	60-66 Front Fender	Chev & GMC	left	\$369.95
20-405-R	60-66 Front Fender	Chev & GMC	right	\$369.95

Bolts not included w/ cab bracket

27-4265-L	60-66 Front Fender to Cab Bracket		left	\$31.95
27-4265-R	60-66 Front Fender to Cab Bracket		right	\$35.85
27-4265-HK	60-66 Bolt kit-fender to cab bracket & bracket to cab		4-pcs per side	\$12.95

27-4163	60-66 Front Fender Rear Lower	15 " H	left	\$44.95
27-4164	60-66 Front Fender Rear Lower	15 " H	right	\$44.95
27-4263	60-66 Front Fender Brace	24' high	left	\$69.95
27-4264	60-66 Front Fender Brace	24' high	right	\$69.95

20-410-L	60-66 Inner Fender		left	\$299.95
20-410-R	60-66 Inner Fender		right	\$299.95
10-414-BK	60-66 Inner Fender bolt w/ washer & sleeve		pr	\$12.95

20-410-C	60-66 Inner Fender Cover		left @ steering column	
----------	--------------------------	--	------------------------	--



20-405-R



27-4163



27-4263



20-410-L

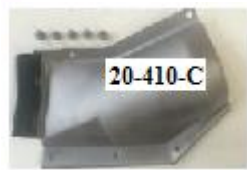

20-410-C

Bill's Truck Shop Limited

Phone (905) 725-3460 / (905) 725-2022 / Fax (905) 404-2302 email: bill@billstruckshop.com

<u>Part No.</u>			<u>New</u>	<u>Used</u>
HOODS / HINGES / COWL				
20-414-60	60-61 Hood	Chev		Inquire
20-414-62	62-66 Hood (will also fit 60-61)	Chev	\$2395.95	Inquire
20-414-60G	60-61 Hood	GMC		Inquire
20-414-62G	62-66 Hood	GMC		Inquire
20-414-B	60-66 Bolts-hood hinge -8 pcs w/floating washer		\$29.95	
20-415-L	60-66 Hood Hinge	left	\$99.95	\$40.00
20-415-R	60-66 Hood Hinge	right	\$99.95	\$40.00
20-415-S	60-66 Hood Hinge Spring		\$32.95	
20-414-61R	60-61 Hood Release	Chev & GMC		\$75.00
20-414-62R	62-66 Hood Release	Chev -64-66 GMC	\$119.95	
2-0502-S	60-82 Spring @ secondary hood vertical latch		\$3.95	
20-414-L	62-66 Hood striker/latch support w/ lock pin		\$64.95	\$40.00

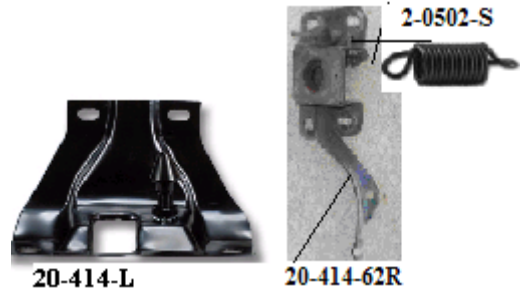

Bill's Truck Shop Limited

Phone (905) 725-3460 / (905) 725-2022 / Fax (905) 404-2302 email: bill@billstruckshop.com

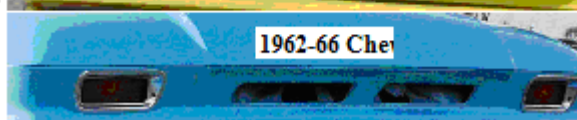
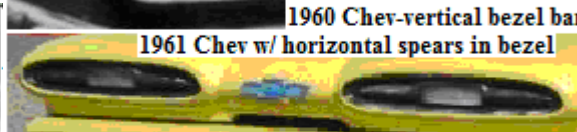

<u>Part No.</u>		<u>New</u>	<u>Used</u>
20-416	60-66 Cowl Screen	\$359.00	\$175.00
20-416-BS	60-66 Cowl screen w/o grille holes-SMOOTH	\$359.00	
10-410-S	60-66 Cowl Screen Screw - 7 black screws	\$3.15	
20-420-L	60-66 Outer Cowl panel left	\$209.95	\$100.00
20-420-R	60-66 Outer Cowl Panel right	\$209.95	\$100.00



BATTERY TRAY includes bolts

20-425-T	60-66 Battery Tray Assembly	\$79.95	
20-0425-R	55-66 Battery Hold down	\$19.95	
20-425-B	60-66 Battery Retainer Bolts w/hdw-pr	\$8.95	
20-425-HK	60-66 Bolt kit-battery box 7 pcs	\$9.95	

20-425-T



20-420-L



20-412-F 60-66 Front sheet metal hardware kit--steel \$99.95
 135 piece kit includes fender to inner fender,radiator support,horn,wheel well to grille, side cowl, headlamp housing, battery tray, hood hinge, inner fender support to firewall, lower fender to cowl, hood latch and support, hood bumper bracket, inner fender brace, rear inner fender brace, hood brace, fender alignment shims and headlamp bezel screws.



20-0425-R

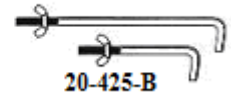

20-412-F

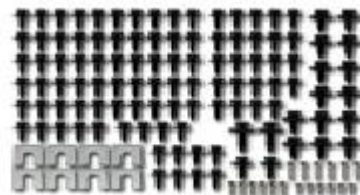

Bill's Truck Shop Limited

Phone (905) 725-3460 / (905) 725-2022 / Fax (905) 404-2302 email: bill@billstruckshop.com

<u>Part No.</u>		<u>New</u>	<u>Used</u>
DOORS-			
<i>Used doors are priced from \$150.00 to \$300.00 depending on dents rust, mirror / mld & speaker holes (doors are bare)</i>			
20-430-60L	60-63 Door		Inquire
20-430-60R	60-63 Door		Inquire
20-430-L	64-66 Door-complete shell	left \$949.95	Inquire
20-430-R	64-66 Door- complete shell	right \$949.95	Inquire



20-430-L

	Panel	DOORS_HATCH	Surburban	
20-430-RL	60-66 Rear Barn Door		left	Inquire
20-430-RR	60-66 Rear Barn Door		right	Inquire
20-430-UH	60-66 Upper Hatch			Inquire
20-430-LG	60-66 Lower Gate			Inquire
Inquire about gate-hatch hardware				



I received the truck box yesterday, it is in amazing shape. Thanks for your great service and honesty. I have many buddies building trucks that I will be passing your card onto. I will send you some pictures once I get the box bolted on. Thanks again Bill.

Bill's Truck Shop Limited

Phone (905) 725-3460 / (905) 725-2022 / Fax (905) 404-2302 email: bill@billstruckshop.com

Fleetside Bed Parts

Group 21

<u>Part No.</u>		<u>New</u>
FRONT BED PANEL		
21-4119-T	60-66 Front Bed Panel wood floor/fleetside-made in Taiwan	\$369.95
21-4714	60-66 Front Bed Panel w/ embossed BOWTIE	\$463.95
23-0387-SS	54-87 Front Bed Panel Hdw Kit- Phillips head stain-steel / step & fleet	\$19.95
23-0387-S	54-87 Front Bed Panel Hardware Kit Zinc bolts / step & fleet	\$11.95
21-4WT	60-66 Wheel Tubs fit L or R	\$159.95
21-4WT-BK	60-66 Bolt kit for wheel tubs 17 pcs-2 sides	\$19.95
Bed side are complete assemblies		
21-4063-L	60-66 Bedside-long fleet-left	\$1349.95
21-4064-R	60-66 Bedside-long fleet-right	\$1349.95
21-4260-SL	60-66 Bed side-short fleet left	\$1195.00
21-4260-SR	60-66 Bed side-short fleet right	\$1195.00
21-4200-S	59-66 Support-fleetside panel each Predrilled holes in-can be welded-screwed or riveted on	\$9.95
21-0402-FK	58-66 Bed to floor brace set -fleetside 4 pcs w/ hdw Can be purchased EACH left or right side	\$89.95 \$20.00
21-0402-FK-C	58-66 Bed to floor brace set -fleetside 4 pcs w /hdw CHROME	\$109.95



21-4119



23-0618-S

21-4WT-BK



21-4WT



21-4200-S

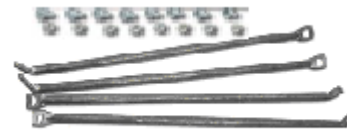
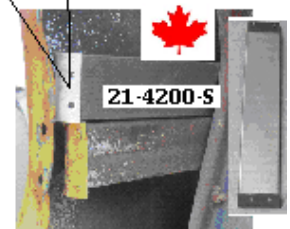

21-0402-FK

Bill's Truck Shop Limited

Phone (905) 725-3460 / (905) 725-2022 / Fax (905) 404-2302 email: bill@billstruckshop.com

Fleetside Bed Parts

Group 21

<u>Part No.</u>		<u>New</u>
	Cross sills are pre-drilled w/ plates- wood floor short fleet have 3 cross sills & 1x 72" reinforcement long fleet have 5 cross sills-3 on front / 2 rear & 1x 72" reinforcement at front of wheel tub	
21-4721	60-62 Rear Cross Sill - fleetside—made in USA	\$269.95
21-0722-T	63-72 Rear Cross Sill -fleetside made in Tawain	\$259.95
21-4434	60-62 Cross Sill - fleetside	\$64.95
21-0722-HK	54-87 Rear cross sill hdw kit step & fleetside 8 5/16 bolts & 4 5/16 tensile nuts	\$13.95
21-0435	63-72 Bed Cross Sills - fleetside w/ plates each	\$59.95
21-0438	60-72 Bed Reinforcement / 1" high strip in front of rear wheel 72 ' galvanized	\$45.95
23-0431	60-72 Bed Reinforcement/ 1' high strip between rear wheels 50 "	\$44.95
	TAILGATES & hardware/ DECALS --- FLEETSIDE	
21-0566-G	58-66 GMC Fleetside Tailgate	\$899.95
21-0566-C	58-66 Chev Fleetside Tailgate	\$899.95
21-0566-B	58-66 Blank Fleetside Tailgate	\$649.95
22-0566	55-66 Tailgate Hinges cadmium plated /FLEETSIDE pair	\$38.95
21-0510-HK	58-72 Bolt kit-fleetside tailgate hinge-4pcs	\$14.95
22-0FZ	58-66 Tailgate Chain & Arm set- Zinc/fleetside – pr	\$49.95
21-0401-S	58-66 Tailgate Chain & Arm set-stainless steel/fleetside – pr	\$99.95
21-0308-Z	58-66 Tailgate Latch Arm Pivot Bolt w/nut - zinc /fleetside each	\$17.95
21-0308-S	58-66 Tailgate Latch Arm Pivot Bolt/nut - stainless steel each	\$24.95
22-0CFG	58-66 Tailgate Chain Covers-grey w/ arm pad	NLA
22-0CFB	58-66 Tailgate Chain Covers-black w/ arm pad	\$16.95
22-0308-BL	58-66 Tailgate Chain Eye Bracket left	\$19.95
22-0308-BR	58-66 Tailgate Chain Eye Bracket right	\$19.95
21-0308-BS	58-66 Support-tailgate chain pivot bolt-in bed side—w/ hdw fir L & R each NEW	\$22.95

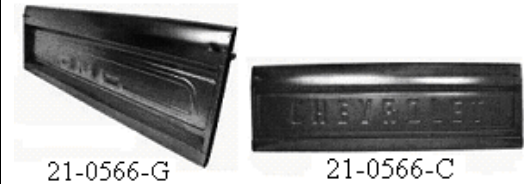
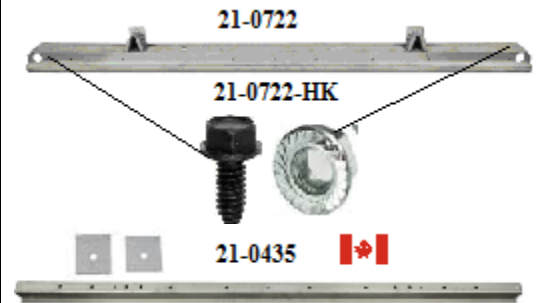

Bill's Truck Shop Limited
 Phone (905) 725-3460 / (905) 725-2022 / Fax (905) 404-2302 email: bill@billstruckshop.com

Fleetside Bed Parts

Group 21

<u>Part No.</u>	<u>FLEETSIDE</u>	<u>New</u>
Tailgate Letters CHEVROLET		
21-0CFW	58-66 white	\$9.95
21-0CFB	58-66 black	\$9.95
21-0CFSS	58-66 brushed stainless steel	\$9.95
Tailgate Letters-fleetside G M C		
21-0GFW	58-66 white	\$9.95
21-0GFB	58-66 black	\$9.95
21-0GFSS	58-66 brushed stainless steel	\$9.95
ROLL PANS		
-Made from 18 gauge electro-galvanized steel & can be screwed or welded into place not primed		
21-4828	60-66 Roll Pan Smooth w/ license box - fleetside	\$259.95
BED PAD SET		
31-0201-P	54-72 Rubber pads under cross sills 10pcs	\$14.95
Fleetside-Tailgate Link kit- w/ instructions		
21-0837	58-66 Tailgate Link Assembly – fleetside arms w/ hdw for removal of chains	\$129.95
21-0837-S	58-66 Tailgate Link Assembly – fleetside arms w/ hdw for removal of chains-stainless steel	\$239.95
21-0266	58-66 Tailgate Latch kit w/ hdw & instruction Zinc /fleetside	\$159.95
21-0266-S	58-66 Tailgate Latch kit w/ hdw & instruction stainless steel /fleetside	\$199.95
TRAILER HITCH		
Hidden tow hitch- receiver sits behind license plate		
22-572-HT	67-72 Trailer hitch w/ flip plate bracket	\$385.00
22-0FLP	Flip down rear plate bkt	\$39.95

CHEVROLET

30-4828



31-0201-P

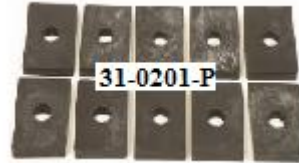

21-0837

21-0266-S



22-0SLK-S



22-572-HT



22-0LFP

Bill's Truck Shop Limited

Phone (905) 725-3460 / (905) 725-2022 / Fax (905) 404-2302 email: bill@billstruckshop.com

Bed Parts

Group 23

Part No.

New

Bed sides are made from 16 gauge electro-galvanized steel and come with angels installed, stake pockets, fender holes, USA are not primed. Bed sides can be ordered with many different options: e.g., no pocket holes SS angels, no fender holes. . Inquire if necessary .Items w/ T are off shore produced parts

23-4641	60-66 Short Bed Side	left	\$789.95
23-4642	60-66 Short Bed Side	right	\$789.95
23-4641-T	60-66 Short Bed Side	left	\$699.95
23-4642-T	60-66 Short Bed Side	right	\$699.95
23-4548	60-62 Long Bed side	left	Inquire
23-4549	60-62 Long Bed Side	right	Inquire
23-4552	63-66 Long Bed Side	left	Inquire
23-4553	63-66 Long Bed Side	right	Inquire

STAKE POCKETS

31-0405	54-72 Stake Pocket--front / left		\$99.95
31-0408	54-72 Stake Pocket--front / right		\$99.95
23-0411	54-66 Stake Pocket right rear		\$139.95
23-0414	54-66 Stake Pocket left rear		\$139.95

FRONT BED PANEL

23-0613-T	60-72 Front Bed Panel-stepside		\$169.95
23-0613	60-72 Front bed panel-stepside USA made		\$269.95
23-0387-SS	54-87 Front Bed Panel Hdw Kit- Phillips head stain-steel / step & fleet		\$13.95
23-0387-S	54-87 Front Bed Panel Hardware Kit Zinc bolts / step & fleet		\$5.25

CROSS SILLS-stepside

short step have 3 cross sills & 2 reinforcements
long step have 5 cross sills & 2 reinforcements

23-4716	60-62 Rear Cross sill USA made		\$259.95
23-4717	63-66 Rear Cross Sill		\$199.95
23-4428	60-62 Cross Sill w/ holes & plates		\$78.95.
			95
23-0429	63-72 Cross Sill w/ holes & plates - galvanized each		\$79.95
23-0431	60-72 Reinforcement strip w /holes 49 1/2 between wheels galvanized		\$39.95



31-0405

23-0414



23-0613



23-4716

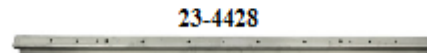

23-4428

Bill's Truck Shop Limited

Phone (905) 725-3460 / (905) 725-2022 / Fax (905) 404-2302 email: bill@billstruckshop.com

Bed Hole Plugs Aluminium plug fits in hole at front and rear of *step side* bed rails. With rubber O-ring -- press in

31-0649	47-66	polished /blank	pair	\$89.95
31-0649-B	47-66	smooth-brushed /blank	pair	\$59.95



Bed Roll Light kit-fit 40-66 bed rolls and 40-87 Mar-k made bed side roll

31-0864	LED lights w/ hdw & instructions	\$229.95
---------	----------------------------------	----------



23-0191	54-87 Stake Pocket Covers – steel w/ side clips	stepside only	pair	\$36.95
23-0192	58-87 Stake Pocket Covers – steel w/ side clips	fleetside only	pair	\$36.95



Bill's Truck Shop Limited

Phone (905) 725-3460 / (905) 725-2022 / Fax (905) 404-2302 email: bill@billstruckshop.com

<u>Part No.</u>			<u>New</u>
TAILGATE			
can also be supplied w/ out chain hook & hole			
STEPSIDE			
23-0SBLANK	54-87 Tailgate	BLANK	\$249.95
23-0SCHEV-T	54-87 Tailgate	w/ CHEV Taiwan made	\$429.95
23-0SCHEV	54-87 Tailgate	w/ CHEV US made	Inquire
23-0SGMC	54-87 Tailgate	w/ GMC	\$499.95
23-0SGMC-A	54-62 Tailgate w/ OE style GMC	script	\$639.95
Tailgate Covers—special order			
23-0682	54-87 Tailgate Cover	w/ embossed BOWTIE	\$241.95
23-0758	54-87 Tailgate Cover	SMOOTH	\$158.95
23-0756	54-87 Tailgate flush	w/ BOWTIE	\$469.95
54-87 TAILGATE LETTERS			
CHEVROLET			
23-0CSW		white	\$9.95
23-0CSB		black	\$9.95
23-0CSS		brushed stainless steel	\$9.95
	54-87 Tailgate Letters	GMC	
23-0GSW		white	\$9.95
23-0GSB		black	\$9.95
23-0GSs		brushed stainless steel	\$9.95
23-0GSB-55	55-62 black w/ OE style	script	\$9.95
TAILGATE TRUNIONS			
22-0547-S	54-87 Cadmium Plated w/ bolts	pair	\$23.95
23-0381	54-87 Urethane w/ SS bolts	pair	\$52.95
TAILGATE CHAINS			
23-0SZ	54-87 Tailgate Chains	cadmium plated pair	\$48.95
23-0SS	54-87 Tailgate Chains	Stainless Steel pair	\$94.95
Tailgate Chain Covers			
22-0CCB	47-87 Tailgate Chain Covers	black pair	\$11.95
22-0CCC	47-87 Tailgate Chain Covers	clear pair	\$11.95

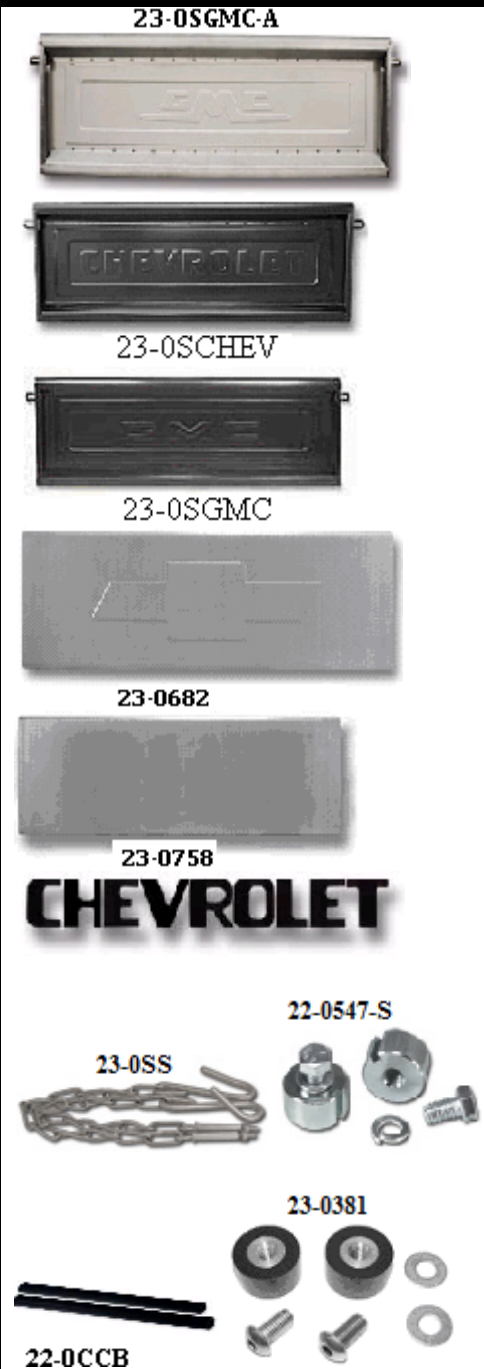

Bill's Truck Shop Limited

Phone (905) 725-3460 / (905) 725-2022 / Fax (905) 404-2302 email: bill@billstruckshop.com

<u>Part No.</u>		<u>New</u>
Tailgate Link kit- w/ instructions		
STEPSIDE		
29-0834	54-87 arms w/ hdw for removal of chains-stepside	\$169.95
	54-87 arms w/hdw for removal of chains	
29-0834-S	stainless steel	\$239.95
FLEETSIDE		
21-0837	58-66 arms w/ hdw for removal of chains- fleetside	\$169.95
	58-66 arms w/ hdw for removal of chains stainless steel - fleetside	
21-0837-S		\$239.95

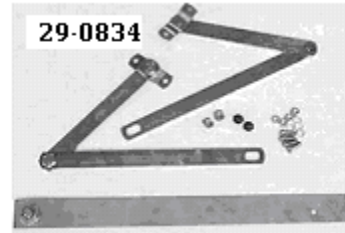

TAILGATE PROTECTOR			
Stainless edge guard			
22-0STP	54-87 Stepside	brushed stainless steel	\$79.95
22-0STP-B	54-87 Stepside	black satin stainless steel	\$79.95
22-0FTP	58-66 Fleetside		coming



1947-72 Stepside Stealth Tailgate Latches			
Slotted stainless barrel w/spring loaded lock pin that is installed into the top gate roll & inserts in gate post			
22-0SLK-S			\$119.95
22-0SLK-Z	Zinc coated		\$94.95
Fleetside			
21-0266-S	58-66 Tailgate Latch kit- w/hdw stainless steel fleetside		\$189.95
21-0266	58-66 Tailgate Latch kit- w/hdw fleetside		\$109.95



Roll Pans

Group 24

Part No.

New

STEPSIDE ROLL PANS

-Made from 18 gauge electro-galvanized steel & can be screwed or welded into place not primed

24-0817	54-87 Roll Pan	smooth w/ out license box-	Inquire
30-0826-T	54-87 Roll Pan	smooth w/ box made in Taiwan	\$224.95
30-0852	54-87 Roll Pan	4 row louvers w/ box	\$259.95
24-0483	54-87 Roll Pan	smooth w/ plate box - long stepside	\$279.95
30-0204-T	47-87 Roll Pan Plate	Light-top mount w / harness	\$9.75



24-0817



30-0826-T



30-0852



30-0204-T

Bill's Truck Shop Limited

Phone (905) 725-3460 / (905) 725-2022 / Fax (905) 404-2302 email: bill@billstruckshop.com



SHORT STEP- lower indent level w/ opening



LONG STEP

Stepside Fenders & Steps

Group 25

<u>Part No.</u>		<u>New</u>
FENDERS-----STEEL		
25-0566-L	55-66 Step Side Fender w/o tire mount left	\$799.95
25-0566-LS	55-66 Step Side fender w/ spare cut out for LONG STEP only left	\$799.95
25-0566-R	55-66 Step Side Fender right	\$799.95
FENDER BRACES		
25-0566-K	55-66 Rear Fender Brace kit 3pc per side	\$26.95
25-0566-SSK	55-66 Rear Fender Brace kit-stainless steel 6 pc set both sides w/ hdw	\$182.95
FENDER WELTING		
31-0FWB	47-72 Black vinyl w/ 3/8 bead 25 ft	\$19.95
FENDER BOLT KITS		
31-0202-SS	47-66 stainless steel w/ clutch bolts	\$62.95
25-06025	47-72 Rear Fender Bolt kit zinc w/ philips head	\$19.95
31-0202-SS-P	47-66 Stainless steel w/philips head screw	\$69.95
STEPS		
25-0410-L	55-66 Short Step left	\$239.95
25-0410-R	55-66 Short Step right	\$239.95
25-0410-LC	55-66 Short Step CHROME left	\$399.95
25-0410-RC	55-66 Short Step CHROME right	\$399.95
25-0411-L	55-66 Long Step-vertical of step is 24 1/2 long left	\$224.95
25-0411-R	55-66 Long Step-vertical of step is 24 1/2 long right	\$224.95
25-0412-L	55-66 Long Step-vertical of step is 28 1/2 long ----left	
25-0412-R	55-66 Long Step-vertical of step is 28 1/2 long right	
25-410-SL	60-66 Step Support left	\$39.95
25-410-SR	60-66 Step Support right	\$39.95
25-0510-BK	55-72 Step Bolt kit @ support, sides & fender-Zinc	\$18.95

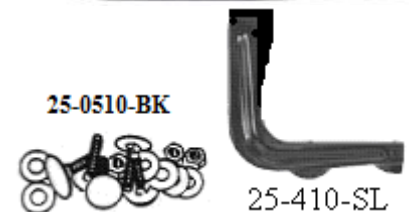
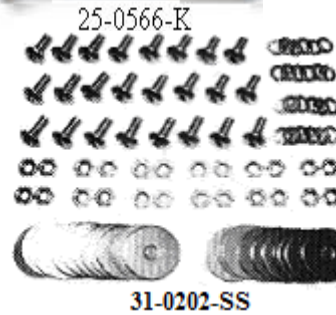
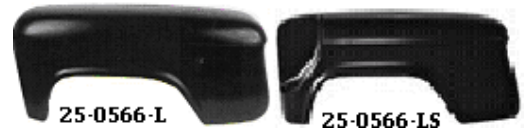

Bill's Truck Shop Limited

Phone (905) 725-3460 / (905) 725-2022 / Fax (905) 404-2302 email: bill@billstruckshop.com

Stepside Fenders & Steps

Group 25

<u>Part No.</u>		<u>New</u>	<u>Used</u>
25-0510-BKS	55-72 Step Bolt kit chrome w/ hdw -4 bolts	\$32.95	
32-004	47-87 Running board step plates-polished aluminium/ diamond pattern & CHEVY logo in center pair w/ hardware	\$99.95	
32-005	47-87 Running board step plates non pol alum w /older GMC design 5x10 5/8 pr	89.95	
27-4120-L	60-66 Rock Deflector-L OE style w / brace	\$45.00	
27-4120-R	60-66 Rock Deflector-R OE style w/ brace	\$45.00	

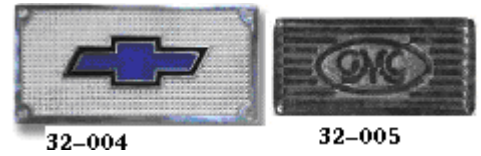

27-4120-L



BED STRIPS

Stainless Steel w/o holes

26-0634	78 " long PST w/o holes	each	\$44.95
26-0160	89 " long PST w/o holes	each	\$59.95
26-0336	120" long PST w/o holes	each	\$84.95

Steel Strips w/o holes

26-0008	97 " long w/o holes	each	\$39.95
26-0383	120" long w/o holes	each	\$59.95

Custom "WOW" Bed Strips w/ hidden fasteners

Polished Stainless Steel: (PST) custom strips w/ "T" type bolt slides on bottom of strip

26-0095	" T " boltw /hdw as required	each	\$6.00
26-0083	up to 97 " long - cut to fit	each	\$99.00

Bed Strip Kit (step side)

26-0083-K	7 PSTstrips 82 " w/ 49 "T" bolts and angle side hdw		\$699.95
-----------	---	--	----------

Exhaust Heat Shield -to shield exhaust on wood floor over rear axle-prevents wood from burning

26-0734	47-72 includes hdw	each	\$16.95
---------	--------------------	------	---------

Custom Bed Strips w/ hidden fasteners



26-0734



Bill's Truck Shop Limited

Phone (905) 725-3460 / (905) 725-2022 / Fax (905) 404-2302 email: bill@billstruckshop.com

Stepside/Fleetside Bed Floor Wood- Strips

Group 26

Part No.

New

WOOD-Top show quality bed strips
 , kiln dried, cut to size, sanded and grooved for bed strips 3/4 " thick w/ out
mount holes includes finishing instructions

RED OAK

26-0240	60-72 Short Step	\$654.95
26-0256	60-72 Long Step	\$659.95
26-0262	60-72 Short Fleet	\$824.95
26-0266	60-72 Long Fleet	\$964.95

YELLOW PINE

26-0211	60-72 Short fleet w/o mount holes	\$699.95
---------	-----------------------------------	----------

BOX BED STRIP SETS

STEEL

26-4021	60-66 Short Step-steel 7 pcs	\$139.95
26-4075	60-66 Short Fleetside-steel	\$159.95
26-4060	60-62 Long Step-steel 7 pcs	\$169.95
26-4063	63-66 Long Step-steel 7 pcs	\$169.95
26-4087	60-62 Long Fleetside-steel	\$229.95
26-4090	63-66 Long Fleetside-steel	\$229.95

POLISHED STAINLESS STEEL

26-4019	60-66 Short Step	\$289.95
26-4055	60-62 Long Step	\$299.95
26-4061	63-66 Long Step 97"	\$324.95
26-4073	60-66 Short Fleetside-PST	\$374.95
26-4085	60-62 Long Fleetside-PST	\$439.95
26-4088	63-66 Long Fleetside-PST	\$389.95

ANGLE STRIPS

STEEL

26-4117	60-66 Short Step -steel	Pair	\$54.95
26-4153	63-66 Long Step -steel	Pair	\$99.95
26-4150	60-62 Long Step - steel	Pair	\$99.95

POLISHED STAINLESS STEEL

26-4115	60-66 Short Step	Pair	\$99.95
26-4151	63-66 Long Step	Pair	\$124.95



Bill's Truck Shop Limited

Phone (905) 725-3460 / (905) 725-2022 / Fax (905) 404-2302 email: bill@billstruckshop.com

Stepside/Fleetside Bed Floor Strips- Bolts

Group 26

Part No.

New

BED BOLT KITS

Includes all bolts, washers & nuts for bed strips & in sides and for mounting bed to frame /Zinc & Polished Stainless Steel

ZINC

26-4362	60-66 Short Step	\$89.95
26-4293	60-62 Long Step	\$99.95
26-4296	63-66 Long Step	\$99.95
26-4308	60-66 Short Fleetside	\$99.95
26-4317	60-62 Long Fleetside	\$124.95
26-4320	63-66 Long Fleetside	\$124.95



POLISHED STAINLESS STEEL

26-4360	60-66 Short Stepside	\$194.95
26-4291	60-62 Long Step	\$199.95
26-4294	63-66 Long Step	\$229.95
26-4306	60-66 Short Fleetside	\$229.95
26-4315	60-62 Long Fleetside	\$274.95
26-4318	63-66 Long Fleetside	\$279.95



BED BOLTS-angle & strips only

POLISHED STAINLESS STEEL

26-4394	60-66 Long Fleet	\$118.75
---------	------------------	----------

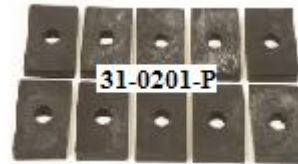

BED to FRAME BOLT only

ZINC

26-4423	60-66 Short Step	\$59.95
26-4451	60-66 Short Fleet	\$59.95

28-0211



POLISHED STAINLESS STEEL

26-0617	60-72 short or long step or fleet	\$89.95
---------	-----------------------------------	---------

BED MOUNTING PADS

31-0201-P	54-72 rubber/10 pcs	\$12.95
-----------	---------------------	---------

Bed Floor Offset Washers

28-0211	1½ w/ offset 1/2 square hole polished stainless steel- each	\$12.95
---------	---	---------

Bill's Truck Shop Limited

Phone (905) 725-3460 / (905) 725-2022 / Fax (905) 404-2302 email: bill@billstruckshop.com

Repair Panels

Group 27

<u>Part No.</u>			<u>New</u>
27-4101	60-66 Rocker Panel OE style	left	\$79.95
27-4102	60-66 Rocker Panel OE style	right	\$74995
27-0301	60-72 Rocker Panel Backing Plate	each	\$19.95
27-4211	60-66 Door "A" Pillar-front -lower L		\$69.95
27-4212	60-66 Door "A" Pillar-front -lower R		\$69.95
27-4213	60-66 Door Pillar "B" rear lower	left	\$59.95
27-4214	60-66 Door Pillar "B" rear lower	right	\$59.95
49-0614	60-66 Bolt-cab floor to "B" pillar 3/8 floating washer- 3 required at each pillar	each	\$3.50
27-4217	60-62 Front Floor Pan w/ correct cab mount bolt hole & trans cover provisions	left	\$159.95
27-4218	60-62 Front Floor Pan w/ correct cab mount bolt hole and trans cover provisions	right	\$159.95
27-4219	63-66 Front Floor Pan w/ nuts for high hump bolt in trans cover	left	\$149.95
27-4220	63-66 Front Floor Pan w/ nuts for high hump bolt in trans cover	right	\$149.95
27-4221-B	60-66 Front Floor Pan -generic fit for low lump floor	left	\$74.95
27-4222-B	63-66 Front Floor Pan-generic fit for low lump floor	right	\$74.95
27-4223	63-66 Floor Rear-outer w/ inner rocker-left 29" long & 9" wide w/ 60-63 w/ rear harness plug hole		\$104.95
27-4224	60-66 Floor Rear-outer w/ inner rocker -right 29"long & 9"wide w/ 60-63 w/rear harness plug hole		\$104.95
27-4227	60-66 Floor Outer w/ inner rocker-left- 50" long & 8"wide w/ 60-63 rear harness plug hole		\$144.95
27-4228	60-66 Floor Outer w/ inner rocker-right- 50" long & 8"wide w/ 60-63 rear harness plug hole		\$144.95
27-4225	60-66 Footwell	left	\$52.95
27-4226	60-66 Footwell	right	\$52.95
27-4309	60-66 Front Cab Support original style	each L/R	\$43.95
27-0307	60-72 Rear Cab Floor Support original style (new tooling)	left	\$37.95
27-0308	60-72 Rear Cab Floor Support original style (new tooling)	right	\$37.95
27-4319	60-66 Cab floor brace front to rear 49 1/2" long	left	\$99.95
27-4320	60-66 Cab floor brace front to rear 49 1/2" long	right	\$99.95



Bill's Truck Shop Limited

Phone (905) 725-3460 / (905) 725-2022 / Fax (905) 404-2302 email: bill@billstruckshop.com

Repair Panels

Group 27

<u>Part No.</u>		<u>New</u>
27-4115	60-66 Cab corner 9 ¾ x 10 ½ left	\$39.95
27-4116	60-66 Cab corner 9 ¾ x 10 ½ right	\$39.95
27-4117	60-66 Cab lower-ext from cab corner 33" long-L	\$129.95
27-4118	60-66 Cab lower-ext from cab corner 33" long-R	\$129.95
27-4240	60-66 Door Skin Panel 11 " high fits L or R Door skin can also be used on 60-63-some modification required at top ft end	\$64.95
27-4241-L	64-66 Door Skin-full replacement - can also be fitted on 60-63- includes OE mirror holes left	\$229.95
27-4242-R	64-66 Door Skin-full replacement - can also be fitted on 60-63- includes OE mirror holes - right	\$229.95
27-4269	60-63 Inside Door Bottom left	\$130.95
27-4270	60-63 Inside Door Bottom right	\$130.95
27-4271	64-66 Inside Door Bottom 9 " high left	\$89.95
27-4272	64-66 Inside Door Bottom 9 " high right	\$89.95
27-4240	60-66 Door Skin Panel 11 " high fits L or R	\$69.95

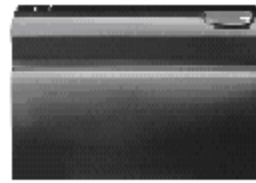
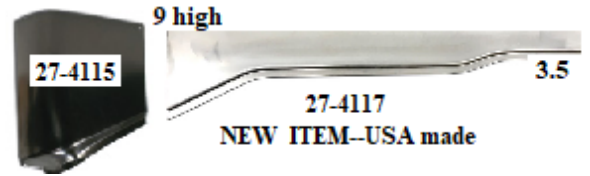

27-4241-L



27-4240



27-4271

Bill's Truck Shop Limited

Phone (905) 725-3460 / (905) 725-2022 / Fax (905) 404-2302 email: bill@billstruckshop.com

Repair Panels

Group 27

<u>Part No.</u>		<u>New</u>
27-4340-LH	63-66 Cab floor -complete w/ braces -low hump trans cover - torsion bar frame front mount hole further in from rocker	\$1395.95
27-4340-HH	63-66 Cab floor -complete w/ braces -high hump trans cover - torsion bar frame front mount hole further in from rocker---NEW	\$1399.95
27-4339	60-62 Cab floor-complete w/ braces w/o trans cover -w/ high hump floor w/ torsion bar frame-- front mount hole further in from rocker	\$1395.95
27-4339-TC	60-63 Trans floor cover -low hump -trucks w/ torsion ft suspension	\$246.95
27-4339-HTC	60-63 Trans floor cover -high hump -trucks w/ torsion ft suspension has shifter hole	\$259.95
27-4339-FE	60-62 Extension-firewall to floor w/ low hump	\$105.00
27-4339-HFE	60-62 Extension-firewall to floor w/ high hump floor	\$169.00



Bill's Truck Shop Limited

Phone (905) 725-3460 / (905) 725-2022 / Fax (905) 404-2302 email: bill@billstruckshop.com

Repair Panels

Group 27

<u>Part No.</u>		<u>New</u>
27-4339-F	60-63 Firewall w/ low hump floor w/ factory holes	\$699.95
27-4340-F	63-66 Firewall w/ factory holes	\$699.95
27-4237	60-66 Roof upper/inner brace kit-L	\$186.00
27-4238	60-66 Roof upper/inner brace kit-R	\$186.00
27-4280	60-66 Cab roof outer skin	\$599.95
27-4261	60-66 Roof repair panel-inner@ windshield 6 " wide can also be used on 60-63 up to the sunvisor holes	\$189.95
27-4260	60-66 Roof Repair Panel- outer @ windshield seam to seam & from pinch weld to drip rail	\$189.95
27-4283	60-63 Roof-inner roof panel	coming
27-4284	64-66 Roof-inner roof panel	\$724.95
27-4268	60-66 Inner big back window panel	\$579.95

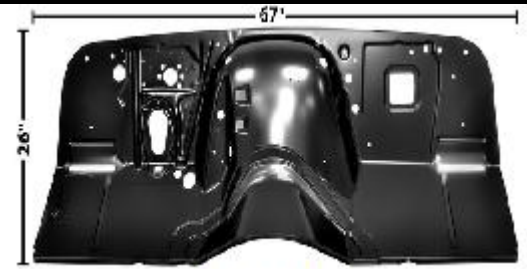

27-4340-F



27-4238

27-4280

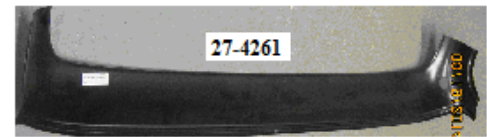

27-4261



27-4260



27-4268

Bill's Truck Shop Limited

Phone (905) 725-3460 / (905) 725-2022 / Fax (905) 404-2302 email: bill@billstruckshop.com

Repair Panels

Group 27

<u>Part No.</u>		<u>New</u>		
27-4333	60-66 Air Vent Cowl-outer	left	\$79.95	
27-4334	60-66 Air Vent Cowl-outer	right	\$79.95	
27-4032	62-66 Hood Outer front replacement panel- Chev w/ park light holes	NEW ITEM!!	\$449.95	
27-4033	62-66 Hood outer front replacement panel 9"- Chev	NEW ITEM!!	\$249.00	
BED----bed side patch panels can be used on panel/surburban				
27-4141	60-66 Bed Front Lower 8 ft bed 39" x 9" H	left	\$114.95	
27-4142	60-66 Bed Front Lower 8 ft bed 39" x 9" H	right	\$114.95	
27-4141-6L	60-66 Bed Front Lower 6 ft bed 27" x 9" H	left	\$99.95	
27-4142-6R	60-66 Bed Front Lower 6 ft bed 27" x 9" H	right	\$99.95	
27-4143	60-66 Bed Rear Lower- 6 ft bed 8" H	left	\$99.95	
27-4144	60-66 Bed Rear Lower- 6 ft bed 8" H	right	\$99.95	
27-4147	60-66 Bed Wheel Arch- 33" x 8"	short bed only left	\$109.95	
27-4148	60-66 Bed Wheel Arch 33" x 8"	short bed only right	\$109.95	
27-4150	60-66 Bed Side End Cap	right	\$110.95	
27-4151	60-66 Bed Side End Cap	left	\$110.95	



27-4333



27-4032



27-4033

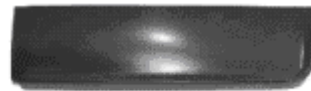

27-4143



27-4147

27-4142-6R



27-4150

Bill's Truck Shop Limited

Phone (905) 725-3460 / (905) 725-2022 / Fax (905) 404-2302 email: bill@billstruckshop.com

Part No.

New

Body Side Trim-all mounting hardware is included with each pcs

62-66 PICKUP short & long bed

T -offshore brand other USA made

28-4225	62-66 Ft Fender Tip mld	L & R	Inquire
28-4225-T	62-66 Ft Fender Tip mld	L & R	Inquire
28-4226	62-66 Ft Fender mld	L & R	Inquire
28-4226-T	62-66 Ft Fender mld	L & R	Inquire
28-4227	62-66 Door Mld-upper	L & R	Inquire
28-4227-T	62-66 Door Mld-upper	L & R	Inquire
28-4228	62-66 Cab mld-upper	R	Inquire
28-4228-T	62-66 Cab mld-upper	R	Inquire
28-4229	62-66 Cab mld-upper-	L	Inquire
28-4229-T	62-66 Cab mld-upper	L	Inquire
28-4230	62-66 Bed mld-upper/long bed	L & R	Inquire
28-4230-T	62-66 Bed mld-upper/long bed	L & R	Inquire
28-4231	62-66 Bed mld- upper/short bed	L & R	Inquire
28-4231-T	62-66 Bed mld- upper/short bed	L & R	Inquire
28-4232	62-66 Door mld-lower	R	Inquire
28-4232-T	62-66 Door mld-lower	R	Inquire
28-4233	62-66 Door mld-lower	L	Inquire
28-4233-T	62-66 Door mld-lower	L	Inquire
28-4234	62-66 Cab mld- lower	L & R	Inquire
28-4234-T	62-66 Cab mld- lower	L & R	Inquire
28-4235	62-66 Bed mld-lower-long bed	L & R	Inquire
28-4235-T	62-66 Bed mld-lower-long bed	L & R	Inquire
28-4236	62-66 Bed mld-lower- short bed	Jason L& R	Inquire
28-4236-T	62-66 Bed mld-lower-short bed	L & R	Inquire

60-66 Body Mld Kits-add hdw as required

28-4266-SU	62-66 Kit Body Mld kit w/ hdw-short fleet made in USA		\$999.95
28-4266-ST	62-66 Kit Body Mld kit w/ hdw-short fleet		\$699.95
28-4266-LU	62-66 Kit Body Mld kit w/hdw-long fleet made in USA		\$1350.00
28-4266-LT	62-66 Kit Body Mld kit w/hdw-long fleet		\$749.95
28-4266-GS	62-66 Kit Body Mld kit w/hdw-short fleet - GMC made in US		\$529.95
28-4266-GST	62-66 Kit Body Mld kit w/hdw-short fleet- GMC		Inquire
28-4266-GL	62-66 Kit Body Mld kit w/hdw-long fleet- GMC made in USA		Inquire
28-4266-GLT	62-66 Kit Body Mld kit w/hdw-long fleet- GMC		Inquire

62-66 GM FLEETSIDE MOULDINGS

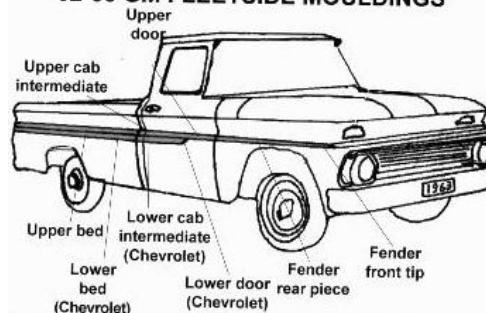

Bill's Truck Shop Limited

Phone (905) 725-3460 / (905) 725-2022 / Fax (905) 404-2302 email: bill@billstruckshop.com

Moulding Clips & Nuts

Group 29

<u>Part No.</u>		<u>New</u>	<u>Used</u>
MOLDING Clips & Nuts			
28-4MHK	62-66 Mld Hardware kit - long and short bed #25 -replacement for original plastic push in	\$174.95	
28-4MHK-G	62-66 Mld hardware kit-long and short GMC w/ up mlds only	\$69.95	
29-Clip-25	62-66 Upper Mld Clip-screw on type w/ nut-10-24 x 19/32	\$1.75	
29-Clip-30	62-66 Lower Mld Spring Clip w/seal each	\$2.95	
29-Clip-31	62-66 Upper Mld Spring Clip w/ seal each	\$2.95	
29-Clip-12	62-66 Upper Mld Clip- nut on	\$1.95	
29-Clip-32	62-66 Door Mld Clip w/ nut 60-66 GMC each	\$2.00	
Nut-1	Emblem pin tube nuts 1/8 stud & 1/4 hole	\$0.75	
Nut-2	Emblem pin tube nuts 3/16 stud & 7/32 hole	\$0.75	
Nut-3	Emblem pin speed nut 3/16 stud 1/2 dia	\$0.75	
Nut-4	Emblem pin speed nut 1/4 stud 10/32 dia	\$0.30	
CHEV-CUSTOM CAB MLDS			
28-450-60	60-63 Chev Custom Cab mlds -stainless steel w/ hdw -Chev logo (red) & CUSTOM w/ black details	\$399.95	Inquire
28-450-64	64-66 Chev Custom Cab mlds w/ hdw- aluminium w/ CUSTOM and black details	\$389.95	Inquire
28-450-RK	60-66 Retainer kit-cab pillar mld w/ hdw	\$17.95	
GMC-CUSTOM CAB-DOOR MLDS			
29-Clip-32	60-66 Door Mld Clip w/ nut 60-66 GMC each	\$2.00	
28-455-60	60-63 Trim Mld around window on door pair 64-66 Trim Mld around window on door pair	\$200.00	
28-455-64		\$200.00	
28-456-60	60-66 Trim Mld set @ rear cab pillar 6 pc set	\$200.00	
28-457-60	60-66 CUSTOM Sign on rear cab pillar pair	\$80.00	
DOOR VENT SHADES			
28-4053	60-63 Door Vent Shades w/hdw stainless steel pair	\$64.95	
28-4056	64-66 Door Vent Shades w/ hdw stainless steel pair	\$64.95	

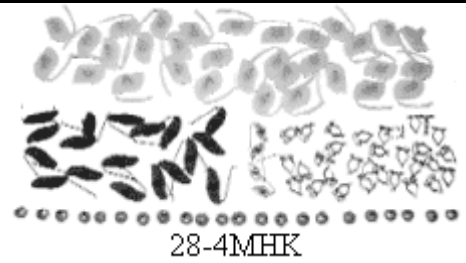

28-4MHK



29-CLIP-31

29-CLIP-30

29-Clip-25



28-450-64

28-450-60



28-450-RK

28-4053



Bill's Truck Shop Limited
Phone (905) 725-3460 / (905) 725-2022 / Fax (905) 404-2302 email: bill@billstruckshop.com

Emblems

Group 30

Part No.

New

All emblems are in pairs & include mount hardware

CHEV Fender

30-460-10	60-60	Fender	CHEVROLET	\$109.95
30-461-10	61-61	Fender	APACHE 10	\$109.95
30-462-10	62-62	Fender	10 w/bowtie	\$119.95
30-463-10	63-63	Fender	10 w/bowtie	\$119.95
30-464-10	64-64	Fender	10 w/bowtie	\$119.95
30-465-10	65-65	Fender	10 w/bowtie	\$119.95
30-466-10	66-66	Fender	10 w/bowtie	\$119.95

CHEV_HOOD

30-460-H	60-61	Hood emblem-	<u>Inquire</u>
30-460-H-V8	60-61	Hood emblem w/ V 8	<u>Inquire</u>



Bill's Truck Shop Limited
 Phone (905) 725-3460 / (905) 725-2022 / Fax (905) 404-2302 email: bill@billstruckshop.com

Emblems

Group 30

<u>Part No.</u>		<u>New</u>
HUB CAPS-ACCESS/ OPTIONS/TRIM RINGS-RALLEY CAPS-PLASTIC		
31-0412	67-87 Rally Wheel Trim Ring set of 4 15 x 2.5	\$168.00
31-0413	67-87 Rally Wheel Trim Ring EACH 15 x 3	\$59.95
Beauty Ring (stainless steel)		
24-007-15S	15 inch w/ smooth face each	\$44.95
24-007-15R	15-inch w/ ribbed face each	\$48.95
24-007-16S	16 inch w/ smooth face each	\$44.95
24-007-16R	16 inch w/ ribbed face each	\$48.95
31-0520-C	71-87 Rally Wheel Caps w/ CHEV logo & hdw set of 4 -OE GM w/ 5 stud rims	Inquire
31-0520-CD	71-87 Rally Wheel Cap Decal w/ CHEV 2 1/2" dia w/ 5 stud wheels OE metal style pair	\$10.95
31-0520	71-87 Rally Wheel Caps w/ CHEV logo & hdw w/ 5 stud rims each	\$39.95
31-0774-G	71-87 Rally Wheel Caps w/ GMC logo & hdw -5 stud rims OE GM set of 4	Inquire
31-0774-GI	71-87 Rally Wheel Cap Decal w/ GMC logo 2 1/2" dia w/ 5 stud wheels OE aluminum w red pair	\$29.95
31-0774-GD	71-87 Rally Wheel Cap Decal w/ GMC logo 2 1/2" dia w/ 5 stud wheels pair	\$10.00
31-0774	71-87 Rally Wheel Caps w/ GMC logo & hdw s w/ 5 stud rims each	\$42.95
31-0522-C	71-87 Rally Wheel Cap w/ Chev logo ea. 6 Stud	\$49.95
31-0522	71-87 Rally Wheel Cap/ 6 stud -plastic w open end each	\$44.95
31-0521-4x4	71-87 Cap-ralley wheel-6/stud-closed w/4x4-each	\$39.95
31-0521-CD	71-87 Rally Wheel Cap Decal w/ CHEV logo-vinyl stick on w/ 6 stud rally wheels pair	\$10.00
31-0521-CDB	71-87 Rally Wheel Cap Decal w/ BLUE CHEV logo- vinyl stick on w/ 6 stud rally wheels pair	\$10.00
31-0521-GD	71-87 Rally Wheel Cap Decal w/ GMC logo-vinyl stick on w/ 6 stud rally wheels pair	\$10.00
24-0305-57	57-60 Hub Caps chrome w/ black painted details CHEV only each	\$99.95
31-405-64	64-66 Hub Caps chrome w red painted details CHEV only each	\$114.95

31-0412 31-0413



24-007-15S



31-0774-G

31-0520-C



31-0521-4X4



31-0522

31-0520-CD



24-0305-57



31-405-64

Bill's Truck Shop Limited

Phone (905) 725-3460 / (905) 725-2022 / Fax (905) 404-2302 email: bill@billstruckshop.com

ENGINE-TRANS

Group 36

<u>Part No.</u>		<u>New</u>	<u>Used</u>
36-0810	63-72 Flywheel Cover w/400 trans	\$89.95	
41-0089	63-72 Flywheel cover w/ powerglide trans 6 & 8 cyl (plastic) w/ hdw	\$89.95	
41-0471	69-72 Flywheel cover- will fit all 350 auto trans 6 or 8 cyl (plastic)	\$89.95	
36-0908	55-72 Flywheel Cover 3 & 4 speed trans	\$44.95	\$20.00
41-0477	55-72 Flywheel cover lower V8	\$87.95	\$30.00
41-0231	54-62 Clutch kit 10 1/2" clutch w/ pressure plate release bearing.pilot bushing all w/ 3 speed transmission NEW	\$325.95	
41-0221	63-76 Clutch kit 10 1/2" clutch w/ pressure plate release bearing.pilot bushing all w/ 3 speed transmission NEW	\$345.00	
41-0232	62-78 Clutch kit 12" clutch w/ pressure plate release bearing.pilot bushing V8 NEW	\$265.95	
41-0440	47-87 Pilot Bushing- brass-6 & 8 cyl	\$19.95	
17-4404	60-62 & 60-66 C30 up Master Cylinder- dual master for brake & clutch 1 1/8 bore	\$141.00	
36-0470-RS	63-72 Clutch Fork Return Spring	\$10.95	
10-0909	60-72 Clutch Fork Boot at bell housing	\$14.95	
41-0086	38-75 Clutch release bearing 6 cyl & most V8 1 7/8 long	\$79.95	
41-0087	47-84 Clutch release bearing 1 1/4 long	\$64.95	
41-4124	60-62 Clutch Slave Cylinder with/ 1" bore	\$99.95	
41-4129	60-66 Brake Pedal arm		\$20.00
41-4450	60-66 Clutch Pedal Arm Assembly		\$50.00
41-4450-S	60-66 Spring-Clutch & brake pedal return @ under dash cross shaft	\$11.95	\$5.00
7-0413	60-72 Clutch Pedal Cross shaft Bushing (nylon) approx 3/4" dia 2 required each	\$6.50	
7-0550-B	60-72 Brake Pedal Cross shaft Bushing (nylon) approx 1" dia 2 required each	\$8.50	
7-451-B	60-66 Brake Pedal Arm Assembly		\$50.00



Bill's Truck Shop Limited

Phone (905) 725-3460 / (905) 725-2022 / Fax (905) 404-2302 email: bill@billstruckshop.com

ENGINE-TRANS

Group 36

<u>Part No.</u>		<u>New</u>	<u>Used</u>
7-451-R	63-66 Clutch Rod w/ swivel -pedal to Z-bar-- - 2x2 w/V8	\$14.95	
36-0470	63-72 Clutch Push Rod Wedge @ fork	\$9.00	
36-0470-F	63-72 Clutch Fork		\$15.00
36-4471	63-66 Z bar-clutch 6 & 8 cyl		\$50.00
36-0470-RS	63-72 Clutch Fork Return Spring	\$9.95	
36-0470	60-72 Clutch Push Rod Wedge @ fork	\$11.95	
36-0470-P	60-72 Pivot-clutch adjust rod	\$29.95	
36-0470-C	Clip-shift and clutch linkage-each	\$2.50	
36-0125-K	63-72 Clutch Z-bar seal and bushing kit – includes nylon bushings,2 dust seals,-clip & grease fitting	\$16.95	
36-0123	63-72 Clutch Ball Stud-on frame bracket w/ washer & nut	\$12.50	
36-0123-K	63-72 Keeper-ball stud on frame bkt	\$4.95	
36-0124	63-72 Clutch Ball Stud-engine side 8 cyl K10/20	\$18.50	
36-0125-K	63-72 Clutch Z-bar seal and bushing kit – includes nylon bushings,2 dust seals,-clip & grease fitting	\$14.50	
36-0125-S	63-72 Seal -Z-bar seal pair	\$6.00	
36-0125-B	63-72 Bushing/nylon -Z-bar pair	\$8.00	
36-0125-C	63-72 Clip-Z-bar retainer clip	\$2.00	
36-0125-G	Grease fitting 1/8 straight	\$0.75	
			\$40.00
			\$75.00
			\$75.00
36-5126-V	67-72 Clutch Z-bar engine bracket-V8 bracket on engine	\$38.95	
41-0217	38-72 Clip-clutch fork ball stud retainer	\$14.95	
41-0216-S1	55-72 Ball stud 3/4 " shaft-V8 only	\$22.85	
Std column & linkage parts			
39-4020	60-66 Shift lever rod adjuster lock w/lock ring		\$10.00
39-0722	Lock ring-adjustor pair	\$4.50	

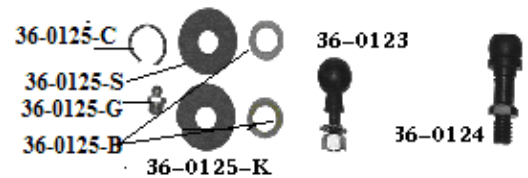
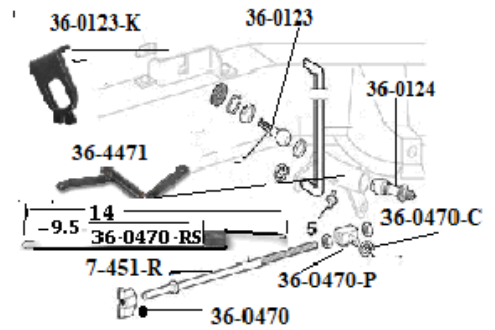

Bill's Truck Shop Limited

Phone (905) 725-3460 / (905) 725-2022 / Fax (905) 404-2302 email: bill@billstruckshop.com

ENGINE-TRANS

Group 36

41-0200	55- 87 Speedo Driven Gear Housing-(bullet)	\$39.95
63-87-- 350 aut -2 speed powerglide & some 3-4 speed Saginaw transmission speedometer driven gear-less teeth to increase odometer MPH 63 up 2" long & 62 and under 3" long		
41-0221-18	Speedo driven gear-brown w/ 18 teeth	\$14.95
41-0221-19	Speedo driven gear- white w/19 teeth	\$14.95
41-0221-20	Speedo driven gear-dark blue w/20 teeth	\$14.95
41-0221-21	Speedo driven gear-red w/21 teeth	\$14.95
41-0221-24	Speedo driven gear-yellow w/24 teeth	\$14.95
41-0221-25	Speedo driven gear-natural w/25 teeth	\$14.95
41-0221-22	62 under Speedo driven gear-green w/22 teeth 3 "	\$14.95
41-0200	55- 87 Speedo Driven Gear Housing-(bullet)	\$14.95
41-0202	Retainer-Speedo drive gear-350-400-460	\$9.00
41-0054	55-72 Rear Tailstock Seal w/ bushing-3 speed Std transmission	\$42.95
41-0041	55-72 Rear Tailstock Seal -3 speed Std transmission	\$6.65
41-5301	67-72 Trans Gsk set 3- speed Saginaw	\$29.95
41-0090	60-72 Clip- auto cooler transmission line retainer-pr	\$2.95
41-02TG-4	39-72 SM420 & 48-65 Muncie 4 speed Gasket set	\$19.95
41-0369	55-87 Driveshaft U-joint w/ 3 speed or automatic 1/2 ton each	\$39.95
41-0331	60-66 w/ 4 speed (3-5/8 dia w/ 1-3/16 cup) 1/2 and 3/4	\$36.95
41-0021	U-joint retainer 1 3/8 center to center each	\$10.95
41-0022	U-joint retainer 1 1/2 center to center each	\$10.95
41-0023	U-joint retainer 1 3/4 center to center-metric each	\$11.95
Transmission Gasket Set		
41-03TG-3	55-66 3 speed	\$44.95
41-02TG-4	39-72 SM420 & 48-65 Muncie 4-speed	\$29.95

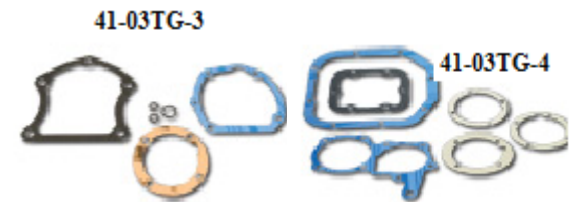
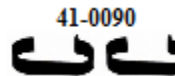

Bill's Truck Shop Limited

Phone (905) 725-3460 / (905) 725-2022 / Fax (905) 404-2302 email: bill@billstruckshop.com

41-0955	69-87 Universal detent cable for 250/250C/350/350C auto trans	\$38.95
41-0951	Kickdown cable—OE style 350 auto 6 & 8 cyl 34 " mount length—1/2 trans inlet w/ grommet	\$39.95
Transmission Cooler		
41-00TC-15	15 " dual pass external -aluminum	\$89.95
41-0026-SB	Universal-bracket auto kick down -SB w/ 350 trans	\$19.95
36-5337	69-72 Alt Bracket-OE cast w/ adjust bracket-- small block V 8- can be used on any SB w/ holes in end of cylinder head	\$129.95
36-5338	67-72 Alternator support-big block-left side w/ short	\$94.95
36-0530	63-76 Belt-alternator V8	\$34.95



Bill's Truck Shop Limited

Phone (905) 725-3460 / (905) 725-2022 / Fax (905) 404-2302 email: bill@billstruckshop.com

ENGINE

Group 36

<u>Part No.</u>		<u>New</u>
36-0109	60-87 Grommet-PCV in valve cover	\$5.95
36-0105	64-87 Grommet-PCV avae cover 6 cyl	\$8.95
36-0PCH	60-87 Hose-PCV w/clamps-OE style 3/8 40 "	\$14.95
41-0225	47-63 Rear Axle Plug 1" w/ gasket	\$10.50
36-0178	68-91 PC Valve V/8 w/ single line	\$6.75
41-0299	58-74 Dip Stick w/ tube STEEL V8 small block OE design-always confirm correct amount of oil to stick marks	\$34.95
41-0919	55-87 Harmonic Balancer seal repair kit- 6 & 8 cyl	\$24.95
41-0015	62-74 Hold down kit small block V8 complete set	\$19.95
41-0201-54	49-72 Oil Cap- on valve cover/vented 6 cyl	\$10.95
41-0301-55	55-72 Oil Cap -on fill spout /vented V/8	\$8.95
41-0302	69-87 Oil cap in valve cover-rubber w/ script	\$11.95
41-0461	56-68 SB V 8 oil filter adaptor—from cannister type to spin on filter	\$69.95
41-1143	56-68 V8 Cartridge oil filter	\$24.95
41-0249L	47-62 Oil Lines to Filter Cannister-6 cylinder	\$44.95



Bill's Truck Shop Limited

Phone (905) 725-3460 / (905) 725-2022 / Fax (905) 404-2302 email: bill@billstruckshop.com

Group 41

ENGINE

<u>Part No.</u>		<u>New</u>
41-0DVA	47-62 Dist Vac Advance 6 cyl w / manual trans	\$57.95
41-0RC-7	55-62 Rad Cap OE Delco 7 lb	\$19.95
41-0RC-7B	55-62 Rad Cap lb replacement	\$12.95
41-0RC-16	47-87 Rad Cap 16 lbs replacement	\$13.95
41-0453	58-66 Thermostat housing V8	\$19.95
41-0454	V8 engine/aluminum w/gasket-angle	\$24.95
18-0160	Thermostat 160 deg	\$14.95
18-0180	Thermostat 180 deg	\$14.95
18-0195	Thermostat 195 deg	\$14.95
41-0235	55-62 Chev water pump w/o pulley 6 cyl 6 cyl--Check pump casting #--height from impeller to fan mount--does it require top by- pass outlet	\$169.95
41-0236	63-74 Water Pump-230 & 250 CI	\$69.95
41-0237	65-74 Water Pump 292 CI	\$89.95
41-0898	55-72 Water Pump SB V8 (new)	\$109.95
41-0515	55-95 Gaskets-water pump v-8 pr	\$10.90
	Water pump- intake heater hose fitting- 6 and 8 cyl -each	
41-0058	5/8 hose fitting 1 1/2 ' long	\$11.95
41-0034	3/4 hose fitting 1 3/4 " long	\$11.95
41-0034-L	3/4 hose fitting 2 3/4 long	\$11.95



Due to the fluctuation of the Canadian and American dollars call for current prices

Bill's Truck Shop Limited

Phone (905) 725-3460 / (905) 725-2022 / Fax (905) 404-2302 email: bill@billstruckshop.com

Group 41

ENGINE

<u>Part No.</u>		<u>New</u>
36-0704	58-69 Spark Plug Wire Retainer- 4 wire rear small block L & R	\$8.95
36-0083	57-72 Spark Plug Shields-small block V-8-set of 4	\$27.95
36-0795	58-72 Clip-spark plug wires @ oil pan V8 each	\$7.95
36-0703	58-72 Retainer-spark plug wire on block-each	\$3.95
41-03PW-8	58-72 Spark Plug Wire set- V8 small block w point ignition	\$59.95
36-0426	63-77 Spark plug wire set 6 cyl silicone wire w/ point ignition	\$49.95
41-03PW-8	55-72 Spark plug wire set-V8 w/ point ignition	\$59.95
41-025-12LS-P	63-72 Starter SB V8 12V w/ long & short parallel bolts- w/ 12V coil terminal	\$139.95
41-0300	55-75 Starter Solenoid w/ ignition terminal w/ key start	\$69.95
41-0240	55-62 Generator adjust bracket- V8	\$44.95
41-0516	5/16 Neoprene fuel line-----per ft	\$3.49
41-038	3/8 Neoprene fuel hose-----per ft	\$3.49
41-0006	58-62 Fuel pump-235 6 cyl	\$74.95
36-0503	63-74 Fuel Pump 6 cyl 230, 250, 292 CI	\$64.95
Fuel line hose clamps		
36-0561	Hose clamp-spring type 7/16 each	\$0.50
36-0562	Hose clamp-spring type 1/2 each	\$0.55
36-0564	Hose clamp-spring style 5/8 each	\$0.85
36-0695	60-72 Retainer fuel-brake line @ frame double -push in	\$4.95
Breather Wing Nut		
41-0741	Wing nut-carburetor 1/4 - 20	\$0.75
41-0741-10	Wing nut-carburetor 10 x 32	\$1.95



Bill's Truck Shop Limited

Phone (905) 725-3460 / (905) 725-2022 / Fax (905) 404-2302 email: bill@billstruckshop.com

Group 41

ENGINE

<u>Part No.</u>		<u>New</u>
41-02IC-12	Ignition Coil 12V	\$49.95
41-0D-235	53-62 Distributor 235 CI engine/ plus \$30-00 core includes new cap,rotor,points,condensor	\$149.00
18-0203	Ignition Resistor 12 V to 9 V	\$16.95
	Ignition Points w/Condenser	\$38.95
41-03PC	47-62 6 cyl	\$49.95
41-02PC-63	63-74 6 cyl	\$39.95
41-0PC	57-74 V8 uni-set type	\$19.95
	Grommet-distributor wire V8 only	
41-0774	57-74 V8 only	\$3.50
	Dist Cap	
41-02DC-53	53-62 6 cyl dist cap	\$45.95
41-02DC-63	63-74 6 cyl dist cap	\$29.95
41-03DC	57-74 V8 w/ side screws	\$39.95
	Dist Rotor	
41-02DR-53	53-62 6 cyl	\$12.50
41-00DR-63	63-74 6 cyl	\$15.95
41-03DR-57	57-74 V8	\$11.99
19-0131	56-74 Breakerless Ignition system for V8 GM dist- never change point again-uses a Hall Effect magnetic setup	\$245.00
41-0250-D	63-78 230-250-292 6 Cyl HEI distributor will require HEI spark plug wires	\$229.95
36-4146	63-66 Carb kit- 2 bl Rochester	\$24.95
36-0471	<u>63-86 Fuel Filter paper style w/ check valve</u>	\$7.95

41-021C-12



41-0D-235



41-0PC



18-0203



41-02DC-53

41-02DR-53

41-3DC-55



41-0774



36-4146



41-0250-D



36-0471

Bill's Truck Shop Limited

Phone (905) 725-3460 / (905) 725-2022 / Fax (905) 404-2302 email: bill@billstruckshop.com

Group 41

ENGINE

<u>Part No.</u>			<u>New</u>	<u>Used</u>
38-0224	63-84	Thermostat base to head-6 cyl 230-250	\$2.25	
41-0930		Thermostat housing gasket-all 6 & 8 cyl	\$3.95	
38-0786	63-89	Exhaust manifold gasket set- 6 cyl 194/230/250/292 has steel insulator on both sides for better burn away/leakage	\$28.95	
41-0PG-55		Oil pan gasket 235 6 cyl	55-62	\$46.95
41-0842	37-62	Timing cover crank seal 1pc	\$27.95	
38-0131	63-69 230 engine, 66-78 250 engine and 63-89 292 engine.	Valve cover gasket	\$28.95	
31-0228	63 78	230-250 side cover gasket	\$28.95	

Due to the fluctuation of the Canadian and American dollars call for current prices

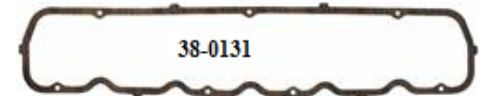
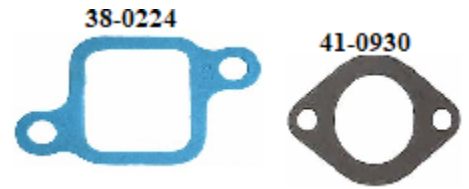

Bill's Truck Shop Limited

Phone (905) 725-3460 / (905) 725-2022 / Fax (905) 404-2302 email: bill@billstruckshop.com

Group 41

ENGINE

<u>Part No.</u>		<u>New</u>	<u>Used</u>
36-0885	64-74 Heat riser-SB w/ 2" pipe 2 3/4 between studs	\$84.95	
36-0350-G	55-85 Heat Riser Gasket SB V8	\$3.95	
41-0381	64-72 Exhaust manifold-6cyl-230/250-292 2 & 3 hole pipe flange/ does not have a heat riser/ outlet angles back	\$325.00	Inquire
38-0786	63-89 Exhaust manifold gasket set- 6 cyl 194/230/250/292 has steel insulator on both sides for better burn away/leakage	\$28.95	
41-0206	47-63 Heat Riser Spring 6 cyl	\$32.95	
36-5350-L	These manifolds can be used on all small block 1963 up 69-72 Exhaust Manifold (LH) 8 cyl C 10 & 20- 2 wheel drive-angle rear dump	\$223.95	
36-5350-R	69-72 Exhaust Manifold (RH) 8 cyl C 10 & 20- 2 wheel drive-angle rear dump	\$223.95	



Due to the fluctuation of the Canadian and American dollars call for current prices

Bill's Truck Shop Limited

Phone (905) 725-3460 / (905) 725-2022 / Fax (905) 404-2302 email: bill@billstruckshop.com

Literature

Group 42

Part No. New Used

ASSEMBLY MANUAL

42-4FAM 60-66 Factory Assembly Manual \$42.95

SHOP MANUAL

Fully illustrated w/ complete information on the repair of your truck. Includes data spec, wiring diagrams, etc **Supplement** requires the previous shop manual

60-60 Shop Manual----- printed for
 42-4SM-60 Chev but also pertains to GMC \$59.95
 42-4SM-61 61-61 Shop Manual Supplement \$17.00
 42-4SM-62 61-62 Shop Manual w/ 4x4 -Supplement \$17.00
 42-4SM-63 63-63 Shop Manual \$59.95
 42-4SM-64 64-64 Shop Manual-Supplement \$19.95
 42-4SM-65 65-65 Shop Manual-Supplement \$39.95
 42-4SM-66 66-66 Shop Manual-Supplement \$29.95

WIRING HARNESS

42-4WH-60 60-60 Wiring Diagram \$9.95
 42-4WH-61 61-61 Wiring Diagram \$9.95
 42-4WH-62 62-62 Wiring Diagram \$9.95
 42-4WH-63 63-63 Wiring Diagram \$9.95
 42-4WH-64 64-64 Wiring Diagram \$9.95
 42-4WH-65 65-65 Wiring Diagram \$9.95
 42-4WH-66 66 Wiring Diagram \$9.95

OWNERS MANUAL

42-460-C 60-60 Chev Owners Manual \$19.95
 42-461-C 61-61 Chev Owners Manual \$19.95
 42-462-C 62-62 Chev Owners Manual \$19.95
 42-463-C 63-63 Chev Owners Manual \$19.95
 42-464-C 64-64 Chev Owners Manual \$19.95
 42-465-C 65-65 Chev Owners Manual \$19.95
 42-466-C 66-66 Chev Owners Manual \$19.95

Accessory Installation Manual Detailed illustrations of all accessories and explains how they are installed. *for passenger cars and trucks*

42-4IM-60 60-60 Accessory Installation Manual \$19.95
 42-4IM-64 64-64 Accessory Installation Manual \$19.95

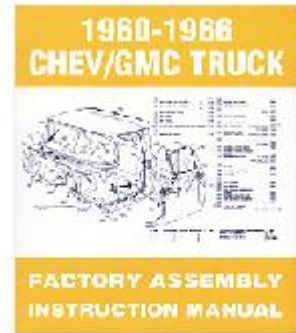

42-4FAM



Bill's Truck Shop Limited

Phone (905) 725-3460 / (905) 725-2022 / Fax (905) 404-2302 email: bill@billstruckshop.com

PERFORMANCE & ACCESSORIES

<u>Part No.</u>		<u>NEW</u>
	Rad Overflow Tank	
44-0255-15	15 " polished stainless steel	\$79.95
44-0PVC	Gas pedal w/chrome vertical bars,rubber insert,spring loaded,adjustable arm & L or R mount	\$89.95
44-0TBS	Bkt w/ return springs-cable-stainless steel	\$23.95
44-0TBS-1	Bkt w/ return springs -cable stainless steel	\$19.95
44-0TBS-2	Throttle cable bkt w/ 350/400 kickdown adapt stainless steel	\$29.95
44-0TC-24	Throttle cable 24 ' long	\$29.95
44-0016	Electric Fan Produces a TRUE 2300 CFM Rating at 18.4 or 14 amp draw. • This fan is 3 1/4" deep through the center of the motor; it gradually thins to 1 1/2" at the outer edge. • Curved blades are quiet and push the same amount of air as a straight blade. • Factory built as a puller, mounted inside and pulls the air through the radiator. • 12V REVERSIBLE 'S' BLADE - Blades & polarity of the wiring can be reversed & it becomes a pusher	\$99.95
44-0014	13.82 " wide 2.58 " deep 1750 CFM 12 V/ 90 W reversible	\$99.95
44-0012	12 " wide 870 CFM 12 V reversible	\$89.95
44-0016-R	Relay-electric fan control This adjustable electric fan switch with thermostat allows you to run your electric fan in a much more efficient manner	\$42.95
44-0016-S	This Electric Fan Relay with Thermostat kit allows you to run your electric cooling fan It powers up your electric fan when your motor reaches -185 degrees F and powers down when your motor reaches 170 degrees F!	\$74.95
44-0016-SD	Dual fan relay Kit, 80 Amps, 12V, temp sender, two 40 Amp relays, On at 195 degrees, Off 180 degrees, Harness, Kit	

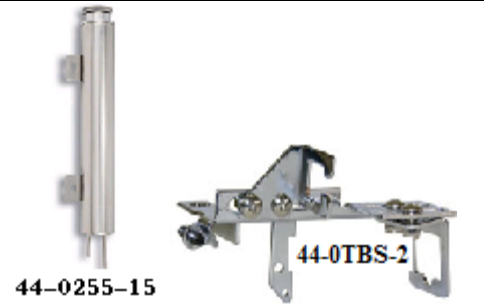

Bill's Truck Shop Limited

Phone (905) 725-3460 / (905) 725-2022 / Fax (905) 404-2302 email: bill@billstruckshop.com

<u>Part No.</u>		<u>New</u>
	Licence Plate Frames-chrome w/ blue details year at top w/ CHEVROLET at bottom each	
44-4L60	60-60	\$14.95
44-4L61	61-61	\$14.95
44-4L62	62-62	\$14.95
44-4L63	63-63	\$14.95
44-4L64	64-64	\$14.95
44-4L65	65-65	\$14.95
44-4L66	66-66	\$14.95

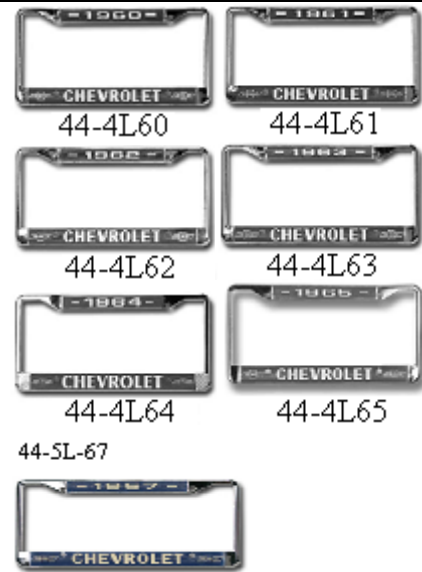

Bill's Truck Shop Limited

Phone (905) 725-3460 / (905) 725-2022 / Fax (905) 404-2302 email: bill@billstruckshop.com

HARDWARE

Group 49

BODY HARDWARE

49-0610	5 /16-18 x 7/8 w/11/16 floating washer-NC	each	\$1.65
49-0612	5/16-18 x 1 w /7/8 floating washer-NC	each	\$2.10
49-0613	5/16 -18 x 3/4 w/ washer head -NC	each	\$1.65
49-0614	3/8-16 x 1 w/ 1 floating washer-NC	each	\$2.95
49-0615	3/8 -16 x1 1/2 w/ 1 1/8 floating washer NC	each	\$3.25

49-0620	5/16 -18 x 3/4 w/ OE style dog point washer head	each	\$0.95
49-0621	5/16 -18 x1 1/16 dog point w/ floating washer-each		\$1.75
49-0622	5/16 -18 x 15/16 dog point w/ floating washer-each		\$1.95

49-0710	5/16 – 18 U – nut	each	\$1.50
---------	-------------------	------	--------

49-0124	1/2 External tooth lock washer -flywheel bolts	each	\$0.30
---------	--	------	--------

BODY ALIGNMENT SHIMS -galvanized steel

20-000D	1/16 w/ 3/8 slot shim	each	\$1.25
20-000E	1/8 w/ 3/8 slot shim	each	\$1.25
20-000K	8 pc Shim kit 4 x 1/16 and 4 x 1/8	set of 8	\$9.95

Totally Stainless bolt kits

Every Body Kit includes component kits-for Front Bumper, Door Hinges, Door Latch & Catch,Fender to Firewall Brace Rods, Front & Inner Fenders,Grill & Gravel Pan, Headlight & Parking Lens, HoodHinges, Hood Latch, Catch & Braces, Interior, Outside Mirror, Radiator Support, and Regulator & Relay.

49-4377	60-66 Chev -Body Bolt kit- 18-8 stainless steel w/ indented hex & Philips bolts-OE style /cab forward does not include bed any bed hdw		\$349.95
---------	--	--	----------



Bill's Truck Shop

Phone (905) 725-3460 / Fax (905) 725-2022 / email: bill@billtruckshop.com

SOLD TO				SHIP TO				
NAME				NAME				
COMPANY				COMPANY				
ADDRESS				ADDRESS				
CITY		PROVINCE		CITY		PROVINCE		
		POSTAL				POSTAL		
HOME PHONE		WORK PHONE		HOME PHONE		WORK PHONE		
YEAR	MAKE	SERIES	BODY STYLE			E-MAIL		
	<input type="checkbox"/> CHEVY <input type="checkbox"/> GMC <input type="checkbox"/> OTHER		<input type="checkbox"/> 1/2 TON <input type="checkbox"/> 3/4 TON <input type="checkbox"/> _____	<input type="checkbox"/> SHORTBED <input type="checkbox"/> LONGBED <input type="checkbox"/> _____	<input type="checkbox"/> STEPSIDE <input type="checkbox"/> FLEETSIDE <input type="checkbox"/> _____			
PART #	DESCRIPTION					QTY	EACH	TOTAL
METHOD OF PAYMENT						SUBTOTAL		
<input type="checkbox"/> E-Transfer <input type="checkbox"/> COD <input type="checkbox"/> VISA <input type="checkbox"/> MASTER CARD								