

FEB 2025 Update

1967 - 1972

Chevrolet & GMC Pickup, Panel, Suburban



1969 - 1972

Blazer & Jimmy

**Now carrying
FORD
pickup parts!**



BILL'S TRUCK SHOP LTD.

CHEV

Est. 1987

GMC

40-90 PARTS & ACCESSORIES

web: www.billstruckshop.com

**Email: aaron@billstruckshop.com, bill@billstruckshop.com, rob@billstruckshop.com,
mike@billstruckshop.com**

Phone: (905) 725-3460, (905) 725-2022

GENERAL INFORMATION

Ordering Information: Please verify part numbers and application upon ordering. On larger orders please email at bill@billstruckshop.com / rob@billstruckshop.com / aaron@billstruckshop.com / mike@billstruckshop.com or call (905) 725-3460, for more information.

Payment: We accept Cash, Debit, VISA, MasterCard, E-Transfers, Company cheques. Applicable taxes apply to all sales.

Shipping: Ship by your choice of Canpar, UPS, FedEx, Purolator, Canada Post, or truck freight Day & Ross on some larger items. Most orders can be shipped same day for next business day delivery. Actual shipping charges will be applied.

Pricing: Prices are in Canadian currency. Due to constant fluctuation between the Canadian and U.S. dollar –refer to the prices in the catalogues as a **GUIDE ONLY!** Bill's Truck Shop Ltd. reserves the right to make appropriate changes as necessary. We try to keep prices low by always keeping a large inventory on hand. WE never buy parts with YOUR money to sell to YOU so we never pre-charge you for normal stocking items that are out of stock.

Returns and Guarantees: If fault is found in the parts or workmanship of item purchased, full money back guarantee or exchange for new item. If fault occurs from installation or misuse, no return will be given. No refunds will be given on electrical components or literature. Call with any questions.

Back Orders: No shipping charges will be applied to regular stocked items, unless a manufacturer's back order applies. All back orders cancelled after 60 days.

Discounts: Business's may apply for discounts after providing valid business info. Regular customer discounts can be applied depending on volume purchases. (E.g.: 5% discount on cash sales - on applicable items only) Check our website for monthly specials.

Parts: There is an ever-increasing supply of reproduction parts, they are not always listed in the catalogues. New items can be viewed on our website, www.billstruckshop.com or call for info.

Hours of Operation: Monday to Friday 8:00am to 5:00pm EST
Saturday 9:00am to 12:00pm EST– Confirm by appointment
Sunday and Holidays – Closed

NOTE: IF DRIVING LONG DISTANCE TO VIEW OUR INVENTORY, PLEASE CALL AHEAD!

Part No.		Price
All bumpers are triple nickel plated before chroming w/rust inhibitor coating on back.		
FRONT BUMPER		
1-507-RL	67-70 Front Bumper - CHEV, chrome - w/ 4" round running lights	\$559.95
1-507-C	67-70 Front Bumper - CHEV, premium quality, chrome	\$359.95
1-507-CS	67-70 Front Bumper - CHEV, SMOOTH, w/o bolt holes, chrome	\$669.95
1-507-P	67-70 Front Bumper - CHEV, painted shipping primer - also fits 67-68 GMC	\$299.95
1-505-C	71-72 Front Bumper - CHEV, chrome	\$379.95
1-505-P	71-72 Front Bumper - CHEV, painted	\$274.95
1-501-C	67-72 Front Bumper - GMC, chrome - has cut out for park lights	\$359.95
1-501-P	67-72 Front Bumper - GMC, painted - has cut out for park lights	\$274.95
FLEETSIDE REAR BUMPERS		
1-510-C	67-72 Rear Bumper - premium chrome - also fits blazer, jimmy, suburban	\$399.95
1-510-P	67-72 Rear Bumper - painted - also fits blazer, jimmy, suburban	\$299.95
1-510-PS & 1-510-CS are smooth rear bumpers w/ hdw, plate box & lights. Does not require the filler plates as the bumper sits close to the body.		
1-510-PS	67-72 Rear Bumper - premium, black - also fits blazer, jimmy, suburban	Inquire
1-510-CS	67-72 Rear Bumper - premium, chrome - also fits blazer, jimmy, suburban	\$649.95
STEPSIDE REAR BUMPERS		
1-0512-C	67-87 Rear Bumper - chrome	\$399.95
1-0512-P	67-87 Rear Bumper - painted	\$274.95
BUMPER GUARDS		
1-550-S	67-68 Bumper Guards - short style, chrome, pair - correct for 67-68 but will also fit 69-72	\$294.95
1-550-T	69-72 Bumper Guards - tall style, w/ rubber impact strip, pair	\$349.95
BUMPER BOLTS		
1-0BBC	47-87 Bumper Bolt - chrome, high dome	\$5.95
1-0BBS	47-87 Bumper Bolt - stainless steel cap, with flat top	\$5.95
1-0BBP	47-87 Bumper Bolt - black, high dome	\$6.50



1-507-RL



1-507-C



1-507-CS



1-507-P



1-505-C



1-501-C



1-510-C



1-510-CS



1-510-PS



1-0512-C



1-0BBS



1-0BBC



1-550-S



1-550-T

Part No.		Price
FRONT BUMPER BRACKETS		
1-520-2WD	67-70 Chev / 67-72 GMC Inner & Outer Brackets, 2WD	\$119.95
1-520-4WD	67-70 Chev / 67-72 GMC Inner & Outer Brackets, 4WD	\$147.95
1-525-2WD	71-72 Chev Inner & Outer Brackets - 2WD	\$119.95
1-525-4WD	71-72 Chev Inner & Outer Brackets - 4WD	\$159.95
1-526	67-72 Chev & GMC Inner Bracket - 2WD & 4WD, each	\$16.95
REAR BUMPER BRACKETS		
<i>- ensure brace to bumper contact area is flat</i>		
1-530-CS	67-72 Rear Bumper Bracket Set - w/ coil rear springs	\$119.95
1-530-CLI	67-72 Rear Bumper Bracket Inner - left	\$38.95
1-530-CRI	67-72 Rear Bumper Bracket Inner - right	\$38.95
<i>71 - 72 Blazer & Suburban use outer brackets only at the center of the frame horn.</i>		
1-530-L	67-72 Rear Bumper Bracket Outer - left	\$38.95
1-530-R	67-72 Rear Bumper Bracket Outer - right	\$38.95
1-530-LS	67-72 Rear Bracket Set - w / leaf rear springs	\$149.95
1-530-LLI	67-72 Rear Bracket Inner - w/ leaf springs, left	\$38.95
1-530-LRI	67-72 Rear Bracket Inner - w/ leaf springs, right	\$38.95
1-0030-4	Bumper Bracket to Frame Bolt Kit - 4 bolts w/ hdw	\$11.95
GRAVEL GAURDS		
1-535-FL	67-72 Fleetside - 19" long, sit on bumper brackets, left	\$24.95
1-535-FR	67-72 Fleetside - 13" long, sit on bumper brackets, right	\$24.95
1-534-PR	67-72 Stepside - 13" long, sit on bumper brackets, pair	\$79.95
1-5137	72-72 Gravel Guards - Blazer & Jimmy, w/ hdw, pair	\$149.95
LICENSE PLATE BRACKET & LIGHTS		
1-0540	67-87 Plate Bracket - all with sport bumper, black	\$59.95
1-0540-C	67-87 Plate Bracket - all with sport bumper, chrome	\$129.95
1-0540-K	67-87 Plate Bracket Bolt kit - w/ license plate hdw, stainless	\$24.95
18-0303-U	59-87 Universal Plate Bracket - all w/o bumper <i>- located under rear cross sill</i>	\$19.95
1-0545	67-87 Plate Light - trucks with sport bumper, w/ hdw	\$36.95
1-0545-L	67-87 Plate Light Lens - each	\$8.95
1-0545-G	67-87 Plate Light Gasket - each	\$2.95
16-0205-12	67-87 Plate Light Bulb - each	\$2.50
1-0545-2	67-87 Plate Light - trucks with step bumper, screw on style	\$15.95
1-0545-3	67-87 Plate Light - trucks with step bumper <i>- inserts in 1-7/16" round hole</i>	\$11.95



Part No.		Price
GMC GRILLES		
2-501-67	67-67 GMC Grille - chrome w/ black letters	\$899.95
2-501-67-P	67-67 GMC Grille - black, paint to match	\$699.95
2-502-68	68-68 GMC Grille - ALL CHROME - OE for 68 - will also fit 69-70	\$799.95
2-502-69	69-70 GMC Grille - Chrome w/ black detail around headlights - will also fit 68 (OE grille for 68 was all chrome w/o black accent)	\$849.95
2-503-71	71-72 GMC Grille Chrome w/ black details	\$824.95
CHEV GRILLE		
2-507	69-70 Chev Grille - without stamped letters	\$799.95
2-507-C	69-70 Chev Grille - with OE style, black painted letters - gm restoration	\$949.95
2-507-GI	69-70 Chev Grille Insert - black with silver details	\$189.95
2-508	71-72 Chev Grille w/ black accent	\$699.95
2-508-GI	71-72 Chev Grille Insert	\$199.95
CHEV GRILLE LETTERS		
2-507-W	69-70 Chev Grille Letters - white	\$5.95
2-507-B	69-70 Chev Grille Letters - black	\$5.95
GRILLE HARDWARE KIT		
2-501-GHK	67-72 GMC Grille Install Hdw Kit	\$15.95
2-502-HBK	67-72 GMC Upper Grille Bar Hdw Kit - 14 screws w/ nuts	\$4.95
2-509-GIK	69-72 Chev Grille Insert Hdw Kit - plastic insert nuts w/ screws	\$22.95
2-509-GHK	69-72 Chev Insert & Surround Hdw Kit - rivets, screws, bolts	\$59.95



2-501-67



2-502-68



2-502-69



2-507



2-507-C

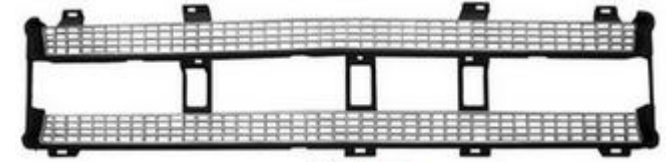

2-507-GI



2-508



2-508-GI

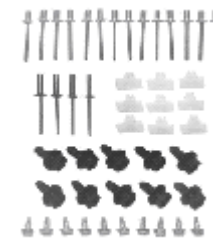

2-509-GHK



2-509-GIK



2-507-B

Part No.		Price
HEADLIGHT BEZELS		
<i>NOTE 67-68 OE headlight bezels did not have light adjust holes & 69-72 did - 69-72 can be used on all years</i>		
2-502-LBL-67	67-68 GMC Headlight Bezel - chrome, w/ hdw, left	Inquire
2-502-LBR-67	67-68 GMC Headlight Bezel - chrome, w/ hdw, right	Inquire
2-502-LBL	69-72 GMC Headlight Bezels - chrome, w/ hdw, left	\$129.95
2-502-LBR	69-72 GMC Headlight Bezel - chrome, w/ hdw, right	\$129.95
2-502-LBRL	69-72 GMC Headlight Bezels - chrome, w/ hdw, pair	\$259.95
2-502-BSK	67-72 GMC Headlight Bezel Screw Kit - w/ j-nuts, 16 pcs.	\$9.95
2-505-LB	67-68 Chev Light Bezels - w/ hdw, aluminium, pair	\$123.95
2-505-BK	67-68 Chev Light Bezel Screw Kit - 8 screws & 8 j-nuts	\$8.95
2-509-LB	69-72 Chev Grille Light Bezels - pair	\$99.95
2-509-BK	69-72 Chev Light Bezel Hdw Kit - both sides, screws & j-nuts	\$11.95
CHEV & GMC MOULDING		
2-501-FML	67-68 Chev & GMC Fender Moulding - w/ hdw, left	\$54.95
2-501-FMR	67-68 Chev & GMC Fender Moulding - w/ hdw, right	\$54.95
2-501-HK	67-68 Fender Moulding Hardware Kit - per side	\$9.45
2-501-HM	67-68 Chev & GMC Hood Moulding - w/ hdw	\$99.95
2-505-GM	67-68 Chev Grille Moulding	\$99.95
2-505-RS	67-68 Chev Grille Moulding Retainer Set - 14 pcs for each moulding	\$29.95
2-505-R	67-68 Chev Grille Moulding Retainer	\$2.00
2-501-GBP	67-68 GMC Upper Grille Bar - painted	\$229.95
2-501-GBC	67-68 GMC Upper Grille Bar - chrome	\$295.95
2-502-FML	69-72 GMC Fender Moulding - chrome, w/ hdw, left	\$136.95
2-502-FMR	69-72 GMC Fender Moulding - chrome, w/ hdw, right	\$136.95
2-502-GB	69-72 GMC Upper Grille Bar - chrome	\$389.95
2-502-FM-T	69-72 GMC Fender Moulding Retainer - upper, w/ hdw	Coming
2-502-FM-M	69-72 GMC Fender Moulding Retainer - middle, w/ hdw	Coming
2-502-FM-L	69-72 GMC Fender Moulding Retainer - lower, w/ hdw	Coming

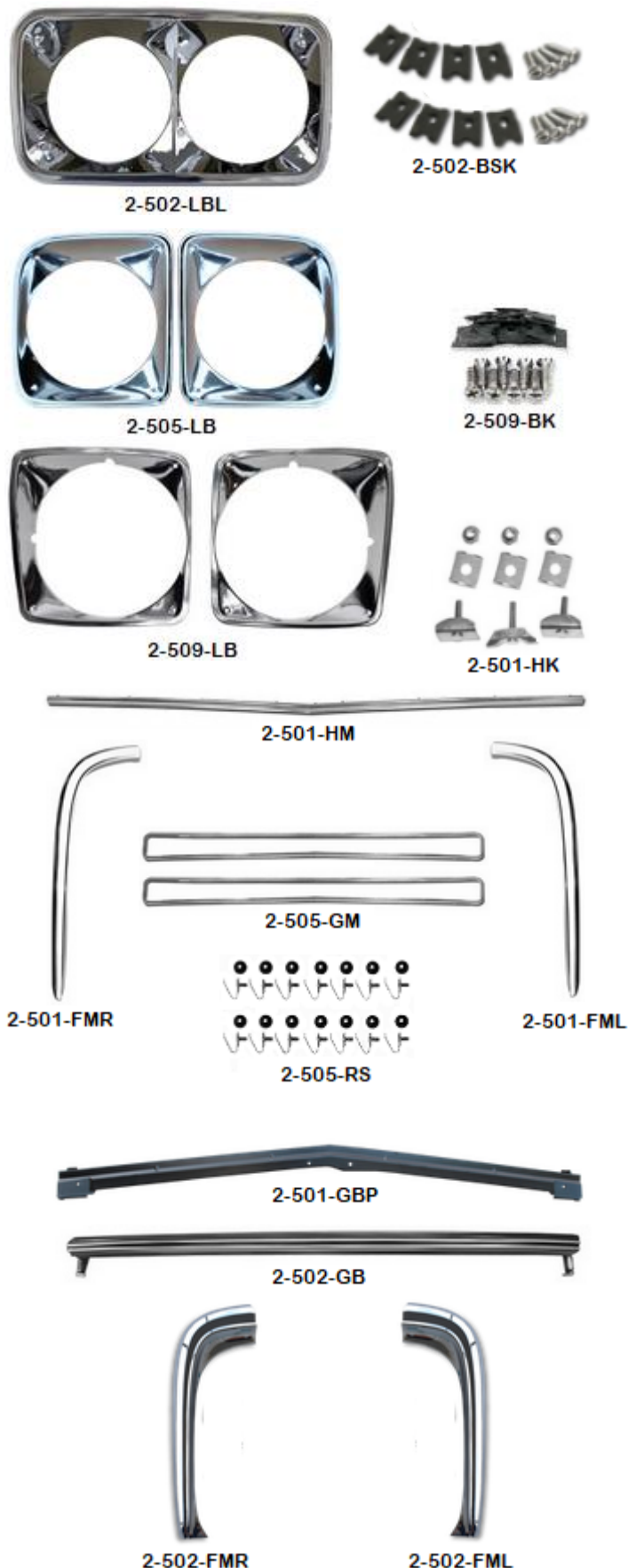

Part No.		Price
CHEV GRILLE SUPPORTS & HOOD LATCHES		
2-505-CGS	67-68 Center Grille Support - Chev	\$49.95
2-505-HL	68-68 Hood Latch - Chev	\$89.95
2-507-CGS	69-70 Center Grille Support - Chev	\$54.95
2-507-CGS-HK	69-70 Center Grille Support Hardware Kit - 9 pcs	\$9.95
2-507-HL	69-70 Hood Latch - Chev	\$89.95
2-508-CGS	71-72 Center Grille Support - Chev	\$46.95
2-508-HL	71-72 Hood Latch - Chev	\$89.95
2-501-CGS	67-68 Center Grille Support - GMC	\$51.95
2-501-HL	67-68 Hood Latch - (offset handle), GMC	\$109.95
2-502-CGS	69-72 Center Grille Support - GMC	\$49.95
2-502-HL	69-72 Hood Latch - (offset handle), GMC	\$109.95
2-509-SGS-L	69-72 Grille Side Support - Chev & GMC, left	\$54.95
2-509-SGS-R	69-72 Grille Side Support - Chev & GMC, right	\$54.95
2-0502-S	67-82 Spring - hood latch safety	\$3.95
3-0220-P	47-54 & 67-74 Hood Latch Pin	\$12.95
3-0220-N	47-54 & 67-74 Hood Latch Pin Lock Nut - w/ washer	\$1.50



Part No.		Price
IDIDIT TILT COLUMNS - includes all levers		
Accepts OE steering wheel, 8 position tilt, knobs & levers - 3-7/8 flat wiring plug, 3/4 x 36 output shaft, without safety start switch. Does not include upper & lower seal w/ retainer MADE IN USA (also available in chrome)		
3-5067-T	67-72 Tilt column w/o shifter - paint as required	Inquire
3-5067-ST	67-72 Tilt column w/ shifter - paint as required	Inquire
3-0010-3	Auto Shift Indicator - with 3 speed auto, acrylic, stock on	\$44.95
3-0010-4	Auto Shift Indicator - with 4 speed auto, acrylic, stick on	\$44.95



3-5067-T

STEERING COLUMNS		
Includes levers, upper & lower seals, and indicators. MADE OFFSHORE - may require signal adaptor harness (19-0878) to fit OE dash harness, 35" from upper housing to end of output shaft		
3-5772-TAR	67-72 Tilt Column - reproduction, auto, black, 3/4 - 36 splined shaft	\$799.95
3-5772-TRB	67-72 Tilt Column - reproduction, w/o shift, black 3/4 - 30 splined shaft	\$759.95



3-5772-TAR

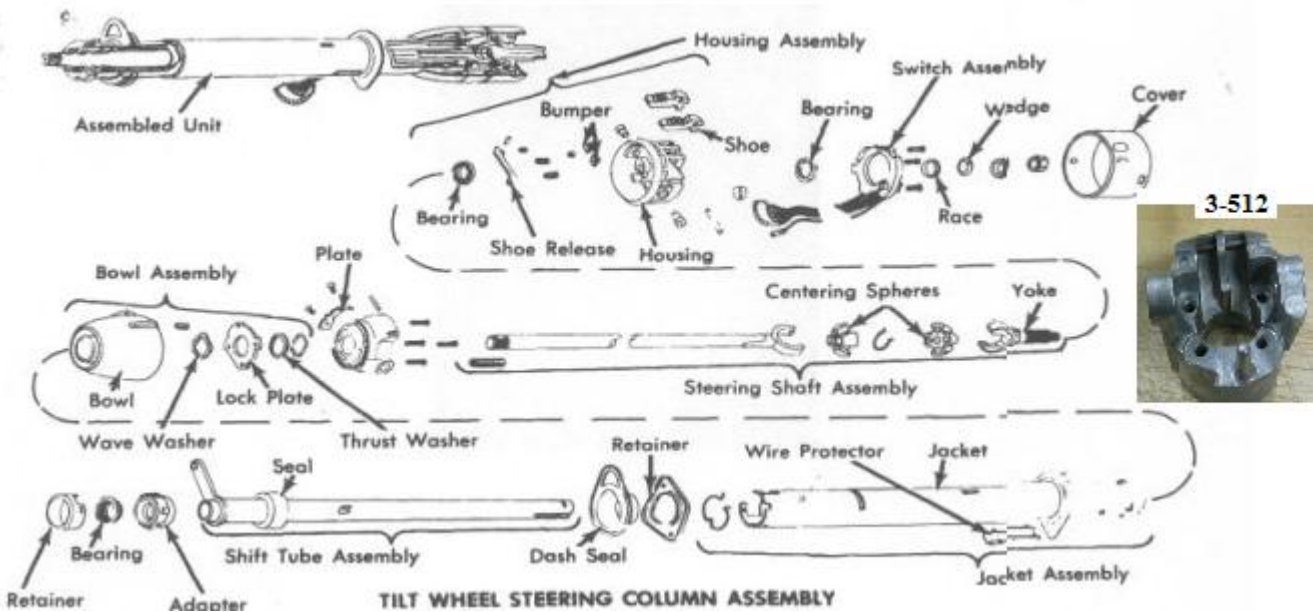

3-512

Part No.		Price
SHIFT LEVERS		
<i>Note - When replacing shift levers (without tilt) check for the nylon bushing at bottom of lever, see #3-502-B. Also check flat side diameter of shift lever - see picture</i>		
3-502-67	67-68 Shift Lever - auto or 3 Speed, w/o tilt	\$38.95
3-502-69	69-70 Shift Lever - auto or 3 Speed, w/o tilt	\$38.95
3-502-71	71-72 Shift Lever - auto or 3 Speed, w/o tilt	\$39.95
3-502-71T	71-72 Shift Lever - auto or 3 speed, w/ tilt	\$39.95
3-502-71-TS	71-72 Shift Lever - auto, w/ tilt - use with smaller diameter wheel	\$37.95
SHIFT LEVER KNOBS		
3-0502-67K	67-91 Shift Handle Knob - black	\$12.95
3-502-71K	71-72 Shift Handle Knob - 3 speed & auto -black plastic	\$13.95
5-0211-F	40-72 Floor Shift Knob - black w/o shift pattern	\$16.95
BILLET ALUMINUM LEVER & KNOB		
3-5308-K	67-72 Tilt & Signal Lever Knob - w/ shifter & 4 way flasher	\$64.95
NP205 4X4 SHIFT KNOB USA MADE		
5-5211-69	69-70 Knob - transfer case 4x4 shift w/ 3/8 NF thread	\$99.95
5-5211-71	71-72 Knob - transfer case 4x4 shift w/ 7/16 NF thread	\$99.95
TURN SIGNAL LEVERS		
3-501-SL	67-72 Signal Lever	\$22.95
3-0501-S	67-77 Signal Lever Screw	\$.50
3-501-TL	69-72 Tilt Lever	\$22.95
COLUMN SHIFT LEVER PARTS		
3-0402-P	60-70 Shift Lever Retainer Pin- tension roll pin style	\$2.25
3-0502-P	73-91 Shift Lever Retainer Pin	\$17.95
3-0541-B	60-78 Shift Rod Bushing - w/auto 3/8" ID - 1/2" OD	\$3.50
3-0541-G	60-76 Shift Rod Grommet - on column, 1/2 ID	\$2.95
3-0542-G	60-76 Transmission Lever Grommets - 3sp std, pair - requires 2 for each arm	\$13.25
3-0502-LS	69-87 Shift Lever Control Spring w/ tilt	\$18.95
3-502-B	67-74 Shift Lever Anti-Rattle Sleeve - nylon, w/o tilt	\$5.95



Part No.		Price
COLUMN SHIFT LEVER PARTS		
3-516-K	67-72 Trans Shift Lever Kit w/ 350 auto / 2 whl drive - includes 3-516-1 / 2 / 3 / 4	\$148.95
3-516-0	67-72 Rotator	\$29.95
3-516-1	67-72 Rod - shift control w/ hdw	\$37.95
3-516-2	67-72 Support - on frame	\$36.95
3-516-3	67-72 Transmission Pivot Lever - w/ spring & clip	\$31.95
3-516-4	67-72 Shift Linkage Grommet - w/ adjuster hdw	\$19.95
BEARINGS		
3-06068-LB	60-68 Lower Column Bearing	\$39.95
3-06068-LB-B	60-68 Lower Column Bushing - replacement style brass	\$19.95
3-06972-LBS	69-87 Lower Column Bearing Support - 69-72 auto w/ tilt, 73-87 auto w/ or w/o tilt	\$14.95
3-06972-C	69-87 Lower Column Bearing Retainer Clip	\$4.95
3-06972-LBR	69-87 Lower Column Bearing Retainer	\$9.95
3-06972-LB	69-72 Lower Column Bearing - w/ collar for non tilt columns - discard collar for tilt columns	\$72.95
3-06972-LBT	69-72 Lower Column Bearing - w/ tilt	\$79.95
3-06972-LS	69-72 Spring - lower bearing collar load	\$9.95
3-6972-UBT	69-72 Upper Column Bearing - w/ tilt	\$44.50
3-06472-UB	64-72 Upper Column Bearing - w/o tilt	\$21.95

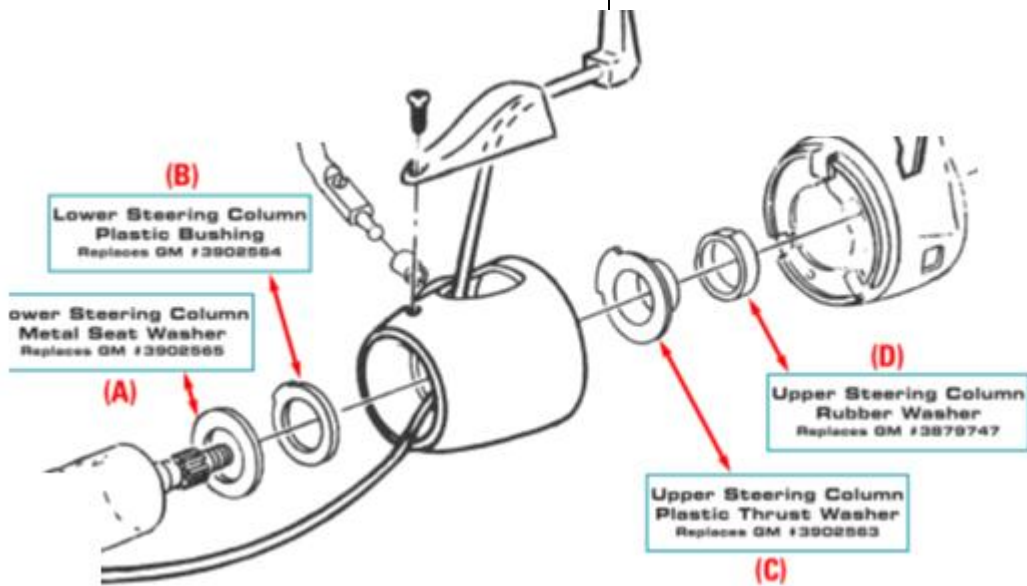

Part No.		Price
STEERING COLUMN CLAMPS & COVERS		
3-512-UC	67-72 Upper Column Clamp - w/ bolts	\$19.95
3-525-U	67-72 Upper Column Seal -each	\$9.95
3-512-LC	67-72 Lower Column Clamp & Support - w/ bolts	\$56.95
3-525-L	67-72 Lower Column Seal -each	\$14.95
3-513-R	67-72 Lower Column Seal Retainer - each	\$24.95
3-512	67-72 Support - auto column w/ tilt	\$79.00
3-513-CC	67-72 Column to Bezel Cover - at seal, w/ hardware	\$19.95
3-513-S	67-72 Column to Bezel Cover Screws	\$1.95
3-511-B	67-72 Shift Lever Housing Bushing - 3 speed std & auto w/o tilt - removes the rocking in shift bowl, 1/4" white nylon	\$8.25
3-511-16S	67-72 Shift Lever Housing Spacer - 16 gauge	Inquire
3-511-21S	67-72 Shift Lever Housing Spacer - 21 gauge	Inquire
3-511-K	67-72 Upper Column Bushing & Spacer Kit - 4 pc - includes rubber cushion steel washer shim, nylon shim & bushing, removes all up and down movement from shift bowl.	\$39.95

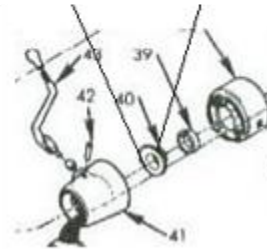
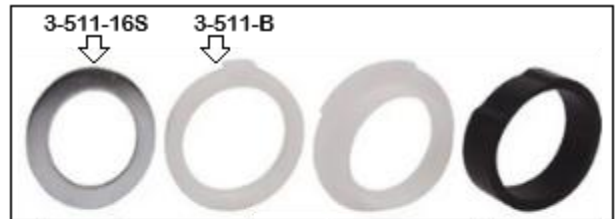

SIGNAL SWITCHES		
Before installing connect signal switches externally to test operation, NO WARRANTY once installed. Switches include 4-way flasher.		
3-503-SS	67-72 Signal Switch - w/ tilt & w/o tilt - correct OE style harness plug, for non-tilt applications remove shift indicator light wire	\$79.95
3-503-SST-B	67-75 Signal Switch - w/ tilt & auto trans - replacement style w/ curved to flat adaptor (19-0878)	\$79.95

STEERING COLUMN ADAPTOR		
19-0878	67-74 Adapts 67-72 curved dash harness to the flat style signal switch dash harness	\$27.95
3-0503-S	67-87 Signal Cancel Springs - pair	\$7.95
3-0503-FB	67-87 4-way Flasher Button - 4 pc kit	\$13.95



Part No.		Price
SWITCHES (continued)		
3-503-SCC	67-72 Signal Lever Cam <i>- replaces the broken cam at signal lever</i>	\$6.60
3-0MRS	60-72 Reverse Light Switch - 3 speed standard on column <i>- please confirm that the column bearings are in good condition. NO warranty on broken switch stud.</i>	\$32.95
3-0417	61-72 Neutral Safety Switch - w/ auto trans, male tab w/ slot	\$17.95
3-0417-S	60-72 Screw Kit - neutral safety & reverse light switch, 2pcs	\$1.95
3-0101	69-77 Kickdown Switch - slide type at gas pedal bracket	\$44.95
FLASHER & HORN RELAY		
18-0213-F12-L2	Signal Flasher - 12-volt, 2 pin (use w/ LED lights)	\$22.50
14-0SF-12	Signal Flasher or 4-Way - 2 pin	\$6.95
14-0SF-12HD	Signal Flasher or 4-Way - HD electric	\$14.95
18-0309-57	67-72 Horn Relay - w/ push on pins	\$42.95
REVERSE LIGHT SWITCH		
19-0578	60-87 Reverse Switch - 4 speed trans, w/ rev lights	\$33.95
IGNITION		
3-530-I	68-72 Ignition Indicator (off-on-start)	\$4.75
3-530-67B	67-67 Ignition Bezel <i>- fits some 68 models, smaller bezel w/o indicator on dash</i>	\$16.95
3-530-68B	68-72 Ignition Bezel	\$12.95
3-530-67S	67-67 Ignition Switch Spacer - between dash & switch	\$19.95
3-530-68S	68-72 Ignition Switch Spacer - between dash & switch	\$8.95
3-530-S	67-72 Ignition Switch	\$28.95
3-530-SP	67-72 Ignition Switch Plug & Wiring - (6")	\$44.95
3-530-67C	67-68 Ignition Cylinder & Keys - old style key	\$27.95
3-530-72C	67-72 Ignition Cylinder & Keys	\$24.95
3-530-68G	68-72 Ignition Key Guard - stainless steel w/ hdw	\$19.95



Part No.		Price
STEERING WHEELS		
3-56768-1	67-68 Steering Wheel - black	\$389.95
OE steering wheels are 17.5" across		
3-56972-1	69-72 Steering Wheel - black	\$389.95
3-56972-2	69-72 Steering Wheel - blue	\$379.95
3-56972-4	69-72 Steering Wheel - green	\$379.95
3-56972-6	69-72 Steering Wheel - saddle	\$379.95
NEW SMALLER 15" OD OE style wheels -accepts all original hdw & cap		
3-56972-1/15	69-72 Steering Wheel - black, 15"	\$399.95
3-56972-2/15	69-72 Steering Wheel - blue, 15"	\$399.95
3-56972-4/15	69-72 Steering Wheel - green, 15"	\$399.95
3-56972-6/15	69-72 Steering Wheel - saddle, 15"	\$399.95
REPLACEMENT STEERING WHEELS		
Classic styled brushed stainless steel 3-spoke steering wheel with black cushioned grip. Includes chrome horn button with Chevrolet Bowtie. 15 inches diameter with 4 1/2" dish.		
5-5625	67-72 Steering Wheel - comfort grip, black - includes mounting hub, horn contact plate & mounting screws	\$359.95
5-5625-P	Horn Contact Plate - for comfort steering wheel	\$36.95
5-5625-H	Hub - steering wheel mounting, 3-15/16" diameter x 1-7/8" tall	\$64.95
5-5625-C	Horn Cap - CHEV, black, red, white details	\$79.95
HORN PARTS		
3-0420-R	60-68 Horn Cap Retainer Rubber	\$9.95
3-0520-60R	60-68 Horn Cap Retainer Cup - 1" high steel retainer	\$16.95
3-0520-60I	60-68 Horn Cap Retainer Insulator - w/ standard wheel, white - approximately 5/15 tall post	\$10.95
3-0520-68I	62-80 Horn Cap Retainer Insulator - red - approximately 3/8 tall post	\$10.95
3-0421-SK	60-68 Horn & Horn Cap Retainer Kit - with standard wheel & white insulator	\$49.95
3-520-69R	69-72 Horn Cap Retainer Cup & Hardware - 3/4 high retainer	\$39.95
3-520-CC	67-72 Horn Contact Ring & Signal Cancel - w/o tilt	\$19.95
3-520-CCT	69-72 Horn Contact Ring & Signal Cancel - w/ tilt	\$19.95
3-520-US	69-72 Spring - upper column under cancel cam	\$6.95
3-0520-HC	64-80 Horn Contact Pin & Spring - w/ lock	\$12.95
5-0230-N	47-72 Steering Wheel Retaining Nut - w/ washer, non tilt only	\$1.95
5-0448	Horn Contact Wire - each - used when updating to later model steering wheel w/ male horn cap connection	\$24.95



3-56768-1



3-56972-1

NEW 69-72 in black, green, saddle & blue.
15" OD wheel instead of the 17.5" OD



3-56972-1/15



5-5625-P



5-5625



5-5625-C



5-5625-H



3-0420-R



3-0520-60R



3-0520-60I



3-0520-68I



3-0421-SK



3-520-CC



3-520-CCT



3-0520-HC



5-0448



5-0230-N

Part No.		Price
HORN CAPS		
3-521-G1	67-68 Horn Cap - GMC	Inquire
3-521-C1	67-68 Horn Cap - Chev, chrome w/ black accent	\$34.95
3-522-C1	69-72 Horn Cap - CHEV, black	\$59.95
3-522-C2	69-72 Horn Cap - CHEV, blue	\$59.95
3-522-C3	69-72 Horn Cap - CHEV, dark blue	\$59.95
3-522-C4	69-72 Horn Cap - CHEV, green	\$59.95
3-522-C6	69-72 Horn Cap - CHEV, saddle	\$59.95
3-522-G1	69-72 Horn Cap - GMC, black w/ red letters	\$59.95
3-522-G2	69-72 Horn Cap - GMC, blue	\$59.95
3-522-G3	69-72 Horn Cap - GMC, dark blue	\$59.95
3-522-G4	69-72 Horn Cap - GMC, green w/ red letters	\$59.95
3-522-G6	69-72 Horn Cap - GMC, saddle w/ red letters	\$59.95
SHIFT INDICATORS		
3-510-67	67-70 Shift Indicator Housing - chrome	\$28.95
3-510-TB	71-72 Shift Indicator Housing - w/ tilt, black	\$11.95
3-510-TC	71-72 Shift Indicator Housing - w/ tilt, chrome	\$11.95
3-510	71-72 Shift Indicator Housing - w/o tilt, black	\$10.50
3-511-67	67-70 Shift Indicator Lens - w/o tilt, w/ 3 speed auto	\$14.95
3-511-PG	67-70 Shift Indicator Lens - w/o tilt, w/ power glide	\$13.95
3-511-T	70-72 Shift Indicator Lens - w/ tilt	\$9.95
3-511-TOD	70-72 Shift Indicator Lens - w/ tilt, w/ 4 speed over drive - TH7004R transmission	\$9.95
3-511	71-72 Shift Indicator Lens - w/o tilt, w/ 3 speed auto	\$12.95
3-512-69	67-70 Shift Indicator Pointer - black	\$16.95
3-512-69L	67-70 Shift Indicator Lens - fibre optic lens	\$7.95
3-512-70T	70-72 Shift Indicator Pointer - w/ tilt	\$8.95
3-512-71	71-72 Shift Indicator Pointer-black	\$13.95
3-515-L	71-72 Shift Indicator Lens - fibre optic	\$7.95
3-515-67	67-70 Fibre Optic Wire - for non-tilt pointer	\$29.95
3-515-71	71-72 Fibre Optic Wire - for non-tilt pointer	\$29.95



Part No.		Price
SHIFT LINKAGE		
3-0TSL-L	47-72 Auto Shift Linkage - stainless steel - column to transmission, 23" long, V8 auto application	\$94.95
40-0804	Trans Shift Kit - 2" column mount, 6' cable w/ hdw & brackets - TH350, TH400, 700-R4, TH200, 200-R4, 4L60 and 4L80E	\$149.95
SHIFTER REPAIR KIT		
41-0137	47-78 Shifter Repair Kit - 4 speed transmission	\$34.95
SPEEDOMETER CABLE		
4-0SCP-3	47-72 Speedometer Cable - plastic casing 60" long	\$59.95
4-0SCP	47-72 Speedometer Cable - plastic casing 70" long	\$22.95
4-0SCS	47-72 Speedometer Cable - steel casing 70" long	\$22.95
4-0SCP-0	47-72 Speedometer Cable - plastic casing 75" long	\$33.95
4-0SCP-1	47-72 Speedometer Cable - plastic casing 85" long	\$56.95
4-0SCP-2	47-72 Speedometer Cable - plastic casing 100" long	\$55.95
SPEEDO DRIVEN GEAR		
1963 - 1987 350 auto, 2 speed power glide & some 3, 4 speed Saginaw transmission speedometer driven gears. Less teeth to increase odometer MPH. More teeth to slow odometer down.		
41-0200	55- 87 Speedo Driven Gear Housing, (bullet)	\$39.95
41-0202	Speedo Drive Gear Retainer - 350, 400, 460	\$8.95
41-0221-18	Speedo Driven Gear - brown, w/ 18 teeth	\$14.95
41-0221-19	Speedo Driven Gear - white, w/ 19 teeth	\$14.95
41-0221-20	Speedo Driven Gear - dark blue, w/ 20 teeth	\$14.95
41-0221-21	Speedo Driven Gear - red, w/ 21 teeth	\$14.95
41-0221-22	Speedo Driven Gear - green, w/ 22 teeth	\$14.95
41-0221-24	Speedo Driven Gear - yellow, w/ 24 teeth	\$14.95
41-0221-25	Speedo Driven Gear - natural, w/ 25 teeth	\$14.95



3-0TSL-L



40-0804



4-0SCS

41-0137

4-0SCP-0



41-0221-18

41-0202

41-0200

41-0221-25

Part No.		Price
HEATER CONTROL ASSEMBLY		
4-502-AC	67-72 Heater Control Assembly - w/ AC	\$279.95
4-501-67	67-68 Heater Control Assembly - w/ switch, black face	\$186.95
4-501-69	69-72 Heater Control Assembly - w/ bright face, includes switch - also replaces 67-68 w/ black face	\$199.95
4-502-S	67-72 Support - control assembly to dash	\$29.95
HEATER CONTROL DECAL		
4-501-67D	67-68 Heater Control Decal - black face	\$6.95
4-501-69D	69-72 Heater Control Decal - bright face	\$6.95
HEATER FAN SWITCHES		
4-0401-FS	67-72 Heater Fan Switch - w/ deluxe heater, w/o AC	\$19.95
4-502-FS	67-72 Heater Fan Switch - w/ AC	\$22.95
4-502-PH	67-72 Heater Fan Switch Plug - w/ AC	\$3.50
HEATER KNOBS & LEVERS		
4-504-BK	67-68 Heater Control Knob - black, set of 3	\$5.25
4-504-C	69-72 Heater Control Knob - chrome, each	\$2.95
4-504-CK	69-72 Heater Control Knob - chrome, set of 4	\$9.95
4-501-D	67-72 Defrost Lever - w/o AC, (top)	\$21.95
4-501-AF	67-72 Air/Fan Lever - w/o AC, controls fan switch, (middle)	\$21.95
4-501-H	67-72 Heat Lever - w/o AC, (lower)	\$21.95
4-567-HK	67-72 Heater Control Lever Kit - stamped levers, w/o A/C - includes knobs, decal	\$49.95
4-502-D-R	67-72 Defrost Lever - w/ AC, w/ hdw, (top) - metal replacement style stamped steel	\$29.95
4-502-K	67-72 Heater Control Lever Set - OE diecast style, w/ A/C	\$48.95
4-502-D	67-72 Defrost Lever - w/ AC, diecast, (upper)	\$21.95
4-502-AH	67-72 Air/Heater Lever - w/ AC, diecast, (middle)	\$21.95
4-502-CH	67-72 Cold/Heat Lever - w/ AC, diecast, (lower)	\$21.95

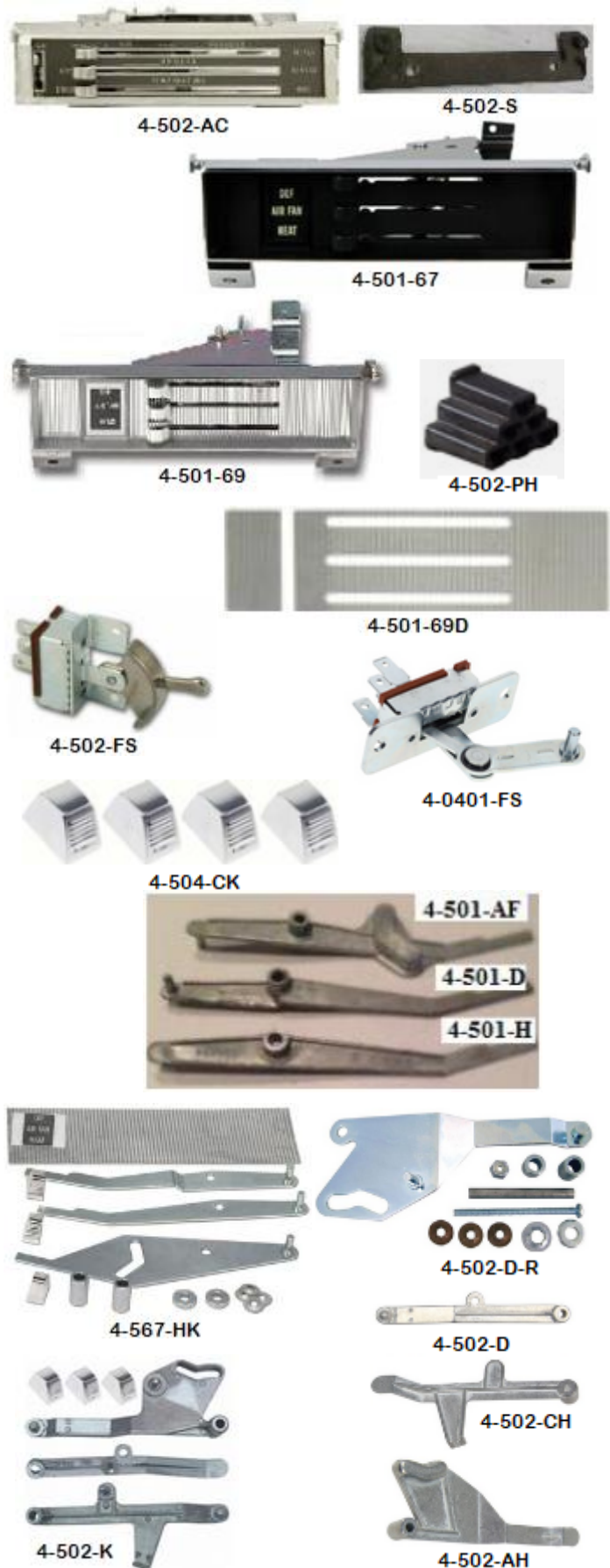

Part No.		Price
HEATER CONTROL CABLES		
4-0085-K	47-87 Heater Cable Retainers - 3 pcs	\$0.95
4-501-HC	67-72 Heater Cable Set - w/o A/C, (with looped ends)	\$36.95
4-502-HC	67-72 Heater Cable Set - w/ A/C, (with looped ends)	\$49.95
4-502-CG	67-72 Cable Grommet - hot & cold cable in firewall at A/C box	\$2.50
HEATER MOTORS		
4-0411-64	64-77 Heater Motor - HD, w/ A/C - with vent tube hole	\$84.95
4-0411-64-F	64-77 Heater Motor - w/o A/C (light duty), w/ plastic blower fan	\$149.95
4-0411-F	60-91 Heater Motor Fan - w/ or w/o A/C, steel, with set screw - use only with HD fan motor, 5-1/4" diameter, 2-5/8" thick	\$42.95
4-0409-MG	60-87 Heater Motor Gasket - all GM car and truck	\$4.20
4-0411-SK	64-72 Heater Motor Screw kit - 6 pcs	\$2.50
4-508	67-72 Blower Motor Housing Seal - each - round rubber seal between heater box and firewall	\$18.95
4-509	67-72 Heater Housing Seal Kit - w/o A/C - includes 4-508 & 4-0409-MG	\$44.95
4-509-AC	67-72 Heater Housing Seal Kit - w/ A/C - includes 4-508 & 4-0409-MG	\$44.95
4-511-GW	67-72 Heater Motor Ground Wire	\$3.00
HEATER CORE		
4-510-C	67-72 Heater Core - w/o A/C, new aluminum	\$99.95
4-510-AC-A	67-72 Heater Core - w/ A/C, new aluminum	\$92.95
4-510-AC	67-72 Heater Core - w/ A/C, new copper	\$169.95
4-509-B	67-72 Heater Box - w/o A/C, (in engine compartment)	\$369.95
4-509-S	67-72 Heater Box Stud - w/ nut	\$13.95



Part No.		Price
HEATER FAN REISTOR & RELAY		
4-0512	60-72 Heater Fan Resistor - w/o AC	\$29.95
4-0512-AC	64-72 Heater Fan Resistor - w/ AC	\$29.95
4-512-ACR	67-72 High Speed Fan Relay - w/ AC	\$39.95
4-513	67-72 AC Compressor Switch - at cold air door in dash	\$69.95
DEFROST DASH OUTLETS		
4-515-CL	67-72 Defrost Outlet - chrome, left	\$17.95
4-515-CR	67-72 Defrost Outlet - chrome, right	\$17.95
4-515-BL	67-72 Defrost Outlet - black, left	\$10.95
4-515-BR	67-72 Defrost Outlet - black, right	\$10.95
4-0517	64-72 Defrost Tubing - w/o A/C, 2pc - original type material	\$59.95
4-0517-P	64-72 Defrost Tubing - w/o A/C, 2 1/2" wide, plastic	\$34.95
4-517-AC	67-72 Defrost AC Tubing - w/ AC, 6 piece set - original type material	\$169.95
A/C DASH OUTLETS		
4-520	67-72 AC / Heat Selector Housing Box	\$179.95
4-521	67-72 Heat < S > Shaped Housing - each	\$49.95
4-523	67-72 A/C Center Dash Diverter - chrome	\$45.95
4-523-G	67-72 A/C Center Outlet Gasket - each	\$7.95
4-523-H	67-72 A/C Center Dash Housing - black, each	\$39.95
4-523-B	67-72 Hardware Kit - A/C center dash outlet, set, w/ lock nuts - correct length studs to secure rear housing to chrome outlet	\$4.95
4-523-B-OE	67-72 Hardware Kit - A/C center dash outlet, set, w/ nuts - OE style studs, secures rear housing to chrome outlet	\$22.95
4-525-CL	67-72 A/C Outlet - chrome, w/ gasket, left	\$32.95
4-525-CR	67-72 A/C Outlet - chrome, w/ gasket, right	\$32.95
4-525-BL	67-72 A/C Outlet - black, w/ gasket, left	\$21.95
4-525-BR	67-72 A/C Outlet - black, w/ gasket, right	\$21.95
4-525-SK	67-72 A/C Lower Outlet Mount Screw Kit - 6 screws, 2 j-nuts	\$4.95
4-525-A	67-72 A/C Outlet Rear Adaptor - (L or R), each	\$25.95
4-525-CB	67-72 A/C Outlet Ball - chrome w/ black accent, each	\$19.95
4-525-G	67-72 A/C Outlet Ball Gasket Set - 4 pcs	\$5.95
4-525-TK	67-72 Template Kit - for installing the 3 factory outlets - this kit cab be rented \$10.00 and returned	\$39.95



Part No.		Price
VENTS		
4-516-V	67-72 Vent - heater box floor	\$17.95
7-505-CV	71-72 Cab Vent Valve - at left door rear post	\$26.95
4-540-V	67-72 AC Valve - at outer cowl	\$79.95
4-540-VP	67-72 Flapper Pivot - w/ nut & sealer	\$12.95
4-540-VG	67-72 Flapper Guide - w/ hardware	\$12.95
KICK PANEL VENTS		
4-560-L	67-72 Vent Valve - at kick panel, w/ rod & handle, left	\$86.95
4-560-R	67-72 Vent Valve - at kick panel, w/ rod & handle, right	\$86.95
4-560-RAC	67-72 Vent Valve - at kick panel, w/ A/C, right	Inquire
7-505-S	67-72 Kick Panel Vent Seal Kit	\$9.95
7-505-H67	67-67 Kick Panel Vent Knob - black, each	Inquire
7-505-H	68-72 Kick Panel Vent Knob - ,round, black, each - will also fit 1967 but not correct square style	\$9.95
ACTUATOR VACUUM		
4-540-VM	67-72 Actuator Vacuum - single port - A/C air valve at outer cowl, stud on arm	\$76.95
4-560-VM	67-72 Actuator Vacuum - A/C vent valve - right side kick panel vent door	\$79.95
4-0540-C	67-74 Vacuum Cannister	\$44.95
A/C BRACKETS - SMALL BLOCK w/ 6 cylinder radial comp		
4-0530-A	66-72 Rear Brace - w/ short neck water pump	Inquire
4-0530-B	66-72 Front Brace - w/ short neck water pump	Inquire
4-0530-C	66-72 Front Adjust Bracket - w/ short neck water pump	Inquire
4-0530-D	66-72 Rear Adjuster Brace - w/ short neck water pump	Inquire
4-0530-E	66-72 Upper Support (cast) - w/ short neck water pump	Inquire
4-0530-F	66-72 Lower Support (cast) - w/ short neck water pump	Inquire

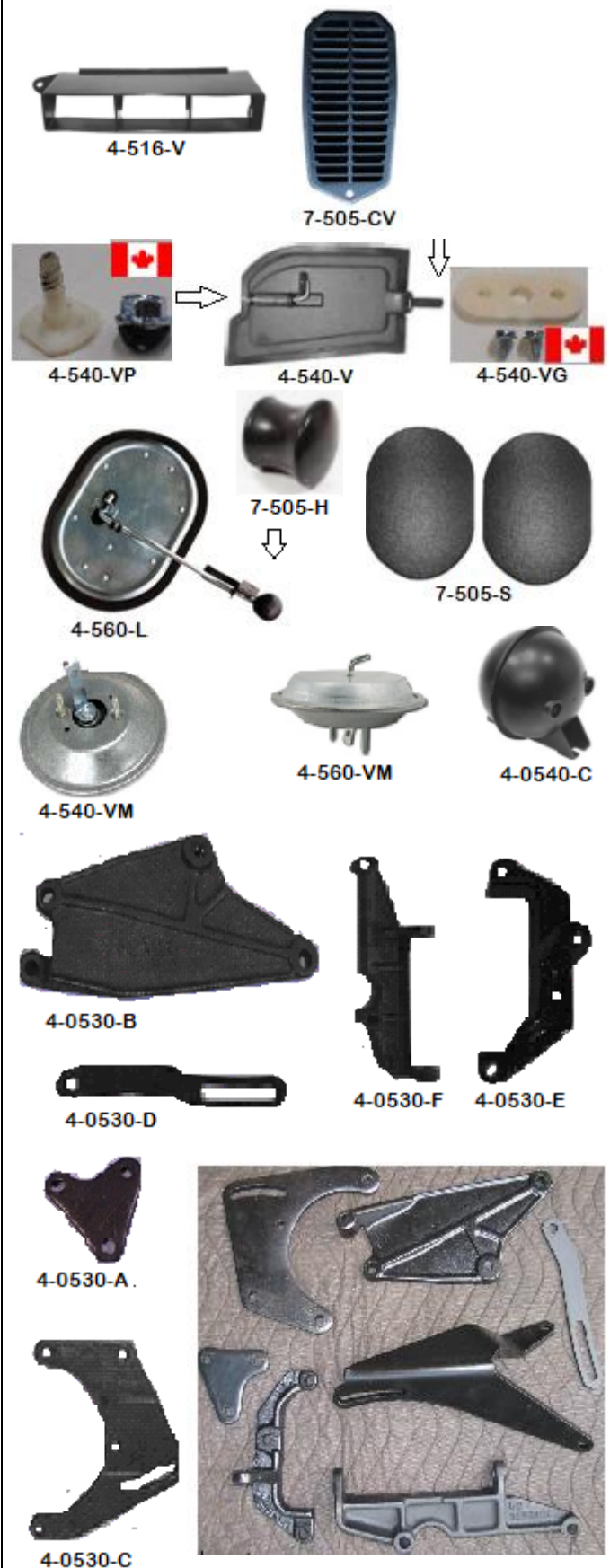

Part No.		Price
A/C HOSE		
4-570-HA	67-72 A/C Hose & Muffler Assembly - w/ R12 charging port	\$124.95
4-570-HA-A	67-72 A/C Hose & Muffler Assembly - w/ R134A charging port	\$124.95
WATER VALVE		
4-571-67	67-69 Water Valve - w/ AC	\$59.95
4-571-70	70-72 Water Valve - w/ AC, (vacuum closes) - fender mount style	\$69.95
4-550-9	67-72 Expansion Valve - w/ straight tube	\$89.95
4-550-10	69-72 Hose - dryer to expansion valve	\$59.95
4-0041	67-72 Vacuum Hose - w/ A/C, 7/64" dia. Sold per foot - for vacuum motors, approx. 20 ft req. (see diagram below)	\$0.95
4-560-VT	67-72 Vacuum "T" - 2 required, w/ A/C trucks, each	\$1.25
4-0551-A	POA Valve Kit - with 134A refrigerant - replacement for the OE system to a cycling clutch system	\$159.95
4-0972-M	Adapter Fitting - AC Line (high pressure) for female switch	\$14.50

Inquire about any interior and exterior original AC parts

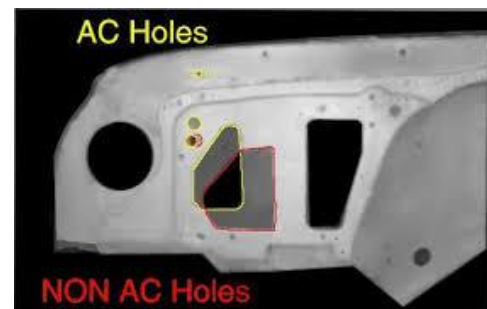
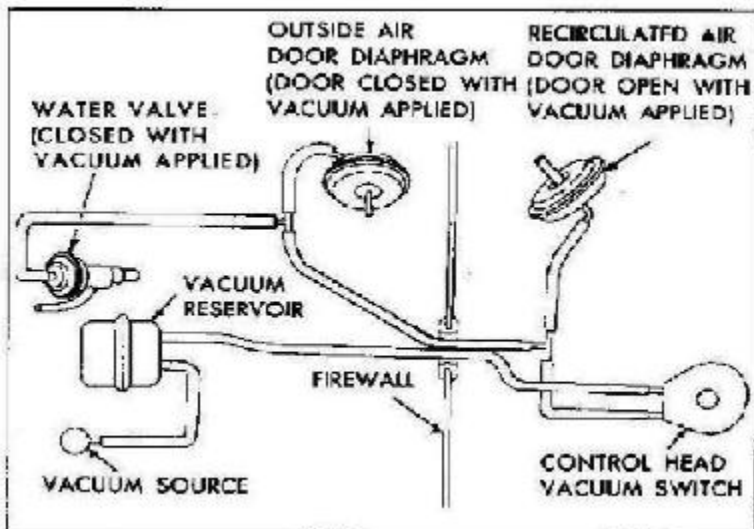

Part No.		Price
A/C CONDENSER		
4-570-C	67-72 Condenser - black powder coated paint	\$349.95
4-570-D	67-72 Receiver Dryer - replacement style	\$85.95
4-570-D-OE	67-72 Receiver Dryer - OE style aluminum	\$118.95
4-572-TK	67-72 A/C Tube Kit - w/ O-rings	\$82.95
4-0550-K	AC O-Ring kit	\$14.95
4-5204	67-72 A/C Evaporator Core	\$425.95
4-5204-H	67-72 A/C Evaporator Spout - case drain hose	\$11.95
10-520	67-72 A/C Line Grommet - 2 hole, under battery tray	\$8.95
10-521-G	67-72 A/C Firewall Grommet - evaporator cable	\$9.95

A/C DEFROST HOSE		
4-0051P	Plastic A/C & Defrost Hose - 6' x 2"	\$34.95
4-0053P	Plastic A/C & Defrost hose - 6' x 2 1/2"	\$34.95
4-0054P	Plastic A/C & Defrost hose - 6' x 2 3/4"	\$34.95
4-0055P	Plastic A/C & Defrost hose - 6' x 3"	\$34.95

OPTIONAL SYSTEM UPGRADES AVAILABLE:
 Chrome Compressor (UG-21-CHR), Polished Compressor (UG-21-POL),
 Trinary Switch Upgrade (UG-24-0103)

4-5211-F	67-72 AC system - R134A refrigerant Hurricane Heat Cool & Defrost Unit- Electronic Slide Control-chrome or black face Mounting brackets / Block-off Plates Duct Hose Adapters ABS Plastic Glove Box Compressor w/ mounting bracket - varies w/ engine A/C Hose Kit Replica Condenser Assembly w/ custom Aluminum Tubes & Factory Style Receiver Drier	Inquire
4-5213-IF	67-72 AC system - same options as above but w/o compressor and brackets	Inquire

Recommended Optional Upgrades

4-5230	67-72 Dual Electric Radiator Fans - w/ shroud	Inquire
4-0103	Trinary Safety Switch Upgrade	Inquire
AC-TOOL	AC line fitting crimping tool kit - loaner available	Inquire



Part No.		Price
INTERIOR & CARGO LIGHT		
5-0DLC-LED	60-72 LED Dome Light - w/ clear lens, LED bulb & harness	\$42.95
5-0DLC-C	60-72 Dome Light Lens - clear	\$11.95
5-0DLC	60-72 Dome Light - w/ chrome housing, w/ bulb	\$17.95
5-0DLW	60-72 Dome Light - w/ white housing, w/ bulb	\$19.95
5-0DLH	60-72 Dome Lamp Harness	\$18.95
5-0DLL	60-72 Dome Lamp Lens	\$4.95
5-0211	60-72 Dome Lamp Bulb	\$3.25

CARGO LIGHT		
5-505-L	67-72 Cargo Light Lens	\$12.95
5-0505-B	67-91 Cargo Light Bulb	\$1.65
5-505-LG	67-72 Cargo Light Lens Gasket	\$2.75
5-505-HS	67-72 Cargo Light Housing Seal - rubber moulded	\$16.95
5-505-MK	67-72 Cargo Light Housing Mount Kit - 4pcs	\$7.95
5-505	67-72 Cargo Light Kit - housing, lens, seal	\$84.95
5-505-S	67-72 Cargo Light Switch - w/ face plate	\$29.95
5-505-W	67-72 Cargo Light Wiring Harness - w/ dome light ext.	\$29.95

DASH ASH TRAY		
5-510-67	67-68 Ash Tray Assembly- single cigarette holder, - sloped rear & thin wall face, nylon slider	Inquire
5-510-69	69-72 Ash Tray Assembly - dual cigarette holder - vertical, rolled face, ball bearing roller	Inquire
5-510-69C	69-72 Ash Tray Assembly - dual cigarette holder, chrome -vertical, rolled face, nylon slider, will also fit 67-68	\$84.95
5-510-69B	69-72 Ash Tray Assembly - dual cigarette holder, black - vertical, rolled face, nylon slider, will also fit 67-68	\$74.95
5-510-B	67-72 Ash Tray Bumpers - correct low profile, pair	\$3.95
5-510-D	67-72 Ash Tray Decal - wood grain	\$7.50

ARMREST ASHTRAY		
9-569-A	69-72 Ashtray - for console armrest, each - fits blazer, suburban, pickup	\$34.95



Part No.		Price
	GLOVE BOX	
5-512	67-72 Glove Box Liner - w/o A/C, w/ inserts & screws	\$32.95
5-512-AC	67-72 Glove Box Liner - w/ A/C, w/ inserts & screws	\$32.95
5-512-S	67-72 Glove Box Screw Kit - 8pcs	\$3.95
5-512-JK	67-72 Glove Box J-Nuts - 8 pcs <i>-required when installing aftermarket plastic glove box liner</i>	\$9.95
5-0GBL	55-72 Glove Box Light Kit	\$19.95
5-0GBB	47-72 Glove Box Bumper Kit - 2 pcs	\$2.50
5-0221	54-72 Glove Box Lock - w/o keys	\$26.95
5-0222	54-72 Glove Box Lock - w/ 2 Keys	\$43.95
5-0224	54-72 Glove Box Lock Retainer - w/ screw	\$3.95
5-0223	54-72 Glove Box Lock Gasket	\$1.50
5-512-LS	67-72 Glove Box Lock Striker - w/ screws	\$8.95
5-513-C	67-72 Glove Box Door - chrome	\$239.95
5-513-69	67-72 Glove Box Door - black , w/ hinge & arm	\$158.95
5-514-H	67-72 Glove Box Door Hinge	\$34.95
5-514-AI	69-72 Aluminium Insert - for glove box door w/ Woodgrain	\$99.95
5-514-DW	69-72 Glove Box Door Woodgrain Decal - for dlx insert	\$12.00
5-514-SW	67-72 Glove Box Door Woodgrain Decal - for standard door	\$24.95
5-513-B	67-67 Glove Box Door Arm Bumper - sleeve type	\$1.95
5-513-67A	67-67 Glove Box Door Arm - hooked end	Inquire
5-514-B	68-72 Glove Box Door Arm Bumper - round button type	\$3.25
5-514-68A	69-72 Glove Box Door Arm	Inquire
5-512-D	67-72 Glove Box Decal - option list	\$21.95



Part No.		Price
RADIOS		
5-521-D	67-72 Radio Woodgrain Decal	\$5.95
<p><i>Custom Autosound's USA-230 have been designed to fit in the stock dash without any modifications required. Providing an auxiliary input which can connect to iPods, iPhones, satellite radio tuners or any other device with a headphone jack. Electronic shafts and digital clock. It also boasts 4 Channel RCA pre-outs and a digital display with electronic tuner, 16 station pre-sets and a 4-way fade.</i></p>		
5-5TKL-2	67-72 Radio AM/FM - 12V , 200 watts, w/ chrome bezel, Chev - CHEV logo	\$299.95
5-5TKL-2G	67-72 Radio AM/FM - 12V , 200 watts, w/ chrome bezel, GMC - GMC logo	\$299.95
<p><i>The USA-740 has all the features of the USA 230 but comes with built-in Bluetooth (microphone included), answer calls and get Bluetooth streaming music from your Bluetooth capable phone or Bluetooth compatible device. Match the color of your instrument cluster with user selectable multiple LCD color choices with LCD dimmer control. The AM/FM RDS tuner shows station, song and artist on the LCD display.</i></p>		
5-5TKL-7	67-72 Radio AM/FM - USA 740, 12V , 300 watts, w/ chrome bezel - CHEV logo, Bluetooth	\$499.95
5-5TKL-S	67-72 Radio AM/FM - Chev & GMC, slide bar - Call for info	\$499.95
67 & 68-72 Radio Knobs - see wiper knob #6-503-68K		
6-503-68K	68-72 Wiper Knob - black w/ stainless center - "D" shaft like radio, secures w/ set screw	\$14.95
5-0HAN	Amplified Electronic AM/FM Hidden Antenna -requires 12v includes 80" cable, peel & stick application	\$49.95
Great for under seat or rear parcel shelf speaker kit.		
5-0UC2	Universal Speaker Kit - 200 watts, 11"W x 12.5"D x 3"H, pair - 8" sub woofer & 2 Piezo tweeters in each box	\$259.95
RADIO HARNESS		
5-0525-RH	61-72 Radio Power Wire	\$26.95
5-0525-SH	64-72 Speaker Harness	\$28.95
RADIO DELETE PLATE		
6-5388-DP	67-72 Radio Delete Plate - w/ clips - 2-1/2"H x 8"W	Inquire



5-521-D



5-5TKL-2



5-5TKL-7



5-5TKL-S



6-503-68K



5-0HAN



5-0UC2



5-0525-RH

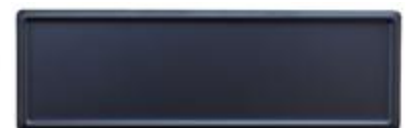

6-5388-DP

Part No.		Price
SPEAKERS		
5-520-KP	67-72 Kick Panel Speaker Set - Molded plastic. - 6.5 triaxial speakers w/ 80 watts	\$199.95
5-520-B	67-72 Kick Panels w/o Speakers - install your own	\$139.95
Installing the dual voice speaker requires using the original firewall support bracket to secure to firewall. Part # 5-520-S		
5-520-DV-AC	67-72 Dual Voice Cone Dash Speaker - w/ A/C, w/ hdw - 140 watt	\$89.95
5-520-DVC	67-72 Dual Voice Cone Dash Speaker - w/o A/C, w/ hdw - 140 watt	\$99.95
ANTENNA		
5-526-TA	67-72 Antenna Kit - telescopic, w/ cable & hardware	\$124.95
5-526-M	67-72 Antenna Mast - telescopic mast	\$26.95
5-527-SM	67-72 Antenna Kit - solid mast, w/ cable & hardware	\$99.95
5-527-M	67-72 Antenna Mast - solid mast	\$22.95
5-526-C	67-72 Antenna Cap / Nut - for solid mast antenna	\$19.95
5-0526-G	67-72 Antenna Gasket - for solid mast antenna	\$1.95
5-526-N	67-72 Nut - antenna mast	\$14.95
5-0426-G	60-72 Grommet - antenna cable	\$1.95
CIGARETTE LIGHTER		
5-510-L	67-72 Cigarette Lighter Assembly - w/ harness	\$34.95
5-510-DP	67-72 Cigarette Lighter Delete Plug - OE used item	Inquire

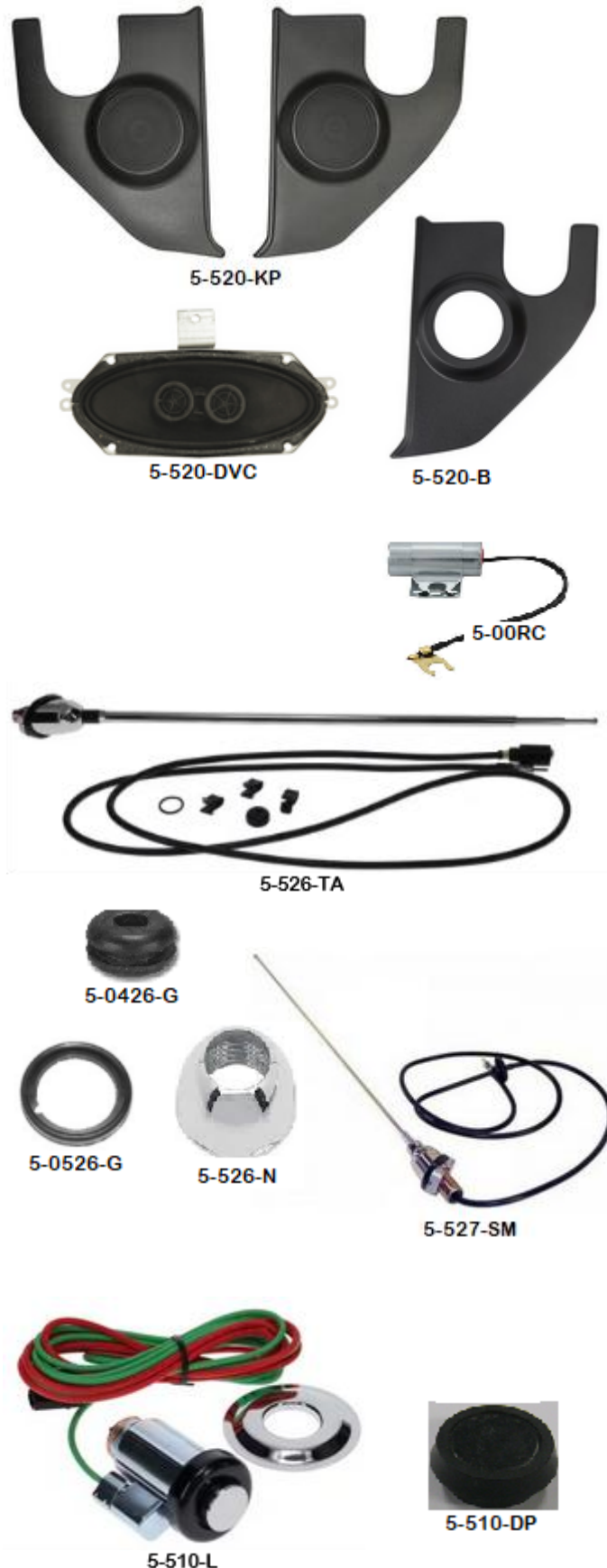

Part No.		Price
DASH BEZELS		
5-530-67BG	67-68 Dash Bezel - black, w/ chrome edges, w/ gauges	\$89.95
5-530-67CG	67-68 Dash Bezel - all chrome, w/ gauges	\$69.95
5-530-67BL	67-68 Dash Bezel - black, w/ chrome edges. w/ lights	Inquire
5-530-69WGG	69-72 Dash Bezel - wood grain, w/ chrome edges, w/ gauges	\$109.95
5-530-69BG	69-72 Dash Bezel - black, w/ chrome edges, w/ gauges	\$89.95
5-530-69CG	69-72 Dash Bezel - all chrome, w/ gauges	\$83.95
5-530-69BL	69-72 Dash Bezel - black, w/ chrome edges, w/ lights (3 hole)	\$79.95
5-530-69CL	69-72 Dash Bezel - all chrome, w/ lights (3 hole)	\$69.95
DASH BEZEL WOODGRAIN		
5-530-67WG	67-68 Dash Bezel Woodgrain Appliqué - w/ gauges	\$15.50
5-530-69WG	69-72 Dash Bezel Woodgrain Appliqué - w/ gauges	\$24.95
5-530-67WL	67-68 Dash Bezel Woodgrain Appliqué - w/o gauges	\$15.50
5-530-69WL	69-72 Dash Bezel Woodgrain Appliqué - w/o gauges	\$15.50
DASH BULBS & HOUSINGS		
5-530-SH	67-72 Signal Indicator Housing - paper, w/ green lens, each	\$6.95
5-530-HH	67-72 High Beam Housing - paper, w/ red lens, each	\$6.95
19-0194	72-87 Bulb - clear, push in, dash & side lights, each	\$0.95
5-0535	67-80 Dash Bulb Socket - w/ bulb, each	\$4.95
5-530-SKB	67-72 Dash Bezel Screw Kit - black, 6 pcs	\$2.95
5-530-SKS	67-72 Dash Bezel Screw Kit - stainless steel, 6 pcs	\$3.95
5-530-SKJ	67-72 Dash Bezels J-nuts - clips on dash for screws, 6 pcs	\$5.95
INSTRUMENT CLUSTER LENS		
5-530-LL	67-72 Instrument Cluster Lens - w/ lights	\$65.95
5-530-LG	67-72 Instrument Cluster Lens - w/ gauges	\$65.95
5-530-LTG	67-72 Instrument Cluster Lens - w/ tach, gauges, w/o vac - lens tach to 5000 RPM	\$69.95
5-530-LTVG	67-72 Instrument Cluster Lens - w/ tach, gauges, w/ vac - lens tach to 5000 RPM	\$69.95
5-530-LB	67-72 Instrument Lens Bumpers - 6 pcs	\$3.95



5-530-67BG



5-530-67CG



5-530-69WGG



5-0535



5-530-HH



5-530-69BL



5-530-SH



5-530-LB



5-530-SKJ



5-530-SKB



5-530-LL



5-530-LG



5-530-LTVG

Part No.		Price
PRINTED CIRCUIT		
5-530-CL	67-72 Printed Circuit - w/ lights	\$79.95
5-530-CG	67-72 Printed Circuit - w/ gauges, w/o tach	\$84.95
5-530-CTG	67-72 Printed Circuit - w/ gauges, w/ tach	\$84.95



DASH CLUSTER		
Most gauge cluster are special order, please confirm pricing. Assemblies are complete with all bulbs. Please call for current pricing.		
5-567-G	67-68 Dash Cluster - w/ gauges, w/ black & chrome bezel	Inquire
5-567-TG	67-68 Dash Cluster - w/ gauges, w/ black & chrome bezel - with 5000 RPM tach, lens, printed circuit, harness	Inquire
5-567-TG-5C	67-68 Dash Cluster - w/ gauges, w/ black & chrome bezel - with 5000 RPM tach, lens, printed circuit, harness & clock	Inquire
5-567-TG-8	67-68 Dash Cluster - w/ gauges, w/ black & chrome bezel - 8000 RPM tach, lens, printed circuit, harness	Inquire
5-567-TG-8C	67-68 Dash Cluster - w/ gauges, w/ black & chrome bezel - 8000 RPM tach, lens, printed circuit, harness & clock	Inquire
5-567-TGV	67-68 Dash Cluster - w/ gauges, w/ black & chrome bezel - 5000 RPM tach, vac, lens, printed circuit, harness	Inquire
5-567-TGV-8	67-68 Dash Cluster - w/ gauges, w/ black & chrome bezel - 8000 RPM tach, vac, lens, printed circuit, harness	Inquire
5-569-G	69-72 Dash Cluster - w/ gauges, w/ black & chrome bezel	Inquire
5-569-TG	69-72 Dash Cluster - w/ gauges, w/ black & chrome bezel - 5000 RPM tach, lens, printed circuit, harness	Inquire
5-569-TG-5C	69-72 Dash Cluster - w/ gauges, w/ black & chrome bezel - 5000 RPM tach, lens, printed circuit, harness & clock	Inquire
5-569-TG-8	69-72 Dash Cluster - w/ gauges w/ black & chrome bezel - 8000 RPM tach, lens, printed circuit, harness	Inquire
5-569-TG-8C	69-72 Dash Cluster - w /gauges w/ black & chrome bezel - 8000 RPM tach, lens, printed circuit, harness	Inquire
5-569-TGV	69-72 Dash Cluster - w/ gauges, w/ black & chrome bezel - 5000 RPM tach, vac, lens, printed circuit, harness	Inquire
5-569-TGV-8	69-72 Dash Cluster - w/ gauges, w/ black & chrome bezel - 8000 RPM tach, vac, lens, printed circuit, harness	Inquire



NO WARRANTY ON GAUGES IF INSTALLED INCORRECTLY

Part No. Price

NO WARRANTY ON GAUGES IF INSTALLED INCORRECTLY

CLOCK CONVERSION

Clock replaces vacuum gauge.

Fits clusters with gauges and tachometer only. Front and back gauge housings

5-530-CK 67-72 Clock Conversion Kit - includes clock, harness, lens \$449.95

DASH TACH KIT

5-567-TK 67-72 Dash Tach Kit - 5000 RPM tach \$469.95

- includes lens, printed circuit, harness, & tach housing

5-567-TK-8 67-72 Dash Tach Kit - 8000 RPM tach \$499.95

- includes lens, printed circuit, harness, & tach housing

5-567-TKV 67-72 Dash Tach Kit - 5000 RPM tach, vac \$549.95

- includes lens, printed circuit, harness, & tach housing

5-567-TKV-8 67-72 Dash Tach Kit - 8000 RPM tach, vac \$579.95

- includes lens, printed circuit, harness, & tach housing

5-567-TC 67-72 Dash Tach Kit - 5000 RPM tach, CLOCK \$524.95

- includes custom lens, printed circuit, harness, & tach housing

5-567-TC-8 67-72 Dash Tach Kit - 8000 RPM tach, CLOCK \$549.95

- includes custom lens, printed circuit, harness, & tach housing

DASH TACH

No returns on tachometers when installing in a non tachometer dash cluster

5-530-DT 67-72 Dash Tach - 8-cylinder engine only \$199.95

5-530-TH 67-72 Dash Tach Harness - w/ ignition points & coil \$34.95

5-530-TH-HEI 67-72 Dash Tach Harness - w/ HEI distributor \$37.95

DASH GAUGES

5-530-A 67-72 Amp Gauge \$69.95

5-530-F 67-72 Fuel Gauge \$72.95

5-530-S 67-72 Speedometer Gauge \$169.95

5-530-T 67-72 Temp Gauge \$74.95

5-530-V 67-72 Vacuum Gauge \$109.95

5-530-O 67-72 Oil Pressure Gauge \$114.95

5-0LK 47-72 Oil Line Kit - 5 ft copper tube w/ fittings \$32.95

5-0682 Block Fitting - oil line \$3.50



5-530-CK



5-567-TK



5-530-DT



5-530-TH



5-530-A



5-530-F



5-530-S



5-530-T



5-530-V



5-530-O



5-0LK



5-0682

Part No.		Price
BRAKE LIGHT SWITCH		
3-0BS	60-87 Brake Light Switch - w/ nuts	\$9.95
HEADLIGHT SWITCH		
3-0HS	64-72 Headlight Switch	\$29.95
6-501-67	67-68 Headlight Knob & Rod - black, w/ stainless center - smaller knob	\$19.95
6-501-69	69-72 Headlight Knob & Rod - black, w/ stainless center	\$18.95
6-501-B	67-72 Switch Retainer Bezel - wiper / light / choke cable etc.	\$11.95
3-5HS-N	67-72 Headlight Switch Inner Retainer Nut - each	\$10.95
6-0522	67-72 Headlight Switch Ground Washer - each	\$0.50
DIMMER SWITCH		
3-0DS-P	60-82 Dimmer Switch Plug Connector w/ hwd	\$7.95
3-0DS	62-83 Dimmer Switch	\$12.95
3-0DS-HK	62-83 Dimmer Switch Hardware - 4pcs	\$0.95
WIPER SWITCH		
6-503-67	67-67 Wiper Switch - has 5/8 long stem	\$69.95
6-503-68	68-72 Wiper Switch - has 5/16 long stem	\$44.95
6-0523	67-72 Wiper Switch Ground Washer - 1/2 ID	\$0.50
6-0922	67-72 Wiper Switch Nut - each	\$2.25
6-503-68K	68-72 Wiper Knob - black, w/ stainless center	\$14.95
WIPER MOTOR		
WIPER PARTS - \$40.00 core deposit.		
When installing motors will require 2 mount grommets #6-0405-G, all wiper motors will include 6-0505-S & 6-0347		
The Clean Wiper Drive 6-505-A is a new bolt-in replacement for your O.E.M. electric windshield wiper motor. Kit includes all the necessary hardware to install the wiper drive in the factory mounting brackets. Designed for attachment to OE wiper transmission		
6-505-A	67-72 Wiper Motor - (add 21-0211-U for washer pump) - Requires shaft extension to use stock windshield switch knob.	\$424.95
21-0200	47-72 Pulse Wiper Control - 3 speed w/ washer - accepts 5-304-B bezel	\$149.95
6-0505-4	63-72 Wiper Motor - w/ 4 pins, requires 2 mount grommets - requires 2 mount grommets 6-0405-G	\$189.95



Part No.		Price
WIPER MOTOR GASKET / GROMMET		
6-0405-G	63-87 Grommet - wiper motor mount, w/ screw	\$8.95
6-0405-S	60-72 Wiper Screw – correct screw w/ washer	\$2.95
6-0505-S	64-72 Wiper Motor Shaft Seal - rubber	\$9.95
6-0347	64-72 Wiper Motor Body Gasket - each	\$6.95
WASHER PUMP		
21-0211-U	Trico Electric Washer Pump - universal	\$39.95
6-0505-K	Washer pump rebuild kit	\$15.95
6-0505-WP	64-72 Washer Pump Assembly	\$79.95
WASHER JAR		
6-0506-K	60-74 Washer Jar - w/ hose, cap & filter	\$29.95
6-0506-C	60-72 Washer Jar Cap	\$9.95
6-0506-F	60-72 Washer Jar Filter - each	\$5.95
6-0406-B	60-69 Washer Jar Support Bracket - w/ hardware	\$24.95
6-506-B	69-72 Washer Jar Support Bracket - w/ hardware	\$20.95
6-0406-HK	60-72 Washer Jar Bracket Hardware - 3 pcs	\$2.00
WIPER TRANSMISSION		
6-507-A	67-72 Wiper Transmission Linkage Arm - w/ clip	\$9.95
7-0451-R	66-72 Wiper Transmission Linkage Clip - each	\$7.95
6-507-PR	67-72 Wiper Transmission Set - w/ motor arm	\$199.95
6-0602-SK	60-72 Wiper Transmission Screw Kit - 8ps	\$2.95
WIPER ARM & NOZZLES		
6-508	67-72 Wiper Arm - left or right, stainless steel, each	\$25.95
6-508-B	67-72 Wiper Blades - 15" stainless steel, each	\$22.95
6-505-HK	67-72 Washer Hose Kit - 5/32 and 7/32 hose - correct "thin wall" hose at firewall or fender mount	\$49.95
6-505-W	67-72 Washer Nozzles - pair, w/ hardware - lock locator tab holes must be drilled for 67-68	\$19.95

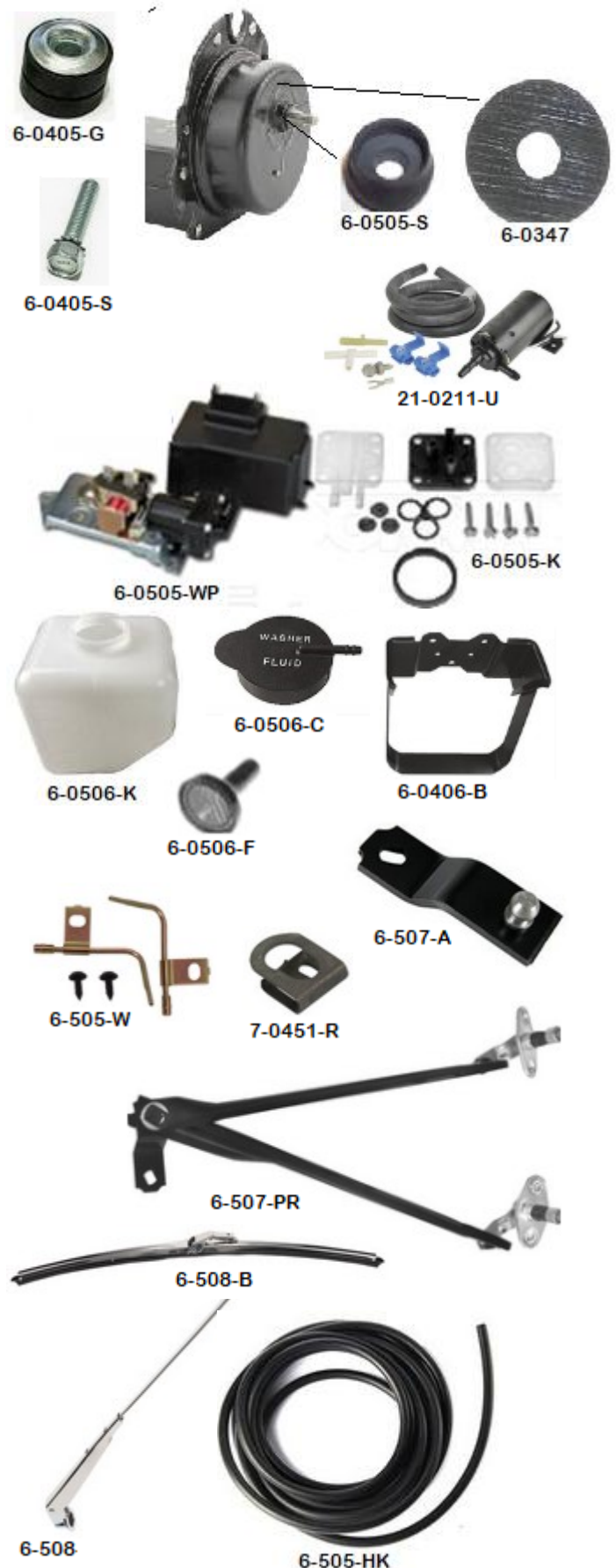

Part No.		Price
PICKUP FUEL TANKS & PARTS		
All tanks must be installed w/ OE style mount plates when securing to cab		
6-510-67	67-71 Fuel Tank - w/ out emission pipe, w/ 2" neck	\$399.95
6-510-72	70-72 Fuel Tank - w/ emission vent pipe	\$399.95
6-510-M	67-72 Fuel Tank Mount Plate - w/ bolt, each	\$5.95
6-510-MK	67-72 Fuel Tank Mount Plate Kit - 7 plates, w/ bolts	\$39.95
14-0GTP	49-66 Fuel Tank Insulator Kit	\$9.95
REAR MOUNT GAS TANKS		
67-72 Suburban & 69-72 Blazer replacement style gas tanks. These tanks can be installed behind the rear ends of all pickup trucks		
6-510-K	67-72 Fuel Tank Relocation Kit - w/ short side fill pipe - includes straps & 90 ohm sending unit, 20 US gallons	\$399.95
6-510-BK	67-72 Fuel Tank Relocation Kit - w/ bed floor top fill pipe - includes straps & 90 ohm sending unit, 17 US gallons Add #14-0FCC cool cap, 14-00FH fill hose	\$399.95
6-0510-PTK	63-72 Fuel tank - w/ bed floor fill top fill - steel, low profile, baffles in tank, fuel injection compatible with external pump, accepts aftermarket fuel senders, 20-gal, w/ hdw	\$649.95
14-0FCC	Cool Cap - flush mount, screw cap w/ 1 1/2" fill neck, 3" flange - billet aluminium, non venting	\$99.95
14-00FH	Fuel Hose - neoprene, 4" long x 1 1/2" ID, w/ clamps	\$16.95
6-50GD	67-72 Gas Fill Delete Plate - weld in	\$22.95
SUBURBAN & PANEL		
6-510-SPNL	67-72 Suburban & Panel - 20-gal, w/ short side fill pipe - tank only, fuel sender and hardware not included	\$299.95
BLAZER / JIMMY GAS TANK		
6-510-BJ	69-72 Gas Tank - original style - w/ long over frame fill neck pipe - 20 gallon, includes straps, sending unit	\$449.95
6-510	69-72 Gas Tank - original style, w/ long over frame neck - 20-gallon tank ONLY	\$349.95
6-510-IK	68-72 Gas Fill Kit - Install fuel fill in bed side light location - Includes, hose, pipe, fill neck and light hinge	\$189.95
6-510-KS	67-72 Gas Tank Strap Set - blazer, jimmy	\$32.95
6-510-DK	67-72 Fuel Tank Insulator Kit - blazer, jimmy, suburban	\$9.95



6-510-67



6-510-K

16" wide body
19" wide at stamped edge
26" long body
29 1/2" long at stamped edge
11" high

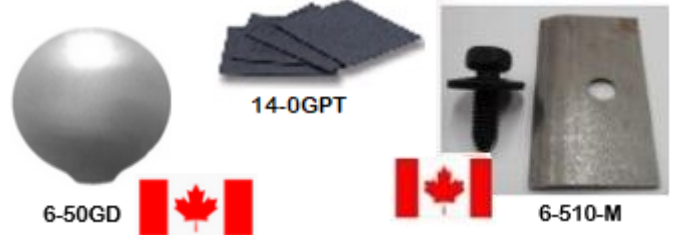

6-50GD

14-0GPT

6-510-M



14-00FH



6-510-BK



14-0FCC



6-510-BJ



6-510-BJ

Part No.		Price
FUEL SENDERS		
<i>Confirm fuel sender with existing sender before ordering. Fuel senders are 0 to 90 ohm and have push on wire pin.</i>		
6-511-FS6	67-71 Fuel Sender - 6 cylinder & 5/16 line & screw on fitting - with O-ring	\$59.95
6-511-FS8	67-71 Fuel Sender - 8 cylinder & 3/8 line & screw on fitting - with O-ring	\$59.95
6-511-FSS	72-72 Fuel Sender - with standard transmission, single line - 3/8 flared end to accept hose, with O-ring	\$59.95
6-511-FSA	72-72 Fuel Sender - with automatic transmission, double line - 3/8 flared ends to accept hose, with O-ring	\$59.95
6-511-SB	67-72 Fuel Sender - blazer, suburban, w/ O-ring - 0-90 ohms, with O-ring	\$59.95
6-511-BKS	67-72 Fuel Sender - blazer, suburban (bed fill tank only) - 0-90 ohms, with O-ring	\$59.95
14-0204-30	Fuel Sender - universal, 30-ohm, adjustable to tank size	\$64.95
14-0204-90	Fuel Sender - universal, 90-ohm, adjustable to tank size	\$64.95
6-0204-S	54-71 Fuel Sender Pickup Screen - OE metal type for 5/16line	\$28.95
6-0204-S3/8	71-86 Fuel Sender Pickup Screen - OE metal type for 3/8 line	\$28.95
6-511-S	67-72 Fuel Sender O-ring - rubber	\$2.00
6-511-SR	67-72 Fuel Sender Lock Ring - each	\$2.95
6-0204	47-72 Fuel Sender Float - brass	\$11.95
GAS CAPS		
6-0GCS	47-70 Gas Cap - stainless steel	\$15.95
14-0416	47-70 Gas Cap - chrome, lock type, w/ bowtie cover	\$55.95
14-0417	47-70 Gas Cap - chrome, lock type, smooth w/ 2keys	\$22.95
6-57172-S	71-78 Gas Cap - stainless steel	\$15.95
6-57172-L	71-72 Gas Cap - chrome, lock type, w/ red info decal	\$36.95
FUEL NECK GROMMETS		
10-570-2GM	67-70 Fuel Neck Seal - w/ 2" fuel inlet pipe, pick-up, USA made - also fits 69-72 Blazer / Jimmy	\$18.95
10-570-2	67-70 Fuel Neck Seal w/ 2" fuel inlet pipe, pick-up - also fits 69-72 Blazer / Jimmy	\$8.95
10-570-1	71-72 Fuel Neck Seal - w/ 1 1/2 fuel pipe	\$8.95
10-570-1GM	71-72 Fuel Neck Seal - w/ 1 1/2 fuel pipe, USA made	\$16.95



Part No.		Price
PARK BRAKE		
6-525-H	69-72 Park Brake Release Handle - black	\$8.95
6-525-HC	69-72 Park Brake Release Handle - chrome	\$9.95
6-520-C	67-68 Park Brake Handle Cover - black	\$42.95
FIREWALL INSULATION PAD		
Original style w / die-cut holes		
7-501-67L	67-68 Firewall Insulation Pad - left	\$34.95
7-501-69L	69-72 Firewall Insulation Pad - left	\$39.95
7-501-67C	67-70 Firewall Insulation Pad - center	\$49.95
7-501-71C	71-72 Firewall Insulation Pad - center	\$49.95
7-501-67R	67-72 Firewall Insulation Pad - w/o A/C, right	\$24.95
7-501-K	67-72 Firewall Fasteners - replacement plastic type, 9 pcs - holes will require reaming a little larger to install	\$12.95
7-501-RR	67-72 Firewall Fasteners - original rubber type, USA made, each	\$4.95
PEDALS, PADS, TRIM		
Deluxe pads accept trim only		
7-0510-S	60-72 Brake / Clutch Pad - standard waffle pattern, each	\$5.95
7-510-D	67-72 Brake / Clutch Pad - deluxe, each	\$5.95
7-510-T	67-72 Brake / Clutch Pad Trim - deluxe, stainless steel, each	\$10.95
7-511-S	69-72 Park Brake Pad - standard waffle pattern	\$5.95
7-511-D	69-72 Park Brake Pad - deluxe	\$6.95
7-511-T	69-72 Park Brake Pad Trim - deluxe, stainless steel	\$5.95
7-514-S	67-70 Gas Pedal Pad - standard, w/ rod operation	\$18.95
7-514-D	67-70 Gas Pedal Pad - deluxe, w/ rod operation	\$19.95
7-514-T	67-70 Gas Pedal Pad Trim - deluxe, stainless steel	\$23.95
7-0GPS	60-70 Gas Pedal Studs - pair	\$17.95
7-514-B	68-70 Gas Pedal Bumper - on firewall, w/ screw	\$6.95
7-515-P	71-72 Gas Pedal Pad - w/ cable operation	\$6.95
7-515-T	71-72 Gas Pedal Pad Trim - stainless steel	\$9.95
7-0515-S	71-75 Gas Pedal Pad Spring - pivot spring	\$9.95
7-0515-PP	71-75 Gas Pedal Pad Pin - pivot pin	\$7.95
7-515-HK	71-72 Bolt kit - hardware to secure base to firewall, 3 bolts	\$1.50



Part No.		Price
ACCELERATOR TRANS CABLE & LINKAGE		
7-0517	55-70 Accelerator Rod - pedal to cab, 6 or 8 cylinder, 15" - comes with swivel and cotter pins	\$34.95
7-0517-S	55-70 Accelerator Rod Swivel - each	\$5.95
7-0014	60-71 Accelerator Rod Bushing - each	\$6.95
7-518-C	71-72 Throttle Cabe - C10/20, 350 & 402, 21 1/2" long - spring clip end to stud at carb	\$44.95
7-518-K	71-72 Throttle Cable - K10/20 - 8 cylinder, 18" long - spring clip end to stud at carb	\$44.95
7-0518-R	71-75 Throttle Cable Retainer - at pedal arm in cab	\$3.95
7-0007	Throttle Return Spring Set - inner & outer	\$9.95
7-5670	67-70 Accelerator Pedal Linkage Kit - at firewall	\$124.95
7-5172	71-72 Accelerator Pedal Linkage Kit - at firewall - includes bracket for auto kickdown switch (part # 3-0101)	\$149.95
THROTTLE CABLE (UNIVERSAL)		
44-0TC-24	Throttle Cable - 24" long	\$29.95
44-0TC-24-SS	Throttle Cable - 24" long	\$49.95
THROTTLE CABLE BRACKET		
44-0TBS	Throttle Cable Bracket - w/ return springs, stainless steel	\$24.95
44-0TBS-1	Throttle Cable Bracket - w/ return springs	\$19.95
44-0TBS-2	Throttle Cable Bracket - w/ 350, 400 kickdown, stainless steel	\$29.95
41-0026-SB	Universal Auto Kick Down Bracket - SB, w/ 350 trans	\$19.95
GAS PEDAL		
44-0PVC	Gas Pedal - w/ chrome vertical bars, rubber insert - spring loaded, adjustable arm, left or right mount	\$89.95
DETENT CABLE		
41-0955	69-87 Detent Cable - Universal, 250, 250C, 350, 350C auto	\$48.95
CHOKE CABLE		
5-0002	Universal Choke, Throttle, Heater Cable - 66" long - cables install through retainer	\$23.95
5-550-K	67-68 Choke Cable Knob - deluxe, twists on cable end	\$14.95



Part No.		Price
FLOOR SHIFTER BOOTS		
7-520-4CK	68-72 4 Speed Shift Boot - w/ 6 & 8 cylinder, 4x4 - also fits 6cyl C/K10/20, SM465 Muncie transmissions	\$42.95
7-0520-RS	68-72 4 Speed Shift Boot Retainer - C/K10/20, steel - 6 5/8" x 8"	\$19.95
7-0520-RSS	68-72 4 Speed Shift Boot Retainer - C/K10/20, stainless steel - 6 5/8" x 8"	\$29.95
7-0520-RSOE	68-72 4 Speed Shift Boot Retainer - C/K10/20, steel, black - OE style	\$22.95
7-520-8	68-72 4 Speed Shift Boot - angled front, 8 cyl C10 & 20 - located close to firewall at front of trans floor pan	\$32.95
7-520-S	67-72 Floor Shifter Seal - floor to trans, w/ 4 speed trans	\$15.95
7-522-6	67-67 4 Speed Shift Boot - w/ 6 cyl, C/K10/20, - round flat, with round shifter rod hole	\$34.95
7-522-RSS	67-67 4 Speed Boot Retainer - w/ 6 cyl, C/K10/20 stainless - round flat, with round shifter rod hole, w/ hdw, 6 1/2" x 6 1/2"	\$29.95
7-521	69-72 Transfer Case Shifter Boot - K5/10/20	\$42.95
7-521-RS	69-72 Transfer Case Shifter Boot Retainer - K5/10/20 - steel, paint to match, w/ hardware, 7" x 5 3/4"	\$21.95
7-521-RSS	69-72 Transfer Case Shifter Boot Retainer - K5/10/20, - brushed stainless steel, w/ hardware, 7" x 5 3/4"	\$29.95



7-520-4CK



7-0520-RS



7-0520-RSOE



7-520-8



7-520-S



7-522-6



7-522-RSS



7-521



7-521-RSS



BILL'S TRUCK SHOP LTD.

CHEV

Est. 1987

GMC

40-90 PARTS & ACCESSORIES

PICTURE COMING SOON

Part No.		Price
CARPETS		
Carpets include jute backing, heel pad, dimmer switch ring, moulded to fit with sewn edges and no pre-cut holes up to the gas tank. Originally a loop style but can be ordered cutpile.		
Carpet must be ordered HIGH HUMP (removable trans cover) or LOW HUMP floor.		
HH = high hump floor LH = low hump floor		
A wide selection of colours is available to order on a non-returnable special order basis. Please visit accmats.com to identify the colour code desired.		
Pickup		
8-500-LH1	67-72 Pickup Carpet - LH floor, black	\$299.95
8-500-HH1	67-72 Pickup Carpet - HH floor, black	\$299.95
8-500-LH4	67-72 Pickup Carpet - LH floor, dark green	\$299.95
8-500-HH4	67-72 Pickup Carpet - HH floor, dark green	\$299.95
8-500-LH5	67-72 Pickup Carpet - LH floor, red	\$299.95
8-500-HH5	67-72 Pickup Carpet - HH floor, red	\$299.95
8-500-LH09	67-72 Pickup Carpet - LH floor, medium blue	\$299.95
8-500-HH09	67-72 Pickup Carpet - HH floor, medium blue	\$299.95
8-500-LH18	67-72 Pickup Carpet - LH floor, dark blue	\$289.95
8-500-HH18	67-72 Pickup Carpet - HH floor, dark blue	\$289.95
8-500-LH35	67-72 Pickup Carpet - LH floor, dark olive green	\$299.95
8-500-HH35	67-72 Pickup Carpet - HH floor, dark olive green	\$299.95
Blazer / Jimmy		
Rear cargo area carpet is shorter on sides while the CST option has side panels		
8-501-LH1	69-72 Blazer Carpet - black - low hump, to inner bed wall - complete front & rear, w/ wheel tubs, high hump trans floor	\$689.95
8-501-HH1	69-72 Blazer Carpet - black - high hump, to inner bed wall - complete front & rear, w/ wheel tubs, low hump trans floor	\$749.95
8-501-FHH1	69-72 Blazer Carpet - front only, 4x4	\$299.95
8-501-R1	69-72 Blazer Rear Carpet - w/o CST option - black	Inquire
8-501-R1-C	69-72 Blazer Rear Carpet - w/ CST option - black	Inquire
SUBURBAN		
8-502	67-72 Suburban Carpet - complete front & rear, w/ wheel tubs	Inquire
8-502-F	67-72 Suburban Carpet - front section only	Inquire
8-502-R1	67-72 Suburban Carpet - rear cargo area	Inquire



Cutpile



Loop

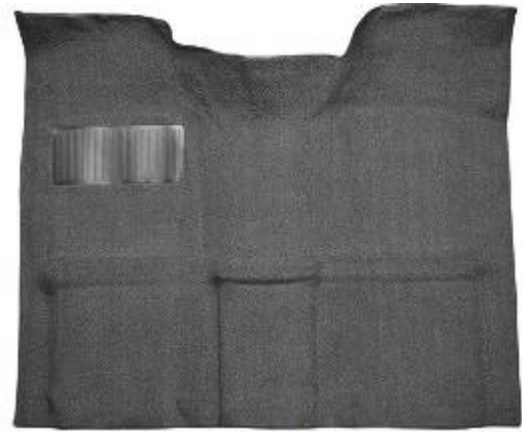

PICKUP

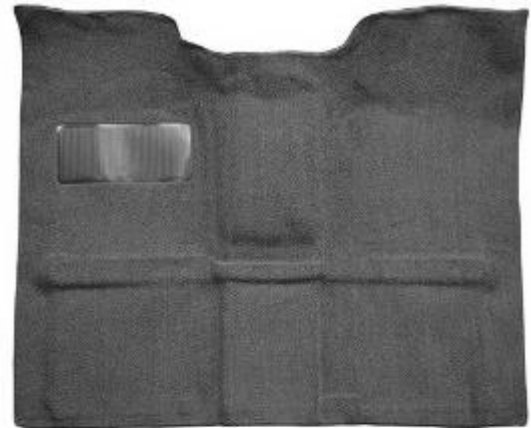

BLAZER

Part No.		Price
FLOOR MATS		
<i>Inquire about different colours available, with or without logos</i>		
8-515-FMCL	67-72 Floor Mats - w/ lock, non skid, black w/ red bowtie, pair	\$169.95
8-515-FM	67-72 Floor Mats - w/ lock, non skid, black, pair	\$129.95
8-505-LH	67-72 Rubber Floor Mat - low hump floor, black - to seat with side extensions	\$289.95
8-505-HH	67-72 Rubber Floor Mat - high hump floor, black - to seat with side extension	\$289.95
INSULATION PAD		
8-505-PAD	67-72 Insulation Pad - die cut felt for low hump floor	\$69.95
8-505-PAD-HH	67-72 Insulation Pad - die cut felt for high hump floor	\$74.95
8-505-S	67-72 Insulation Pad - die cut felt, under seat area	\$59.95
8-508-LH	67-72 Floor Deadener Kit- OE style die cut, low hump floor - asphalt based material, w /foam back to reduce noise & heat	\$99.95
8-508-HH	67-72 Floor Deadener Kit- OE style die cut, high hump floor - asphalt based material, w /foam back to reduce noise & heat	\$33.95
11-0HSD	Universal Heat & Sound Insulation - 4 x 6 - 3 /8 single sided foil backed, with jute liner	\$47.95
STEP PLATES		
8-510-C	67-72 Step Plates - chrome, w/o bowtie, w/ hdw, each	\$33.95
8-510-CB	67-72 Step Plates - chrome, w/ bowtie, w/ hdw, each	\$43.95
8-510-SS	67-72 Step Plates - stainless steel, w/o bowtie, w/ hdw, each	\$39.95
8-510-SSB	67-72 Step Plates - stainless steel, w/ bowtie, w/ hdw, each	\$49.95
8-510-CS	67-72 Step Plate - Suburban , 3 rd door, chrome, w/ hdw, each	\$29.95
8-510-SK	67-72 Step Plate Screw Kit - stainless steel, 8 pcs	\$2.50
8-0130	60-87 Threshold Plates - stainless steel, pair - 2 3/4" W x 27" L, urethane or screw onto outer rocker panel	\$59.95
BLAZER & JIMMY SILL PLATES		
8-569-FS	69-72 Sill Plate - front of floor, stainless steel, w/ hdw	\$289.95
8-569-RS	69-72 Sill Plate - rear of floor, stainless steel, w/ hdw	\$324.95



8-505-LH



8-505-PAD



8-515-FM



11-0HSD



8-510-C



8-510-SS

8-510-CS



8-510-SK



8-569-FS

8-569-RS



Part No.		Price
<p>A wide selection of colours is available to order on a non-returnable special order basis. Please visit accmats.com to identify the colour code desired.</p>		
KICK PANEL CARPET		
8-500-KP	67-72 Kick Panel Carpet Set - see colours available	
8-500-KP1	67-72 Kick Panel Carpet Set - black, pair	\$99.95
8-500-KP2	67-72 Kick Panel Carpet Set - medium blue, pair	\$99.95
8-500-KP3	67-72 Kick Panel Carpet Set - brown, pair	\$99.95
DOOR CARPET		
8-500-D	67-72 Lower Door Carpet Set - see colours available	
8-500-D1	67-72 Lower Door Carpet Set - black, pair	\$94.95
8-500-D2	67-72 Lower Door Carpet set - medium blue, pair	\$94.95
KICK PANEL COVER		
8-512	67-72 Kick Panel Cover - plastic moulded, paint to match, pair	\$89.95
GAS TANK COVER		
8-500-GT	67-72 Gas Tank Cover - carpet - see colours available	\$159.95
8-500-GT1	67-72 Gas Tank Cover - carpet, black	\$159.95
8-515-GT	67-72 Gas Tank Cover - cardboard, die-cut	\$69.95
BENCH SEATS		
8-5768	67-68 Bench Seat - rear folds ahead, w/o track	Inquire
8-5970	69-70 Bench Seat - w/o track - has scroll on seat cover up middle of each person	Inquire
8-5172	71-72 Bench Seat - w/o track - has scroll on seat cover around each person	Inquire
SIDE SEAT SPRING		
8-5700-RS	67-72 Seat Side Spring - at rear, left or right side, each	\$14.95
8-5700-FS	67-72 Seat Side Spring - at front left or right side, each	\$14.95
8-5701-SR	67-72 Seat Base Spring - front to rear for passenger side - can be used on driver side with modification (flat top)	\$29.95

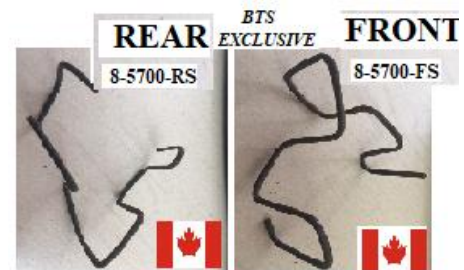
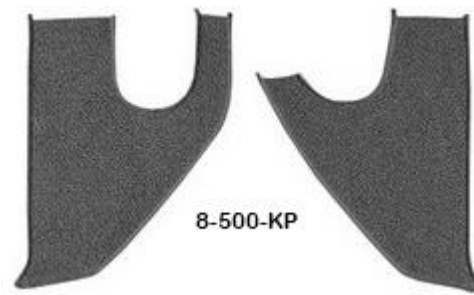

Part No.		Price
BENCH SEAT TRACKS		
8-5768-T	67-68 Bench Seat Track - pair	\$259.95
8-5970-T	69-70 Bench Seat Track - pair	\$259.95
8-5172-T	71-72 Bench Seat Track - pair	\$269.95
8-5205-B	67-72 Seat Track Hardware - track to seat or floor, 8 pcs	\$9.95

SEAT TRACK HARDWARE

Adjust bars (8-570-LB-L, 8-570-LB-R) fit 67-72 bench seat and 69-72 bucket seat tracks.
Each lock bar includes 8-570-A.

8-570-A	67-72 Seat Adjuster Lock Spring - w/ retainer, per side	\$9.95
8-570-LB-L	67-72 Seat Adjust Lock Bar - left side, each	\$17.95
8-570-LB-R	67-72 Seat Adjust Lock Bar - right side, each	\$17.95
8-0070	50-87 Seat Adjust Cable Kit - w/ adjustable turnbuckle	\$12.95
8-0570-K	67-72 Seat Knob - black	\$14.95
8-570-S	68-72 Seat Arm To Base Screws - w/ washers, pair	\$3.95

SEAT RETURN SPRING

11-0307-S	55-80 Seat Return Spring - each	\$11.95
8-570-HS	67-72 Seat Adjust Handle Return - each	\$9.95
11-0209	55-72 Tie clip - seat spring, set of 3	\$2.95

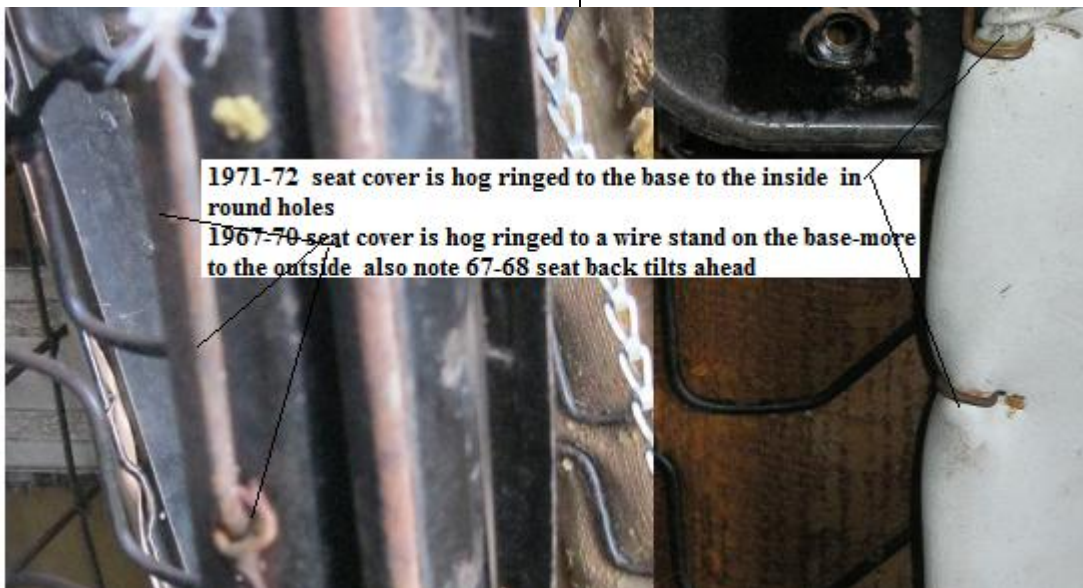
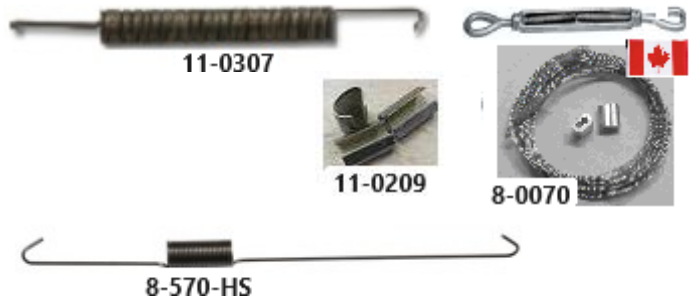
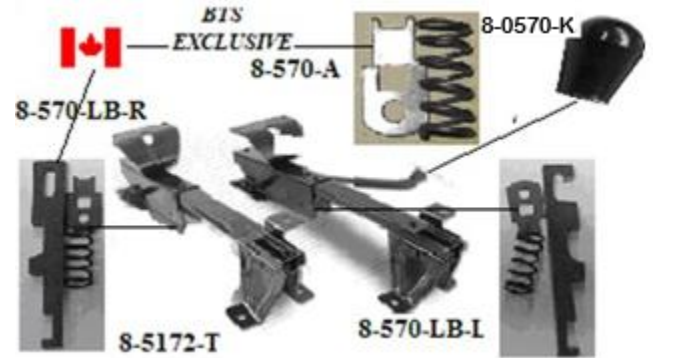

Part No.		Price
SEAT COVERS		
<i>Seat cover material is listed for CHEV only. A wide selection of colours is available to order on a special-order basis. - bright blue, off-white, dark saddle, dark metallic green, bright red, grey</i>		
1967 - 1968 Bucket Seats		
1967 - 1968 seat covers are made with madrid grain vinyl, dielectrically sealed inserts, horizontal ribs and 1/16 vertical lines. Includes cover for center console		
8-5768-BK	67-68 Bucket Seat Assembly - w/ console and floor support	Inquire
8-5768-BKF	67-68 Bucket Seat Foam Cushion - 1 upper & 1 lower, per seat	\$299.95
8-567-BK1	67-68 Seat Cover - black , buckets seats	\$525.00
1967 - 1968 Bench Seat - rear folds ahead		
8-5768-BF	67-68 Bench Seat Foam - lower only	\$269.95
8-5768-B1	67-68 Seat Cover - black , bench	Inquire
1969 - 1970 Bucket Seats		
1969 - 1970 bench or bucket seat covers are made with walrus grain vinyl (standard) & features authentic scroll detail, with repeating vertical pleats.		
	69-70 Bucket Seat Assembly - with console	Inquire
8-5970-BKF	69-70 Bucket Seat Foam Cushion - 1 rear & 1 lower, per seat	\$249.95
8-569-BK1	69-70 Bucket Seat Cover - black vinyl	\$495.95
1969 - 1970 Bench Seats		
	69-70 Bench Seat Assembly - has wire stand frame for hog rings	Inquire
8-5972-BF	69-72 Bench Seat Foam - 1 back and 1 lower, 2 pcs	\$424.95
8-569-B1	69-70 Bench Seat Cover - black vinyl	\$544.95
1971 - 1972 Bucket Seats (standard)		
71-72 bench or bucket seat covers (Cheyenne or CST) made with walrus grain vinyl (standard) & features authentic scroll detail (around each seating position) with repeating vertical pleats		
	71-72 Bucket Seat Assembly - with console	Inquire
8-5172-BKF	71-72 Bucket Seat Foam Cushion - 1 rear & 1 lower, per seat	\$269.95
8-571-BK1	71-72 Bucket Seat Cover - standard, black	\$539.95
1971 - 1972 Bench Seat (standard)		
	71-72 Bench Seat Assembly - frame has holes for hog rings	Inquire
8-571-B1	71-72 Bench Seat Cover - standard, black vinyl	\$499.95



8-5768-BKF



8-567-BK1



8-5768-BF



8-5970-BKF



8-569-BK1



8-5972-BF



8-569-B1



8-571-BK1



8-571-B1

Part No.		Price
1971 -1972 Bucket Seats (deluxe)		
<i>cloth hounds tooth inserts with original Walrus grain vinyl subs</i>		
8-571-DBK1	71-72 Deluxe Seat Cover - black vinyl - with black & white hounds tooth cloth insert	\$495.95
1971 - 1972 Bench Seats (deluxe)		
<i>cloth hounds tooth inserts with original Walrus grain vinyl subs</i>		
8-571-DB1	71-72 Deluxe Seat Cover - black vinyl - with black & white hounds tooth cloth insert	\$795.95
8-0240	67-80 Installation Hardware Kit - hog rings with pliers	\$9.95
8-5240-B	67-72 Burlap Bun Cover - 2pcs, 14ft total - reduces seat cover drag & bun wear	\$18.95
REPLACEMENT STYLE BENCH SEAT COVERS		
<i>- all madrid vinyl, with pleats, without the factory scroll</i>		
U107-2295	67-72 Bench Seat Cover - black	\$499.95
U107-4513	67-72 Bench Seat Cover - green	\$499.95
U107-4773	67-72 Bench Seat Cover - dark saddle	\$499.95
REPLACEMENT DELUXE BENCH SEAT COVER		
U107-922/4560	67-72 Bench Seat Cover - deluxe - black oxen vinyl w/ black, white cloth hounds inserts	\$579.95
U107-B923/0815	67-72 Bench Seat Cover - deluxe - metallic blue oxen vinyl, w/ black, blue cloth hounds inserts	\$579.95
BLAZER / JIMMY		
Bucket Seats		
8-571BLZ-SB	69-72 Blazer Seat Backs - black, plastic, pair	\$199.95
8-571-BLZ-BU1	71-72 Blazer Bucket Seat Cover - black	Inquire
Bench Rear Seat		
8-571-BB1	71-72 Blazer Bench Seat Cover - standard, black, vinyl	\$595.95
8-571-BDB1	71-72 Blazer Bench Seat Cover - deluxe, black vinyl subs - with black & white hounds tooth cloth insert	\$495.95
8-571BLZ-R	69-72 Rear Seat Retainer – blazer, pair	\$29.95
Blazer Boxside		
<i>Vinyl embossed panels, can be special ordered in various colours.</i>		
8-569-SP-1	69-72 Rear Side Panels - black, pair	\$779.95



8-571-DBK1

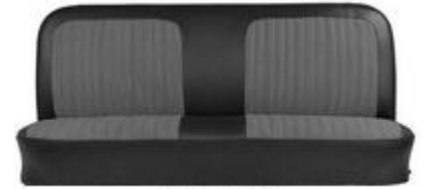

8-571-DB1



8-0240



8-5240-B



8-571BLZ-SB



8-571BLZ-R



Part No.		Price
SUNVISORS		
1967 - 1968 visors are made with Madrid grain vinyl and measure 17 3/4" pin to pin. 1969 - 1972 are made Walrus grain vinyl and measurer 19" pin to pin.		
8-520-1U	67-72 Sun Visor - black, walrus grain, offshore, each	\$74.95
8-520-11U	67-72 Sun Visor - dark green, madrid vinyl, offshore, each	\$74.95
9-520-21U	69-72 Sun Visor - dark aqua, madrid vinyl, offshore, each	\$74.95
9-520-25U	69-72 Sun Visor - light aqua, madrid vinyl, offshore, each	\$74.95
8-520-10	69-72 Sun Visors - bright blue, walrus grain, USA made, pair	\$189.95
8-520-11	69-72 Sun Visors - dark green, walrus grain, USA made, pair	\$189.95
8-520-15	69-72 Sun Visors - off white, madrid vinyl, USA made, pair	\$189.95
9-520-19	69-72 Sun Visors - dark saddle, madrid vinyl, USA made, pair	\$189.95
8-520-23	69-72 Sun Visors - white, madrid vinyl, USA made, pair	\$189.95
8-520-54	69-72 Sun Visors - dark blue, madrid vinyl, USA made, pair	\$189.95
8-520-H	67-72 Sun Visor Hook - black, pair, w/ hdw	\$13.95
8-520-HC	67-72 Sun Visor Hook - chrome, pair w/ hdw	\$18.95
8-520-HSK	67-72 Sun Visor Hook Screw Kit - 2pcs	\$0.65
8-520-BC	67-72 Sun Visor Bracket - chrome, left or right, w/ hdw, each	\$57.95
8-520-B	67-72 Sun Visor Bracket - black, left or right, w/ hdw, each	\$36.95
8-520-SK	67-72 Sun Visor Bracket Screw Kit - 6 pcs	\$4.25
8-520-BJ-L	69-72 Sun Visor Bracket - blazer / jimmy, left	\$119.95
8-520-BJ-R	69-72 Sun Visor Bracket - blazer / jimmy, right	\$119.95
HEADLINERS		
OE headliners have front to rear seams, replacement headliners have side to side seams		
8-525-H1	69-72 Headliner - black	\$324.95
8-525-H1-C	69-72 Headliner - replacement, black	\$249.95
8-525-H5	69-72 Headliner - red	\$324.95
8-525-H10	69-72 Headliner - bright blue	\$324.95
8-525-H11	69-72 Headliner - dark green	\$324.95
8-525-H15	69-72 Headliner - off white	\$324.95
8-525-H19	69-72 Headliner - dark saddle	\$324.95
8-525-H23	69-72 Headliner - white	\$324.95
8-525-HT	69-72 Headliner Trim - plastic chrome, w/ hdw, 4pcs - roof must have factory holes to install	\$169.95

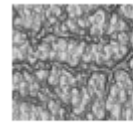

Walrus Grain

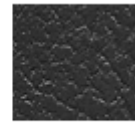

Madrid Grain



8-520-1U



8-520-H

8-520-HC



8-520-HSK

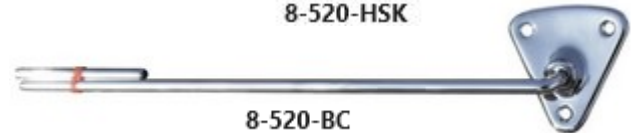

8-520-BC



8-520-X



8-520-B



8-525-H1-C

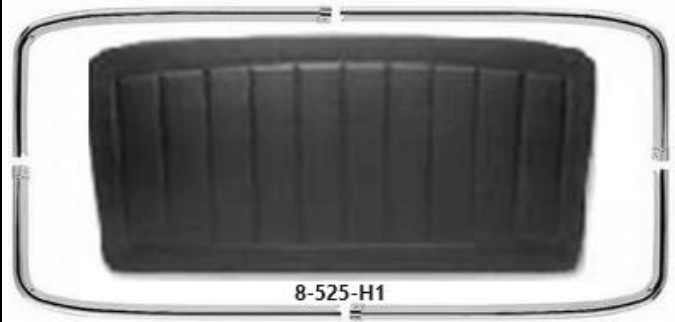

8-525-HT

Part No.		Price
DOOR PANELS		
<i>Door panels are available as a skin to be installed over your original steel panel, or as pre-assembled pads on ABS plastic formed panel. All pads are special order.</i>		
<i>1967 - 1968 Door skins are made with madrid grain vinyl, dielectrically</i>		
9-567-S1	67-68 Door Panel Skins - black, pair	\$225.95
9-567-S5	67-68 Door Panel Skins - red, pair	\$225.95
9-567-S10	67-68 Door Panel Skins - bright blue, pair	\$225.95
9-567-S20	67-68 Door Panel Skins - dark metallic green, pair	\$225.95
9-567-S12	67-68 Door Panel Skins - light green, pair	\$225.95
<i>1969 Door skins with Chev logo in center of upper scroll</i>		
9-569-S1	69-69 Door Panel Skins - black, pair	\$299.95
9-569-S5	69-69 Door Panel Skins - red, pair	\$299.95
9-569-S10	69-69 Door Panel Skins - bright blue, pair	\$299.95
9-569-S15	69-69 Door Panel Skins - off-white, pair	\$299.95
9-569-S18	69-69 Door Panel Skins - dark blue, pair	\$299.95
9-569-S23	69-69 Door Panel Skins - white, pair	\$299.95
<i>1970 - 1971 Door skins have a wood insert at top of panel</i>		
9-570-S1	70-71 Door Panel Skins - black, w/ woodgrain insert, pair	\$289.95
9-570-S19	70-71 Door Panel Skins - dark saddle, w/ woodgrain insert, pair	\$289.95
9-570-S14	70-71 Door Panel Skins - light saddle, w/ woodgrain insert, pair	\$289.95
9-570-S10	70-70 Door Panel Skins - bright blue, w/woodgrain insert, pair	\$289.95
9-570-S15	70-71 Door Panel Skins - off white, w/ woodgrain insert, pair	\$289.95
9-570-S18	70-71 Door Panel Skins - dark blue, w/ woodgrain insert, pair	\$289.95
9-570-S1-P	70-71 Door Panel Assembly - black, w/ woodgrain insert, pair	Inquire
<i>1972 Door panels are moulded heat resistant plastic, holes must be added to secure trim</i>		
9-572-D1	72-72 Door Panels - black, deluxe, w/o trim moulding holes, pair	\$439.95
9-572-I	72-72 Door Panel Inserts - woodgrain on aluminium, pair - with silver painted line detail	\$324.95
9-572-IP	72-72 Door Panel Inserts - woodgrain on plastic, pair - w/o silver painted line detail	\$199.95
9-572-T	72-72 Door Panel Insert Trim - stainless steel, pair	\$249.95
9-5774	72-72 Door Panel Fasteners - 18pcs, both doors	\$19.95



9-567-S1

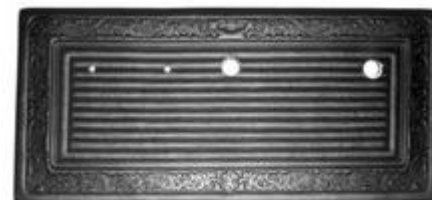

9-569-S1



9-570-S1



9-572-D1



9-572-I



9-572-T



9-5774

Part No.		Price
DOOR PANELS		
9-530-L	67-71 Door Panel - steel, left - with holes for handles and armrests	\$79.95
9-530-R	67-71 Door Panel - steel, right - with holes for handles and armrests	\$79.95
9-530-C	67-71 Door Panels - chrome, pair - with holes for handles and armrests	Inquire
9-530-SK	67-71 Steel Door Panel Screw Kit - chrome, 16 pcs (both doors) - hardware includes upper trim bar	\$14.95
9-530-SK-S	67-71 Vinyl Door Panel Screw Kit - chrome, 24 pcs (both doors) - used on vinyl skins, includes 8 trim washers	\$24.95
12-0851	56-71 Door Panel Nuts - nylon push in, pair	\$1.45
DOOR PANEL SEALS		
9-0430-S	67-72 Door Panels Seals - between panel & door, pair	\$13.95
DOOR PANEL MOULDING		
9-540-R	67-71 Door Panel Upper Moulding - chrome, pair - has a 3/8 gap for vinyl covered panels	\$99.95
DOOR HANDLE ESCUTCHEONS		
9-535-GR	67-71 Handle Escutcheon - green, each	\$5.95
9-535-BL	67-71 Handle Escutcheon - blue, each	\$5.95
9-535-BK	67-71 Handle Escutcheon - black, each	\$5.95
9-535-SD	67-71 Handle Escutcheon - saddle, each	\$5.95
9-535-P	67-71 Handle Escutcheon - parchment, each	\$5.95
9-535-GY	67-71 Handle Escutcheon - gray, each	\$5.95
9-535-R	67-71 Handle Escutcheon - red, each	\$5.95
12-0IHE	72-72 Handle Escutcheon - grey, each	\$2.95
DOOR HANDLE SPACERS		
Sponge Insulator spacers over handle handle shafts between door and door panel.		
9-567-S	67-71 Door Panel Handle Spacers - set of 4	\$9.95
9-572-S	72-72 Door Panel Handle Spacers - set of 4	\$14.95



9-530-R



9-530-SK



9-0430-S



12-0851



9-530-SK-S



9-540-R



9-535-BK



12-0IHE



9-567-S



9-572-S



Part No.		Price
ARMRESTS		
Armrests are made from polyurethane foam w/ original texture & include screws.		
9-0564-1	64-68 Armrest - black, left or right, each	\$44.95
9-0564-5	64-68 Armrest - red, left or right, each	\$44.95
9-0654-8	64-68 Armrest - grey, left or right, each	\$44.95
9-568-AR1	68-71 Armrest - black, left or right, each	\$39.95
9-568-AR5	68-71 Armrest - red, left or right, each	\$39.95
9-568-AR6	68-71 Armrest - saddle, left or right, each	\$39.95
9-568-AR8	68-71 Armrest - medium grey, left or right, each	\$39.95
9-568-AR10	68-71 Armrest bright blue, left or right, each	\$39.95
9-568-AR11	68-71 Armrest - dark green, left or right, each	\$39.95
9-568-AR15	68-71 Armrest - off-white, left or right, each	\$39.95
9-568-AR18	68-71 Armrest - dark blue, left or right, each	\$39.95
9-568-AR26	68-71 Armrest - parchment, left or right, each	\$39.95
9-572-ARR1	72-72 Armrest - black, right	\$39.95
9-572-ARL1	72-72 Armrest - black, left	\$39.95
9-572-ARR2	72-72 Armrest - blue, right	\$39.95
9-572-ARL2	72-72 Armrest - blue, left	\$39.95
9-572-ARR6	72-72 Armrest - saddle, right	\$39.95
9-572-ARL6	72-72 Armrest - saddle, left	\$39.95
9-572-ARR8	72-72 Armrests - medium grey, sold as a pair only, left & right	\$79.95
9-572-ARL11	72-72 Armrest - dark green, left	\$39.95
9-572-ARR11	72-72 Armrest - dark green, right	\$39.95
9-572-ARL18	72-72 Armrest - dark blue, left	\$39.95
9-572-ARR18	72-72 Armrest - dark blue, right	\$39.95
9-572-ARL26	72-72 Armrest - parchment, left	\$39.95
9-572-ARR26	72-72 Armrest - parchment, right	\$39.95
9-0773-AS	47-72 Armrest Screws - 1/4- 20 x 1 1/4", pair	\$2.00
9-0773-AN	47-72 Armrest Cage Nut - pair	\$4.95



9-0564-1



9-568-AR1



9-572-ARR1



9-0773-AN



9-0773-AS

Part No.		Price
REAR SEAT ARMRESTS (Blazer, Jimmy, Suburban)		
Armrests are made with polyurethane foam with the original texture and include hardware.		
9-5BAR-1L	69-72 Armrest - black, left	\$69.95
9-5BAR-1R	69-72 Armrest - black, right	\$69.95
9-5BAR-5L	69-72 Armrest - red, left	\$69.95
9-5BAR-5R	69-72 Armrest - red, right	\$69.95
9-5BAR-6L	69-72 Armrest - saddle, left	\$69.95
9-5BAR-6R	69-72 Armrest - saddle, right	\$69.95
9-5BAR-8L	69-72 Armrest - grey, left	\$69.95
9-5BAR-8R	69-72 Armrest - grey, right	\$69.95
9-5BAR-11L	69-72 Armrest - green, left	\$69.95
9-5BAR-11R	69-72 Armrest - green, right	\$69.95
9-5BAR-18L	69-72 Armrest - blue, left	\$69.95
9-5BAR-18R	69-72 Armrest - blue, right	\$69.95
9-5BAR-26L	69-72 Armrest - parchment, left	\$69.95
9-5BAR-26R	69-72 Armrest - parchment, right	\$69.95



9-5BAR-1L

VINYL DASH PADS

OE dash pads are vacuum formed vinyl, filled with polyurethane foam and metal backing.
USA made.

Reproduction dash pads are polyurethane material with steel backing, better to withstand high interior temperatures.

9-5DP-U1-USA	67-72 Dash Pad - polyurethane, w/ hdw, black, USA made	\$149.95
--------------	--	----------

Other colours are available by special order.

POLYURETHANE DASH PADS

9-5DP-U1	67-72 Dash Pad - polyurethane, black, w/ hdw	\$129.95
9-5DP-U5	67-72 Dash Pad - polyurethane, red, w/ hdw	\$129.95
9-5DP-U6	67-72 Dash Pad - polyurethane, saddle, w/ hdw	\$129.95
9-5DP-U8	67-72 Dash Pad - polyurethane, medium grey, w/ hdw	\$129.95
9-5DP-U10	67-72 Dash Pad - polyurethane, bright light blue, w/ hdw	\$129.95
9-5DP-U11	67-72 Dash Pad - polyurethane, dark green, w/ hdw	\$129.95
9-5DP-U18	67-72 Dash Pad - polyurethane, dark blue, w/ hdw	\$129.95
9-5DP-JK	67-72 J-nut - dash pad to steel dash, 4 pcs	\$3.95

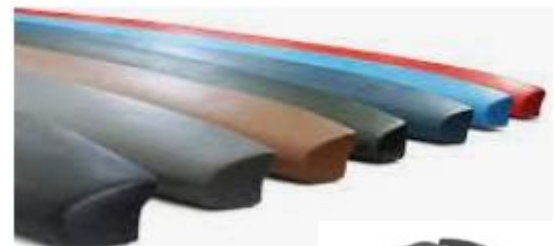

9-5DP-JK

Part No.		Price
CONSOLE PARTS		
Consoles are plastic reproductions.		
9-569-BP	69-72 Console Assembly - w/ seat belt pockets & ash tray	Inquire
9-0569-CP	69-80 Console Assembly - w/ cup holder pockets & w/o ash tray	Inquire
9-569-CT	69-72 Console Cover Trim - w/ ash tray & seat belt pockets - brushed stainless steel	\$19.95
9-569-G	69-72 Console Emblem - GMC	Inquire
30-569-C	69-72 Console Emblem - w/ blue, CHEV logo	\$79.95
9-0569-T	69-75 Console Trim - chrome	\$124.95

SEAT BELTS		
9-569-CBK	69-72 Seat Belt Cover - black, each - does not include GM decal	\$19.95
9-5769-BC	67-72 Lap Seat Belt - black, OE rears, 70", each - fits Pickup, center Blazer / Suburban, without GM decal	\$139.95
9-5769-B	67-72 Seat Belts - black, OE retractable, pickup, pair - does not include GM decal	\$289.95
9-5679-D1	67-72 Decal - GM belt decal, each	\$9.95
9-0769	Seat Belt Anchor Bolt - w/ lock washer, each - 1/2 x 1-1/4 NC-zinc plated, grade 8	\$2.25
9-0770	Upper Shoulder Seat Belt Bolt - w/ lock washer, each - 7/16 x 1 NF (20), grade 8	\$2.95
9-5771-HK	Seat Belt Anchor Bolts - OE style, 4 pcs - with inner collar bolts	\$36.95
9-510	67-72 Shoulder Harness Plug - black, pair	\$2.95

BLAZER / JIMMY SEAT BELTS		
9-569-BJ-B	69-72 Front Seat Belt Kit - black, pair - with correct right side vertical mount, add decal as required	\$299.95
9-569-BJ-R	69-72 Rear Seat Belt Kit - black, pair	\$299.95
9-569-BJ-C	69-72 Seat Belt covers - set of 4	\$49.95



Part No.		Price
FIREWALL GROMMETS		
10-0504-P	60-72 Park Cable Grommet	\$4.50
4-0208-5	64-72 Speedometer Cable Grommet - universal style - must be cut to fit over the large end of cable	\$2.95
4-5208	67-72 Speedometer Cable Grommet - OE style - must be cut to install on cable	\$5.50
10-0504-O	60-72 Oil Line Grommet - w/ 1" hole, USA made	\$5.50
10-0504-W3	60-72 Washer Hose Grommet - 3-hole, USA made - OE replacement	\$8.95
10-0504-W	63-72 Washer Hose Grommet - at cowl, pair - correct thin wall	\$5.95
10-504-K	67-72 Grommet Kit - 4pcs, - park, speedo cable, oil & washer hose	\$17.95
10-0504-B	67-72 Blank Grommet - punch holes as required, fits 7/8" hole - w/ OE steel clip design retainer	\$5.95
6-510-GD	72-72 Fuel Line Floor Grommet - double hole - some cabs had 1 double hole grommet or 2 single hole	\$4.95
6-0510-GS	60-71 Fuel Line Floor Grommet - single hole 7/16" diameter - fits 1" hole	\$2.95
CAB BOOTS & COVERS		
10-0504-BF	64-72 Power Brake Rod Boot - at firewall	\$9.95
10-0504-BB	64-87 Power Brake Rod Boot - at booster w/ vent holes	\$15.95
10-0504-MB	47-72 Master Cylinder Rod Boot - manual brakes	\$6.00
10-0504-PB	60-72 Pedal Arm Bumper - clutch & brake, each	\$9.95
10-0504-CB	64-72 Clutch Rod Boot - at firewall	\$12.95
10-0504-CC	64-72 Clutch Rod Cover - w /seal & screws - automatic transmission	\$14.95
10-0504-CCP	64-72 Clutch Rod Cover - plastic push in	\$8.95
10-0909	60-72 Clutch Fork Boot - at bell housing	\$14.95
10-0509	60-72 Rocker Panel Plugs - pair	\$1.95



Part No.		Price
COWL SCREEN		
10-510	67-72 Hood to Cowl Seal	\$21.95
20-516-S	67-72 Cowl Screen Screw Kit - 14 pcs - w/ piece of mechanic wire to repair over size holes	\$14.95
10-511	67-72 Cowl Screen Insulators - pair - glue to cowl screen at ends to add support	\$3.95
HOOD TO FENDER		
10-512-HC	67-72 Hood to Fender Cushions - 4pcs	\$5.95
10-0512-HA	67-74 Hood Adjusters - w/ cushions & lock nut, pair	\$4.95
10-512	67-72 Hood Brace Pad Set - sponge cushion	\$21.95
FENDER TO CAB		
10-513	67-72 Fender to Cab Seal Set - requires original hdw to install - correct for 71-72 but will also fit 67-70	\$42.95
10-513-S	67-72 Fender to Cab Seal Supports - left & right, w/ hdw - satin coat, includes install instruction	\$77.95
TAILLIGHT HARNESS GROMMET		
10-0420	60-72 Taillight Harness Grommet - fleetside, each - at rear cross sill, cut to fit	\$2.25
WINDSHIELD GLASS SEAL		
10-567-FS	67-72 Front Glass Seal - standard, (does not accept trim)	\$94.95
10-567-FD	67-70 Front Glass Seal - deluxe, (accepts deep centred trim)	\$94.95
10-571-FD	71-72 Front Glass Seal - deluxe, (accepts shallow centred trim)	\$94.95
REAR GLASS SEAL		
10-567	67-67 Rear Glass Seal - small back window	\$99.95
10-568-RS	68-72 Rear Glass Seal - standard, (does not accept trim)	\$94.95
10-568-RD	68-72 Rear Glass Seal - deluxe, (accepts shallow centred trim)	\$94.95
CAB GLASS TRIM		
10-567-FT	67-70 Front Glass Trim Kit - stainless, has 1/2 ext into seal	\$139.95
10-571-FT	71-72 Front Glass Trim Kit - stainless, has 1/2 ext into seal	\$139.95
10-567-RT	67-72 Rear Glass Trim Kit - stainless, has 1/2 ext into seal	\$139.95



Part No.		Price
DOOR GASKETS & BUMPERS		
Pickup (PK) Blazer (BL) Suburban (SUB)		
12-5HGS	67-72 Door Handle & Lock Gaskets - set	\$5.95
12-0015	64-72 Door Glass Bumper Set - in door bottom	\$4.95
11-0411	64-72 Door Bumper Set - 4 pcs <i>- fits pickup, blazer, suburban front door</i>	\$7.95
11-501-SUB	67-72 Door Bumper Set - suburban, 6 pcs	\$8.00
DOOR SEALS		
11-502	67-72 Door Seals - pickup, w/ molded corners, pair <i>- also fits suburban, panel front doors</i>	\$62.95
1-OWA	Weatherstrip Adhesive - black	\$16.95
11-502-1	67-72 Door Seals - pickup, w/ molded upper 45 deg, pair <i>- push on-wire core to secure to cab pinch weld, no glue required</i>	\$99.95
12-0500	60-91 Door Plugs - grey, rear end of door, pair	\$2.50
12-0500-B	60-91 Door Plugs - black, rear end of door, pair <i>- also fits suburban, panel rear hinge bolt holes</i>	\$1.95
DOOR GLASS CHANNEL RUNS		
11-505	67-72 Door Glass Channel Run - pickup, each	\$29.95
DOOR GLASS WIPERS		
11-506-D	67-72 Door Glass Wiper Kit - deluxe, w/ stainless outer bead <i>- fits pickup, blazer, suburban front door</i>	\$119.95
11-506-S	67-72 Door Glass Wiper Kit - standard, w/ black outer bead <i>- fits pickup, blazer, suburban front door</i>	\$89.95
11-0507	60-72 Division Bar Liner - each <i>- fits pickup, suburban 3rd & left side glass</i>	\$22.95
DOOR GLASS KITS		
11-508-SK	67-72 Door Glass Kit - 4 std wipers, 2 channels, 2 verticals <i>- fits pickup</i>	\$159.95
11-508-DK	67-72 Door Glass Kit - 4 deluxe wipers, 2 channels, 2 verticals <i>- fits pickup</i>	\$185.95
VENT GLASS SEALS		
11-510	67-72 Vent Glass Kit - pair <i>- fits pickup, blazer, suburban front door</i>	\$74.95
1-0VHK-64	64-87 Vent Hardware Kit - w/ pivot rivets & tool	\$16.95
2-010	Vent Window Pivot Rivets - pair	\$5.95



Part No.		Price
DOOR SEALS		
11-502-P	67-72 Door Seals - w/ molded corners, pair - push on-wire core to secure to cab pinch weld, no glue required	\$129.95
11-502-3P	67-72 Door seal - Suburban 3 rd w/ molded corner - push on-wire core to secure to cab pinch weld, no glue required	\$64.95
11-513-S	67-72 Rear Cargo Door Seals - w/ molded corners pair	\$104.95
CHANNEL RUNS		
11-505-S	67-72 Door Glass Channel Runs - pair, w/ square rear corner - fits suburban front & side doors, panel front	\$89.95
DOOR GLASS WIPER KIT		
<i>For front door use 11-506-S or 11-506-D</i>		
11-511-S	67-72 Rear 3 rd Door & I Stationery Wiper Kit - 4pcs	\$64.95
DOOR GLASS SEAL		
11-519-S	67-72 Rear Quarter Side Glass Seals - pair (special order) - in body, correct 1 piece design, with vulcanized corners	\$659.95
11-525-B	67-72 Rear Hatch Glass Seal - w/ black lock strip, - correct 1 pc, OE style, USA made	\$224.95
11-0525-B	60-72 Rear Door Hatch Glass Seal - w/ black lock strip, universal - also fits panel	\$79.95
11-0525-C	60-72 Rear Door Hatch Glass Seal - w/ chrome lock strip - also fits panel	\$84.95
11-525-D	67-72 Rear Barn Door Glass Seals - w/ black lock strip, pair - correct 1 pc, OE style, USA made	\$199.95
VENT GLASS SEALS		
<i>For fronts doors use 11-510</i>		
11-510-S	67-72 Vent Glass Kit - suburban 2nd doors	\$69.95
HATCH AND GATE SEAL		
11-515-S	67-72 Upper Hatch Seal	\$59.95
11-516-S	67-72 Lower Gate Seal	\$99.95
11-0514-S	60-72 Cargo Door Hinge Grommets - set of 4 - fits suburban & panel	\$49.95
12-0500	60-91 Door Hole & Hinge Access Plugs - grey, pair	\$2.50
12-0500-B	60-91 Door Hole & Hinge Access Plugs - black, pair	\$1.95
STRUT KIT		
11-515-SK	67-72 Upper Hatch Strut Kit - w/ pivot bolts - replace lock arm with these pressurized struts	\$99.95



11-502-P



11-502-3P



11-513-S



11-505-S



11-511-S



11-519-S



11-0525-B



11-525-B



11-510-S



11-525-D



11-515-S



11-516-S



11-0514-S



12-0500-B



11-515-SK

Part No.		Price
Blazer tops are single wall, (bolts from top down) or double wall, (bolts from bed up)		
DOOR SEALS		
11-502-B1	69-72 Door Seals - 1 pc design, OE molded, glue on, pair	\$299.95
11-502-B1-1	69-72 Door Seals - 1 pc design, pair <i>- push on-wire core, no glue required</i>	\$159.95
CHANNEL RUNS		
11-505-B	69-72 Door Glass Channel Runs - w/ moulded end cap, pair <i>- inside door at rear</i>	\$51.95
DOOR GLASS WIPERS		
<i>Use 11-506-S, 11-506-D same as pickups</i>		
DOOR GLASS SEALS		
11-511-BS	69-72 Door Glass to Top Seal - single wall, pair <i>- fits in steel or plastic channel on shell</i>	\$69.95
11-511-BD	69-72 Door Glass to Top Seal - double wall, pair <i>- attaches directly to shell (glue-screws)</i>	\$147.95
11-512-B	69-72 Door Glass Seal Retainers - 14pcs, double wall <i>- secures seal to fiberglass</i>	\$49.95
11-520-BS	69-72 Side Glass Seal - in roof, w/ single wall, each	\$114.95
11-520-BD	69-72 Side Glass Seal - in roof, w/ double wall, each	\$114.95
VENT GLASS SEAL		
<i>Use 11-510, same as pickups</i>		
11-525-C	69-72 Vent Window End Caps - w/ hdw, pair	\$89.95
12-569-BJ	69-71 Vent Window Screws - w/ plastic receiver button, set	\$29.95
ROOR SEALS		
11-513-B	69-72 Windshield Header to Roof Seal	\$49.95
11-515-BS-L	69-72 Roof to Bed Seals - w/ single wall, top, left	\$34.95
11-515-BS-R	69-72 Roof to Bed Seals - w/ single wall, top, right	\$34.95
11-515-BD	69-72 Roof to Bed Seals - w/ double wall, top, pair	\$169.95
DRIP RAIL DEFLECTORS		
11-514-B	69-72 Drip Rail Deflectors - pair	\$64.95
DOOR SEAL END PLUG		
11-503	69-72 Door Seal End Plug - pair	\$9.95



Part No.		Price
LIFT GATE SEALS & HARDWARE		
11-519-B-HCS	69-72 Lift Gate Hinge Covers - brushed stainless steel w/ hdw <i>- replaces the original covers, 2 on cap & 2 on upper gate</i>	\$49.95
11-521-B	69-72 Tailgate Side & Floor Seals - pair	\$29.95
11-521-B-R	69-72 Tailgate Side Seal Retainer Kit - 2 piece w/ hdw	\$99.95
11-518-B	69-72 Lift Gate To Body Seal	\$59.95
11-519-B-A	69-72 Lift Gate Glass Seal - 1 piece	\$114.95
11-516-B	69-72 Lift Gate Hinge Cover Gaskets - on roof, pair	\$22.95
11-517-B	69-72 Lift Gate Hinge Grommets - pair	\$69.95
11-521-BS	69-72 Tailgate to Top Filler Strip	\$189.95
11-522-G	69-72 Guide Plates - hatch alignment, pair	\$119.95
11-522-B	69-72 Lift Gate Stops - rubber bumper, each <i>- vulcanized to metal adjust strap, US made</i>	\$8.95
11-522-H	69-72 Lift Gate Handle	\$49.95
11-522-C	69-72 Hatch Center Latch Control	\$169.95
11-522-LS	69-72 Lift Gate Strikers - pair	\$169.95
11-522-S	69-72 Upper Hatch Supports - pair	\$169.95
11-523-BPT	69-72 Rear Inner Panel Trim Retainers - w/ hdw, pair <i>- stainless steel</i>	\$659.95
11-523-BPS	69-72 Rear Inner Panel Trim Mounting Guides - w/ hdw <i>- zinc plated brackets, w/ stainless hardware</i>	Inquire



Part No.		Price
DOOR LOCK KNOB		
12-501-67C	67-67 Door Lock Knobs - chrome, pair - correct for 67 but will also fit 68-72	\$5.95
12-501-67B	67-67 Door Lock Knobs - black, pair - correct for 67 but will also fit 68-72	\$6.95
12-0501-C	68-91 Door Lock Knobs - chrome, pair	\$5.50
12-0501-BK	68-91 Door Lock Knobs - black, pair	\$6.95



Part No.		Price
DOOR GLASS SASH & GUIDES		
12-505-SL	67-72 Door Glass Sash - roller guide & glass support, left - see group 13 for sash with glass	\$98.95
12-505-SR	67-72 Door Glass Sash - roller guide & glass support, right - see group 13 for sash with glass	\$98.95
12-505-GL	67-72 Door Glass Vertical Guide - at rear of door, left	\$99.95
12-505-GR	67-72 Door Glass Vertical Guide - at rear of door, right	\$99.95
12-0505-HK	64-72 Vertical Guide Screw Kit - 12 pcs - stainless screw & washer found at top of door	\$6.95



Part No.		Price
WINDOW REGULATOR		
12-567-LR	67-71 Window Regulator - left	\$59.95
12-567-RR	67-71 Window Regulator - right	\$59.95
12-572-LR	72-72 Window Regulator - left	\$59.95
12-572-RR	72-72 Window Regulator - right	\$59.95

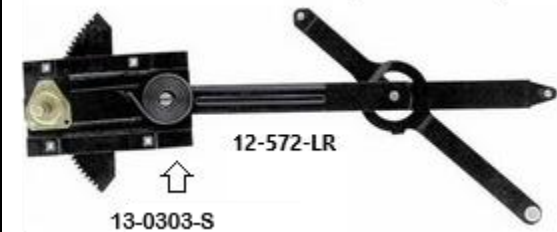

13-0203-SK	51-72 Window Regulator Screw Kit - 16 pcs, both sides	\$3.45
11-0510-R	64-72 Window Roller - w/ pin, each	\$6.25
13-0303-S	55-87 Window Regulator Assist Spring - fits left & right, each	Inquire



Part No.		Price
WINDOW & DOOR HANDLES		
12-0510-WH	67-76 Window Crank Handle - w/ clip & black knob, each	\$16.95
12-0510-WHC	67-76 Window Crank Handle - w/ clip & clear knob, each	\$14.95
12-510-DH	67-72 Door Handle - w/ clip, each	\$16.95
12-0510-C	67-87 Inner Handle Clips - 4 pcs	\$2.95



Part No.		Price
POWER WINDOWS		
Includes chrome GM switches, wiring harness, US made Siemen motors on original style window regulators with complete instructions. Brass iolite thrust bearings at pivots A Nu-Relics product.		
12-567-PW	67-72 Power Window Kit - w/ switches	\$984.95
12-567-PW-H	67-71 Power Window Kit - w/ new crank style switches - uses the original handles, includes harness	\$999.95
12-572-PW-H	72-72 Power Window Kit - w/ new crank style switches - uses the original handles, includes harness	\$999.95
VENT WINDOWS		
12-0984	67-72 Vertical Vent Window Bar - 37 1/2" long fits L & R, each - with stainless bead & felt, no holes or brackets	\$39.95
12-569-LVT	68-72 Vent Window - with tinted glass, left - with stainless steel post & chrome glass frame	\$469.95
12-569-RVT	68-72 Vent Window - with tinted glass, right - with stainless steel post & chrome glass frame	\$469.95
12-569-LVC	68-72 Vent Window - with clear glass, left - with stainless steel post & chrome glass frame	\$469.95
12-569-RVC	68-72 Vent Window - with clear glass, right - with stainless steel post & chrome glass frame	\$469.95
12-569-SK	67-72 Vent Assembly Install Kit - both sides	\$5.95
13-0213-S	51-91 Tension Spring - at vent window frame, each	\$10.95
12-572-S	72-72 Vent Window Screw - w/ sleeve & j-nut, 2 doors	\$13.95
VENT WINDOW HANDLE		
12-0518-S	68-91 Vent Handle Spacer - to glass, each	\$2.50
12-0518-L	60-67 Vent Window Handle - w/ washer & roll pin, left	\$19.95
12-0518-R	60-67 Vent Window Handle - w/ washer & roll pin, right	\$19.95
12-518-LVH	68-72 Vent Window Handle - w/ washer & roll pin, left	\$24.95
12-518-RVH	68-72 Vent Window Handle - w/ washer & roll pin, right	\$24.95



12-567-PW



12-0984



12-569-RVC



13-0213-S



12-572-S

12-569-RVT



12-0518-S



12-518-LVH



12-0518-L

Part No.		Price
DOOR CONTROL & RODS		
12-567-CR-L	67-72 Door Control Rods - 2 rods, w/ clips, left	\$37.95
12-567-CR-R	67-72 Door Control Rods - 2 rods, w/ clips, right	\$37.95
12-567-RC	67-72 Door Control Rod Clips, 3 pcs, right	\$6.95
12-567-LC	67-72 Door Control Rod Clips, 3 pcs, left	\$6.95
12-567-LDC	67-71 Door Control - left	\$33.95
12-567-RDC	67-71 Door Control - right	\$33.95
12-572-LDC	72-72 Door Control - left	\$33.95
12-572-RDC	72-72 Door Control - right	\$33.95
12-0205-K	47-72 Dr Control Screw Kit - 12 pcs, both sides	\$2.95
DOOR LATCHES		
12-567-LDL	67-72 Door Latch - left	\$89.95
12-567-RDL	67-72 Door Latch - right	\$89.95
12-0464-SK	60-72 Door Latch Screw kit - 12 pcs, both doors	\$5.95
DOOR STRIKER		
12-520-LS	67-72 Door Striker - left	\$33.95
12-520-RS	67-72 Door Striker - right	\$33.95
12-520-BP	67-72 Door Striker Base Plate - pair	\$49.95
12-520-SS	67-72 Door Striker Shim - 1/16" thick, each	\$1.95
12-520-S	67-72 Door Striker Screw Kit - 8 pcs, per striker	\$8.45
DOOR HINGES		
12-522-LU	67-72 Door Hinge - upper, w/ door check, left	\$84.95
12-522-LL	67-72 Door Hinge - lower, left	\$84.95
12-522-RU	67-72 Door Hinge - upper, w/door check, right	\$84.95
12-522-RL	67-72 Door Hinge - lower, right	\$84.95
12-522-BK	67-72 Door Hinge Bolt Kit - OE style, 6 pcs	\$18.95
12-522-CK	67-72 Door Hinge Check Kit - 2 nylon drags, 2 plates	\$19.95
12-0HPK	47-91 Door Hinge Pin Kit - 2 pins, 4 brass bushings - 2 x 11/32", 4 x 13/32" oversized brass bushings	\$12.95



Part No.		Price
DOOR LOCKS		
<i>67 & early 68 had round style keys, 69 up had square style. Door locks include retainers & gaskets</i>		
12-0525-68	68-91 Door Lock & Keys - pair	\$42.95
12-0525-68-B	68-91 Door Lock & Keys - black, pair	\$46.95
12-525-67K	67-67 Door Lock & Ignition Lock Set - w/ OE style keys	\$59.95
12-525-K	68-72 Door Lock & Ignition Lock Set	\$59.95
12-525-LK	68-72 Door Locks, Ignition & Glove Box Lock - w/ matching keys	\$79.95
DOOR LOCK PAWLS		
12-524-L	67-72 Door Lock Pawl - left	\$5.95
12-524-R	67-72 Door Lock Pawl - right	\$5.95
12-0524-R	67-91 Door Lock Pawl Retainer - pair	\$4.95
12-0525-R	67-05 Door Lock Retainer Clip - each	\$2.25
DOOR HANDLES		
12-527	67-72 Outer Door Handles - w/ gaskets, pair	\$114.95
12-527-L	67-72 Outer Door Handle - w/ gasket, left <i>- fits pickup, suburban, blazer, panel</i>	\$52.95
12-527-R	67-72 Outer Door Handle - w/ gasket, right <i>- fits pickup, suburban, blazer, panel</i>	\$52.95
12-5HGS	67-72 Door Handle & Lock Gaskets - set	\$5.95
12-0LG	67-87 Door Lock Gasket Set - rubber, pair	\$3.25



12-0525-68

12-0525-68B



12-525-67K



12-525-LK



12-524-L



12-0524-R



12-527



12-0525-R



12-00LG



12-5HGS



BILL'S TRUCK SHOP LTD.

CHEV

Est. 1987

GMC

40-90 PARTS & ACCESSORIES

PICTURE COMING SOON

Part No.		Price
WINDSHIELDS		
13-500-T	67-72 Windshield - tinted, w/ shaded top	\$269.95
13-500	67-72 Windshield - tinted only	\$299.95
13-500-C	67-72 Windshield - clear	\$269.95
REAR GLASS		
13-501-ST	67-67 Rear Glass - tinted, small back window	\$99.95
13-501-SC	67-67 Rear Glass - clear, small back window	\$99.95
13-501-LT	67-72 Rear Glass - tinted, big back window	\$189.95
13-501-LC	67-72 Rear Glass - clear, big back window	\$179.95
13-504-DTS	68-72 Sliding Back Window - w/ black frame, solar glass	\$424.95
13-0989	Latch Kit - sliding rear window, plastic	\$15.95
13-0989-M	Latch Kit - sliding rear window, metal	\$19.95
VENT GLASS		
<i>- use 1-0GST-1 on vent glass install</i>		
13-502-VT67	67-67 Vent Glass - tinted, w/ out vent handle hole, pair	Inquire
13-502-CT67	67-67 Vent Glass - clear, w/ out vent handle hole, pair	Inquire
13-502-T	68-72 Vent Glass - w/ green tint, left or right, each	\$69.95
13-502-C	68-72 Vent Glass - clear, left or right, each	\$44.95
GLASS SETTING TAPE		
1-0GST	Vent Glass Setting Tape - .047 thick, per foot	\$2.30
1-0GST-1	Door Glass Setting Tape - .062 thick, per foot	\$1.95
DOOR GLASS		
13-503-T	67-72 Door Glass - w/ green tint, each	\$82.95
13-503-C	67-72 Door Glass - clear, each	\$79.95
13-503-TL/S	67-72 Door Glass - w/ sash, tinted, left	\$234.95
13-503-TR/S	67-72 Door Glass - w/ sash, tinted, right	\$234.95
13-503-CL/S	67-72 Door Glass - w/ sash, clear, left	\$214.95
13-503-CR/S	67-72 Door Glass - w/ sash, clear, right	\$214.95
13-503-SCL/S	67-72 Door Glass - w/ sash, clear, left, (Suburban)	\$215.00
13-503-SCR/S	67-72 Door Glass - w/ sash, clear, right, (Suburban)	\$215.00
13-503-TS	67-72 Door Glass - tinted, each (Suburban)	Inquire
13-503-CS	67-72 Door Glass - clear, each, (Suburban)	Inquire



13-500-T



13-501-LT



13-504-DTS



1-0GST



13-0989-M



13-502-T



13-503-T



13-503-CL/S



13-503-SCR/S

Part No.		Price
SIDE MIRROR ARMS		
13-510-PL	67-70 Mirror Arm - painted, left	\$38.95
13-510-PR	67-70 Mirror Arm - painted, right	\$38.95
13-510-SL	67-70 Mirror Arm - stainless steel, left	\$47.95
13-510-SR	67-70 Mirror Arm - stainless steel, right	\$47.95
13-510-P	67-70 Mirror Arm Plate - inside door, each	\$17.95
13-510-G	67-70 Mirror Arm Gasket - w/ molded lip, left or right, each	\$2.95
13-0MS-A	55-70 Mirror Arm Screw Set - 3 OE collared style screws	\$7.95
13-0MS	55-70 Mirror Arm Screw Set - 3 stainless screws - ¼ x 20	\$4.95

SIDE MIRROR HEADS

When setting the mirror head for viewing, loosen the 3 set screws on back of head & then tighten when in desired location. This prevents scratching the pivot ball and future rusting.

20-0CM	47-70 Mirror Head - chrome, 5" round, ribbed, each	\$23.95
20-0PM	47-70 Mirror Head - black, 5" round, ribbed, each	\$17.95
20-0SRM	47-70 Mirror Head - rectangle, stainless, 8" high x 6" wide, each	\$27.95
20-0PRM	47-70 Mirror Head - rectangle, black, 8" high x 6" wide, each	\$24.95

SPORT MIRROR

13-512-L	71-72 Sport Mirror - chrome, w/ gasket, screws & plate, left	\$84.95
13-512-R	71-72 Sport Mirror - chrome, w/ gasket, screws & plate, right	\$84.95
13-512-RC	71-72 Sport Mirror - chrome, w/ gasket, screws & plate, right - convex mirror glass, objects are closer than they appear	\$84.95
13-512-PL	71-72 Sport Mirror Mount Plate - inside door, left	\$13.25
13-512-PR	71-72 Sport Mirror Mount Plate - inside door, right	\$13.25
13-512-GL	71-72 Sport Mirror Gasket - left, each	\$4.95
13-512-GR	71-72 Sport Mirror Gasket - right, each	\$4.95



13-510-P



13-510-G



13-0MS



13-0MS-A



20-0PM



20-0CM



20-0SRM



20-0PRM



13-512-G



13-512-PL



13-512-PR



13-512-L

Part No.		Price
	PEEP MIRROR	
20-0PM-C	Peep Mirror - 4" w/ curved arm, chrome, left or right	\$34.95
9-0PM-S	Peep Mirror - 4" w/ straight arm, chrome, left or right	\$36.95
13-0977	60-87 Mirror Screw - 1 stainless screw with jack nut - used when installing camper mirrors	\$8.95
	INSIDE MIRROR	
13-0510	60-71 Inside Mirror Head - stainless steel	\$39.95
13-0510-M	60-71 Anti-movement Insert - w/ screw	\$4.95
13-0510-DN	65-71 Day & Night Inside Mirror Head - stainless steel	\$69.95
13-0510-B	60-71 Inside Mirror Bracket - chrome, w/ screws - includes 13-0510-M	\$29.95
13-0510-SK	60-71 Inside Mirror Screw Kit - 3 pcs	\$1.50
13-514-69	69-71 Inside Mirror Bracket - chrome, w/ black cover - w/ screws	\$49.95
13-514-69BLU	69-71 Inside Mirror Bracket - chrome, w/ blue cover - w/ screws	\$49.95
13-514-69GR	69-71 Inside Mirror Bracket - chrome, w/ green cover - w/ screws	\$49.95
13-514-69PAR	69-71 Inside Mirror Bracket - chrome, w/ parchment cover - w/ screws	\$49.95
13-514-69R	69-71 Inside Mirror Bracket - chrome, w/ red cover - w/ screws	\$49.95
13-514-69SAD	69-71 Inside Mirror Bracket - chrome, w/ saddle cover - w/ screws	\$49.95
13-514-69-CB	69-71 Inside Mirror Support Cover - black	\$12.95
13-514-69-CBLU	69-71 Inside Mirror Support Cover - blue	\$12.95
13-514-69-CSAD	69-71 Inside Mirror Support Cover - saddle	\$12.95
13-514-69-CGR	69-71 Inside Mirror Support Cover - green	\$12.95
13-514-69-CPAR	69-71 Inside Mirror Support Cover - parchment	\$12.95
13-514-69-CR	69-71 Inside Mirror Support Cover - red	\$12.95
13-0515	72-87 Day & Night Inside Mirror - w/ support - stainless back	\$99.95
13-0515-B	72-87 Day & Night Inside Mirror - w/ support - black on back	\$92.95
13-0MGK	72-87 Mirror Glue Kit	\$9.95



Part No.		Price
RADIATOR MOUNT KIT		
<i>10 is 1/2 ton, 20 is 3/4 ton, C is 2-wheel drive, K is 4-wheel drive</i>		
14-0625	60-68 Rad Support Mount Kit - w/ hdw - C & K 10/20	\$37.95
14-535-HK	69-72 Rad Support Mount Hardware Kit - w/o sleeves	\$12.95
14-535-C	69-72 Rad Support Mount Kit - OE rubber style , w/ hdw - C & K 10/20, pickups, blazers, suburban	\$59.95
14-535-P	69-72 Rad Support Mount Kit - polyurethane , w/ hdw - C & K 10/20, pickups, blazers, suburban	\$39.95
CAB MOUNT KIT		
14-525-PC-67	67-68 Cab Mount Kit - polyurethane , C-10, w/ hdw	\$99.95
14-525-C	67-72 Cab Mount Kit - OE rubber , C-10, w/ hdw	\$119.95
14-546-CK-OE	67-72 Cab Mount Kit - OE rubber , C-20 & K-10-20, w/ hdw	\$159.95
14-550-B	69-72 Blazer Body Mount Kit - w/ hdw - original style rubber cushions, 2 & 4 wheel drive	\$599.95
14-550-SP	67-72 Suburban & Panel Body Mount Kit - w/o bolts & sleeves - original style rubber cushions	\$299.95
14-550-SP-P	67-72 Suburban & Panel Body Mount Kit - poly , w/ hdw	\$354.95
CAB & RAD MOUNT KIT		
14-525-PC	69-72 Cab & Rad Mount Kit - polyurethane , C-10, w/ hdw	\$159.95
14-546-CK	67-72 Cab & Rad Mount Kit - polyurethane , C-20 & K-10-20 - w/o rear cab & rad mount bolts	\$159.95
CAB & RAD SUPPORT FRAME BRACKETS		
14-535-67R	67-68 Rad Support Frame Bracket - pair, w/ hdw - has smaller mount sleeve hole	\$69.95
14-535-R	69-72 Rad Support Frame Bracket - pair, w/ hdw	\$69.95
14-525-CF	67-72 Cab Support Frame Bracket - front, each	\$59.95
14-525-CR	67-72 Cab Support Frame Bracket - rear, w/ hdw, each - C-10/20 & K-10/20 trucks, mounts are located lower on frame	\$49.95
14-525-CFP	67-72 Cab Support Repair Patch - each - can be welded on upper or lower side of rear frame bracket	\$9.95
14-000S-5/8	60-72 Body Mount Shim - 1/8" thick w/ 5/8" hole, front, pair	\$5.95
14-000S-1/2	60-72 Body Mount Shim - 1/8" thick w/ 1/2" hole, rear, pair	\$5.95
14-000S-KIT	60-72 Body Mount Shim Kit - 4 shims - 2 front, 2 rear, 14-gauge galvanized steel	\$9.95



Part No.		Price
ENGINE MOUNTS		
14-0021	63-72 Engine Mount - 6 or 8cyl, w/ centre bolt, each	\$24.95
14-0021-P	63-72 Engine Mount - polyurethane, zinc, black, each	\$89.95
14-0510-M	62-72 Engine Mount Cushions Kit - big block , w/ hdw, each	\$129.95
<i>Below mounts have a side to side through bolt</i>		
40-0220-M	Engine Mount - rubber style, each	\$21.95
40-0220-MP	Engine Mount - polyurethane, w/ zinc frame, each	\$44.95
14-0292	72-87 Engine Mount - 6 or 8cyl, each	\$34.95
ENGINE MOUNT BRACKETS		
14-0411-6	63-72 Engine Mount Brackets - 6 cyl, 230/250 motor, pair	Inquire
14-0411-8	63-72 Engine Mount Brackets - 8 cyl, pair	\$169.95
14-0510-B	63-72 Engine Mount Brackets - big block , pair - OE stamped design	\$159.95
14-0510-SM	63-72 Engine Mount Brackets - small block , pair - uses 40-0220-M or 14-0021-P engine cushion	\$169.95
REAR MOTOR MOUNTS		
14-0214	54-72 Rear Motor Mounts - w/ manual trans, per side - 1 upper & 1 lower	\$32.95
14-0214-60K	60-72 Rear Mount Hardware Kit - 6pcs	\$26.95
14-0214-K	60-72 Transmission Mount Keeper Washer - each	\$7.95
14-0107	65-75 Transfer Case Side Mount Cushion Set - 6pcs - polyurethane with sleeves	\$42.95



Part No.		Price
TRANSMISSION SUPPORT		
14-025-S	63-72 Transmission Support - auto or std, at rear of trans - OE style	\$179.95
14-025-ST	63-72 Transmission Support - auto or std, OE 3pc set - tube type, may require drilling on 63-66	\$149.95
14-025	63-72 Rear Trans Mount - auto & 3 or 4 speed transmissions	\$26.95
14-025-1	63-72 Rear Trans Mount - auto 400 transmission	\$29.95
HANGER BEARING		
14-030-SB	63-72 Hanger Bearing Support Bracket - front to rear mount	\$49.95
14-030-F	63-72 Driveshaft Hanger Bearing - front to rear mount	\$91.95
14-0030-F-HD	63-72 Driveshaft Bearing Support - front to rear mount - heavy duty aluminum housing w/ high impact poly cushion	\$189.95
14-030-S	63-72 Driveshaft Hanger Bearing - w/ side to side mount - with hardware, 1.3780" ID	\$69.95
FRAME SHORTENING KIT		
FRAME KIT	64-72 Frame Shortening Template	Inquire
14-0FIS	64-72 Reinforcement Frame Insert - pair - weld in support when shorting frame 14 ga x 12" long	\$49.95
SPARE TIRE HARDWARE		
14-0600	60-72 Spare Tire Cross Support - w/o front & rear stand	\$89.95
14-0600-F	60-72 Spare Tire Guide - front	\$12.95
14-0600-R	60-72 Spare Tire Guide Support - rear	\$26.95
14-0600-1	54-87 Spare Tire Support Lock Bolt - carriage bolt style - with upper lock plate & retainer	\$22.95
14-0600-2	54-87 Spare Tire Support Lock Nut - nylon insert	\$12.95
14-0600-3	54-87 Spare Tire Support Pivot Bolt - w/ lock nuts	\$22.95
14-0600-4	54-87 Spare Tire Upper Lock Bolt Retainer - each	\$0.45



Part No. **Price**

The standard aftermarket drops spindles that are used on '60 - 87 Chevy trucks are loosely based on '71-87 stock spindles. These drop spindles allow you to keep your stock coil, stock shock, steering geometry and get a 2½-inch drop without any other modifications. The only issue with these drop spindles is that on '63-70 trucks it widens the track width approximately ¾ inch per side.

In 1971, GM released trucks that came standard with disc brakes. In doing this they had to widen the track width ¾ inch per side (actually, late '70 trucks came with a 1½-inch wider rear end in anticipation of the disc brakes). This could become an issue if using custom wheels and/or tires

FRONT STOCK HEIGHT SPINDLES

10 is 1/2 ton, 20 is 3/4 ton, C is 2-wheel drive, K is 4-wheel drive

29-567-S	67-70 Front Spindle - drum brake, left or right, each - fits C-10 or C-20, stock height	Inquire
15-571-SS	71-72 Front Spindle - disc brake, left or right, each - fits C-10 or C-20, stock height	\$495.00
15-06370-SOE	63-70 Disc Brake Spindles - stock height , C-10, pair - used to convert to disc brakes, accepts factory ball joints and tie rods ends	\$495.00

FRONT DROP HEIGHT SPINDLES

NOTE - All Spindles are US made. Cast from high quality ductile iron with 4140 chrome moly CNC machined pins. Spindles are 2 1/2 drop

15-06370-DSOE	63-70 2.5" Drop Spindles - w/ disc brakes, C-10, pair - OE application, uses original ball joints & tie rod ends	\$524.95
15-571-DSOE	71-72 2.5" Drop Spindles - C-10, pair - OE application, requires longer flex hoses, add hose kit 17-5712-DK	\$524.95
15-0571-DC20	71-87 2.5" Drop Spindles - C-20, pair	\$699.95

UPPER BALL JOINTS

15-0414-U	63-70 Ball Joints - upper, C-10	\$48.95
15-0414-U-A	63-70 Ball Joints - upper, C-10, US MADE	\$74.95
15-0414-U20	63-70 Ball Joints - upper, C-20	\$79.95
15-514-U	71-72 Ball Joints - upper, C-10	\$44.95
15-0514-U20	71-86 Ball Joints - upper, C-20	\$46.65
15-514-UK	67-72 Ball Joints - upper, K-10 & 20, each	\$49.95

LOWER BALL JOINTS

15-0414-L	63-70 Ball Joints - lower, C-10	\$39.95
15-0414-L-A	63-70 Ball Joints - lower, C-10, US MADE	\$49.95
15-0414-L20	63-70 Ball Joints - lower, C-20	\$57.95
15-0118	71-87 Ball Joints - lower, C-10	\$49.95
15-0514-L20	71-86 Ball Joints - lower, C-20	\$29.95
15-0514-LK	70-80 Ball Joints - lower - K-10 & 20, each	\$29.95

WHEEL ALIGNMENT SHIMS

15-0116	Alignment Shim - galvanized, 1/16, with 9/16 slot, each	\$0.75
15-0018	Alignment Shim - galvanized, 1/8, with 9/16 slot, each	\$1.35
15-00KIT	Alignment Shim Kit - galvanized, 4 x 1/8" and 6 x 1/16", kit	\$9.95



15-571-SS



15-06370-DSOE

Inquire with one of our staff about front disc brake kits, 5 & 6 stud.



15-0414-U



15-514-U



15-514-UK



15-0514-U20



15-0414-L



15-0118



15-0414-L20



15-0018



15-0514-LK

Part No.		Price
UPPER CONTROL ARMS (inquire about used 1/2 & 3/4 ton)		
15-0517-CA10L	63-72 Upper Control Arm - w/ shaft, C-10, left, each	\$159.95
15-0517-CA10R	63-72 Upper Control Arm - w/ shaft, C-10, right, each	\$159.95
19-0518-L	63-72 Support - upper control arm to frame, 1/2 ton, left	\$329.95
19-0518-R	63-72 Support - upper control arm to frame, 1/2 ton, right	\$329.95
15-0517-234	63-72 Upper Control Arm Stud - 2 3/4", w/ nut, 1/2 ton, each	\$14.95
15-0517-314	73-91 Upper Control Arm Stud - 3 1/4", w/ nut, 1/2 ton, each <i>- can also be used on 60-72 1/2 ton when more camber is required over the stock length 2 3/4" long</i>	\$14.95
15-0517-W	63-72 Upper Control Arm Convex Washers - 1/2 ton, 4pcs	\$14.95
NOTE - 63-70 1/2 ton upper control arm shaft has a 13/16" threaded end. 3/4 ton & up have a 1" threaded end & concave surface at camber bolt.		
15-0517-U10	63-72 Upper Control Arm Shaft & Bushing - C-10, each <i>- has a 9/69 adjust bolt</i>	\$64.95
15-0517-U20	63-72 Upper Control Arm Shaft & Bushing - C-20 & up <i>- has a 5/8 adjust bolt hole</i>	\$64.65
15-0560-B	63-91 Upper Control Arm Bumper - 2WD, 1/2 & 3/4 ton, each	\$8.95
15-0560-BP	63-91 Upper Control Arm Bumper - poly, bolt on, pair <i>- 1 1/2 x 1 1/2, can also be used as axle bumpers</i>	\$36.95
15-0517-S	63-72 Upper Control Arm Bushing Grease Seal - C-10	\$8.95
15-0517-S20	63-72 Upper Control Arm Bushing Grease Seal - C-20 & up	\$9.95
LOWER CONTROL ARMS (inquire about used 1/2 & 3/4 ton)		
15-0CA-10L	63-72 Lower Control Arm - C-10, left, each	\$399.95
15-0CA-10R	63-72 Lower Control Arm - C-10, right, each	\$399.95
15-0570-B	63-91 Lower Control Arm Bumper, each	\$12.95
NOTE: Some GM trucks were built using 1/2" diameter U-Bolts and were prone to breakage. They were later upgraded by GM to 9/16". If your vehicle still has the 1/2" diameter bolts they should be upgraded to the 9/16" bolts. Enlarging the 1/2" diameter holes with a 19/32" or 15mm drill bit will be required for vehicles still equipped with the 1/2" U-bolts.		
15-0518-9	64-91 Lower Control Shaft U-Bolts - 9/16" w/ deep nuts, each	\$18.95
LOWER CONTROL ARM SHAFT SEATS		
15-0LSS-L	64-72 Lower Control Arm Seats -, left, front or rear, each <i>- C-10 & C-20</i>	\$34.95
15-0LSS-R	64-72 Lower Control Arm Seats - right, front or rear, each <i>- C-10 & C-20</i>	\$34.95
LOWER CONTROL SHAFT SEALS & BUSHINGS		
15-0518-LB	63-72 Lower Control Shaft Bushing, Seal & Fitting - each <i>- 1/2, 3/4 and 1 ton</i>	\$19.95
15-0518-S	63-72 Lower Control Arm Bushing Grease Seal - each	\$7.95
15-0518-SL	63-72 Lower Control Arm Shaft - w/ bushing, C10 & 20 each	\$79.95



Part No.		Price
TIE RODS C-10 & C-20		
15-0520-I	65-70 Tie Rod End - inner, left or right, C-10, each	\$34.95
15-0520-I20	65-70 Tie Rod End - inner, left or right, C-20, each	\$54.95
15-0520-O	65-70 Tie Rod End - outer, left or right, C-10, each	\$36.95
15-0520-O20	65-70 Tie Rod End - outer, left or right, C-20, each	\$49.95
15-521-I	71-72 Tie Rod End - inner, left or right, C-10, each	\$33.95
15-521-I20	71-72 Tie Rod End - inner, left or right, C-20, each	\$45.00
15-521-O10	71-72 Tie Rod End - outer, C-10, left or right, each	\$59.95
15-0521-O	71-86 Tie Rod End - outer, C-20, left or right, each - also fits 73-87 C-10	\$58.95
TIE RODS K-10 & K-20		
15-522-KL	67-72 Tie Rod End - outer, K-10 & K-20, left	\$129.95
15-522-KR	67-72 Tie Rod End - outer, K-10 & K-20, right	\$129.95
15-521-F	69-72 Tie Rod End - at pitman arm, 4x4	\$86.95
15-521-R	69-72 Tie Rod End - at steering arm, 4x4	\$86.95
TIE ROD SLEEVES		
15-04SC-63S	63-64 Custom Tie Rod Sleeves - 8 1/4" long, pair - for converting to 73-87 disc brakes, connects 11/16" tie rod to 5/8" tie rod	\$89.95
15-04SC-SA	65-70 Custom Tie Rod Sleeves - 5" long, pair, aluminium, black - for converting to 73-87-disc brakes, connects 11/16" tie rod to 5/8" tie rod	\$129.95
15-0520-S	65-70 Manual Tie Rod Sleeve - C-10 & 20, each - also fits 69-70 with power steering	\$24.95
29-520-S20	67-70 Tie Rod Sleeve - w/ power steering, C20, each	\$39.95
15-0521-S	71-87 Tie Rod Sleeve - C-10 & 20, each	\$15.95
15-521-S	69-72 Tie Rod Sleeve - K-10, 4x4	\$29.95
TIE ROD BOOT		
39-0176	Tie Rod Boot - w/ 9/16 shaft diameter, each	\$5.95
39-0177	Tie Rod Boot - w/ 5/8 shaft diameter, each	\$5.95
GREASE FITTING		
39-0221	Grease Fitting - 1/4 - 28 pipe thread, straight, each	\$1.45
39-0222	Grease Fitting - 1/4 - 28 pipe thread, 45 deg, each	\$1.25



Part No.		Price
IDLER ARM		
29-0525	67-82 Idler Arm - C-10, 20, & 30	\$59.95
PITMAN ARM		
15-526-69	67-72 Pitman Arm - w/ manual steering, C-10 & 20	\$69.95
15-526-PS	69-72 Pitman Arm - w/ power steering, C-10 & 20	\$84.95
15-0526-PSK	69-87 Pitman Arm - w/ power steering, K-10 & 20	Inquire
15-0535-K	69-87 Power Steering Pitman Arm Nut - w/ lock washer	\$6.95
40-0055	47-72 Pitman Shaft Seal - w/ manual steering	\$16.95
STEERING DRAG LINK		
15-530-KF	70-91 Steering Drag Link Tie Rod - front, K-10 & 20	\$94.95
15-530-KR	70-91 Steering Drag Link Tie Rod - rear, K-10 & 20	\$89.95
15-530-S	70-72 Steering Drag Link Sleeve - K 10 & K 20	\$49.95
CENTRE LINK		
15-5567	67-70 Steering Centre Link - C-10	\$199.95
15-5571	71-72 Steering Centre Link - C-10	\$199.95
POWER STEERING BOX		
Power steering boxes have an additional \$125.00 core charge when not exchanging cores.		
15-0CORE	Steering Box Core Charge	\$125.00
29-535-MC	67-68 Steering Box - manual, C & K	Inquire
15-0535-MC	67-76 Steering Box - manual, 2x2, rebuilt	\$345.95
15-0535-MK	68-76 Steering Box - manual, 4x4, rebuilt <i>- check for rag joint application</i>	\$345.95
15-0535-PC	68-76 Power Steering Box - 2x2, rebuilt, 17-1 ratio <i>- with flared type hose fitting, check for rag joint application</i>	\$424.95
15-0535-PK	68-76 Power Steering Box - 4x4, rebuilt, 3/4-30 <i>- with flared type hose fitting, check for rag joint application</i>	\$495.00
15-0535-PC-1	46-86 Power Steering Box - 2x2, rebuilt, 17-1 ratio <i>- with o-ring type hose fitting, check for rag joint application</i>	\$495.00
15-0535-PCQ	68-76 Power Steering Box - 2x2, rebuilt, 14-1 ratio, quick ratio <i>- with flared type hose fitting, check for rag joint application</i>	\$495.00
15-0801	73-87 Steering Shaft Boot Kit - boot, w/ locating washer	\$19.95
15-5801	69-72 Steering Shaft Boot - 1 1/8" OD, replacement style <i>- 1972 & under comes with 3/4 round end for column</i>	\$19.95



Part No.		Price
STEERING BOX SEALS		
15-0117	68-87 Steering Box Seal Kit - input, output & cover	\$79.95
15-0535-SK	68-87 Steering Box Seal Kit - output shaft - seals, spacers, snap rings	\$39.95
15-0131	68-80 Power Steering Box Seal Kit - input shaft - seals, spacers, snap rings	\$42.95
POWER STEERING PRESSURE HOSES		
Power steering hoses came in 2 different end styles. See part # info. Can also add fitting to pump #15-0540-FV		
15-0768-K	67-68 Power Steering Hose Kit - w/ ram style steering	\$275.00
15-540-HC	68-72 Power Steering Hose - 8cyl, C10 & 20 - also fits 70-72 6cyl, K-5/10/20, male fittings on both ends	\$64.95
15-540-BB	69-72 Power Steering Pressure Hose - big block, OE style	\$149.95
POWER STEERING RETURN HOSES		
15-540-BB-R	69-72 Power Steering Hose Return - big block, OE style	\$49.95
15-0540-BB-H	Power Steering Reservoir Hose - BB, correct 3/4, 20" long	\$27.95
15-0059	Power Steering Return Hose - 18" x 3/8 ID	\$8.00
POWER STEERING RETURN PIPE		
15-0540-RL	68-77 Power Steering Return Pipe - 20" long, w/ flared end	\$54.95
15-0540-RL-B	68-72 Power Steering Return Pipe - w/ o-ring end	\$19.95
15-0540-FV	58-74 Power Steering Pump Flow Valve - w/ flare pipe	\$19.95
POWER STEERING PUMP MOUNTS		
15-0741	63-74 Power Steering Pump Mount Kit - 6cyl. 230 - 250	\$199.95
15-0PMK-8	64-72 Power Steering Pump Mount Kit - 8cyl, - works with short neck water pump, w/ 8 x 1 1/4 balancer, exact copy of OE GM	\$139.95
15-0301	64-72 Power Steering Pump Mount Kit - small block, V8 - works with short & long neck water pumps	\$69.95
15-0PMK-BB	66-72 Power Steering Pump Mount Kit - big block - works with short neck water pumps	\$105.95



Part No.		Price
POWER STEERING PUMP		
15-0540-BB-P	66-72 Power Steering Pump - big block, requires nut on pulley - without remote reservoir	\$285.95
15-0540-BB-R	66-72 Power Steering Pump Remote Reservoir - big block - includes cap	\$99.95
15-0540-R	68-72 Power Steering Pump Reservoir - 9 o'clock return - fits 6cyl, or small block	\$79.95
15-0540-R1	68-72 Power Steering Pump Reservoir - 7 o'clock outlet	\$59.95
15-0160	Power Steering Pump - w/ 9 o'clock return, 7 o'clock outlet - fits 6 & 8cyl, without pulley, with nut & cap, REBUILT	\$169.95
15-0168	Power Steering Pump - w/ 9 o'clock return pipe 7 o'clock outlet - fits 6 & 8cyl, without pulley, with nut & cap, NEW	\$249.95
POWER STEERING PUMP SEALS & CAP		
15-0140	Power Steering Pump Seal Kit - seals and O-rings	\$34.25
15-0140-A	Power Steering Pump Reservoir O-ring Kit	\$14.95
15-0581	Steering Pump Cap - plastic cap	\$10.95
15-0581-OE	Steering Pump Cap - OE, metal style	\$29.95
POWER STEERING PULLEYS		
15-0509	63-74 Power Steering Pulley - single groove, nut on, SB - replaces GM# 3770509	\$69.95
15-0508	Power Steering Pulley - double groove, nut on - replaces GM# 3941107	\$69.95
15-0810	Power Steering Pulley - single groove, nut on, back spaced - replaces GM# 3834720	\$69.95
15-0033	Power Steering Pump Pulley - press on 5/8 shaft	\$58.00
15-0940	63-75 Power Steering Pump Nut - OE style	\$14.50
15-00HN	Power Steering Pulley Nut - replacement	\$0.75
15-0811	Crank Pulley - double groove, SB - replaces GM# 3744043	\$79.95
15-0812	Crank Pulley - steel, single groove, SB - add on for power steering, replaces GM# 3751232	\$69.95
50-0142	SB-GM Pulley - short neck water pump, 6" 2 grooves - replaces GM# 3995642	\$94.95



Part No.		Price
POWER STEERING PUMP PULLEY		
44-0487	58-86 Small Block GM Alternator Pulley <i>- Aluminium machined finish alternator fan & alternator pulley set. The pulleys have one groove, 2.8" diameter. Comes with three hex key head bolts.</i>	\$34.95
44-0478	58-86 Small Block Water Pump Pulley <i>- 6 3/4 OD w/ 2 3/4 offset aluminium machined finish, single groove water pump pulley for the small block Chevy engine with long neck water pump.</i>	\$44.95
44-0480	58-86 Small Block Crankshaft Pulley - single groove <i>- 6 3/4 OD flush mount, aluminium machined finish, crank pulley for the small block Chevy engine with short water pump/single groove.</i>	\$34.95
44-0485	58-86 Small Block Crankshaft Pulley - double groove <i>- 6 3/4 OD w/ 2 1/2 offset flush mount, aluminium machined finish crank pulley for the small block Chevy engine with long water pump/double groove</i>	\$48.95
POWER STEERING BELT		
15-0350	Power Steering Belt - V8, small block, 3/8 x 35-5/8 V belt	\$24.95
STEERING COUPLER		
<i>For coupler application count splines on 1/2 and double</i>		
15-0537-K	60-87 Steering Coupler Joint Repair Kit - manual & power	\$27.95
15-0537-M	60-68 Steering Coupler Joint - manual C/K-10 & 20	\$79.95
15-0537-P1	68-76 Power Steering Coupler - 3/4 shaft, w/ 36 splines	\$99.95
15-0537-P2	68-76 Power Steering Coupler - 3/4 shaft, w/ 30 splines	\$99.95
15-0537-P	69-76 Power Steering Coupler - 13/16 shaft, 36 splines <i>- applies to most 1969 - 1976 steering boxes</i>	\$99.95
COLUMN STEERING SHAFT EXTENSIONS		
<i>- 3/4 DD shaft when extending from column to steering rack or box</i>		
40-1850-DD	- un-plated steel, 18"	\$64.95
40-1850-DDN	- nickel plated, 18"	\$64.95
40-1850-DD-SS	- stainless steel, 18"	\$61.95
40-3650-DD	- un-plated steel, 36"	\$69.95
40-3650-DD-SS	- stainless steel, 36"	\$89.95
COLLAPSABLE STEERING SHAFT		
40-0626-AD	Adjustable Steering Shaft, 16" to 26", nickel plated	\$119.95
40-0636-AD	Adjustable Steering Shaft, 24" to 35", nickel plated	\$119.95
ITERMEDIATE SHAFT & FLANGE		
40-00SF	9 1/4 - 3/4 DD input end, with rag joint flange <i>- accepts 3/4 shaft with dust boot, addrag joint to box</i>	\$34.95
40-00SR	4" long 3/4 round input end, w/ rag joint flange end <i>- drill and pin to column shaft (recommend welding to shaft)</i>	\$34.95



BILL'S TRUCK SHOP LTD.

CHEV Est. 1987 GMC

40-90 PARTS & ACCESSORIES

PICTURE COMING SOON

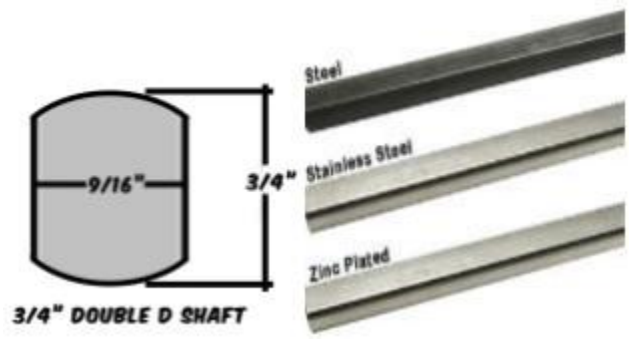

Part No.		Price
STEERING SHAFT U-JOINTS		
- when joining new columns to new steering systems (eg 3/4"-30 spline to double D shaft)		
- always drill a dimple in shaft where set screw seats		
41-0UJ1	- 9/16", 26 spline x 3/4" DD (mustang manual rack)	\$109.95
41-0UJ3	- 3/4", 30 spline x 3/4" DD	\$109.95
41-0UJ5	- 3/4", 36 spline x 3/4" DD	\$109.95
41-0UJ5-B	- 3/4", 36 spline x 3/4" DD - black	\$59.95
41-0UJ6	- 3/4" DD x 3/4" DD (mustang power rack)	\$109.95
41-0UJ7	- 1" DD x 3/4" DD	\$109.95
41-0UJ9	- 13/16", 36 spline x 3/4" DD	\$109.95
41-0UJ16	- 3/4", DD x 3/4" smooth	\$109.95
41-0UJ18	- 3/4", 36 spline x 1" DD	\$109.95
41-0UJ24	- 3/4" 30 spline x 1" DD	\$109.95
41-0UJ26	- 1" DD x 1" DD	\$109.95

STEERING RAG JOINT		
41-0RJ30	- 1" DD x 3/4 - 30 spline	\$134.95
41-0RJ36	- 3/4 - 36 x 11/16 - 36 spline	\$134.95
41-0RJ36 -3/4DD	- 3/4" DD x 11/16 - 36 spline	\$134.95
41-0RJ36 -1DD	- 1" DD x 3/4 - 36 spline	\$134.95
41-0RJ366 -1DD	- 1" DD x 11/16 - 36 spline	\$134.95
41-0RJ36-1DD	- 1" DD x 3/4 - 36 spline	\$134.95
41-0RJ10	- 1" DD x 3/4" DD	\$134.95

STEERING RAG JOINT (mini 2 7/8 OD)		
41-0RJ24-M	- 1 DD x 3/4 - 30 spline	\$114.95

DOUBLE STEERING U-JOINTS		
41-0DUJ6	- 3/4", 36 spline x 3/4" DD	\$199.95
41-0DUJ32	- 1" DD x 3/4" DD	\$204.95
41-00SS	Steering Shaft Support - 3/4" diameter	\$39.95



41-0UJ1



41-0UJ3

13/16-36

3/4-30



.790-.800



.720-.730



41-0RJ36



41-0DUJ6



41-00SS

Part No.		Price
SWAY BARS		
15-0550-K	63-87 Front Sway Bar Kit - with poly bushings, w/o brackets - 1 1/8" bar, 2WD trucks, correct OE Style	\$329.95
15-0550-K2	63-87 Front Sway Bar Kit - with poly bushings - 1 1/4" bar 2WD trucks, NEWER end link style, <i>special order</i>	\$324.95
FRONT SWAY BAR BRACKETS		
15-0550-FB	63-87 Front Sway Bar Brackets - w/ hardware, pair - for trucks with stock height suspension	\$39.95
15-0550-FBL	63-87 Front Sway Bar Brackets - w/ hardware, pair - for trucks lowered more than 3"	\$39.95
15-0549-RB	63-87 Front Sway Bar Brackets - w/ 1" bar, each	\$9.95
REAR SWAY BAR KIT		
16-07401-C	63-72 Rear Sway Bar Kit - w/ coil springs	\$289.95
16-0951-L	63-72 Rear Sway Bar Kit - w/ leaf spring, 7/8 bar	\$289.95
SWAY BAR BUSHINGS		
15-0549-PK	63-87 Sway Bar Bushing Kit - poly, w/ bkts & hdw, pair, 1"	\$39.95
15-0551-PK	63-87 Sway Bar Bushing Kit - poly, w/ bkts & hdw, pair, 1 1/16"	\$44.95
15-0550-PK	63-87 Sway Bar Bushing Kit - poly, w/ bkts & hdw, pair, 1 1/8"	\$42.95
15-0552-PK	63-87 Sway Bar Bushing Kit - poly, w/ bkts & hdw, pair, 1 1/4"	\$34.95
15-0549-R	63-87 Sway Bar Bushing - 1" rubber, each	\$11.95
15-0551	63-87 Sway Bar Bushings -poly / blue, pair, 1 1/16" - used for the original 1" wide retainers	\$34.95
15-0552	63-87 Sway Bar Bushings -poly / blue, pair, 1 1/4" - used for the original 1" wide retainers	\$34.95
15-0550	63-87 Sway Bar Bushings - poly / blue, pair, 1 1/8" - used for the original 1" wide retainers	\$34.95
FRONT COIL SPRINGS		
15-06372-S	63-87 Front Coil Springs - C10, SB or BB, stock height, pair	\$239.95
15-06372-1	63-87 Front Coil Springs - C10, SB or BB, 1" drop, pair	\$189.95
15-06372-2	63-87 Front Coil Springs - C10, SB or BB, 2" drop, pair	\$189.95
15-06372-3	63-87 Front Coil Springs - C10, SB or BB, 3" drop, pair	\$239.95

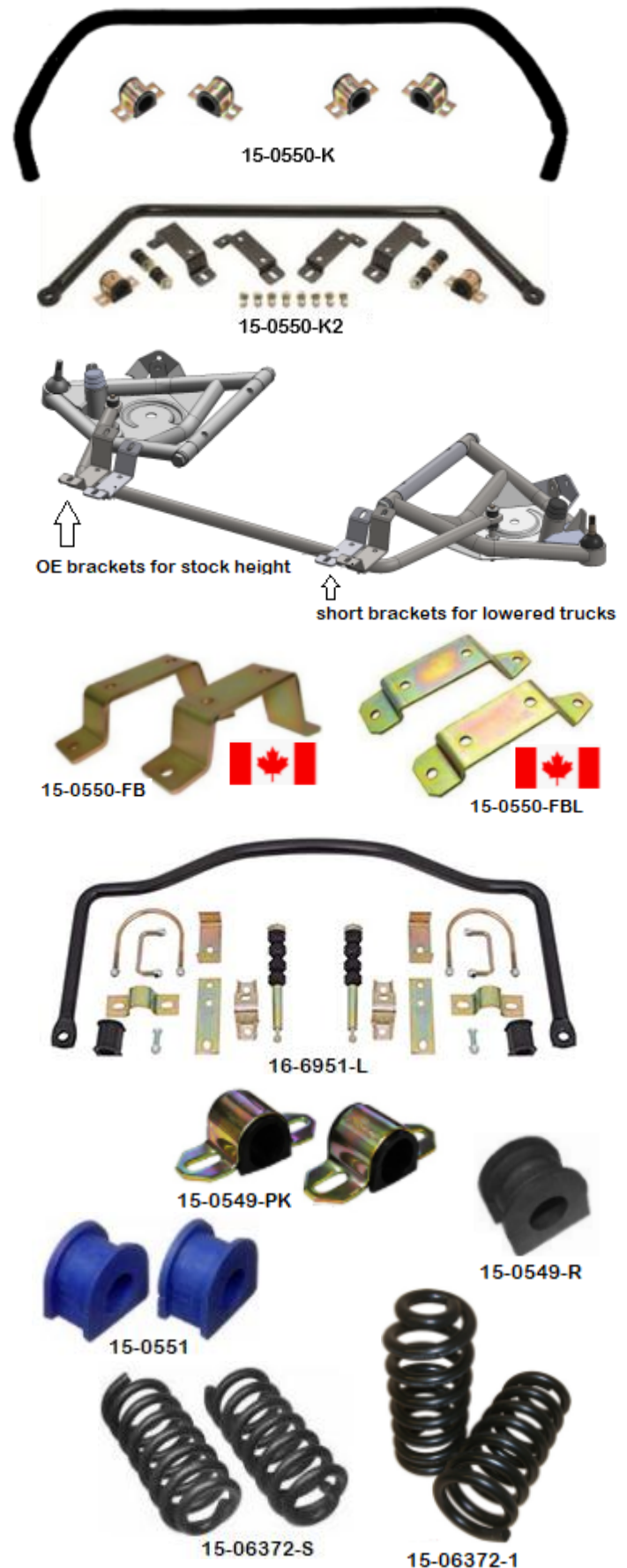

Part No.		Price
FRONT SHOCKS		
All shocks are gas pressurized		
15-0590	60-87 Shock Bolt - 1/2" thread, 9/16" collar, w/ hdw, each	\$9.95
15-0470	60-87 Shock Support Bolt - front upper, each	\$12.95
15-0471	60-87 Shock Bolt - lower, 1/2" x 2-1/2" w/ washer & nut, each	\$3.45
15-0FSR	63-91 Front Shock Relocator Kit - side frame mount	\$69.95
15-0FSR-T	63-91 Front Shock Relocator Kit - top frame mount	\$69.95
15-0039	63-91 Front Shock - front, each - stock height and/or lowered with 1" or 2" coils, C10 / 20.	\$62.95
15-0200	63-72 Front Shock - lowered 3", w/ coil springs each - extended 12 3/4" and 8 1/2" collapsed, add sleeves	\$69.95
15-0040	67-87 Front Shock - K10-20, stock height, each	\$89.95
15-0817	63-72 Front Shock - panel, suburban, 3/4 ton pickup - extended 12 3/4" and 8 1/2" collapsed, heavy duty application	\$74.95
REAR SHOCKS		
All shocks are gas pressurized		
16-0372-SRK	63-72 Rear Shock Relocator Kit - w/ coil spring only - used when rear suspension is lowered more than 3" correct shock angle, requires 2 #15-0590 shock bolts	\$124.95
16-0411-L	64-72 Rear Shock Bracket - lower, left	\$48.95
16-0412-R	64-72 Rear Shock Bracket - lower, right	\$48.95
16-0008	63-72 Rear Shock - w/ stock height, coil springs, each - also works on 2" to 4" drop coil or leaf springs	\$69.95
4X4 SUSPENSION & 2X2 (w/ rear leaf)		
16-0072-AL	60-87 Rear Axle Seats - replacement weld on, pair	Inquire
15-0036	69-87 Spring Shackle - rear, 1/2 ton, 2WD & 4WD, each	\$34.95
16-0372SK	63-72 Leaf Spring Shackle Kit - 2" drop, pair - fits 2 1/4" leaf springs, with polyurethane bushings	\$125.00



Part No.		Price
SPRING EYE BUSHINGS		
16-0083	67-87 Front Leaf Spring Eye Bushing - ½ ton 4WD, each - front of front spring, also fits 67-68 ¾ ton 4wd rear spring 1 ½ diameter	\$39.95
15-5459	69-87 Rear Leaf Spring Eye Bushing - C/10, each - 2 ¾ long x 1 ¼ OD & 9/16 ID of inner sleeve	\$29.95
15-0185	69-87 Rear Leaf Spring Eye Bushing - C/10, includes bolt, each - 2 ¾ long x 1 ¼ OD & 9/16 ID of inner sleeve, fits 1 x 1/2 spring eye at both ends	\$26.95
AXLE BUMPERS		
16-0875-L	64-87 Axle Bumper Rear - OE rubber type, each - C/K-10/20, bolt on to frame bracket.	\$21.95
16-0875-LP	64-87 Axle Bumper Rear - polyurethane type, each - C/K-10/20, bolt on to frame bracket.	\$24.95
16-0875-C	63-72 Rear Axle Bumpers - C-10 & 20, w/ coil springs, each - also fits rear bracket w/ leaf springs	\$14.95
REAR TRAILING ARMS		
Rear trailing arms are the same from 60-72 left or right, other than the park cable support bracket. Below has the correct 67-72 cable support, with poly bushings,		
16-ORTA-L	60-72 Rear Trailing Arms - C-10 & 20, left	\$389.95
16-ORTA-R	60-72 Rear Trailing Arms - C-10 & 20, right	\$389.95
17-0445	66-72 Park Cable Support - on trailing arm, w/ hdw, each	\$14.95
16-ORTA-1	60-72 Rear Trailing Arm Set - pair - square tube design w/ bushings	Inquire
REAR TRAILING ARM BUSHINGS		
16-0285	60-72 Rear Trailing Arm Bushing - original type, each	\$24.95
16-0285-PK	60-72 Rear Trailing Arm Bushing - polyurethane, kit	\$49.95
29-0285-B	60-72 Rear Arm Bushing Bolt - w/ hardware, 4' x 3/4" each	\$9.95
16-0228	60-72 Rear Axle U-bolt - 9 ½" long, w/ hdw, C-10 & 20, each	\$34.95
16-0228-13	60-72 Rear Axle U-bolt - 13" long, w/ hdw, C-10 & 20, each - when using additional drop blocks, w/ 4" of threaded end	\$39.95
16-0072-AS	60-72 Rear Axle Seats - pair - replacement weld on seats from trailing arm w/ 3" axle tube	\$79.95



Part No.		Price
TRACK BARS		
16-072ATB	65-72 Adjustable Track Bar - C10, 22" to 24" - w/ poly bushings	\$119.95
TRACK BAR BUSHINGS		
16-0280-C10	60-72 Track Bar Bushing - original rubber, C10, each	\$26.95
16-0280-C20	65-72 Track Bar Bushing - original rubber, C20, each	\$64.95
16-0280-PK	60-72 Track Bar Bushing Kit - polyurethane, ½ ton	\$39.95
16-0280-20PK	60-72 Track Bar Bushing Kit - polyurethane, ¾ ton	\$24.95
16-04TS	65-72 Track Bar Axle Stud - w/ hdw	\$55.00
16-04TB	65-72 Track Bar Bolt - at frame, C-10 & 20	\$3.95
C-NOTCH KIT		
Supports to allow for more axle clearance on lowered trucks with coil springs. With the upper plate bolted in place, it not only keeps your frame straight and sag free, but it also acts as the template for where you need to cut your frame.		
16-0CNK	63-72 Rear Axle C-Notch Kit - complete, US MADE	\$194.95
REAR END CONVERSION TRAC BAR		
16-0021-A	63-72 Deluxe Rear End Conversion Trac Bar Kit - bent bar - Secures to right trailing arm. Ideal for trucks lowered more than 4" with poly bushings. No welding required. Bent bar added for more axle cover clearance.	\$239.95
16-0021	65-72 Deluxe Rear End Conversion Trac Bar Kit - straight bar - Secures to right trailing arm. Ideal for trucks lowered more than 4" or adding later style rear ends with poly bushings. No welding required.	\$204.95
16-072RCK	63-72 Rear End Conversion Trac Bar Kit - 73 & up rear end - Allows you to install any 3" tube rear end (73 & up) that is 61" wide. Includes weld on trailing arm seats and adjustable track bar with weld on brackets.	\$249.95
COIL SPRING RETAINERS		
16-0511	60-72 Rear Coil Spring Retainer - upper & lower, each	\$14.95
16-0510-S	63-72 Rear Upper Coil Spring Frame Seat - w/ hdw, each	\$39.95
16-0511-K	60-72 Rear Coil Spring Retainer Kit - 4 retainers, w/ bolts	\$74.95
16-0512-L	60-72 Rear Coil Retainer Lower Bolt - w/ hdw, 5" x 1/2", each	\$3.95
16-0512-U	60-72 Rear Coil Retainer Upper Bolt - w/ hdw, each	\$2.25



Part No.		Price
16-0472-A	63-72 Front Frame Brace - C/K 10/20, 2 & 4WD	\$224.95
16-0472-B	63-72 Front Engine Crossmember - with 1/2 ton upper control arm supports	\$3381.95
16-0472-C	63-72 Transmission Support - 3pc kit	\$279.95
16-0472-E	63-72 Center Frame Brace - rear coil spring truck - with upper shock and drive shaft support	\$994.95
16-0472-D	63-72 Frame Brace - rear coil spring truck - with shock brackets and upper spring seats	\$229.95
16-0472-F	63-72 Frame Brace - rear coil spring truck - with trac bar support	\$275.95
16-0472	63-72 Rear Frame Cross Brace - w/ hdw, MADE IN CANADA - replacement for your removed or damaged one	\$99.95
16-0472-G	63-72 Rear Frame Cross Brace - OE style	\$275.95
16-5SBR-L	67-72 Frame Rail - short bed 115" frame 2WD, left w/ factory brace supports & crossmember holes	\$2250.00
16-5SBR-R	67-72 Frame Rail - short bed 115" frame 2WD, right w/ factory brace supports & crossmember holes	\$2250.00
16-5SBF	67-72 Short Bed Frame - complete	\$5999.95



16-0472-A



16-0472-B



16-0472-C



16-0472-E

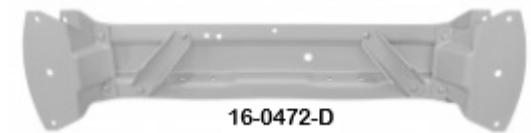

16-0472-D



16-0472-F



16-0472-G

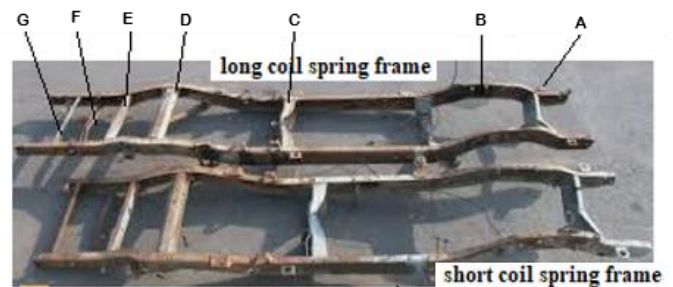

long coil spring frame

short coil spring frame

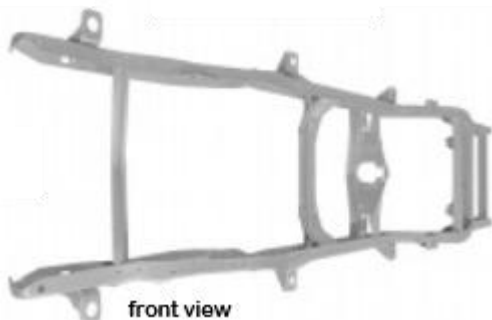

front view



back view

16-5SBF



16-5SBR-R

Part No.		Price
REAR COIL SPRINGS		
16-06072-S	60-72 Rear Coil Springs - stock height, C-10, pair	\$279.95
16-06072-S-HD	60-72 Rear Coil Springs - stock height, C-20, pair - also fits 1/2 & 3/4 ton suburban	\$289.95
16-0603-2HD	60-72 Rear Coil Springs - 2" drop, C-10, used for towing, etc. - heavy duty application, fits pick-ups, panels & suburban's	\$199.00
16-0603-3	60-72 Rear Coil Springs - 3" drop, C-10, pair	\$189.00
16-0603-4	60-72 Rear Coil Springs - 4" drop, C-10, pair	\$189.00
16-0603-5	60-72 Rear Coil Springs - 5" drop, C-10, pair	\$189.00
REAR LOWERING BLOCKS		
When ordering blocks (aluminum). Check length of U-bolt thread available.		
16-0CP4-1	60-72 Rear Lowering Block Kit - 1", w/ U-bolts	\$119.95
16-0CP4-2	60-72 Rear Lowering Block Kit - 2", w/ U-bolts	\$119.95
AUXILIARY REAR LEAF		
16-0827	64-72 Auxiliary Rear Leaf Spring Kit - complete w/ hdw - used on rear coil spring to carry heavier loads	Inquire
16-0827-B	64-72 Auxiliary Spring Bumper, each	\$10.95
PINION ANGLE SHIM		
16-0RPS-4	60-72 Pinion Angle Shim - 4 deg, aluminum, pair - with coil rear springs	\$64.95
16-0RPS-2	60-72 Pinion Angle Shim - 2 deg, aluminum, pair - with coil rear springs	\$54.95
SPIDER GEAR SET		
16-0717	Spider Gear Set - w/ 30 spline axles, 8.875 gear	\$245.95
WHEEL STUDS		
38-0230-S	51-70 Wheel Stud - 1/2 ton, 7/16-20 x 1 3/8", each - also fits 63-70 4x4	\$3.95
16-0138-S	71-72 Wheel Stud - 1/2 ton, 2x2, 1/2-20, each	\$4.95
16-5232-S	71-72 Wheel Stud - 1/2, 4x4, each	\$5.95

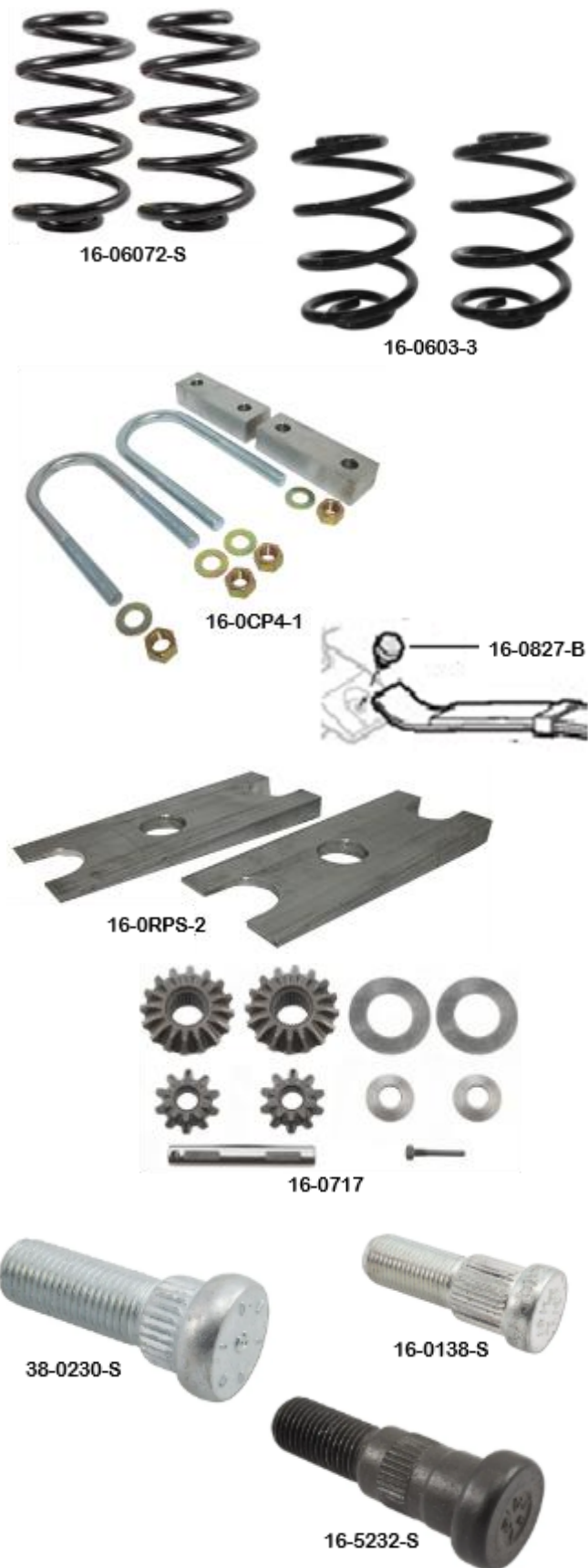

Part No.		Price
REAR AXLES		
	67-69 Rear end backing plate inside distance = 56"	
	70-70 Rear end backing plate inside distance = 57"	
When changing to 5 stud axles, add 71-72 drums. Please inquire for more details		
16-039RAC-5	65-69 Rear Axles Conversion Kit - to 5 stud, pair - 30 3/4" long flange out, 30 spline, requires 1/2" dia wheel studs #16-0138-S & #17-0187 drums.	\$595.95
16-57070-A5	70-70 Rear Axles Conversion Kit - from 6 to 5 stud, pair - 31 1/2" long flange out, 30 spline, requires 1/2" dia wheel studs #16-0138-S	\$549.95
16-0690	65-69 Rear Axle - 6 stud, 1/2 ton, each	\$189.95
16-0181-2WD	71-81 Rear Axle - 2WD, 5 stud, left or right, each - 31-15/16 long, 30 spline, 12 bolt rear end	\$169.00
16-0750	70-81 Rear Axle - 4WD, 1/2 ton, 6 stud, left or right, each - 12 bolt, 8.875 ring gear, 30 spline	\$189.95
REAR AXLE BEARING		
16-0559	63-91 Rear Axle Bearing - outer, C-10, 2- & 4-wheel drive	\$29.95
16-0560	63-81 Inner Axle Bearing - 1/2 ton, 8.875 ring gear, w/o race - also fits 67-81 3/4 ton	\$26.95
REAR AXLE SEALS		
16-0044	65-79 Rear Axle Seal - C10, with semi floating axle - also fits 80 - 91 truck with 8.5" & 8.875" ring gear	\$9.95
16-0190	64-81 Pinion Seal - 12 bolt, C10, GM 8.875 ring gear	\$24.95
-Dana rear axle covers have straight sides. Other axles have a round cover		
16-0192	64-81 Rear Axle Cover Gasket - 12 bolt, C-10	\$18.95
41-0088	47-72 Rear Cover Gasket - 10 bolt, 3/4, 1 & 1 1/2 ton - H072-52 Eaton	\$21.95
41-081B	47-72 Rear Axle Seal - 3/4 ton, w/o Dana rear axle	\$24.95
REAR AXLE VENTS		
16-0270-K	60-87 Rear End Vent Hose - w/ vent	\$11.95
16-0270	47-72 Rear End Vent - 350 trans vent, w/ cover	\$2.50
REAR PINION CRUSH SLEEVE		
41-0152	66-81 Sleeve - 1/2 ton, with 8:75 rear end	\$16.50





Part No.		Price
BRAKE RETURN SPRING KITS		
17-0017	64-70 Front Brake Spring Kit - C/K-10/20 - hold down, return & adjuster spring	\$19.95
17-0018	64-75 Rear Brake Spring Kit - C/K-10, w/ 11 x 2" brakes - hold down, return & adjuster spring	\$19.95
17-5225	69-72 Rear Brake Spring Kit - C/K-20, w/ 12" brakes - hold down, return & adjuster spring	\$34.95
17-0027	65-74 Brake Spring Kit C/K-20/30	\$24.95
BRAKE ADJUSTER KIT		
Fits 64-75, 1/2 - 3/4-ton REAR , 2 & 4-wheel drive, 64 1/2 ton, 2-wheel drive FRONT , and 65-75 1/2 ton 2 & 4-wheel drive FRONT . Can use to upgrade to self adjusting brakes from 60-63.		
17-0508	64-75 Brake Adjuster Kit - C/K-10/20, w/ 11" brakes, left	\$29.95
17-0509	64-75 Brake Adjuster Kit - C/K-10/20, w/ 11 brakes, right	\$29.95
PARK BRAKE ARM & SPRINGS		
17-0507	Brake Adjust Arm Return Spring - each	\$3.95
37-0744	51-87 Park Brake Bar Spring - at cross bar & front shoe	\$2.95
37-0745	51-77 Park Brake Bar - 1/2 ton, approximately, 7 1/2" long	\$11.95
17-0701	64-91 Park Brake Cable Arm - 1/2 ton, left	\$34.95
17-0702	64-91 Park Brake Cable Arm - 1/2 ton, right	\$34.95
17-0444	60-91 Park Brake Arm Retainer Clip - w/ tension washer, 2 pair	\$3.00
17-0444-SK	64-91 Park Brake Arm Stud & Clip Kit - 6pcs	\$9.95
BRAKE SHOES		
17-0280	64-70 Front & 64-76 Rear Brake Shoes - 11" x 2", C/K-10, set	\$59.95
17-0280-P	64-70 Front & 64-76 Rear Brake Shoes - 11" x 2", premium - premium brand, riveted linings	\$99.95
17-0248R	60-70 Brake Shoes - front & rear, riveted, 11 5/32" x 2 3/4", C20 - linings are riveted on	\$89.95
17-0248B	60-70 Brake Shoes - front & rear, bonded, 11 5/32" x 2 3/4", C20 - linings are bonded on	\$84.95
17-0127	64-70 Rear Brake Shoe Set - 12 x 2 1/2, C-20 & 30 - also fits 71 w/ rear leaf springs	\$87.95
37-0330	64-70 Brake Shoe Set - 12 x 2 3/4 ton & 4x4 front & rear - bonded	\$79.95
SUBURBAN & PANEL BRAKE SHOES		
17-0227	67-70 Front Brake Shoe Set - 1/2 ton, 11 5/32 x 2 3/4 - premium brand bonded	Inquire



17-0017



17-5225



17-0508



37-0745



37-0744



17-0701

17-0702



17-0280-P



17-0127



17-0227

Part No.		Price
PARK BRAKE ASSEMBLY		
17-5445-K	69-72 Park Brake Assembly - C-10 & 20	\$269.95
17-5445-K-S	69-72 Park Release Handle Spring - each	\$9.95
FRONT BRAKE CABLE		
17-0410-P	60-68 Cable Retainer Pin - w/ cotter pin	\$2.00
17-0525-R	60-68 Park Cable Retainer - clamp, w/ bolt & cable clevis pin	\$14.95
17-525-R	69-72 Park Cable Retainer - clamp, w/ bolt & cable clevis pin	\$14.95
17-0449	66-68 Front Park Cable - w/ pull brake lever, C-10 & 20	\$59.95
17-0409	66-68 Front Park Cable - w/ pull brake lever, K-10 & 20	Inquire
17-5410	69-72 Front Park Cable - K-10 & 20, approx. 84" long - with return spring eyelet in threaded end	\$69.95
17-5432	69-70 Front Park Cable - long bed, C-10 & 20 - with push brake pedal	\$52.95
17-5432-SB	69-72 Front Park Cable - short bed, C-10 - also fits 71-72 long bed, with push brake pedal	\$54.95
INTERMEDIATE CABLES & CONNECTOR		
17-0500A	47-87 Adjustable Cable - SHORTENER, each	\$13.95
17-0500-K	66-72 Brake Cable Guide Connector Kit - 6 pcs - application is for 2-wheel drive. Modify right rod for 4x4.	\$42.95
17-0500-G	66-72 Park Cable Guide - secures cable at frame, pair	\$12.95
17-0805-R	65-72 Intermediate Cable Rod - w/ cable guide	\$10.00
17-0805	66-72 Intermediate Cable Equalizer - front cable, left	\$21.95
17-0500-C	65-72 Rear Cable Connector - each	\$8.95
17-0596	66-72 Intermediate Cable - w/ 127 wheelbase, 118 1/2" long - w/o 400 trans	\$21.95
17-0443	66-72 Intermediate Cable - w/ 115" wheelbase, 95" long - w/o 400 trans	\$21.95
For a universal intermediate cable, see long or short cable and add 17-0339 cable lock stop		
17-0339	Cable Lock Stop - w/ 1/8 cable, each	\$4.95
17-5520	67-72 Intermediate Cable Guides - pair, w/ 400 trans - on crossmember	\$10.00
17-0102-C	55-87 Intermediate Cable Retainer - clip, pair	\$5.95
17-0519	66-72 Park Cable Guide Bushing - in frame cross member, pair - original OE nylon	\$8.95

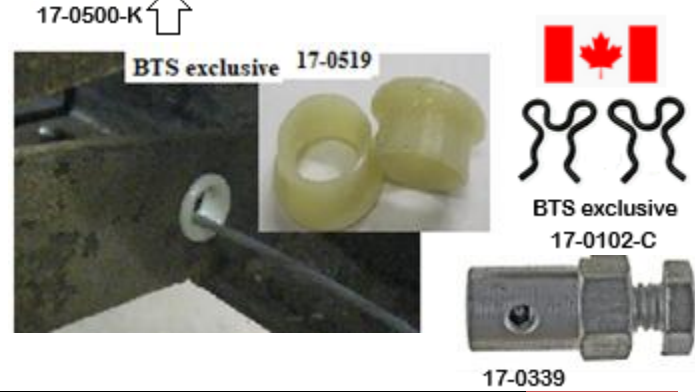
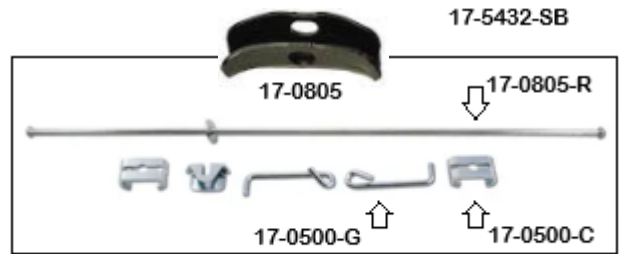
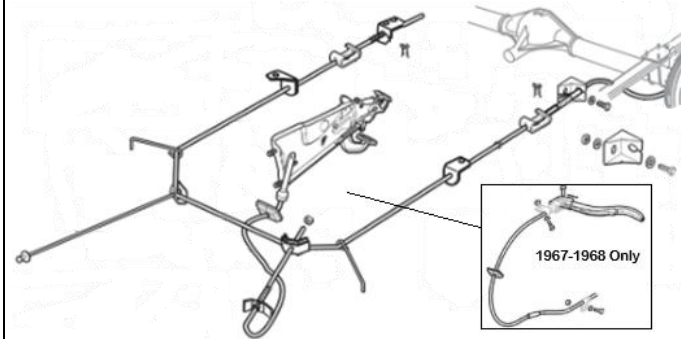

Part No.		Price
REAR BRAKE CABLE		
17-0112	Universal Rear Park Cable Kit - bolts to backing plate, cut to fit - casing length 70", cable length 93"	\$64.95
17-0700	Universal Rear Park Cable - w/ hdw - great for nonstock application	\$62.95
17-0416	66-72 Rear Brake Cable - C-10, w/ coil rear springs, each	\$39.95
17-5838	67-72 Rear Brake Cable - C-10, w/ leaf rear springs, each	\$79.95
17-5421	68-72 Rear Brake Cable - C-20, 2WD, w/ leaf springs, each - total length 42", casing 29", bolts to backing plate	\$52.95
17-5422	69-70 Rear Brake Cable - C-20, w/ leaf springs, each - cable length 51", 133" wheelbase	\$89.95
17-5448	67-72 Rear Brake Cable - K-10, 4WD, each - approximately 48" long	\$89.95
17-0056	64-72 Rear Brake Cable - K-20, 4WD, each - cable 49", casing length 35", bolts to backing plate, may require moving frame bracket.	\$99.95
BRAKE DRUMS		
37-0217	51-70 Brake Drum - front & rear, 1/2 ton, 11 x 2, C/K-10, each	\$79.95
17-0187	71-87 Brake Drum - rear, 11 x 2, C-10, each	\$79.95
17-0037	71-75 Brake Drum - rear, 11 x 2, K-10, 4x4, 6 stud, each	\$109.95
17-5203	67-70 Brake Drum - rear, 3/4 ton, 11 5/32 x 2 3/4 - without dana rear axle, with coils	Inquire
17-0739	69-70 Brake Drum - front, 11 1/16 x 2 3/4, 6 stud - suburban & panel with HD brake option	Inquire
DISC BRAKE CALIPER		
17-0CORE	Caliper Core Charge - without return	\$26.50
17-0100-R	71-78 Brake Caliper - right, w/ 7/16 banjo bolt & hdw - fits 1/2 ton, to 1 ton, 2WD	\$89.95
17-0100-L	71-78 Brake Caliper - left, w/ 7/16 banjo bolt & hdw - fits 1/2 ton, to 1 ton, 2WD	\$89.95
Below calipers are not for 1971 - 1978 OE brake systems		
17-0527U	79-87 Brake Caliper - right, w/ HD spindle & hdw	\$89.95
17-0526U	79-87 Brake Caliper - left, w/ HD spindle & hdw	\$89.95



Part No.		Price
BRAKE PAD		
17-0MD52	71-87 Brake Pads - semi metallic pads, set	\$32.95
17-0408	71-87 Brake Pad Retainer - each	\$2.50
FRONT WHEEL CYLINDERS		
17-0025	64-70 Wheel Cylinder - front, left, C10	\$29.95
17-0026	64-70 Wheel Cylinder - front, right, C10	\$29.95
37-0203-FL	64-69 Wheel Cylinder - front, left, K10	\$39.95
37-0204-FR	64-69 Wheel Cylinder - front, right, K10	\$39.95
17-0086	63-70 Wheel Cylinder - C-20/30, 1 1/8" bore, front, left - for 11 5/32" x 2 3/4" shoes, also fits 63-70 C-10 suburban, panel	\$69.95
17-0087	63-70 Wheel Cylinder - C-20/30, 1 1/8" bore, front, right - for 11 5/32" x 2 3/4" shoes, also fits 63-70 C-10 suburban, panel	\$69.95
REAR WHEEL CYLINDERS		
37-0303-RL	55-72 Wheel Cylinder - C/K-10, rear, left	\$29.95
37-0303-RR	55-72 Wheel Cylinder - C/K-10, rear, right	\$29.95
17-0474	64-72 Wheel Cylinder - C/K-20/30, 1 1/8" bore, rear, left - with leaf spring dana rear end, 133" wheelbase	\$76.95
17-0475	64-72 Wheel Cylinder - C/K-20/30, 1 1/8" bore, rear, right - with leaf spring dana rear end, 133" wheelbase	\$76.95
17-0040	64-72 Wheel Cylinder - C-20/25, 1 1/8" bore, rear, left - with coil springs, without dana rear end	\$52.95
17-0039	64-72 Wheel Cylinder - C-20/25, 1 1/8" bore, rear, right - with coil springs, without dana rear end	\$52.95
37-0050	60-72 Wheel Cylinder Push Rod - each	\$6.95
17-0402	Wheel Cylinder Bleeder Screw - 3/8- 3/8- 24, each	\$1.65
WHEEL CYLINDER REBUILD KIT		
17-0036	Wheel Cylinder Rebuild Kit - 1 1/8 " bore	\$20.95
17-0046	Wheel Cylinder Rebuild Kit - 1" bore	\$11.50
37-0054	Wheel Cylinder Rebuild Kit - 1 1/4" bore	\$24.95
37-0038	Wheel Cylinder Rebuild Kit - 1 3/8" bore	\$34.95
37-0051	51-87 Brake Shoe Guide Plate - each	\$9.95



Part No.		Price
FRONT BRAKE HOSES		
17-5592	67-70 Brake Hose - C-10/20, left or right, each	\$24.95
17-5224	68-70 Brake Hose - K-10/20, (25" long) - requires nut #37-0766 to secure to frame	\$39.95
17-5712-C10-L	71-72 Brake Hose - C-10, w/disc brakes, left	\$39.95
17-5712-C10-R	71-72 Brake Hose - C-10, w/disc brakes, right	\$39.95
17-5712-C20	71-72 Brake Hoses - C-20, left or right, pair - 9 1/2 crimp to crimp, total length 13 1/2"	\$47.95
17-5761	71-72 Brake Hose - K-10/20, left or right, each	\$46.95
Original drum brake flex hoses mount behind the upper control arm. 79-80 flex hoses can be used when converting to disc brakes. Secures in oval hole in frame in front of upper control arm and has bracket to secure hose to upper control arm.		
17-6712	79-80 Brake Hose - use 17-0699 banjo bolt, right	\$39.95
17-6713	79-80 Brake Hose - use 17-0699 banjo bolt, left	\$39.95
REAR BRAKE HOSES		
17-5542	67-70 Brake Hose - C-10/20, w/ coil springs, 18 1/2" long, each	\$32.95
17-5564	68-70 Brake Hose - C-10/20, w/ leaf springs, 19 1/4" long, each - also fits 68-70 K-20 with leaf springs	\$55.95
17-5683	71-72 Brake Hose - C-10 pickup, 2 & 4WD drive. 20 1/2" long - also fits C-10 suburban, 3/4-ton 4wd, w/ block fitting on end	\$39.95
37-0248	38-70 Rear Flex Hose Splitter Block - each - 7/16-20 on one side and 3/8-24 on the other 2 sides, secures to diff housing bracket with clip	\$29.95
37-0471	"T" union - 3/8-24, 3/16 line, pipe, each	\$6.95
37-0215-C	Brake Hose Retainer - each	\$1.65
37-0766	Flex Hose Nut - secures to frame - each	\$1.25
37-0243	Brake Hose Gasket - 7/16 ID	\$3.25
37-0795	Brake Hose Gasket - 3/8 ID	\$1.25
BRAKE LINE RETAINER		
17-0316	Brake Line Retainer - 3/16" line, silver colour, pair	\$4.95
17-0125	Brake Line Retainer - 1/4" line, light blue colour, pair	\$5.95

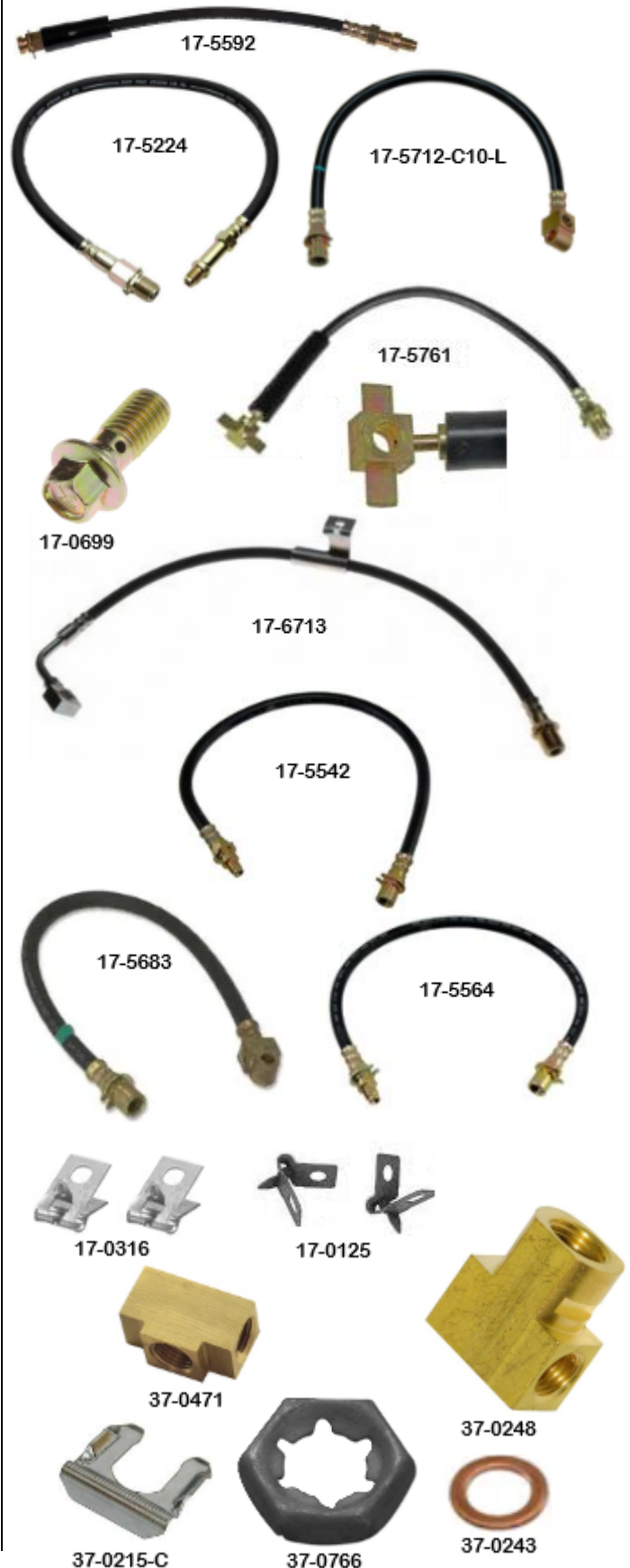

Part No.		Price
BANJO BOLT		
17-0699	Banjo Bolt - 10 x 1.5 - 1 3/8, each	\$6.95
17-0700-B	Banjo Bolt - 10 x 1.5 - 1 7/16, each	\$5.95
17-0698	Banjo Bolt - 7/16" x 20 -1 3/4, each	\$9.95
DISC BRAKE ROTOR		
17-0537	71-87 Disc Brake Rotor - C10, 5 stud, each	\$119.95
17-0050	71-91 Disc Brake Rotor - C20, 3/4, 1 ton and up, each	\$169.95
17-04R-6	60-70 Disc Brake Rotor - 6 stud. each	\$139.95
DUST SHIELDS		
17-0800-DC	71-87 Dust Shields - for front rotor, C10, 2x2, pair	\$119.95
SPINDLE NUT & DUST CAPS		
15-0193	63-87 Spindle Nut - washer & cotter pin	\$14.95
17-0977	47-87 Spindle Dust Cap - 2 3/32" ID, each	\$9.95
17-0977-K	64-87 Spindle Dust Cap Kit - 2 3/32" ID, large size, 2 sides - with nut, washer, cotter pin	\$29.95
17-0978	71-87 Spindle Dust Cap - 1 25/32" ID, each	\$3.50
17-0978-K	71-87 Spindle Dust Cap Kit - 1 25/32" ID, small size, 2 sides - with nut, washer, cotter pin	\$24.95
WHEEL BEARING		
17-0BR5	62-98 Wheel Bearing - inner, 1/2 ton, each	\$23.95
17-0BR2	62-70 Wheel Bearing - outer, 1/2 ton, each	\$14.95
17-0BR3	71-80 Wheel Bearing - outer, 1/2 ton, each	\$19.95
17-0777	63-70 Wheel Bearing - front inner, w/o outer race, 3/4 ton, each	\$69.95
HUB SEAL		
15-0757	62-70 Front Hub Seal - 1/2 ton, each	\$27.95
17-0984	71-91 Front Hub Seal - w/ disc brakes, 1/2 ton, each	\$6.95
17-0771	63-91 Front Hub Seal - 3/4 & 1 ton, each	\$11.95
17-0898	60-72 Front Hub Seal - 4x4, 1/2, w/ drum or disc brakes. each	\$13.95

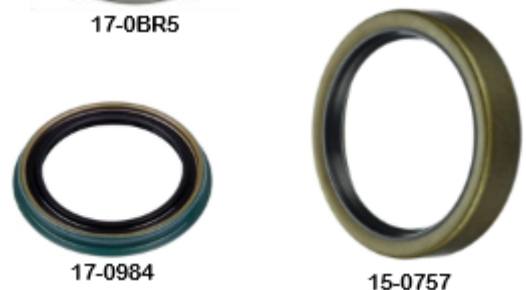

Part No.		Price
BRAKE BOOSTER		
	Firewall mount for Bendix is shorter than Delco booster	
17-56772-BB	67-72 Brake Booster - 11", w/ mount bracket & hdw	\$289.95
17-56772-B	67-72 Brake Booster - 11", w/o mount bracket, Delco Moraine	\$189.95
17-56772-BR	67-72 Brake Booster - rebuilt, 11", w/o mount bracket - Delco Moraine, OE replacement, requires OE core	\$189.95
17-56772-A	67-72 Brake Booster - w/o mount bracket, 3/4 Bendix - OE replacement	\$189.95
7-0451-R	63-72 Clip - pin retainer, brake push rod	\$7.95
7-0452	63-72 Brake Rod Pin - w/ tension washer & cotter pin	\$2.00
17-56772-BK	67-72 Brake Booster Kit - disc / drum - w/ mount bracket, master cylinder & disc / drum prop valve	\$499.95
17-56772-DBK	67-72 Brake Booster Kit - w/ 4-wheel drum brakes only - w/ mount bracket, master cylinder	\$399.95
17-56772-BK-C	67-72 Brake Booster Kit - chrome - w/ mount bracket, master cylinder & disc / drum prop valve	Inquire
17-56772-K	67-72 Booster Support Bracket - includes hiem joint & boot - for flat style booster	\$119.95
17-04SRB-DP	Power Booster Pins - 2 3/8 " long	\$6.00
17-04SRB-SP	Power Booster Pins - 4" long	\$6.00



CHECK VALVE & VACUUM PORTS

17-0BV-B	Brake Booster Check Valve - black, w/ hdw	\$15.95
17-0BV-G	Brake Booster Check Valve Grommet - each	\$7.95
17-0VP-1	Intake Vacuum Fitting - 1 3/8" intake port hose fitting - for power brakes	\$29.95
17-0VP-2	Intake Vacuum Fitting - 2 port T fitting, 3/8" intake hole - for power brakes & auto trans	\$29.95
17-0VP-3	Intake Vacuum Fitting - 3 port fitting, 3/8" intake hole - for power brakes, auto trans & AC	\$39.95



Part No. **Price**

MASTER CYLINDERS

Always confirm master cylinder push rod bore depth. All manual have 1 1/2" deep bore.
Power boosters can have 1 1/2" to 1 3/8" deep bore.

17-0C100-L	Dual Master Cylinder - disc/drum application, 1" bore - corvette style, manual or power brakes, 1/2-20 & 9/16-18 port, add #17-0015 spacer for shallow bore.	\$89.95
17-0505	67-70 Master Cylinder - w/ drum brakes, C-10, 1" deep bore -screw on lid	\$109.95
17-5246	67-70 Master Cylinder - w/ drum brakes, w/ 1 1/8 bore OD - 3/4 ton & up,	\$159.95
17-5461	67-72 Master Cylinder - C/K-20, 1 1/8" bore (Bendix) - OE style, manual or power brakes, 1 3/8" deep push rod bore	\$124.95
17-5494	71-72 Master Cylinder - C/K-10, 1 1/8" bore (Delco-moraine) - OE style, with power brakes, 1 3/8 deep push rod bore	\$159.95

17-0015	Master Cylinder Bore Spacer - 1 1/2" long	\$4.95
----------------	---	---------------

PROPORTIONING VALVE

17-0PVKS-2	Brake Proportioning Valve - disc/drum, w/ lines - used when converting to disc brake	\$149.95
17-0PVKS-4	Brake Proportioning Valve - disc/disc, w/ lines - used when converting to disc front and rear	\$149.95
17-0PVKS-A4	Brake Proportioning Valve - disc/disc, w/ lines, aluminium - used when converting to disc front and rear	\$159.95
17-0PV-S	60-72 Proportioning Valve Line Set - pair - front fitting 1/2-20 & rear 7/16-24 (left-outer side on master, top on prop valve)	\$14.95
17-0PV	60-70 Distribution Valve - w/ drum-drum dual master - w/ light switch	\$104.95
17-0PVK-H	Harness - prop valve switch	\$12.95

REAR DISC BRAKE KIT

Inquire about complete front disc brake 5 stud & 6 stud with stock or drop spindles.

17-071-RD-5	71-87 Rear Disc Brake Kit - upgrade to disc brakes, 5 stud - includes rotors, callipers, lines, cables, brackets & hardware, will require disc/disc prop valve	Inquire
17-071-RC	71-87 Rear Emergency Brake Cables - pair - with disc brakes	Inquire
17-071-RD-6	63-70 Rear Disc Brake Kit - upgrade to disc brakes, 6 stud - includes rotors, callipers, lines, cables, brackets & hardware, will require disc/disc prop valve	Inquire
17-063-RC	63-70 Rear Emergency Brake Cables - pair - with disc brakes	Inquire



Part No.		Price
ELECTRIC FAN		
	<ul style="list-style-type: none"> • Curved blades are quiet and push the same amount of air as a straight blade. • Factory built as a puller, mounted inside and pulls the air through the radiator. • 12V reversible blade & the polarity of the wiring can be reversed to push or pull. 	
44-0012	- 12" wide, 870 CFM, 12V reversible	\$89.95
44-0014	- 13.82" wide, 2.58" deep, 1750 CFM, 12V, 90W reversible	\$99.95
44-0016	- 16" wide, 3.75" deep, 2300 CFM	\$99.95
FAN CONTROL		
44-0016-R	Electric Fan Control - adjustable, w/ thermostat. - allows the installer to set what engine temperature to power up your electric cooling fan.	\$42.95
44-0016-S	Electric Fan Control - w/ thermostat - powers up electric fan when motor reaches 185 F and powers down when motor reaches 170 F	\$64.95
44-0016-SD	Dual Fan Relay Kit - w/ temp sender, relays, fuse, wiring - on at 195 F and shuts off at 180 F.	\$114.95
ELECTRIC FAN SHROUD		
18-510-AD	Electric Fan Shroud -, w/ dual electric fan holes, 14" fans - brushed aluminum, secures to the upper and lower rad braces	\$139.95
18-510-AS	Electric Fan Shroud - w/ single electric fan hole, 16" fan - brushed aluminum, secures to the upper and lower rad braces	\$139.95
FAN SHROUDS		
	8cyl fan shroud upper brackets are 28 1/2" apart. 6cyl are 26 3/4" apart.	
18-511-6	67-72 Fan Shield - 6cyl	Inquire
18-511-G	67-72 Fan Shield Bumpers - on fan shield to rad, pair	\$3.00
18-510	67-72 Fan Shroud - C-10/20, 8cyl, w/o A/C	\$169.95
18-510-AC	67-72 Fan Shroud - C-10/20, 8cyl, w/ A/C	\$169.95
18-510-K	67-72 Fan Shroud - K-10/20, 8cyl	\$289.95
18-510-BB	68-72 Fan Shroud - C-10/20, Big Block, plastic, V8	\$299.95
19-0352	68-72 Fan Shroud Lower Retainer Clip - pair	\$2.00
18-510-SK	67-72 Fan Shroud Upper Bracket Screw Kit - 4pcs	\$5.95
18-0510-R	67-84 Fan Shroud Lower Retainers - BTS exclusive, pair - replaces GM# 3967379	\$19.95
RADIATOR COVER PLATE		
18-525	67-72 Radiator Cover Plate - 16gauge, 28 L x 2 3/4 W, pair - mirror finish, stainless steel, secures between the 2 upper rad retainer cushions, no hdw required	\$53.95



Part No.		Price
RADIATORS		
The aluminum rad require the upper & lower rubber seats to be reshaped to accommodate the SQUARE tanks. They all use 3 row rad retainers and rubbers		
18-520-3A-A	67-72 Radiator - aluminum, V8, auto, w/ trans cooler - high efficiency, 3 row cores for maximum cooling. Core size is 28 1/2" x 19 1/2". Inlet is 1 1/2". Outlet is 1 3/4" curved up with heater hose outlet in tank. Accepts 10-516-K pads & retainers.	\$424.95
18-520-3A-ALS	67-72 Radiator - aluminum, V8, LS engine, w/o trans cooler - high efficiency, 3 row cores for maximum cooling. Core size is 28 1/2" x 19 1/2". Inlet is 1 1/2". Outlet is 1 3/4" curved up with heater hose outlet in tank. Accepts 3" pads & retainers Accepts 10-516-K pads & retainer kit. Add outlets as required, (1 1/4" or 1 1/2")	\$499.95
18-0125	Outlet - screw in, 1 1/4" OD	\$59.95
18-0150	Outlet - screw in, 1 1/2" OD	\$59.95
18-520-3A-AM	67-72 Radiator - aluminum, V8 w/ manual transmission - high efficiency, 3 row cores for maximum cooling. Core size is 28 1/2" x 19 1/2". Inlet is 1 1/2". Outlet is 1 3/4" curved up with heater hose outlet in tank. Accepts 3" pads & retainers.	\$424.95
18-520-3A-A6	67-72 Radiator - aluminum, 6cyl, auto, w/ trans cooler - high efficiency, 3 row cores for maximum cooling. Core size is 26 1/2" x 19 1/2". Inlet is 1 1/2". Outlet is 1 3/4" curved up. Accepts 10-516-K pads & retainers.	\$424.95
18-520-4A	67-72 Radiator - heavy duty, 4 row, auto w/ trans cooler - plastic / aluminum	\$495.00
RAD RETAINERS & PADS		
10-515-K	67-72 Radiator Retainer Kit - light duty rad, 2 & 3 row core - 4 pads, 2 upper retainers & 2 lower retainers	\$69.95
10-516-K	67-72 Radiator Retainer Kit - heavy duty, 4 row rad - 4 pads, 2 upper retainers & 2 lower retainers	\$69.95
10-515-UR	67-72 Radiator Pad Retainer - upper, 2 & 3 row rad, each - light duty	\$19.95
10-515-LR	67-72 Radiator Pad Retainer - lower, 2 & 3 row rad, each - light duty	\$19.95
10-515-PK	67-72 Radiator Pads - upper or lower, 3 row rad, set of 4 - light duty	\$15.95
10-515-P	67-72 Radiator Pads - upper or lower, 3 row rad, each - light duty	\$4.50
10-516-UR	67-72 Radiator Pad Retainer - upper, 4 row rad, each - heavy duty	\$21.95
10-516-LR	67-72 Radiator Pad Retainer - lower, 4 row rad, each - heavy duty	\$19.95
10-516-P	67-72 Radiator Pads - upper or lower, 4 row rad, pair - heavy duty	\$11.95



Part No.		Price
RAD HOSES		
18-5556	67-67 Upper Rad Hose - 327, molded hose	\$34.95
10-5751	67-72 Upper Rad Hose - 6 cyl	\$39.95
18-5120	68-72 Upper Rad Hose - 327/350, w/ or w/o A/C, molded	\$44.95
18-5120-GM	68-72 Upper Rad Hose - 327/350, w/ or w/o A/C, molded - w/ GM #3947120 stamp	\$44.95
18-5441	69-72 Upper Rad Hose - 396/402, molded	\$39.95
18-5541-GM	69-72 Upper Rad Hose - 396/402, molded - w/ GM #3898541 stamp	\$44.95
18-5517	68-72 Upper Rad Hose - 327/350, on all 4x4 trucks - one-piece molded, replaces the OE 3pc with steel pipe	\$54.95
18-5517-GM	68-72 Upper Rad Hose - 327/350, on all 4x4 trucks, US made - one-piece molded, replaces the OE 3pc with steel pipe, w/ GM #3947117 stamp	\$59.95
18-5487	67-72 Lower Rad Hose - 327/350, GM #3918487 - also fits 69-72 4x4 Blazer, molded hose	\$52.95
18-5488	68-72 Lower Rad Hose - 327/350, w/ A/C, GM #3918488 - also fits 2WD Blazer, molded hose	\$44.95
18-5117	69-72 Lower Rad Hose - 396/402, molded, GM #3947117	\$42.95
10-5489	67-72 Lower Rad Hose - 6cyl	\$39.95
18-0216	Rad Hose Clamp - 2 1/16", tower style, each	\$5.95
18-0256	Rad Hose Clamp - 2 5/16", tower style, each	\$5.95
RAD CAP		
41-ORC-7B	55-62 Rad Cap - 7lb, replacement	\$12.95
41-ORC-16	47-87 Rad Cap - 16lbs	\$13.95
RADIATOR OVERFLOW		
44-0255-15	Universal - 15" polished stainless steel	\$84.95
18-0MCR-3	Coolant Return Container Kit - w/ mounting hwd, 1 1/2 quart	\$69.95
10-00FH	60-72 Overflow Drain Hose - 6 & 8cyl, 3ft - correct thin walled 3/8 hose from rad neck to lower rad	\$9.95
18-0361	67-74 Overflow Hose Retainer - at battery tray	\$6.95
41-0254	40-87 Radiator petcock - brass	\$8.95
FAN CLUTCH		
18-0198	67-87 Cooling Fan Clutch - w/ V8	\$82.95



Part No.		Price
HEATER HOSE		
18-0401	Heater Hose - 5/8" black, per foot, (approx. 3 1/3" ft required)	\$3.00
18-0402	Heater Hose - 3/4" black, per foot, (approx. 3 1/3" ft required)	\$3.00
18-0316	Heater Hose Clamp - 1 3/16" tower style, each	\$4.95
18-0116	Heater Hose Clamp - 1 1/16" tower style, each	\$4.95
18-0055	Heater Hose Support Clamp - on inner fender	\$16.95
22-0205-1	Heater & A/C Hose Retainer - each	\$16.95
18-00HA-1	Hose Adaptors - adjusts from 1 3/4" to 2"	\$11.95
18-00HA-2	Hose Adaptors - adjusts from 1 1/2" to 1 3/4"	\$11.95
THERMOSTAT		
18-0160	Thermostat -160 degree	\$14.95
18-0180	Thermostat -180 degree	\$14.95
18-0195	Thermostat -195 degree	\$14.95
18-0425	67-76 Thermostat Housing - V8, aluminum, w/ gasket, 3/4 outlet	\$26.95
41-0453	58-66 Thermostat housing - V8	\$39.95
41-0454	Thermostat Housing - V8, aluminum, w/ gasket, angle	\$24.95
38-0224	63-84 Thermostat Base to Head Gasket - 6cyl, 230/250	\$3.95
41-0930	Thermostat Housing Gasket - all 6 & 8cyl	\$3.95
WATER PUMP & INTAKE FITTINGS		
41-0058	5/8 hose fitting - 1 1/2" long	\$11.95
41-0034	3/4 hose fitting - 1 3/4" long	\$11.95
41-0034-L	3/4 hose fitting - 2 3/4" long	\$11.95
WATER PUMP		
41-0235	55-74 Water Pump - chevy , 6cyl, w/o pulley	\$169.95
41-0898	55-72 Water Pump - SB, short style	\$109.95
41-0109	69-76 Water Pump - small block	\$99.95
WATER PUMP BYPASS HOSE		
18-0424	66-68 Bypass Hose - 327	\$19.95
10-0424	65-74 Bypass Hose - 292, 6cyl	\$21.95
10-5378	68-72 Bypass Hose - big block w/ short neck water pump	\$14.95
WATER CONTROL VALVE		
22-0299	47-87 Manual Water Control Valve - pull to open, 5/8" hose - can use choke-throttle cable to operate	\$42.95



Part No.		Price
CHEVY PARK LIGHTS		
19-501-HL	67-68 Park Light Assembly - w/ amber lens, complete, left	\$99.95
19-501-HR	67-68 Park Light Assembly - w/ amber lens, complete, right	\$99.95
19-501-AL	67-68 Park Light Lens - amber, left	\$10.95
19-501-AR	67-68 Park Light Lens - amber, right	\$10.95
19-501-CL	67-68 Park Light Lens - clear, left	\$9.95
19-501-CR	67-68 Park Light Lens - clear, right	\$9.95
19-501-ALED	67-68 LED Park Lamp Lens - amber, left & right, each	\$69.95
19-501-G	67-68 Park Light Lens Gaskets - pair	\$7.95
19-501-L-KIT	67-68 Park Lens Screw Kit - OE style, w/ collar, 4pcs	\$8.95
19-502-HL	69-70 Park Light Assembly - w/ clear lens, left	\$94.95
19-502-HR	69-70 Park Light Assembly - w/ clear lens, right	\$94.95
19-502-AL	69-70 Park Light Lens - amber, left	\$12.95
19-502-AR	69-70 Park Light Lens - amber, right	\$12.95
19-502-CL	69-70 Park Light Lens - clear, left	\$9.95
19-502-CR	69-70 Park Light Lens - clear, right	\$9.95
19-502-ALED-L	69-70 LED Park Lamp Lens - amber, left	\$78.95
19-502-ALED-R	69-70 LED Park Lamp Lens - amber, right	\$78.95
19-502-CLED-L	69-70 LED Park Lamp Lens - clear, left	\$78.95
19-502-CLED-R	69-70 LED Park Lamp Lens - clear, right	\$78.95
19-502-G	69-70 Park Light Lens Gaskets - pair	\$6.95
19-502-L-KIT	69-72 Park Light Lens Screw - OE style, w/ collar, each	\$8.7
19-502-HSK	69-70 Park Housing to Grille Screw Kit - 16pcs, both sides	\$4.50



19-501-HL



19-501-AL



19-501-CL



19-501-ALED



19-501-G



19-501-L-KIT



19-502-HL

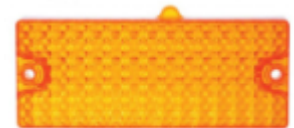

19-502-AR



19-502-CR

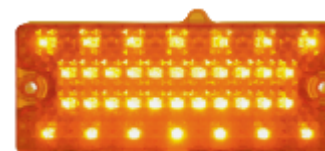

19-502-ALED-L

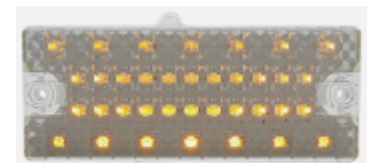

19-502-ALED-C



19-502-G



19-502-L-KIT



19-502-HSK

Part No.		Price
CHEVY PARK LIGHTS		
19-503-L	71-72 Park Light Assembly - w/ amber lens, left	\$95.95
19-503-R	71-72 Park Light Assembly - w/ amber lens, right	\$95.95
19-503-AL	71-72 Park Light Lens - amber, left	\$12.95
19-503-AR	71-72 Park Light Lens - amber, right	\$12.95
19-503-CL	71-72 Park Light Lens - clear, left	\$13.95
19-503-CR	71-72 Park Light Lens - clear, right	\$13.95
19-503-ALED	71-72 LED Park Lamp Lens - amber, fits left & right, each	\$83.95
19-503-G	71-72 Park Light Lens Gaskets - pair	\$14.95
19-503-L-KIT	71-72 Park Lens Screw Kit - OE style w/ collar, 8 pcs	\$13.95
19-503-BC	71-72 Park Light Housing Bumpers - pair	\$3.00
GMC PARK LIGHTS		
19-505-A	67-72 Park Light Lens - amber, w/ rivets, left or right, each	\$29.95
19-505-HL	67-72 Park Light Housing - left	Inquire
19-505-HR	67-72 Park Light Housing -right	Inquire
19-505-HS	67-72 Park Light Housing Screw Kit - 4pcs	\$2.50
19-505-S	67-72 Park Light Housing Support - w/ hdw, each	\$8.95
19-0510	Front Park Light Socket - w/ harness, 2 wire self grounding	\$9.95
LIGHT BULBS		
(S) = single contact (D) = double contact, note the lock pin if its matching or off set. (CP) = candle power		
19-0179A	12V, amber, 3 CP, (D) w/ off set pin, signals, each	\$2.25
19-0057	12V, (D) w/ off set pins, signals, brakes, each	\$1.25
18-0DB-12V	12V, (S) w/ matching pins, heater control, each	\$1.75
19-0194	72-87 Push In Bulb - clear, dash, side lights, each	\$0.95
19-0194-A	72-87 Push In Bulb - amber, side markers, each	\$1.65
5-0211	60-72 Dome Lamp Bulb - each	\$3.25
Please check for bulb clearance when installing LED lights - 27 High Power 5050 LED chips		
19-0057-LED-R	LED Bulb - replace 1157 in RED signal, brake	\$14.95



Part No.		Price
SIDE MARKER LIGHT		
All lights include hardware & gaskets, except LED side lights. Use # 19-508-GD		
19-508-AS	68-72 Standard Side Light - amber, front, each	\$16.95
19-508-RS	68-72 Standard Side Light - red, rear, each	\$16.95
19-508-GS	68-72 Standard Side Light Gaskets - set of 4	\$15.95
19-0418	68-87 Side Marker Light Socket - w/o bulb	\$5.95
19-508-AD	68-72 Deluxe Side Lights - amber, front, each	\$23.95
19-508-RD	68-72 Deluxe Side Lights - red, rear, each	\$23.95
19-508-CD	68-72 Deluxe Side Lights - clear, front or rear, each	\$19.95
19-508-GD	68-72 Deluxe Side Light Gaskets - set of 4	\$15.95
19-508-AD-LED	68-72 LED Deluxe Side Lights - amber, front, each	\$65.95
19-508-RD-LED	68-72 LED Deluxe Side Lights - red, rear, each	\$65.95
19-508-T	68-72 Deluxe Side Light Trim - each	\$4.25
19-508-SK	68-72 Side Light Screw Kit - 16pcs, both sides	\$8.95
FLEETSIDE BRAKE & REVERSE LIGHT		
19-506-LED	67-72 LED Brake Light Assembly - red, each <i>- fully sealed solid state circuit boards, plugs into original taillight socket</i>	\$65.95
19-506-R	67-72 Brake Light Lens - red, each	\$11.95
19-506-C	67-72 Brake Light Lens - clear, each	\$8.95
19-506-G-B	67-72 Brake Light Lens Gaskets - pair	\$4.50
19-506-G	67-72 Brake Light Lens Gaskets - OE style, w/ vent filter, pair	\$7.95
19-506-H	67-72 Brake Light Lens Housing - each	\$36.95
19-507-HL	67-72 Reverse Light Assembly - w/ harness, left	\$39.95
19-507-HR	67-72 Reverse Light Assembly - w/ harness, right	\$39.95
19-507-L	67-72 Reverse Light Lens - left	\$11.95
19-507-R	67-72 Reverse Light Lens - right	\$11.95
19-507-G	67-72 Reverse Light Lens Gaskets - w/ drain filter, pair	\$4.95
19-5067-HK	67-72 Brake & Reverse Housing Hardware Kit - 8 pcs	\$3.45
19-0LS	67-72 Brake, Reverse Roof Lens Screw Kit - 1 1/4" long, 4 pcs	\$2.95



19-508-AS



19-508-RS



19-508-GS



19-508-AD



19-508-RD



19-508-CD



19-508-GD



19-508-T



19-508-SK



19-0418



19-506-R



19-506-C



19-506-LED



19-506-G



19-5067-HK



19-507-G



19-506-H



19-507-HL



19-507-R



19-0LS

Part No.		Price
STEPSIDE TAILLIGHTS		
19-0510-H	67-76 Taillight Assembly - black, w/ harness, each	\$59.95
19-0510-HS	67-76 Taillight Assembly - stainless steel, w/ harness, each	\$99.95
19-0510-R	67-76 Taillight Lens - red, each	\$11.95
19-0510-G	67-76 Taillight Lens Gaskets - pair	\$5.95
19-0510-SK	67-76 Taillight Lens Screw Kit - 6 pcs	\$2.00
19-0510-BL	67-76 Taillight Bracket - black, left	\$19.95
19-0510-BR	67-76 Taillight Bracket - black, right	\$19.95
19-0510-SL	67-76 Taillight Bracket - stainless steel, left	\$26.95
19-0510-SR	67-76 Taillight Bracket - stainless steel, right	\$26.95
19-0511-H	64-76 Reverse Light Assembly - left or right, each	\$59.95
19-0511-L	64-76 Reverse Light Lens - clear, left or right, each	\$7.95
19-0511-G	64-76 Reverse Light Lens Gaskets - pair	\$2.50
19-0511-BL	67-76 Reverse Light Bracket - black, left	\$19.95
19-0511-BR	67-76 Reverse Light Bracket - black, right	\$19.95
17-0510-KA	54-72 Light Bracket Bolt Kit - reverse & brake, 12 pc kit - stainless, phillips drive, w/ washers & nuts	\$7.95
17-0510-KB	54-72 Light Bracket Bolt Kit - reverse & brake, 12 pc kit - stainless, 7/16" hex head, w/ washers & nuts	\$7.95
17-0208	Wire Conduit - stainless steel, pair	\$19.95
17-0208-G	47-72 Taillight Harness Grommets - pair	\$2.75
SUBURBAN / PANEL TAILLIGHTS		
19-515	67-72 Brake Light Lens - red, left & right, each	\$29.95
19-506-G	67-72 Brake Light Lens Gaskets - pair	\$7.95
19-516	67-72 Reverse Light Lens - clear, each	\$15.95
19-516-G	67-72 Reverse Light Lens Gaskets - pair	\$9.95
BLUEDOTS		
17-0209-P	Plastic Blue Dots - pair - round lights that sit on raised pods on roof	\$11.95



Part No.		Price
ROOF LIGHTS		
19-0518	67-87 Roof Light Lens - amber, each	\$19.95
19-0518-G	67-87 Roof Light Lens Pad - each	\$8.95
17-0033-K	55-87 Roof Light Kit - with harness, bulbs & switch 5 lights	\$214.95
19-0410	Replacement Socket - w/ 194 bulb, and stub harness, each <i>- secures to rubber pad, must be spliced into OE harness</i>	\$4.90
HEADLIGHT HOUSINGS		
19-0422	62-68 Headlight Housing - Chev , left or right, each <i>- also fits 69-72 Chev left</i>	\$44.95
19-522-R	69-72 Headlight Housing - Chev , right, each	\$42.95
<i>Location info is stamped on the ear of housing, 3 tabs each pot</i>		
19-507-1	67-72 Headlight Housing - GMC , outer, w/ trim ring, & hdw, left	\$39.95
19-507-2	67-72 Headlight Housing - GMC , inner, w/ trim ring, & hdw, left	\$39.95
19-507-3	67-72 Headlight Housing - GMC , outer, w/ trim ring, & hdw, right	\$39.95
19-507-4	67-72 Headlight Housing - GMC , inner, w/ trim ring, & hdw, right	\$39.95
19-507-K	67-72 Headlight Housing Kit - GMC , w/ trim rings & hdw, 4 pots <i>- location info is stamped on ear, 3 tab on each pot</i>	\$154.95
HEADLIGHT BULB RETAINER		
12-0HR-1	65-72 Headlight Retainer - CHEV , stainless steel, each <i>- with single headlight, 2 retainer tabs</i>	\$18.95
19-0HR-3	65-72 Headlight Retainer - GMC , stainless steel, each <i>- with 4 headlights, 3 screw tabs</i>	\$12.95
12-0HRS-6	47-87 Headlight Retainer Screw Set - 6 pcs	\$2.95
HEADLIGHT ADJUSTERS & SPRINGS		
19-0525	62-68 Headlight Adjuster Screw & Nut - each	\$2.45
19-525-G	69-72 CHEV 67-72 GMC Headlight Adjuster Screw & Nut - each	\$1.95
19-0528-S	62-68 CHEV & 67-72 GMC Headlight Adjust Spring	\$3.95
19-529-S	69-72 Headlight Adjuster Spring - CHEV , each	\$4.95
HEADLIGHT SEAL BEAM		
16-0206-12	55-87 Headlights - halogen, high/low, each	\$23.95
16-05001H	58-72 Headlights - GMC , high/low, (inner), each	\$22.95
16-05006H	58-72 Headlights - GMC , high, (outer), each	\$21.95
16-0001	Headlight Socket - w/ stub harness, 3 wire	\$3.95



Part No. **Price**

CUSTOM WIRING HARNESS - American Autowire Kit

New updated wiring harness w/ 18 fuse - 21 circuit. Includes plugs, switches for original or aftermarket gauges. HEI or point type dist harness. Column connectors for stock or updated columns. Front, rear & dome light harness. Updates for original or AC, power windows, seats, stereo, electric fuel pumps etc

- 19-5333 67-68 Complete Harness Kit - CHEV & GMC \$1249.95
- 19-5089 69-72 Complete Harness Kit - CHEV only \$1249.95
- GMC requires using original front light harness

HARNESS GUTTERS

- 10-517-R 67-72 Harness Gutter - at rad support, w/ hdw \$16.95
- 10-517-F 67-72 Harness Gutter - at firewall, w/ hdw \$16.95

ENGINE HARNESS

includes firewall harness gutter

- 19-5980 67-67 6 Cyl Manual Trans \$229.95
- 19-5245-H 67-67 V-8 Manual Trans, w/ HEI ignition \$235.95
- 19-5425-H 67-67 V-8 Auto Trans, w/ HEI ignition \$229.95
- 19-5435 67-72 6 Cyl Auto Trans \$229.95

- 19-5420H 68-69 V-8 Auto Trans, w/ HEI ignition \$229.95
- 19-5655 68-69 6 Cyl & 396, w/ Auto Trans \$229.95
- 19-5430 68-69 6 Cyl w/ standard transmission \$229.95
- 19-5985-H 68-69 V-8 Manual Trans, w/ HEI ignition \$229.95
- 19-5985 68-69 V-8 Manual Trans \$229.95
- 19-5655-H 68-69 396 Auto Trans, w/ HEI ignition \$229.95
- 19-5420 68-69 V-8 Auto Trans \$229.95

- 19-5850 70-72 6 Cyl Manual Trans \$229.95
- 19-5230 70-72 396 Auto Trans, w/ points \$229.95
- 19-5230-H 70-72 396 Auto Trans, modified for HEI ignition \$229.95
- 19-5520 70-72 V-8, w/ Auto Trans \$229.95
- 19-5520-H 70-72 V-8, w/ Auto Trans modified for HEI ignition \$229.95
- 19-5795 70-72 V-8, w/ Manual Trans \$229.95
- 19-5795-H 70-72 V-8, w/ manual trans, w/ HEI ignition \$229.95

- 19-0001 Harness - HEI distributor, battery & tach, w/ 8" extension, pair \$14.95

TORQUE CONVERTER LOCKUP KIT

- 19-0412 Torque Converter Lockup Kit - GM 200-4R, 700R4 \$129.95
- includes pressure switch, in line fuse

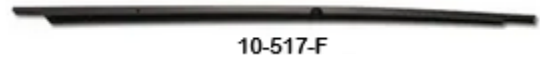
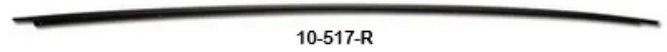

Part No.		Price
TRANSMISSION CONTROL SPARK HARNESS		
19-5880	70-70 6 Cyl w/ Auto	Inquire
19-5885	70-70 6 Cyl w/ Manual	Inquire
19-5870	70-70 V8, w/ Auto	Inquire
19-5860	70-70 V8, w/ Manual	Inquire
20875	70-70 V8, 396 or 400, w/ manual	Inquire
20865	70-70 V8, w/ TH 400, Auto	Inquire
22040	71-71 6 Cyl, w/ Auto	Inquire
22020	71-71 6 Cyl, w/ Manual	Inquire
22045	71-71 V8, w/ Auto	Inquire
22050	71-71 V8, w/ Manual	Inquire
22055	71-71 V8, w/ TH 400	Inquire
23475	72-72 w/ Auto	Inquire
22025	72-72 w/ Manual	Inquire
19-5035	72-72 V8, 396 or 400, w/ Auto	\$124.95



TRANSMISSION KICKDOWN HARNESS		
19-5900	67-68 TH 400 Trans, carb mounted kickdown switch	\$69.95
19-5895	69-69 TH 400 Trans, carb mounted kickdown switch	\$49.95
19-5865	70-70 TH 400 Trans, TCS, carb mounted kickdown switch	\$89.95
19-5890	70-70 TH 400 Trans, w/o TCS, w/ carb mounted kickdown switch	\$49.95
19-5855	71-72 TH 400 Trans, w/ gas pedal mounted kick down - firewall to transmission harness	\$33.95
19-5039	71-72 TH 400 Trans, w/ gas pedal mounted kick down - fuse panel to switch to firewall	\$84.95



DASH HARNESS		
New fuse panel harness requires, 2 x 3A, 2 x 10A, 2 x 15A, 2 x 20A fuses.		
19-5915	67-68 Dash Harness - w/ gauges, pickup	\$699.95
19-5920	67-68 Dash Harness - w/ lights, pickup	\$699.95
33905	67-68 Dash Harness - w/ gauges, suburban & panel	Inquire
33910	67-68 Dash Harness - w/ lights, suburban & panel	Inquire
19-5090	69-69 Dash Harness - w/ gauges, suburban & panel	\$699.95
19-5095-L	69-69 Dash Harness - w/ lights, suburban & panel	\$699.95
19-5100	69-72 Dash Harness - w/ gauges, pickup & blazer	\$699.95
19-5105	69-72 Dash Harness - w/ lights, pickup & blazer	\$699.95



Part No.		Price
CHEV FRONT LIGHT HARNESS		
Note - 83-85 design, alt w/ internal regulator. Includes harness gutters at rad support.		
19-5440	67-67 Front Light Harness - w/ gauges & side lights	\$299.95
19-5250	67-67 Front Light Harness - w/ gauges, w/o side lights	\$325.00
19-5250-DI	67-67 Front Light Harness - w/ gauges, w/ internal voltage alt - (83-85) drivers side mount alternator, without marker lights	\$349.95
19-5440-PI	67-67 Front Light Harness - w/ gauges, w/ internal voltage alt - (83-85) passenger side mount alternator, without marker lights	\$349.95
19-5500	68-68 Front Light Harness - w/ gauges, w/o working side lights	\$299.95
19-5490	68-68 Front Light Harness - w/ lights, w/o working side lights	\$269.95
19-5500-DI	68-68 Front Light Harness - w/ gauges, w/ internal voltage alt - (83-85) drivers side mount alternator, without marker lights	\$299.95
19-5500-PI	68-68 Front Light Harness - w/ gauges, w/ internal voltage alt - (83-85) passenger side mount alternator, without marker lights	\$289.95
19-5490-PI	68-68 Front Light Harness - w/ lights - with internal alt-passenger side, w/o working side lights	\$349.95
<i>For working side lights on 68 use the 69 & up listings</i>		
19-5220	69-72 Front Light harness - w/ gauges	\$299.95
19-5445	69-72 Front Light Harness - w/ lights	\$299.95
19-5445-DI	69-72 Front Light Harness - w/ lights, w/ left side internal alt	\$329.95
19-5445-PI	69-72 Front Light Harness - w/ lights, w/ right side internal alt	\$329.95
19-5220-PI	69-72 Front Light Harness - w/ gauges w/ internal voltage alt - (83-85) passenger side mount alternator	\$399.95
19-5220-DI	69-72 Front Light Harness - w/ gauges w/ internal voltage alt - (83-85) drivers side mount alternator	\$389.95
GMC FRONT LIGHT HARNESS		
Note 69-72 GMC light harness will also work on 67-68 without lights		
19-5530	69-72 Front Light Harness - w/ gauges, - can also use on 67-68 without lights	\$359.95
19-5530-PI	69-72 Front Light Harness - w/ gauges, w/ internal voltage alt - w/ internal alt-passenger side, will fit 67-68 without lights	\$359.95
19-5530-DI	69-72 Front Light Harness - w/ gauges, w/ internal voltage alt - w/ internal alt-drivers side, can also use on 67-68 without lights	\$359.95
19-5535-DI	69-72 Front Light Harness - w/ gauges, 4WD - w/ internal alt-drivers side, w/ working side lights	\$499.95
19-5535-PI	69-72 Front Light Harness - w/ gauge, 4WD - w/ internal alt-passenger side, w/ working side lights	\$499.95



19-5250



19-5500-DI



BILL'S TRUCK SHOP LTD.

CHEV

Est. 1987

GMC

40-90 PARTS & ACCESSORIES

PICTURE COMING SOON

Part No.		Price
FRONT TO REAR HARNESS		
19-5005	67-72 Front to Rear - 127" & 133" wheelbases	\$124.95
19-5965	67-72 Front to Rear - 102" & 115" wheelbases	\$114.95
19-5235	67-69 Front to Rear - panel & suburban	\$197.95
19-5234	70-72 Front to Rear - panel & suburban	\$199.95
REAR LIGHT HARNESS		
Includes reverse, brake & license light		
19-5855-67	67-68 Fleetside Rear Light Harness - w/o side lights	\$179.95
19-5852	67-68 Stepside Rear Light Harness - w/o side lights	\$179.95
19-5075	68-72 Fleetside & Blazer Rear Light Harness	\$214.95
19-5095	68-72 Stepside Rear Light Harness - w/ side lights	\$219.95
19-5975-PS	69-72 Rear Connector to Rear Lights - 2 required, each - panel & suburban	\$45.95
HARNESS CLIPS		
37-0315	Clamp - Insulated style, w/ hdw, pair	\$3.75
18-0204-F	60-72 Harness Clips – OE Style, w/o coating, set of 4 - longer insert for frame thickness and rear cross sill	\$12.95
FUSES (BARREL STYLE)		
18-0003	- 3 amp, 9/16" long	\$0.99
18-0004	- 4 amp, 1 1/4" long	\$0.99
18-0005	- 5 amp, 1 1/4" long	\$0.99
18-0010	- 10 amp, 1 1/4" long	\$0.99
18-0015	- 15 amp, 1 1/4" long	\$0.99
18-0020	- 20 amp, 1 1/4" long	\$0.99
19-5005-FK	67-72 Fuse Kit - 18-pcs, 6 x 3A, 2 x 10A, 6 x 15A, 4 x 20A - kit supplies 2 fuses for each location	\$15.95
19-5003	Front Harness Fuse at Battery - 3 amp, 3/4" long	\$1.00
18-0987	Fuse holder - sealed, w/ hdw & fuse	\$5.95
10-503	67-72 Fuse Panel Gasket - each	\$2.50
19-0064	Dielectric Grease - use on all fuse panel pins and connectors - prevents corrosion from forming	\$1.50
HOOD LAMP		
15-0HL	Under Hood Lamp Assembly - reproduction GM option	\$69.95



19-5005



19-5975-PS



19-5095



37-0315



18-0204-F

AG 1/4 x 1 1/4" glass fuses



10-0064



19-5005-FK



18-0987



19-5003



10-503



15-0HL

Part No.		Price
HEATER & A/C		
19-5520-67	67-68 Heater Harness - w/o AC	\$46.95
19-5470	69-72 Heater Harness - w/o AC	\$54.95
19-5550	67-72 Heater Motor Ground Wire	\$3.00
19-5825	67-67 AC harness	Inquire
19-5835	68-68 AC harness	Inquire
19-5805	71-72 AC harness - w/ anti-dieseling relay	\$179.95
19-5260	69-72 AC harness - w/o anti-dieseling relay	\$179.95

BATTERY CABLES		
19-0204	Battery Cable - negative, black, 25" long, 4g, w/ clamp end	\$23.95
19-0204-S	Battery Cable - negative, black, 25" long, 4g, w/ side terminal	\$24.95
19-0207	Battery Cable - positive, red, 43" long, 4g, w/ clamp end	\$34.95
19-0207-S	Battery Cable - positive, red, 43" long, 4g, w/ side terminal	\$32.95

OE Style side terminal cable ends are heavy duty .062 brass ring terminals, crimped & soldered to a 4 gauge cable. **NOTE** some side post batteries have recessed threads and may require a longer bolt. Cables are year specific but will fit other years.

19-5972-SBN	72-72 Battery Cable (OE Style) - negative, 2 & 4WD, SB - w/ aux body ground wire, approx., 26" long	\$99.00
19-5972-SBP	72-72 Battery Cable (OE Style) - positive, 2 & 4WD, SB - w/ aux body ground wire, approx., 44" long	\$99.00

8-0880	Battery Cable End - replacement clamp style	\$3.95
8-0878	Cable Adaptors - side post cable to top post battery, pair	\$9.95
8-0760-R	Battery Cable Top Post Cover - positive, red	\$2.95
8-0760-B	Battery Cable Top Post Cover - negative, black	\$2.95

19-5215	67-72 Battery Junction Block - at right front fender	\$13.95
---------	--	---------

GROUND STRAP KIT

19-0655-K	67-72 Ground Strap Kit - w/ hdw - 1 right fender, 1 right front cab support., 2 engine, 1 bed rear	\$39.95
18-0170-8	Ground Strap - tin coated, 8" #11g w/ 3/8 eyelets - excellent for grounding body to frame, example cab to bed	\$12.95

COURTESY LIGHTS & RADIO

19-5685	67-72 Courtesy Lights - w/ harness	\$69.95
19-5680	67-72 Courtesy Light Harness - fuse panel to door jam switches	\$34.95
19-05171	67-72 Courtesy Light Bulb - single contact. w/ matching pins	\$2.50
19-0504	67-72 Door Jam Switch - w/ round insert, each	\$19.95



19-5520-67



19-5260



19-0204



19-0204-S



8-0880



8-0760-B



8-0760-R



19-5972-SBP



8-0878



19-5215



19-0655-K



18-0170-8



19-5685



19-0504



19-05171

19-5680

Part No.		Price
HORN		
14-042-H	47-87 Horn - high tone, 12V, universal	\$21.95
14-042-L	47-87 Horn - low tone, 12V - universal	\$21.95
14-0452-LOE	63-87 Horn - low tone, OE style, w/ brackets	\$99.95
14-0452-HOE	63-87 Horn - high tone, OE style, w/ brackets	\$99.95
WIRING RETAINERS		
18-0853	Harness Support - nylon, fits 1/4 hole, 2 1/2" long, each	\$5.75
18-0514	Harness Support - nylon, fits 1/4 hole, 1 1/2" long, each	\$3.25
18-0391	Harness Support - nylon, snaps into 2 holes, each	\$3.95
WIRE LOOM		
18-0WL-1	Wire Loom - 1/4 fabric, per foot	\$1.50
18-0WL-3	Wire Loom - 3/8 fabric, per foot	\$1.50
18-0WL-5	Wire Loom - 1/2 fabric, per foot	\$1.95
19-0316	Wire Insulator - OE Style, black asphalt coated fabric 3/16ID, ft	\$2.50
FUEL TANK GAUGE WIRE		
19-5570	67-72 Fuel Tank Harness - pickup, w/ push on end	\$22.95
19-5249	67-72 Fuel Tank Harness - panel & suburban	\$18.95
19-0352	Retaining clip - secures fuel tank wire to tank at top seam, pair <i>- also secures courtesy lamp wire to dash</i>	\$2.00
OIL PRESSURE SENDER		
19-0020	60-87 Oil Pressure Sender - w/ lights	\$19.95
WATER TEMP SENDER		
19-0469	55-72 Water Temp Sender - w/ gauges, 6 or 8cyl, 1/2 x 1/4 NPT <i>- with center "T" pin</i>	\$39.95
19-0469-A	57-78 Water Temp Sender - w/ gauges, 6 or 8cyl, 1/2 x 1/4 NPT <i>- with "T" terminal, correct resistance for a more accurate</i>	\$45.95
19-0629	69-74 Water Temp Sender - w/ lights, electrical, w/ 2 spades	\$39.95
19-0607	69-72 Water Temp Sensor - w/ dash light, single spade	\$38.95
VOLTAGE REGULATOR		
19-0VR	63-72 Voltage Regulator - 12 volt, neg ground <i>- mechanical 2 unit type</i>	\$99.95
19-0VR-MK	63-72 Voltage Regulator Mount Kit - w/ cushion nuts, OE style	\$12.95



Part No. **Price**

**** PLEASE READ THE FOLLOWING ****

Most panels are 18-gauge, E-D-Primer coated and are carefully packaged to protect against damage that may occur during transit. However, after overseas transport & cross-country delivery to you, it is likely there could be a small ding or minor scratch. These minor blemishes cannot be helped and are considered normal due to the nature of the product. Any physical damage in transit must be reported to delivering carrier at time of delivery. Test fit all panels prior to paint and installation.

GRILLE SURROUND

2-505-GS 67-68 Grille Surround - CHEV **\$649.95**

RAD SUPPORT

20-501-67C 67-68 Rad Support - CHEV **\$399.95**

20-501-69C 69-72 Rad Support - CHEV **\$399.95**

20-501-67G 67-68 Rad Support - GMC **\$489.95**

20-501-G 67-72 Rad Support - GMC **\$489.95**

27-5160 67-72 Rad Support Repair Panel - lower right 16" L x 3" W
- replaces rusted out area below battery tray at inner fender **\$59.95**

1-5301 67-68 Gravel Shield - below rad support **\$89.95**

1-5301-HK 67-68 Gravel Shield Bolt Kit - 12pcs **\$16.95**

RAD SUPPORT TO GRILLE FILLER PANELS

These panels close the gap between the rad support & grille for a nicer appearance and also direct air to rad for better cooling. Made of high-grade aircraft aluminum that is anodized or polished – resistant to water spotting & fingerprints

20-504-67-B 67-68 Filler Panels - black, w/ instructions & hdw, pair **\$224.95**

20-504-67-S 67-68 Filler Panels - silver, w/ instructions & hdw, pair **\$224.95**

20-504-69-B 69-72 Filler Panels - black, w/ instructions & hdw, pair **\$224.95**

20-504-69-S 69-72 Filler Panels - silver, w/ instructions & hdw, pair **\$224.95**



2-505-GS



20-501-67C



27-5160



20-501-69C



20-501-67G



20-501-69G



1-5301



20-504-69-B



20-504-69-S

Part No.		Price
FRONT FENDERS		
20-505-67L	67-67 Front Fender - Chev & GMC, left	\$424.95
20-505-67R	67-67 Front Fender - Chev & GMC, right	\$424.95
20-505-68L	68-68 Front Fender - Chev & GMC, left	\$409.95
20-505-68R	68-68 Front Fender - Chev & GMC, right	\$409.95
20-505-69CL	69-72 Front Fender - Chev, left	\$399.95
20-505-69CR	69-72 Front Fender - Chev, right	\$399.95
20-505-68L	69-72 Front Fender - GMC, left	\$409.95
20-505-68R	69-72 Front Fender - GMC, right	\$409.95
20-505-FS	67-72 Front Fender Support - at lower "A" post, pair	\$22.95
20-506-S	67-72 Fender to Rad Support - corner, fits left & right, each	\$16.95
INNER FENDERS		
20-510-L	67-72 Inner Fender - 19 gauge, left	\$179.95
20-510-R	67-72 Inner Fender - 19 gauge, right	\$179.95
20-510-RB	67-72 Inner Fender Brace - reinforcement, left side	\$8.95
20-510-CB	67-72 Inner Fender to Cab Brace Bolt - each - with correct convex floating washer	\$9.95
20-510-S	67-72 Inner Fender to Cab Shim - 3/16" thick, pair	\$12.95
20-510-K	67-72 Inner Fender to Outer Bolt Kit - 18 pcs, per fender	\$29.95
FRONT END BOLT KIT		
20-512-F	67-72 Front Sheet Metal Bolt Kit - hood, inner & outer fenders, rad support, add 2, #20-510-CB	\$99.95



Part No.		Price
HOODS		
20-50H-67	67-68 Stock Hood	\$899.95
20-50H-69	69-72 Stock Hood	\$899.95
<i>Cowl hoods are all steel with an approx. 2" rise with a screened intake at rear and support brace side to side in middle for a strong design and excellent fit.</i>		
20-5CH-67	67-68 Cowl Hood	\$999.95
20-5CH-69	69-72 Cowl Hood - no emblem holes	\$999.95
HOOD HINGES		
20-515-L	67-72 Hood Hinge - w/o spring, left	\$99.95
20-515-R	67-72 Hood Hinge - w/o spring, right	\$99.95
20-515-BK	67-72 Hood Hinge Bolt Kit - 5pcs, per hinge	\$14.95
20-515-SP	67-72 Hood Hinge Springs - pair	\$49.95
20-515-B	67-72 Hood Hinges - billet, aluminum, w/ hdw, pair <i>- can be ordered with light or heavy duty struts for cowl hoods</i>	\$695.00
COWL SCREEN		
20-516	67-72 Cowl Screen - w/ antenna hole <i>- between hood and windshield</i>	\$379.95
<i>67-72 Cowl screen inserts install under cowl screen to keep out leaves & debris. Comes with hardware, 2 pcs.</i>		
20-517-SS	67-72 Cowl Trash Screen - stainless steel, pair	\$129.95
20-517-B	67-72 Cowl Trash Screen - black, pair	\$89.95



Part No.		Price
BATTERY TRAY		
20-525-B	67-72 Battery Box Bottom	\$25.95
20-525-T	67-72 Battery Box Assembly	\$89.95
20-525-T-S	67-72 Battery Box Assembly - w/o A/C line support bracket - stainless steel	\$149.95
20-525-TAC	67-72 Battery Box Assembly - w/ A/C line support bracket	\$89.95
20-525-TAC-S	67-72 Battery Box Assembly - w/ A/C line support bracket - stainless steel	\$149.95
20-525-AT	67-72 Auxiliary Battery Box Assembly - left side	\$149.95
20-525-ACC	67-72 AC Line Support Clamp - stainless steel, w/ bolt	\$19.95
20-0525-R	67-76 Battery Retainer - w/ bolt	\$8.95
20-0525-R-S	67-76 Battery Retainer - w/ bolt, stainless steel	\$8.95
21-0621	67-76 Battery retainer Bolt	\$1.75
20-525-HK	67-72 Battery Box Bolt Kit - 6pcs	\$8.95
DOORS (PICK UP)		
20-530-L	67-71 Door - complete shell, left	\$699.95
20-530-R	67-71 Door - complete shell, right	\$699.95
20-530-72L	72-72 Door - complete shell, w/ vent screw hole, left	\$699.95
20-530-72R	72-72 Door - complete shell, w /vent screw hole, right	\$699.95
BLAZER & JIMMY		
20-530-LB	69-71 Door - complete shell, blazer & jimmy, left	\$799.95
20-530-RB	69-71 Door - complete shell, blazer & jimmy, right	\$799.95
20-530-72LB	72-72 Door - complete shell, blazer & jimmy, left	\$799.95
20-530-72RB	72-72 Door - complete shell, blazer & jimmy, right	\$799.95
20-530-PB	69-72 Reinforcement Plates - door latch, blazer & jimmy, pair	\$69.95
SUBURBAN & PANEL		
20-530-LS	67-71 Door - complete shell, panel & suburban, left	\$699.95
20-530-RS	67-71 Door - complete shell, panel & suburban, right	\$699.95
20-530-72LS	72-72 Door - complete shell, panel & suburban, left	Inquire
20-530-72RS	72-72 Door - complete shell, panel & suburban, right	Inquire



Part No. **Price**
 Fleetside bedsides are EDP coated. GM restoration parts. 67-68 bedsides had a narrow rear stake pocket to gate design. All new bedsides have the 69-72 rear gate opening design.

SHORT FLEETSIDE BEDSIDES

21-5SFL-67	67-67 Short Fleetside - w/o side light, left	\$999.95
21-5SFR-67	67-67 Short Fleetside - w/o side right, right	\$999.95
21-5SFL-S	67-72 Short Fleetside - left - w/o side light & stake pocket holes	Inquire
21-5SFR-S	67-72 Short Fleetside - right - w/o side light & stake pocket holes	Inquire
21-5SFS-L	68-72 Short Fleetside - left	\$999.95
21-5SFS-R	68-72 Short Fleetside - right	\$999.95

LONG FLEETSIDE BEDSIDES

21-5LFL-67	67-67 Long Fleetside - left	Inquire
21-5LFR-67	67-67 Long Fleetside - right	Inquire
21-5LFL-68	68-72 Long Fleetside - left	\$1195.95
21-5LFR-68	68-72 Long Fleetside - right	\$1195.95

WHEEL TUBS

21-5WT	67-72 Wheel Tub - each	\$149.95
21-5WT-2	67-72 Wheel Tub - 2" wider then stock, each - use with new factory replacement floor designed for 2" tub	\$259.95
21-5WT-16	67-72 Wheel Tub - 16" wide, each - for wider wheel tire combo	\$279.95
21-5WT-K	67-72 Wheel Tub Bolt Kit - both sides, 14pcs	\$19.95

BEDSIDE SUPPORT BRACES

21-5377	67-72 Bedside Support Braces - w/ hdw, pair - at front of rear wheel, also fits Blazer & Jimmy	\$29.95
21-5377-SS	67-72 Bedside Support Braces - w/ hdw, stainless steel, pair - at front of rear wheel, also fits Blazer & Jimmy	\$59.95

BEDSIDE STONE SHIELDS

21-5315-L	67-72 Bedside Stone Shield - at rear of wheel (steel floor), left - requires 2" extension on a Blazer/Jimmy	\$64.95
21-5316-R	67-72 Bedside Stone Shield - at rear of wheel (steel floor), right - requires 2" extension on a Blazer/Jimmy	\$64.95
21-5316-K	67-72 Stone Shield Bolt Kit - to bed, both sides, 10pcs	\$19.95

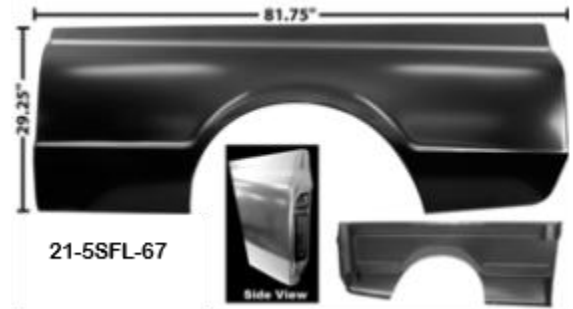

21-5SFL-67



21-5SFS-L



21-5LFL-68



21-5WT



21-5WT-K



21-5WT-16

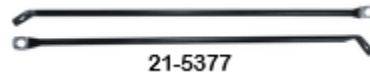

21-5377



21-5316-L

21-5316-R

Part No.		Price
STEEL BED FLOOR		
Complete fleetside bed floor assembly. Original gauge stamped steel, with all under bed cross-sills attached to the floor. Mounting holes are pre-punched. Painted in an EDP black primer		
21-5LBF	67-72 Long Bed Floor	\$1895.00
21-5SBF	67-72 Short Bed Floor	\$1595.00
21-5SBF-2	67-72 Short Bed Floor - w/ 2" wider wheel tub holes - special order	\$1990.00
21-5SBF-16	67-72 Short Bed Floor - w/ 16" wheel tub openings - special order	\$1899.00
STEEL FLOOR CROSS SILLS		
21-5107-A	67-72 Cross Sill - 1 st & 2 nd on long bed, 1 st on short bed	\$72.95
21-5107-B	67-72 Cross Sill - 3 rd on long bed, 2 nd on short bed	\$93.95
21-5107-C	67-72 Reinforcement Strip - at wheel tub, short bed	\$56.95
21-5107-D	67-72 Center Reinforcement Strip - (between wheel tub) - 2 required for short bed, 3 required on long bed	\$56.95
21-5107-E	67-72 Cross Sill - 4 th & 5 th on long bed, 3 rd on short bed - has bed mount holes, secures stone deflectors w/ 13" spacing	\$85.95
21-5107-G	67-72 Rear Bed Cross Sill - secures to stake post w/ steel floor	\$159.95
BED FLOOR REPAIR PANEL		
27-5099	67-72 Bed Floor Repair Panel - 48" x 18 1/2"	\$79.95
27-5098	67-72 Bed Floor Repair Panel - side to side across rear 15" deep	\$199.95
27-5095	67-72 Bed Floor Rear Replacement - 42" deep - 6' bed and blazer rear	\$374.95
27-5097	67-72 Bed Floor Rear Replacement - 50 1/2" long x 72" wide - 8' bed	\$374.95
27-5096	67-72 Bed Floor Front Panel - 53" long, long bed - 8' bed	\$369.95
STEEL FLOOR BED BOLT KITS		
21-5FBK	67-72 Floor to Frame Bolt Kit - w/ steel floor	\$24.95
21-5812	67-72 Floor to Side & Front Bed Panel Bolt Kit - stainless - long & short bed, 50 x 5/16 carriage bolts, nuts, flat & lock washers, 200 pcs	\$84.95
21-5813	67-72 Floor to Side & Front Bed Panel Bolt Kit - plain steel - long & short bed, 50 x 5/16 carriage bolts, nuts, flat & lock washers, 200 pcs	\$39.95

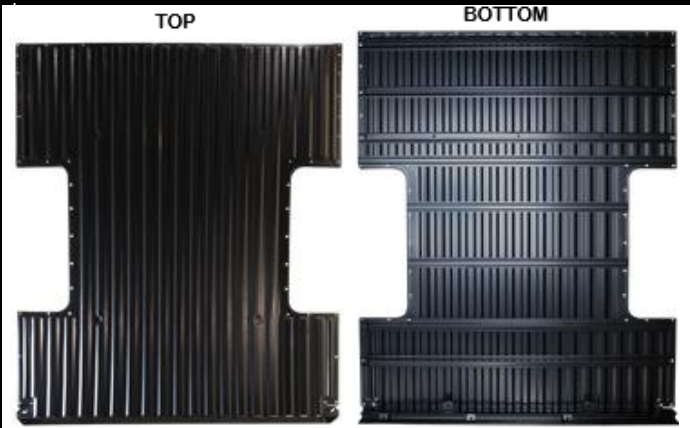

21-5LBF

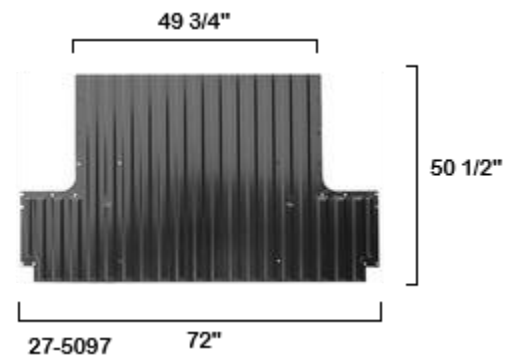
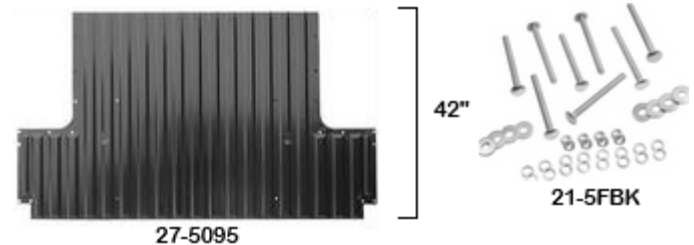
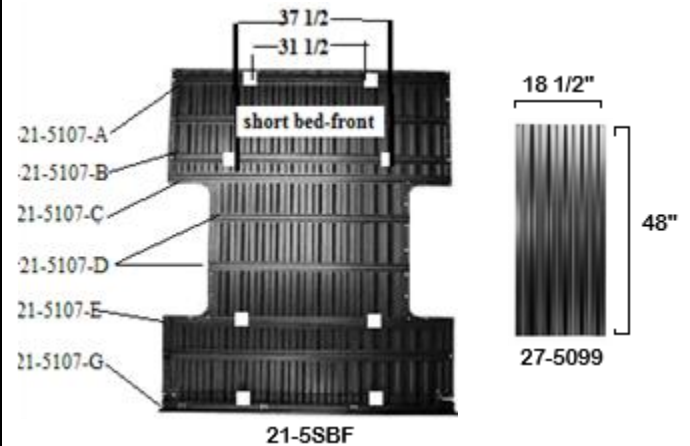

Part No. **Price**

FRONT BED PANEL

Wood floor front bed panels are 3/4" (20") deeper than steel floor front bed panels (19.5").
(measuring from inside roll edge to lower edge)

WOOD FLOOR FRONT BED PANEL

21-5620-T	67-72 Front Bed Panel - w/ wood floor	\$299.95
23-0387-S	54-87 Front Bed Panel Bolt kit - wood floor, steel - cap screws & philips drive screws, stepside & fleetside	\$12.95
23-0387-SS	54-87 Front Bed Panel Bolt Kit - wood floor, stainless, - pan head philips drive screws, stepside & fleetside	\$19.95

STEEL FLOOR FRONT BED PANEL

21-5621-T	67-72 Front Bed Panel - w/ steel floor	\$289.95
21-5716	67-72 Front Bed Panel - w/ embossed BOWTIE, steel floor	\$349.95
21-5621-S	67-72 Front Bed Panel Bolt Kit - steel - includes upper philips drive bolts & panel to floor carriage bolts	\$14.95
21-5621-SS	67-72 Front Bed Panel Bolt Kit - stainless - includes upper philips drive bolts & panel to floor carriage bolts	\$38.95

WOOD FLOOR CROSS SILLS

Cross sills are pre-drilled with plates.

SHORT fleet 3 x cross sills & 1 x reinforcement 72"
LONG fleet 5 x cross sills & 1 x reinforcement 72"
LONGHORN 4 x cross sills & 2 x reinforcement 72" & 1 x 50"

21-0435	63-72 Bed Cross Sill - w/ plates, each	\$69.95
23-0431	60-72 Bed Reinforcement Strip - 1" high x 50" long - between rear wheels	\$44.95
21-0438	60-72 Bed Reinforcement Strip - 1" high x 72' long, galvanized - in front of rear wheel	\$54.95
21-0722-T	63-72 Rear Cross Sill - fleetside	\$269.95
21-0722-HK	63-72 Rear Cross Sill Hardware Kit - stepside & fleetside	\$13.95



21-5620-T



21-0435



21-0722-T

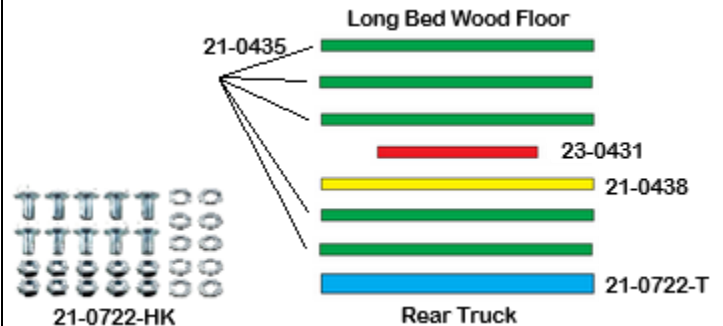

Part No.		Price
TAILGATES		
OE 67-68 tailgates had a thinner design than the 69-72. All new tailgates are OE quality with correct top edge and come in the 69-72 design without hardware.		
21-5FGMC	69-72 Fleetside Tailgate - GMC	\$699.95
21-5FCHEV	69-72 Fleetside Tailgate - CHEV	\$699.95
21-5FBL	67-72 Fleetside Tailgate - BLANK	\$479.95
TAILGATE EDGE GUARD		
21-510-G	67-72 Tailgate Edge Guard - stainless cover, fleetside	Coming
TAILGATE COVER		
21-5766	67-72 Tailgate Cover - smooth	\$189.95
TAILGATE HINGES		
21-510-H	67-72 Tailgate Hinges - pair	\$41.95
21-0510-HK	58-72 Tailgate Hinge Bolt Kit - fleetside, 4pcs	\$14.95
TAILGATE ARMS		
NOTE - when installing NEW tailgate arms, handle must be slightly open for latches to clear arm locks. All new arms are not angled at striker.		
21-510-K	67-72 Tailgate Kit - (1 handle, 2 rods, 2 arms and 2 latches)	\$169.95
21-510-PR	67-72 Tailgate Arms - pair	\$69.95
21-510-AS-K	67-72 Tailgate Arms Kit - stainless, pair - may require holding release handle out to close	\$99.95
TAILGATE HARDWARE		
21-0510-L	67-76 Tailgate Latch - fleetside, pair	\$49.95
21-510-R	67-72 Tailgate Rod - left & right, pair	\$23.95
21-0073-2	67-72 Tailgate Rod to Handle Insert - 3/16 tube nut, pair	\$1.35
21-510-I	67-72 Tailgate Rod Insulators - pair	\$2.00
21-510-GH	67-72 Tailgate Handle - black, w/ hdw	\$49.95
21-510-GHC	67-72 Tailgate Handle - chrome handle, w/ hdw	\$74.95
21-5806-HC	67-72 Handle Cover - stainless steel - fits original handles only, not reproduction handles	\$62.95
10-518-F	67-72 Tailgate Bumper Kit - 4 bumpers, w/ screws	\$12.95
10-510-HK	67-72 Tailgate Hardware Kit - 11 pcs	\$24.95



21-5FGMC



21-5FCHEV



21-510-G

21-0510-HK

21-510-H



21-510-AS-K

21-510-K



21-0510-L

21-510-GH



10-518-F

21-0073-2



10-510-HK

Part No.		Price
TAILGATE FLEETSIDE LETTERS DECAL		
21-5CWL	67-72 Tailgate Letters - white, CHEVROLET	\$9.95
21-5CBL	67-72 Tailgate Letters - black, CHEVROLET	\$9.95
21-5CSS	67-72 Tailgate Letters - brushed stainless finish, CHEVROLET	\$9.95
21-5GTWL	67-72 Tailgate Letters - white, GMC	\$9.95
21-5GBL	67-72 Tailgate Letters - black, GMC	\$9.95
21-5GSS	67-72 Tailgate Letters - brushed stainless finish, GMC	\$9.95
21-5DBD	Tailgate Decal - Chev, GMC, fleetside, DISC BRAKES	\$13.95
FLEETSIDE TAILGATE LINK ASSEMBLY		
21-0837	58-66 Fleetside Tailgate Link Assembly - plain steel - arms with hardware for removal of chains	\$169.95
21-0837-S	58-66 Fleetside Tailgate Link Assembly - stainless - arms with hardware for removal of chains	\$239.95
ROLL PANS		
Made from 18 gauge electro-galvanized steel & can be screwed or welded into place. Installation requires modification (cutting at plate box) to rear sill.		
21-5830-T	67-72 Rear Roll Pan - smooth, w/ license box, includes lights	\$249.95
21-5820-T	67-72 Rear Roll Pan - smooth, w/o license plate box	\$189.95
30-0204-T	47-87 Rear Roll Pan Tag Light - each	\$12.95
21-5684	67-72 Front Roll Pan - must cut 2" of frame to contact fenders - no light holes for 71-72 Chev park lights	\$214.95
21-5684-U	67-72 Front Roll Pan - must cut 2" of frame to contact fenders - no light holes for 71-72 Chev park lights, USA MADE	\$379.95
TRAILER HITCH		
Hidden tow hitch - receiver sits behind license plate		
22-572-HT	67-72 Trailer Hitch - w/ flip plate bracket, stock appearance. - can be used on step and fleetside trucks. Designed to meet a class 4 rating with a 500 lb tongue and 5000 lb pull capacity	\$399.95
22-0FLP	Flip Down Rear Plate Bracket	\$39.95

CHEVROLET
21-5CBL



21-5DBD



21-0837



21-5830-T



21-5820-T



30-0204-T



21-5684



22-572-HT



22-0FLP

Part No. **Price**

BEDSIDES

Bed sides are made from 16-gauge electro-galvanized steel and come with angels installed, stake pockets, and fender holes. USA made bedsides are not primed. Bed sides can be ordered with many different options: e.g., no pocket holes, stainless angels, no fender holes. Inquire for more details..

23-5643-T	67-72 Short Bedside - left, offshore	\$699.95
23-5644-T	67-72 Short Bedside - right, offshore	\$699.95
23-5550	67-72 Long Bedside - left, USA made	Special Order
23-5551	67-72 Long Bedside - right, USA made	Special Order

STAKE POCKETS

31-0405	54-72 Front Stake Pocket - left	\$99.95
31-0408	54-72 Front Stake Pocket - right	\$99.95
31-0597	67-76 Rear Stake Pocket - left	\$149.95
31-0598	67-76 Rear Stake Pocket - right	\$149.95

BED ROLL LIGHT

31-0864	Bed Roll Light Kit - LED lights, w/ hdw & instructions <i>- fits 40-66 stepside bed rolls & 40-87 Mar-K made bed rolls</i>	\$229.95
----------------	---	-----------------

BED ROLL PLUGS

23-0753	67-87 Bed Roll Plugs - polished aluminum, w/ milled bowtie, pair	\$83.95
----------------	--	----------------

STEPSIDE FRONT BED PANEL

23-0613	60-72 Front Bed Panel - USA Made, stepside	Inquire
23-0613-T	60-72 Front Bed Panel - stepside	\$169.95
23-0387-S	54-87 Front Bed Panel Bolt kit - wood floor, steel <i>- cap screws & philips drive screws, stepside & fleetside</i>	\$12.95
23-0387-SS	54-87 Front Bed Panel Bolt Kit - wood floor. stainless, <i>- pan head philips drive screws, stepside & fleetside</i>	\$19.95



23-5643-T



31-0405 31-0408 31-0597 31-0598



31-0864



23-0753



23-0613-T



23-0387-S

Part No.		Price
STEPSIDE CROSS SILLS		
Cross sills are pre-drilled with plates.		
SHORT step 3 x cross sills & 1 reinforcement		
LONG step 5 x cross sills & 1 reinforcement		
23-0429	63-72 Cross Sill - w/ holes & plates, galvanized, each	\$79.95
23-0431	60-72 Reinforcement Strip - galvanized, each - 49 1/2" between wheels	\$44.95
23-0522	67-87 Cross Sill Plates - stepside, each	\$5.00
23-5718-T	67-72 Rear Cross Sill - stepside	\$219.95
21-0722-HK	63-72 Rear Cross Sill Hardware Kit - stepside & fleetside	\$13.95
STEPSIDE TAILGATE		
23-0SCHEV-T	54-87 Stepside Tailgate - w/ CHEVROLET, Taiwan	\$429.95
23-0SBLANK	54-87 Stepside Tailgate - blank, Taiwan	\$249.95
23-0SGMC	54-87 Stepside Tailgate - w/ GMC, Taiwan	\$499.95
23-0694	54-87 Stepside Tailgate - w/ embossed bowtie, USA made	Special Order
23-0756	54-87 Stepside Tailgate - flush, w/ bowtie, USA made	Special Order
29-0679	54-87 Stepside Tailgate - w/ louvered, 4 row, 4" wide	Special Order
STEPSIDE TAILGATE LETTERS DECAL		
23-0CSW	54-87 Stepside Tailgate Letters - Chevrolet, white	\$9.95
23-0CSB	54-87 Stepside Tailgate Letters - Chevrolet, black	\$9.95
23-0CSC	54-87 Stepside Tailgate Letters - Chevrolet, chrome	\$9.95
23-0GSW	54-87 Stepside Tailgate Letters - GMC, white	\$9.95
23-0GSB	54-87 Stepside Tailgate Letters - GMC, black	\$9.95
23-0GSC	54-87 Stepside Tailgate Letters - GMC, chrome	\$9.95



Part No.		Price
TAILGATE TRUNNIONS		
22-0547-S	54-87 Tailgate Trunnions - cadmium plated, w/ bolts, pair	\$29.95
23-0381	54-87 Tailgate Trunnions - urethane, w/ stainless bolts, pair	\$52.95
TAILGATE CHAINS		
23-0SZ	54-87 Tailgate Chains - cadmium plated, pair	\$48.95
23-0SS	54-87 Tailgate Chains - stainless steel, pair	\$94.95
TAILGATE CHAIN COVERS		
22-0CCB	47-87 Tailgate Chain Covers - black, pair	\$11.95
22-0CCC	47-87 Tailgate Chain Covers - clear, pair	\$11.95
STEPSIDE TAILGATE EDGE PROTECTOR		
Screw or urethane to gate		
22-0STP	54-87 Stepside Edge Protector - brushed stainless steel	\$79.95
22-0STP-B	54-87 Stepside Edge Protector - satin black stainless steel	\$79.95
TAILGATE LINK ASSEMBLY		
29-0834	58-66 Stepside Tailgate Link Assembly - plain steel - arms with hardware for removal of chains	\$179.95
29-0834-S	58-66 Stepside Tailgate Link Assembly - stainless - arms with hardware for removal of chains	\$224.95
STEPSIDE STEALTH TAILGATE LATCHES		
Slotted barrel with spring loaded lock pin, Installs into the top gate roll and inserts in gate post.		
22-0SLK-S	47-72 Stealth Tailgate Latches - stainless	\$119.95
22-0SLK-Z	47-72 Stealth Tailgate Latches - zinc coated	\$94.95



Part No.		Price
STEPSIDE ROLL PANS		
Made from 18-gauge electro galvanized steel & can be screwed or welded into place		
24-0817	54-87 Stepside Roll Pan - smooth, w/o license box, USA made	Special Order
30-0826	54-87 Stepside Roll Pan - smooth, w/ license box, USA made	Special Order
30-0826-T	54-87 Stepside Roll Pan - smooth, w/ license box, Taiwan	\$224.95
24-0483	54-87 Stepside Roll Pan - long box, smooth w/ license box	\$279.95
24-0839	54-87 Stepside Roll Pan - 4 row louvered, w/o license box	\$239.95
30-0852	54-87 Stepside Roll Pan - 4 row louvered, w/ license box	\$279.95
STEPSIDE FENDERS		
25-505-67-L	67-67 Stepside Fender - w/o maker light, left	\$949.95
25-505-67-R	67-67 Stepside Fender - w/o marker light, right	\$949.95
25-505-68-L	68-72 Stepside Fender - w/o spare tire cut-out, left	\$949.95
25-505-68-R	68-72 Stepside Fender - right	\$949.95
25-505-K	67-72 Stepside Fender Brace Set - left or right, w/ hdw, pair - 2 required per fender	\$42.95
25-505-F	67-72 Fender Brace - front at step to frame, each	Inquire
25-505-R	67-72 Fender Brace - rear, left or right, each	Inquire
31-0FWB	47-72 Fender Welt Beading - black, 25' long, 3/16 bead - enough for both sides	\$19.95
25-06025	47-72 Stepside Rear Fender Bolt Kit - zinc, philips drive	\$26.95
25-0525-SS	55-72 Stepside Rear Fender Bolt Kit - stainless, philips drive	\$49.95
BEDSIDE FENDER STEPS		
25-510-LS	67-72 Bedside Short Step - left	\$149.95
25-510-RS	67-72 Bedside Short Step - right	\$149.95
25-510-LLS	67-72 Bedside Long Step - w/ 27" vertical, left	Inquire
25-510-RLS	67-72 Bedside Long Step - w/ 27" vertical, right	Inquire
25-510-LB	67-72 Bedside Step Bracket - long & short, left	\$69.95
25-510-RB	67-72 Bedside Step Bracket - long & short, right	\$69.95
25-0510-BK	55-72 Bedside Step Bolt Kit - zinc	\$29.95
25-0510-BKS	55-72 Bedside Step Bolt Kit - chrome	\$32.95
32-004	47-87 Running Board Step Plates - polished aluminum, w/ hdw - diamond pattern & bowtie logo in center	\$99.95



Part No.		Price
BED WOOD		
Top show quality OAK, kiln dried, cut to size, sanded and grooved for bed strips 3/4" thick without mount holes.		
OAK		
26-0240	60-72 Short Step	\$654.95
26-0256	60-72 Long Step	\$659.95
26-5266	67-72 Long Step - w/ pre drilled mount holes, special order	Inquire
26-0262	60-72 Short Fleet	\$824.95
26-0266	60-72 Long Fleet	\$964.95
26-5220	67-72 Long Fleet - w/ pre drilled mount holes, special order	Inquire
26-5222	60-72 Longhorn - special order	Special Order
PINE		
26-0257	60-72 Long Step - pine	Special Order
26-0263	60-72 Short Fleet - pine	Special Order
26-0263	60-72 Long Fleet - pine	Special Order
EXHAUST HEAT SHIELD		
26-0734	47-87 Exhaust Heat Shield - w/ hdw, each	\$33.95
BED STRIPS		
Available in cold rolled steel or (430 grade) polished stainless steel pre-punched with square holes. When installing the bed and angle strip bolts do not over tighten and collapse the lock washer only. The bed strips will collapse when they are over tightened.		
STEEL		
26-5024	67-72 Short Stepside - steel	\$139.95
26-5066	67-72 Long Stepside - steel	\$149.95
26-5078	67-72 Short Fleetside - steel	\$179.95
26-5093	67-72 Long Fleetside - steel	\$249.95
26-5102	67-72 Longhorn - 103", steel	\$279.95
POLISHED STAINLESS STEEL		
26-5022	67-72 Short Stepside - 7pcs, polished stainless	\$299.95
26-5064	67-72 Long Stepside - 7pcs, polished stainless	\$324.95
26-5076	67-72 Short Fleetside - polished stainless	\$329.95
26-5091	67-72 Long Fleetside - polished stainless	\$369.95
26-5100	67-72 Longhorn - 103", polished stainless	\$399.95



26-0240

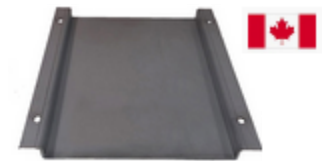

26-0734



26-5024



26-5022

Part No. **Price**

WOW BED STRIPS (hidden fasteners)

"WOW" Strips maintain the shape and contour of original strips but have a sliding "T" bolt type of fastener on the bottom of the strip. This system fully duplicates all the strength of the original strips without exposed fasteners.

26-0083-K	"WOW" Strip Kit - 7 strips 82" long w/ T bolts & angle hardware	\$699.95
26-0083	"WOW" Stipe - 82" long, stainless, (cut to fit), each	\$99.00
26-0095	"T" bolt - w/ hardware, stainless, each	\$6.00

COMPLETE HIDDEN BED STRIP KIT

26-5091-HB	67-72 Hidden Bed Strip Kit - long bed fleetside, - polished stainless steel, all hdw included	\$1199.95
-------------------	--	------------------

BED STRIPS WITHOUT HOLES

26-0008	Steel - 97" long, w/o holes, each	\$39.95
26-0383	Steel - 120" long, w/o holes, each	\$59.95
26-0634	Polished Stainless - 78" long, w/o holes, each	\$44.95
26-0160	Polished Stainless - 89" long, w/o holes, each	\$59.95

ANGLE STRIPS

Pre-punched, welded or bolted to sides, pair

STEEL

26-5120	67-72 Short Stepside - pair	\$59.95
26-5156	67-72 Long Stepside - pair	\$69.95

POLISHED STAINLESS STEEL

26-5118	67-72 Short Stepside - pair	\$84.95
26-5154	67-72 Long Stepside - pair	\$104.95
26-5155	67-72 Long Stepside - un-polished stainless steel, pair	\$99.95



Part No. Price

BED BOLT KITS

Includes all bolts, washers & nuts for bed strips and for mounting bed to frame,
Available in zinc & polished stainless steel

ZINC

26-5365	67-72 Short Stepside - zinc	\$84.95
26-5299	67-72 Long Stepside - zinc	\$89.95
26-5311	67-72 Short Fleetside - zinc	\$104.95
26-5323	67-72 Long Fleetside - zinc	\$109.95
26-5326	67-72 Longhorn Fleetside - zinc	\$119.95

POLISHED STAINLESS STEEL

26-5363	67-72 Short Stepside - polished stainless steel	\$199.95
26-5297	67-72 Long Stepside - polished stainless steel	\$209.95
26-5309	67-72 Short Fleetside - polished stainless steel	\$229.95
26-5321	67-72 Long Fleetside - polished stainless steel	\$279.95
26-5324	67-72 Longhorn Fleetside - polished stainless steel	\$289.95

BED TO FRAME BOLT KIT

26-0617	60-72 Bed To Frame Bolt Kit - stainless - short or long bed, stepside or fleetside	\$104.95
---------	---	----------

BED MOUNTING PADS

31-0201-P	54-72 Bed Mount Pads - rubber, 10pcs	\$14.95
-----------	--------------------------------------	---------

BED FLOOR OFFSET WASHER

28-0211	Offset Washer - 1 1/2" w/ offset 1/2" square hole, each - polished stainless steel	\$12.95
---------	---	---------

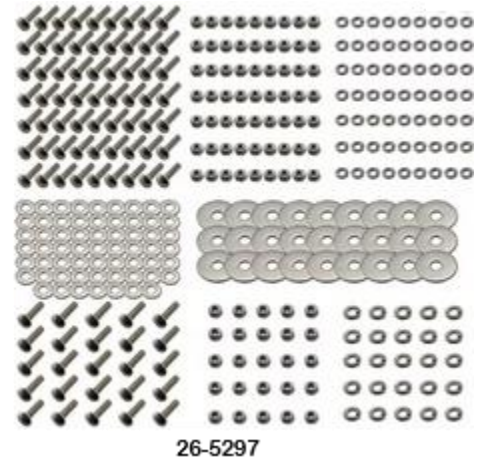

26-5297



26-0617



28-0211



31-0201-P



Part No.		Price
CAB FLOOR		
27-5221-CL	67-72 Cab Floor - complete, low tunnel - with front and rear cab supports & braces, inner rockers, seat belt anchors	\$999.95
27-5221-C	67-72 Cab Floor - complete, w/ open trans tunnel - with front and rear cab supports & braces, inner rockers, seat belt anchors	\$1150.00
27-5221-HH	67-72 Transmission Floor Cover - w/ high hump floor - can also be used to covert low hump floor to high hump	\$219.95
CAB FLOOR SUPPORTS		
27-5319	67-72 Cab Floor Support - front to rear, left	\$129.95
27-5320	67-72 Cab Floor Support - front to rear, right	\$129.95
27-5309-L	67-72 Front Cab Support - OE design, left	\$34.95
27-5309-R	67-72 Front Cab Support - OE design, right	\$34.95
27-5309	67-72 Front Cab Support - fits left or right, each	\$29.95
27-0307	60-72 Rear Cab Floor Support - OE style, w/ seat belt nut, left	\$43.95
27-0308	60-72 Rear Cab Floor Support - OE style, w/ seat belt nut, right	\$43.95
27-5310	Rear Cab Floor Crossmember - side to side - side to side under gas tank including rear outer cab supports, welds to cab floor, includes seat belt anchors.	\$249.95
28-5857	69-72 Centre Transverse Floor Support - for factory bucket seats - fits pickup, blazer, suburban. Not for factory buddy buckets	\$269.95
REAR CAB FLOOR		
27-5233	67-72 Rear Cab Floor - 27" long x 10" wide, left - from inner rocker in under fuel tank	\$99.95
27-5234	67-72 Rear Cab Floor - 27" long x 10" wide, right - from inner rocker in under fuel tank	\$99.95
Applies to 3/4 ton & up, & 4x4		
27-5232-L	67-72 Rear Cab Brace - cab floor to rear of cab, left	\$74.95
27-5232-R	67-72 Rear Cab Brace - cab floor to rear of cab, right	\$74.95



Part No.		Price
ROCKER PANELS		
27-5101	67-72 Rocker Panel - original style, left	\$62.95
27-5102	67-72 Rocker Panel original style, right	\$62.95
27-0301	60-72 Rocker Panel Backing Plate - left or right, each	\$19.95
OUTER CAB FLOOR & INNER ROCKER		
27-5227	67-72 Cab Floor Outer w/ Inner Rocker - 4" wide, left - front to rear of cab	\$139.95
27-5228	67-72 Cab Floor Outer w/ Inner Rocker - 4" wide, right - front to rear of cab	\$139.95
INNER FOOTWELL / KICKPANEL		
27-5225	67-72 Footwell / Kick Panel - 9" high, left	\$44.95
27-5226	67-72 Footwell / Kick Panel - 9" high, right	\$44.95
27-5225-T	67-72 Footwell / Kick Panel - tall, 23" high, left	\$104.95
27-5226-T	67-72 Footwell / Kick Panel - tall, 23" high, right	\$104.95
FLOOR PAN		
NEW restoration quality floor pans		
27-5221-A	67-72 Front Floor Pan - restoration quality, left	\$89.95
27-5222-A	67-72 Front Floor Pan - restoration quality, right	\$89.95
27-5221	67-72 Front Floor Pan - left	\$49.95
27-5222	67-72 Front Floor Pan - right	\$49.95
27-5223	67-72 Floor Outer Rear & Rear Cab Support - 28" x 7" left	\$49.95
27-5224	67-72 Floor Outer Rear & Rear Cab Support - 28" x 7" right	\$49.95
REAR CAB WALL		
27-5217	67-67 Rear Cab Outer - w/ small back window	\$1449.95
27-5218	68-72 Rear Cab Outer - w/o cab light hole	\$1449.95
27-5219	68-72 Rear Cab Outer - w/ cab light hole	\$1449.95
27-5330	67-67 Rear Cab Inner - w/ small back window	\$599.95
27-5331	67-72 Rear Cab Inner - w/ big back window	\$599.95
CAB (Complete)		
27-5LHAC-68	68-71 Cab - low hump floor, A/C, includes doors	Inquire
27-5LHAC-72	72-72 Cab - low hump floor, A/C, includes doors	Inquire



27-5101



27-0301



27-5227

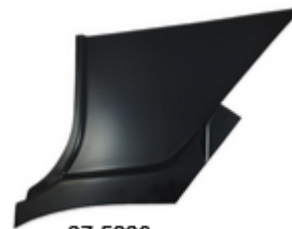

27-5226



27-5221-A

gm restoration



27-5225-T



27-5223



27-5226-T



27-5217



27-5331



27-5219



Part No.		Price
DOOR PILLARS		
27-5211	67-72 Front Lower Door "A" Pillar - 9" high, left	\$24.95
27-5212	67-72 Front Lower Door "A" Pillar - 9" high, right	\$24.95
27-5211-E	67-72 Front Lower Door "A" Pillar - left - extended w/ hinge nut plate	\$69.95
27-5212-E	67-72 Front Lower Door "A" Pillar - right - extended w/ hinge nut plate	\$69.95
27-5213	67-72 Rear Cab Door "B" Pillar - 12" high, left	\$24.95
27-5214	67-72 Rear Cab Door "B" Pillar - 12" high, right	\$24.95
<i>Below pillars are special order</i>		
27-5087	67-72 Pillar "A" - complete assembly, w/ vent, left	\$1150.00
27-5088	67-72 Pillar "A" - complete assembly, w/ vent, right	\$1150.00
27-5085	67-72 Pillar Outer "A" pillar - left	\$614.95
27-5086	67-72 Pillar Outer "A" pillar - right	\$614.95
27-5089	67-70 Pillar "B" - left	\$549.95
27-5089-71	71-72 Pillar "B" - w/ vent cut out, left	\$549.95
27-5090	67-72 Pillar "B" - right	\$549.95
CAB CORNERS		
27-5115	67-72 Cab Corner - 18" W x 14" H, left	\$49.95
27-5116	67-72 Cab Corner - 18" W x 14" H, right	\$49.95
DOOR SKINS		
27-5169	67-72 Full Door Skin - left	\$129.95
27-5170	67-72 Full Door Skin - right	\$129.95
27-5171	67-72 Outer Door Skin - 9" high, left	\$42.95
27-5172	67-72 Outer Door Skin - 9" high, right	\$42.95
INSIDE DOOR BOTTOMS		
27-5271	67-72 Inside Door Bottom - OE style, 13" high, left	\$94.95
27-5272	67-72 Inside Door Bottom - OE style, 13" high, right	\$94.95

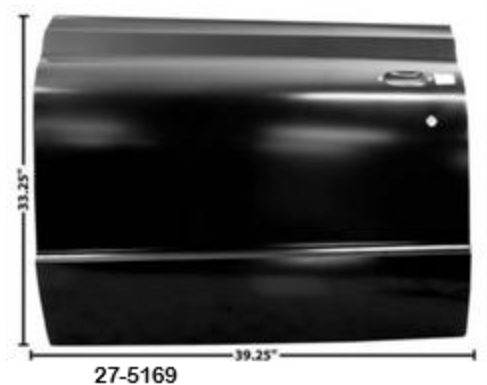
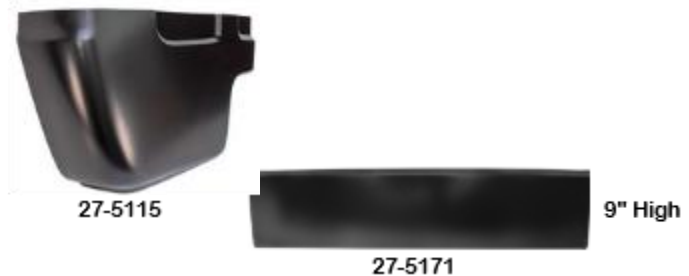
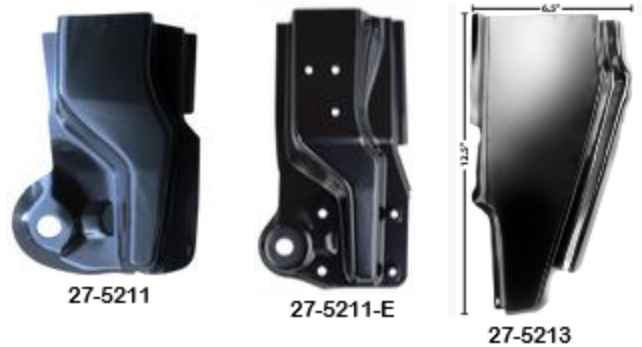

Part No.		Price
FIREWALLS		
27-5118	67-72 Firewall Upper Cowl Panel	\$679.95
27-5113	67-72 Firewall Lower Inner Cowl Panel	\$414.95
27-5229	67-68 Firewall - w/ toe board, w/o A/C	\$359.95
27-5229-AC	67-68 Firewall - w/ toe board, w/ factory A/C - must trim trans tunnel for big block & 4x4	Inquire
27-5230	69-72 Firewall - w/ toe board, w/o A/C	\$374.95
27-5230-AC	69-72 Firewall - w/ toe board, w/ factory A/C	Inquire
FRONT CAB FLOOR BRACE		
27-5317	67-72 Front Cab Floor Brace - firewall to floor, left - inner fender secures to this brace, fits pickup, blazer, suburban	\$49.95
27-5318	67-72 Front Cab Floor Brace - firewall to floor, right - inner fender secures to this brace, fits pickup, blazer, suburban	\$54.95
DASH PANEL		
27-5350	67-72 Dash Radio Repair Panel	\$99.95
27-5380	68-68 Dash Panel - w/ A/C	\$769.95
27-5381	68-68 Dash panel - w/o A/C	\$769.95
27-5382	69-72 Dash Panel - w/ A/C	\$769.95
27-5383	69-72 Dash Panel - w/o A/C	\$769.95
ROOF RAIL BRIDGES		
27-5611	67-72 Roof Rail Bridges - left - "A" and "B" pillar under roof skin	\$154.95
27-5612	67-72 Roof Rail Bridges -right - "A" and "B" pillar under roof skin	\$154.95
ROOF REPAIR PANELS		
Confirm embossed mirror support area or smooth		
27-5260-67	67-69 & 72 Inner Front Roof Panel - w/o mirror support holes - approximately 7" wide	\$169.95
27-5260U	67-72 Inner Front Roof Panel - w/ raised mirror mount - approximately 7" wide	\$169.95
27-5261	67-72 Outer Front Roof Panel - drip rail to windshield pinch weld - lower replacement panel between end pillars	\$99.95
27-5112	67-72 Outer Roof Panel	\$469.95
27-5119	67-72 Inner Roof Panel - w/o headliner trim holes	\$569.95



Part No.		Price
DRIP RAILS		
27-5157	67-72 Drip Rail - 40" long, left	\$54.95
27-5158	67-72 Drip Rail - 40" long, right	\$54.95
FRONT FENDER REPAIR PANEL		
27-5167	67-72 Front Fender Rear Lower - 14" high, left	\$59.95
27-5168	67-72 Front Fender Rear Lower - 14" high, right	\$59.95
<p>The upper area of the front fender cups is stamped 67-68 Chev & 67-72 GMC. For 69-72 Chev application some trim is necessary below grille recess.</p>		
27-5164	67-72 Front Fender Front Lower Cup - 6" high, right	\$144.95
27-5165	67-72 Front Fender Front Lower Cup - 6" high, left	\$144.95
BED WHEEL ARCH		
27-5147	67-72 Wheel Arch - 35" long x 14" high, left <i>- also fits suburban</i>	\$56.95
27-5148	67-72 Wheel Arch - 35" long x 14" high, right <i>- also fits suburban</i>	\$56.95
27-5125	67-72 Wheel Arch Extended - 64" long x 25" high, left	\$299.95
27-5126	67-72 Wheel Arch Extended - 64" long x 25" high, right	\$299.95
27-5327	67-72 Inner Wheel Arch - w/ wheel tub mounting nuts, left	\$169.95
27-5328	67-72 Inner Wheel Arch - w/ wheel tub mounting nuts, right	\$169.95
BED SIDE REPAIR PANEL		
27-5141	67-72 Bed Front Lower - long bed, 41" long x 15" high, left	\$54.95
27-5142	67-72 Bed Front Lower - long bed, 41" long x 15" high, right	\$54.95
27-5145	67-72 Bed Front Lower - short bed, 28" long x 13" high, left	\$129.95
27-5146	67-72 Bed Front Lower - short bed, 28" long x 13" high, right	\$129.95
27-5133	67-72 Bed Rear Lower - long bed, 34" long x 14" high, left	\$79.95
27-5134	67-72 Bed Rear Lower - long bed, 34" long x 14" high, right	\$79.95

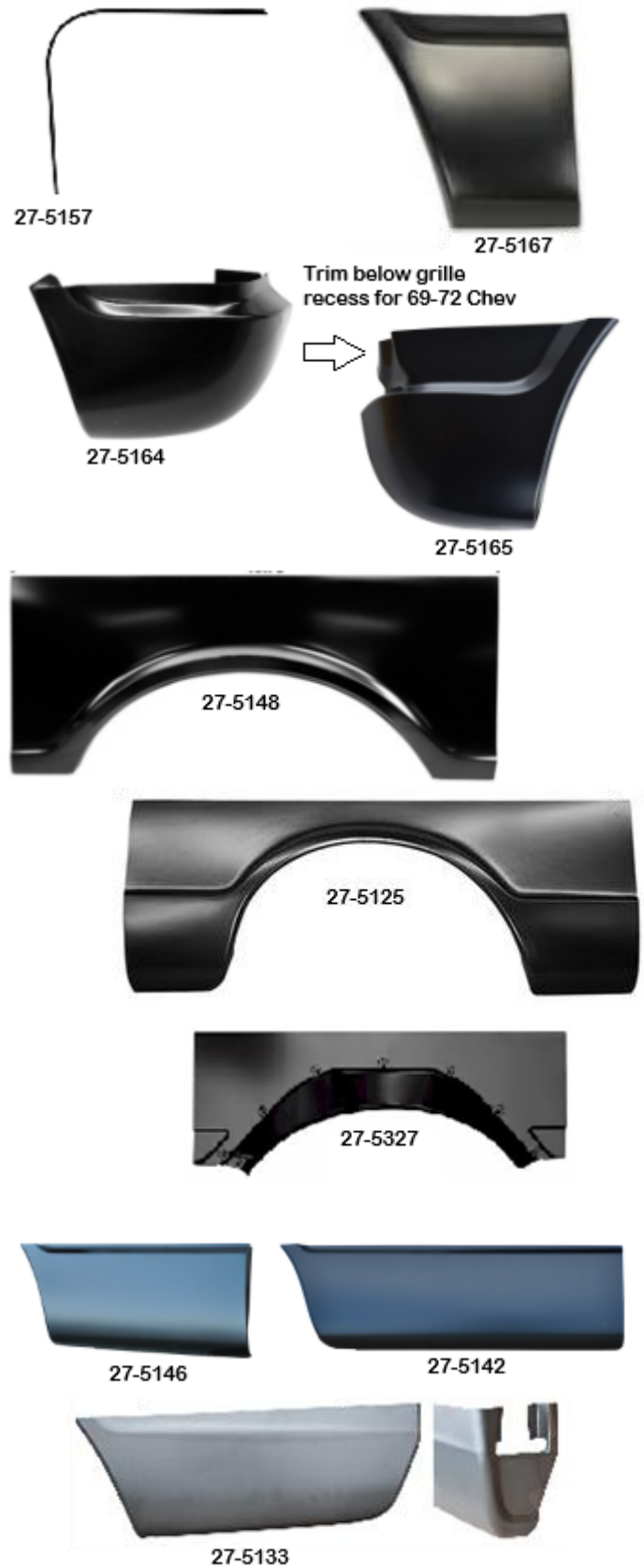

Part No.		Price
ROCKER PANEL		
27-5104	67-72 3 rd Door Rocker Panel - (<i>suburban</i>), each	\$89.95
LOWER REAR QUARTER PANEL		
27-5133-S	67-72 Rear Lower Quarter - (<i>suburban</i>), 10" high, left	\$169.95
27-5134-S	67-72 Rear Lower Quarter - (<i>suburban</i>), 10" high, right	\$169.95
TAILLIGHT CORNER		
27-5135-S	67-72 Taillight Corner - (<i>suburban</i>), left	\$169.95
27-5136-S	67-72 Taillight Corner - (<i>suburban</i>), right	\$169.95
LOWER FRONT QUARTER PANEL		
27-5137	67-72 Front Lower Quarter - (<i>suburban</i>), 57" L x 20" H, left - door to wheel opening	\$189.95
27-5138	67-72 Front Lower Quarter - (<i>suburban</i>), 24" L x 20" H, right - behind door to wheel opening	\$169.95
WHEEL ARCHES		
<i>Note - can use 27-5147 & 27-5148 (pg. 123) wheel arches</i>		
CAB FLOOR		
27-5221-PS	67-72 Cab Floor - w/o rear braces, w/ low hump floor - panel, <i>suburban</i>	\$699.95



27-5104



27-5106-S



27-5134-S



27-5135-S



27-5138



27-5137



27-5148



27-5221-PS

Part No.		Price
BLAZER ROCKER BOXES		
27-5107-B	69-72 Rocker Box End Cap - left	\$79.95
27-5108-B	69-72 Rocker Box End Cap - right	\$79.95
27-5105-B	69-72 Rocker Box - left	\$234.95
27-5106-B	69-72 Rocker Box - right	\$234.95
27-5111-L	69-72 Rocker Box Reinforcement - left	\$219.95
27-5111-R	69-72 Rocker Box Reinforcement - right	\$219.95
REAR CAB SUPPORT		
27-5110-L	69-72 Rear Cab Support - 16-gauge steel, left	\$59.95
27-5110-R	69-72 Rear Cab Support - 16-gauge steel, right	\$59.95
DOOR PILLAR		
27-5114-L	69-72 "B" Pillar - lower inner, 16-gauge steel, left	\$224.95
27-5114-R	69-72 "B" Pillar - lower inner, 16-gauge steel, right	\$224.95
A-PILLAR ASSEMBLY		
27-5185	69-72 Outer "A" Pillar - w/o inner kick panel and cowl, left - also fits pick-up	\$649.95
27-5186	69-72 Outer "A" Pillar - w/o inner kick panel and cowl, right - also fits pick-up	\$649.95
27-5187	69-72 Outer "A" Pillar - w/ inner kick panel and cowl, left - also fits pick-up	\$949.95
27-5188	69-72 Outer "A" Pillar - w/ inner kick panel and cowl, right - also fits pick-up	\$949.95
CAB FLOOR		
<i>Blazer & Jimmy floors do not include rocker boxes</i>		
27-5115-F	69-72 Complete Floor - w/ removable trans cover - also with bucket seat mount nuts	\$1114.95
27-5115-LHF	69-72 Complete Floor - w /low hump floor - also with bucket seat mount nuts	\$1199.95
27-5115-S	69-72 Step up panel - cab floor to bed floor	\$269.95



Part No.		Price
BED FLOOR		
27-5117-F	69-72 Bed floor - complete replacement, w/ all cross sills	\$1699.00
27-5117-A	69-72 Bed Cross Sill - front	Inquire
27-5117-B	69-72 Bed Cross Reinforcement Strip - front	Inquire
27-5117-C	69-72 Bed Cross Reinforcement Strip - center	\$54.95
27-5117-D	69-72 Bed Cross Reinforcement Strip - center	Inquire
27-5117-E	69-72 Bed Cross Reinforcement Strip - rear	Inquire
27-5117-ES	69-72 Support / Spacer - galvanized, w/ hdw, pair - supports stone shield to reinforcement	\$29.95
27-5117-R	69-72 Bed Rear Cross Sill - rear	\$209.95
27-5095	67-72 Bed Floor Rear Replacement - 42" deep - for short bed truck & blazer rear	\$374.95
27-5098	67-72 Bed Floor Repair Section - across rear, 15" wide	\$199.95
BED SIDES		
21-5BL-L	69-72 Bed Side - left	\$1099.00
21-5BL-R	69-72 Bed Side - right	\$1099.00
LOWER FRONT BED QUARTER PANEL		
27-5113-L	69-72 Lower Front Bed ¼ Panel - to post, left	\$109.95
27-5114-R	69-72 Lower Front Bed ¼ Panel - to post, right	\$109.95
GAS FILLER		
27-5795	69-72 Gas Filler Cover - bed side	\$56.95
WINDSHIELD HEADER KIT		
27-5120	69-72 Windshield Header Kit - 5 pc	\$274.95
BODY		
27-51BJ	69-72 Blazer / Jimmy Body Includes: - high hump transmission cover - blank tailgate Not included: - dash panel - doors (add 69-71 or 72 doors)	\$18999.95

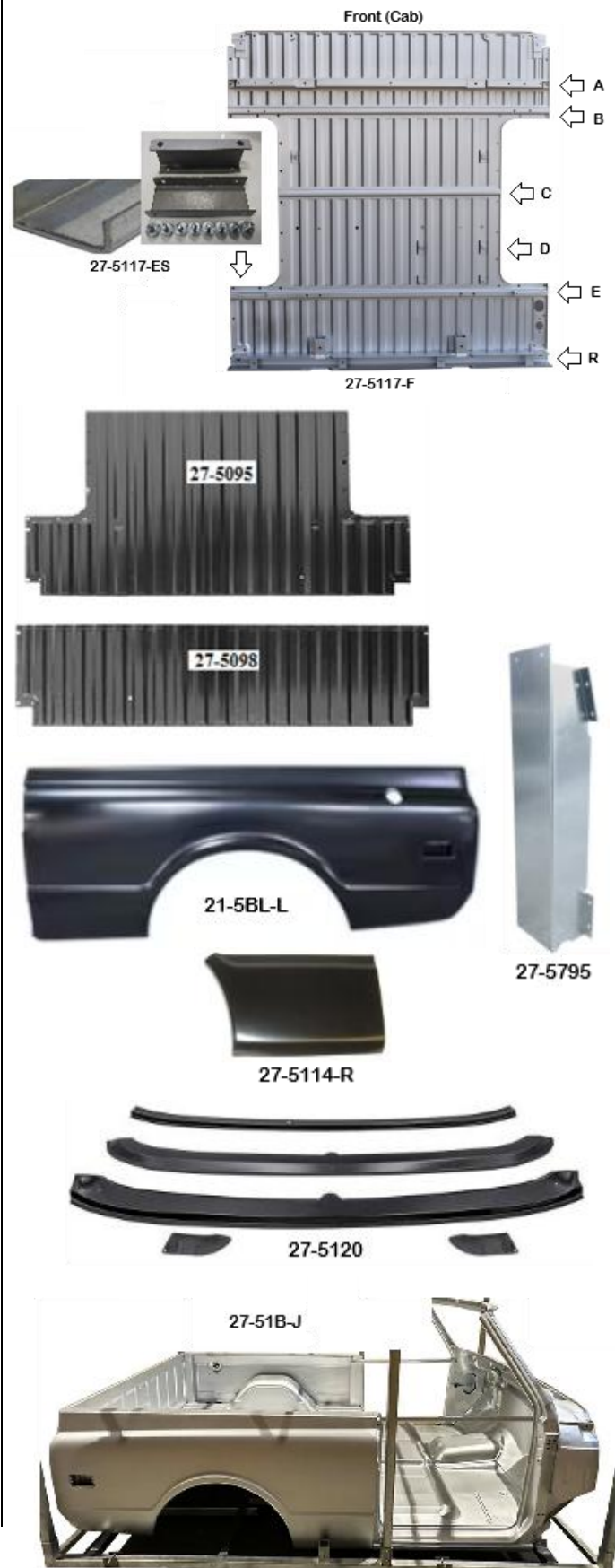

Part No. **Price**

69-70 used push in retainers, 71-72 used push in & stick-on retainers, note which retainers are required

67-68 SIDE MOULDINGS

Mouldings have black accent in center

28-5251	67-68 Fender Wheel - left	Inquire
28-5252	67-68 Fender Wheel - right	Inquire
28-5235	67-68 Door - left	Inquire
28-5234	67-68 Door - right	Inquire
28-5237	67-68 Cab - left	Inquire
28-5236	67-68 Cab - right	Inquire
28-5239	67-68 Bed Front - short bed, left	Inquire
28-5240	67-68 Bed Front - short bed, right	Inquire
28-5241	67-68 Bed Front - long bed, left	Inquire
28-5242	67-68 Bed Front - long bed, right	Inquire
28-5243	67-68 Bed Wheel - left	Inquire
28-5244	67-68 Bed Wheel - right	Inquire
28-5245	67-68 Bed Rear - short bed, left	Inquire
28-5246	67-68 Bed Rear - short bed, right	Inquire
28-5247	67-68 Bed Rear - long bed, left	Inquire
28-5248	67-68 Bed Rear - long bed, right	Inquire
28-5136	67-68 Side Moulding Kit - short bed, w/ hdw, US made	Special Order
28-5137	67-68 Side Moulding Kit - long bed, w/ hdw, US made	Special Order
28-5136-T	67-68 Side Moulding Kit - short bed, w/ hdw, Taiwan made	\$1294.95
28-5137-T	67-68 Side Moulding Kit - long bed, w/ hdw, Taiwan made	\$1394.95

67-68 SUBURBAN SIDE MOULDINGS

67-68 Suburban front of cab & front fender side mouldings are the same as pickup

28-5075	67-68 Bed Front Lower - left	Inquire
28-5080	67-68 Bed Front Lower - behind 3 rd door, right (suburban only)	Inquire
28-5076	67-68 Bed Front Lower - right, (panel truck only)	Inquire
28-5243	67-68 Bed Wheel Arch - left	Inquire
28-5244	67-68 Bed Wheel Arch - right	Inquire
28-5077	67-68 Bed Rear - left	Inquire
28-5078	67-68 Bed Rear - right	Inquire
28-5079	67-68 2 nd Door - right	Inquire
28-5139	67-68 Body Side Moulding Kit - suburban, 11pc set	Inquire
28-5140	67-68 Body Side Moulding kit - panel truck	Inquire



28-5136-T



28-5137-T

Part No.		Price
69-72 LOWER SIDE MOULDINGS		
All mouldings are US made unless noted with "T" Taiwan		
<i>69-72 front fender lower also fit blazer, jimmy, suburban & panel</i>		
28-5401	69-72 Front Fender Lower Front - black, left <i>- also fits blazer, jimmy, suburban, panel</i>	Inquire
28-5401-T	69-72 Front Fender Lower Front - black, left, Taiwan <i>- also fits blazer, jimmy, suburban, panel</i>	Inquire
28-5301	69-72 Front Fender Lower Front - wood, left <i>- also fits blazer, jimmy, suburban, panel</i>	Inquire
28-5301-T	69-72 Front Fender Lower Front - wood, left, Taiwan <i>- also fits blazer, jimmy, suburban, panel</i>	Inquire
28-5402	69-72 Front Fender Lower Front - black, right <i>- also fits blazer, jimmy, suburban, panel</i>	Inquire
28-5402-T	69-72 Front Fender Lower Front - black, right, Taiwan <i>- also fits blazer, jimmy, suburban, panel</i>	Inquire
28-5302	69-72 Front Fender Lower Front - wood, right <i>- also fits blazer, jimmy, suburban, panel</i>	Inquire
28-5302-T	69-72 Front Fender Lower Front - wood, right, Taiwan <i>- also fits blazer, jimmy, suburban, panel</i>	Inquire
28-5403	69-72 Front Fender Lower Rear - black, left <i>- also fits blazer, jimmy, suburban, panel</i>	Inquire
28-5403-T	69-72 Front Fender Lower Rear - black, left, Taiwan <i>- also fits blazer, jimmy, suburban, panel</i>	Inquire
28-5303	69-72 Front Fender Lower Rear - wood, left <i>- also fits blazer, jimmy, suburban, panel</i>	Inquire
28-5303-T	69-72 Front Fender Lower Rear - wood, left, Taiwan <i>- also fits blazer, jimmy, suburban, panel</i>	Inquire
28-5404	69-72 Front Fender Lower Rear - black, right <i>- also fits blazer, jimmy, suburban, panel</i>	Inquire
28-5404-T	69-72 Front Fender Lower Rear - black, right, Taiwan <i>- also fits blazer, jimmy, suburban, panel</i>	Inquire
28-5304	69-72 Front Fender Lower Rear - wood, right <i>- also fits blazer, jimmy, suburban, panel</i>	Inquire
28-5304-T	69-72 Front Fender Lower Rear - wood, right, Taiwan <i>- also fits blazer, jimmy, suburban, panel</i>	Inquire



28-5402-T



28-5302-T



28-5403-T



28-5303-T

Part No.		Price
69-72 LOWER SIDE MOULDINGS (cont.)		
<i>69-72 lower door mouldings also fit blazer, jimmy, suburban & panel</i>		
28-5405	69-72 Door Lower - black, left <i>- also fits blazer, jimmy, suburban, panel</i>	Inquire
28-5405-T	69-72 Door Lower - black, left, Taiwan <i>- also fits blazer, jimmy, suburban, panel</i>	Inquire
28-5305	69-72 Door Lower - wood, left <i>- also fits blazer, jimmy, suburban, panel</i>	Inquire
28-5305-T	69-72 Door Lower - wood, left, Taiwan <i>- also fits blazer, jimmy, suburban, panel</i>	Inquire
28-5406	69-72 Door Lower - black, right <i>- also fits blazer, jimmy, suburban, panel</i>	Inquire
28-5406-T	69-72 Door Lower - black, right, Taiwan <i>- also fits blazer, jimmy, suburban, panel</i>	Inquire
28-5306	69-72 Door Lower - wood, right <i>- also fits blazer, jimmy, suburban, panel</i>	Inquire
28-5306-T	69-72 Door Lower - wood, right, Taiwan <i>- also fits blazer, jimmy, suburban, panel</i>	Inquire
28-5407	69-72 Cab Lower - black, left	Inquire
28-5407-T	69-72 Cab Lower - black, left, Taiwan	Inquire
28-5307	69-72 Cab Lower - wood, left	Inquire
28-5307-T	69-72 Cab Lower - wood, left, Taiwan	Inquire
28-5408	69-72 Cab Lower - black, right	Inquire
28-5408-T	69-72 Cab Lower - black, right, Taiwan	Inquire
28-5308	69-72 Cab Lower - wood, right	Inquire
28-5308-T	69-72 Cab Lower - wood, right, Taiwan	Inquire
69-72 SHORT BEDSIDE LOWER MOULDINGS		
28-5411	69-72 Bed Lower Front - short bed, black, left	Inquire
28-5411-T	69-72 Bed Lower Front - short bed, black, left, Taiwan	Inquire
28-5311	69-72 Bed Lower Front - short bed, wood, left	Inquire
28-5311-T	69-72 Bed Lower Front - short bed, wood, left, Taiwan	Inquire
28-5412	69-72 Bed Lower Front - short bed, black, right	Inquire
28-5412-T	69-72 Bed Lower Front - short bed, black, right, Taiwan	Inquire
28-5312	69-72 Bed Lower Front - short bed, wood, right	Inquire
28-5312-T	69-72 Bed Lower Front - short bed, wood, right Taiwan	Inquire



28-5405-T



28-5305-T



28-5307-T



28-5412-T

Part No.		Price
69-72 SHORT BEDSIDE LOWER MOULDINGS (cont.)		
<i>short bed lower rears also fit blazer & jimmy</i>		
28-5413	69-72 Bed Lower Rear - short bed, black, left - also fits blazer, jimmy	Inquire
28-5413-T	69-72 Bed Lower Rear - short bed, black, left, Taiwan - also fits blazer, jimmy	Inquire
28-5313	69-72 Bed Lower Rear - short bed, wood, left - also fits blazer, jimmy	Inquire
28-5313-T	69-72 Bed Lower Rear - short bed, wood, left, Taiwan - also fits blazer, jimmy	Inquire
28-5414	69-72 Bed Lower Rear - short bed, black, right - also fits blazer, jimmy	Inquire
28-5414-T	69-72 Bed Lower Rear - short bed, black, right, Taiwan - also fits blazer, jimmy	Inquire
28-5314	69-72 Bed Lower Rear - short bed, wood, right - also fits blazer, jimmy	Inquire
28-5314-T	69-72 Bed Lower Rear - short bed, wood, right Taiwan - also fits blazer, jimmy	Inquire



28-5413-T



28-5313-T

69-72 LONG BEDSIDE LOWER MOULDINGS		
28-5415	69-72 Bed Lower Front - long bed, black, left	Inquire
28-5415-T	69-72 Bed Lower Front - long bed, black, left, Taiwan	Inquire
28-5315	69-72 Bed Lower Front - long bed, wood, left	Inquire
28-5315-T	69-72 Bed Lower Front - long bed, wood, left, Taiwan	Inquire
28-5416	69-72 Bed Lower Front - long bed, black, right	Inquire
28-5416-T	69-72 Bed Lower Front - long bed, black, right, Taiwan	Inquire
28-5316	69-72 Bed Lower Front - long bed, wood, right	Inquire
28-5316-T	69-72 Bed Lower Front - long bed, wood, right, Taiwan	Inquire
28-5421	69-72 Bed Lower Front - longhorn, black, left	Inquire
28-5321	69-72 Bed Lower Front - longhorn, wood, left	Inquire
28-5422	69-72 Bed Lower Front - longhorn, black, right	Inquire
28-5322	69-72 Bed Lower Front - longhorn, wood, right	Inquire



Part No.		Price
69-72 LONG BEDSIDE LOWER MOULDINGS (cont.)		
<i>Lower long bed rear mouldings also fit longhorn beds</i>		
28-5417	69-72 Bed Lower Rear - long bed, longhorn, black, left	Inquire
28-5417-T	69-72 Bed Lower Rear - long bed, longhorn, black, left, Taiwan	Inquire
28-5317	69-72 Bed Lower Rear - long bed, longhorn, wood, left	Inquire
28-5317-T	69-72 Bed Lower Rear - long bed, longhorn, wood, left, Taiwan	Inquire
28-5418	69-72 Bed Lower Rear - long bed, longhorn, black, right	Inquire
28-5418-T	69-72 Bed Lower Rear - long bed, longhorn, black, right, Taiwan	Inquire
28-5318	69-72 Bed Lower Rear - long bed, longhorn, wood, right	Inquire
28-5318-T	69-72 Bed Lower Rear - long bed, longhorn, wood, right, Taiwan	Inquire
69-72 BLAZER & JIMMY LOWER MOULDINGS		
28-5481	69-72 Bed Lower Front - blazer, black, left	Inquire
28-5481-T	69-72 Bed Lower Front - blazer, black, left, Taiwan	Inquire
28-5383	69-72 Bed Lower Front - blazer, wood, left	Inquire
28-5383-T	69-72 Bed Lower Front - blazer, wood, left, Taiwan	Inquire
28-5482	69-72 Bed Lower Front - blazer, black, right	Inquire
28-5482-T	69-72 Bed Lower Front - blazer, black, right, Taiwan	Inquire
28-5384	69-72 Bed Lower Front - blazer, wood, right	Inquire
28-5384-T	69-72 Bed Lower Front - blazer, wood, right, Taiwan	Inquire
69-72 UPPER SIDE MOULDINGS		
28-5500-LR	69-72 Fender Upper - left & right	Inquire
28-5500-LRT	69-72 Fender Upper - left & right, Taiwan	Inquire
28-5501	69-72 Door Upper - left	Inquire
28-5501-T	69-72 Door Upper - left, Taiwan	Inquire
28-5502	69-72 Door Upper - right	Inquire
28-5502-T	69-72 Door Upper - right, Taiwan	Inquire
28-5503	69-72 Cab Upper - left	Inquire
28-5503-T	69-72 Cab Upper - left, Taiwan	Inquire
28-5504	69-72 Cab Upper - right	Inquire
28-5504-T	69-72 Cab Upper - right, Taiwan	Inquire
28-5505-LR	69-72 Bed Upper - short bed, left & right, each	Inquire
28-5505-T	69-72 Bed Upper - short bed, left & right, Taiwan, each	Inquire
28-5506-LR	69-72 Bed Upper - long bed, left & right, each	Inquire
28-5506-T	69-72 Bed Upper - long bed, left & right, Taiwan, each	Inquire
28-5507-LR	69-72 Bed Upper - longhorn, left & right, each	Inquire



28-5482-T



28-5503-T

Part No.		Price
69-72 SIDE MOULDING KITS		
All Taiwan made moulding kits come with stick on hardware in the middle & mechanical hardware at the ends.		
69-70 US made mouldings are secured with all mechanical clips. (nut on, push on & screws)		
71-72 US made mouldings are secured with mechanical & stick on clips. (nut on, push on & screws, stick on)		
Add hardware as required for your year application		
28-5LMB-SK	69-72 Lower Kit - short bed, black, US made	Special Order
28-5LMB-SKT	69-72 Lower Kit - short bed, black, Taiwan made	\$679.95
28-5LMW-SK	69-72 Lower Kit - short bed, wood, US made	Inquire
28-5LMW-SKT	69-72 Lower Kit - short bed, wood, Taiwan made	Inquire
28-5LMB-LK	69-72 Lower Kit - long bed, black, US made	Inquire
28-5LMB-LKT	69-72 Lower Kit - long bed, black, Taiwan made	\$739.95
28-5LMW-LK	69-72 Lower Kit - long bed, wood, US made	Inquire
28-5LMW-LKT	69-72 Lower Kit - long bed, wood, Taiwan made	Inquire
28-5132	69-72 Lower Kit - long bed, black, made in USA - with right side toolbox	Inquire
28-5130	69-72 Lower Kit - long bed, woodgrain, made in USA - with right side toolbox	Inquire
28-5126	69-72 Lower Kit - longhorn, black, made in US - w/o toolbox on right side	Inquire
28-5127	69-72 Lower Kit - longhorn, wood, made in US - w/o toolbox on right side	Inquire
69-72 BLAZER LOWER SIDE MOULDING KITS		
28-5LMB-BL	69-72 Lower Moulding Kit - black, USA made	Special Order
28-5LMB-BL-T	69-72 Lower Moulding Kit - black, Taiwan made	Inquire
28-5LMW-B	69-72 Lower Moulding Kit - wood, USA made	Special Order
28-5LMW-BT	69-72 Lower Moulding Kit - wood, Taiwan made	Inquire
28-5141	69-72 Blazer - w/ 67-68 style mouldings kit, NEW	Inquire
69-72 SUBURBAN LOWER SIDE MOULDING KITS		
28-5SLB-K	69-72 Lower Moulding Kit - black	Inquire
28-5SLW-K	69-72 Lower Moulding Kit - wood	Inquire
69-72 UPPER SIDE MOULDING KITS		
28-5UM-SK	69-72 Upper Moulding Kit - short bed, made in US	Special Order
28-5UM-SKT	69-72 Upper Moulding Kit - short bed, Taiwan made	\$659.95
28-5UM-LK	69-72 Upper Moulding Kit - long bed, made in US	Special Order
28-5UM-LKT	69-72 Upper Moulding Kit - long bed, Taiwan made	\$699.95
28-5104	69-72 Upper Moulding Kit - longhorn, made in USA	Inquire



28-5LMB-SKT



28-5LMB-LKT



28-5UM-SKT

Part No.		Price
TOOLBOX DOOR long & longhorn		
28-5453	69-72 Toolbox Front - USA made, long bed, black	Inquire
28-5353	69-72 Toolbox Front - USA made, long bed, wood	Inquire
28-5453	69-72 Toolbox Front - USA made, longhorn, black	Inquire
28-5351	69-72 Toolbox Front - USA made, longhorn, wood	Inquire
28-5455	69-72 Toolbox Door - USA made, black	Inquire
28-5355	69-72 Toolbox Door - USA made, wood	Inquire
28-5457	69-72 Toolbox Rear - USA made, long & longhorn, black	Inquire
28-5357	69-72 Toolbox Rear - USA made, long & longhorn, wood	Inquire
TAILGATE		
28-5230-K	67-72 Upper Tailgate Moulding Kit - 3pcs	\$79.95
28-5231-T	67-72 Upper Tailgate Left Moulding - each	\$62.95
28-5232-T	67-72 Upper Tailgate Right Moulding - each	\$26.95
28-5230	67-72 Upper Tailgate Handle Moulding - w/ inserts	\$24.95
28-5210	67-72 Upper Tailgate Moulding Clip Kit - per side	\$18.95
28-5233	69-72 Lower Tailgate Moulding - each	\$49.95
28-5233-C	69-72 Lower Tailgate Moulding Kit Clip Kit - 8pcs	\$22.95
TAILGATE BAND		
29-5CHEV	69-72 Tailgate Band - wood appliqué & chrome, w/ hdw - CHEVROLET letters	\$349.95
29-5CHEV-B	69-72 Tailgate Band - black & chrome, w/ hdw - CHEVROLET letters	\$349.95
30-569-TCL	69-72 Tailgate Appliqué Letters - CHEVROLET	\$83.00
29-5GMC	69-72 Tailgate Band - wood appliqué & chrome, w/ hdw - G M C letters	\$349.95
29-5GMC-B	69-72 Tailgate Band - black & chrome, w/ hdw - G M C letters	Inquire
30-569-TGL	69-72 Tailgate Appliqué Letters - G M C	\$89.00
29-5000-SK	67-72 Tailgate Band Screw Kit - w/ correct black finish	\$4.95
29-5GW	69-72 Tailgate Trim Woodgrain Tape - 3" wide	\$32.95

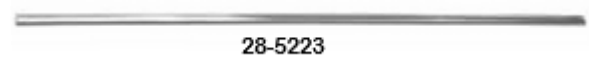

Part No.		Price
MOULDING TAPE		
29-5MW	69-72 Lower Moulding Woodgrain Tape Kit - 24' x 1-11/16" - enough for long and/or short bed	\$56.95
TAILLIGHT MOULDING		
28-53449-L	67-68 Taillight Moulding - left, w/ hdw	\$45.95
28-53449-R	67-68 Taillight Moulding - right, w/ hdw	\$45.95
28-53449-C	67-68 Taillight Moulding Hardware Kit - 4 pcs, per side	\$14.95
28-5448-L	69-72 Taillight Moulding - left	\$33.95
28-5448-R	69-72 Taillight Moulding - right	\$33.95
28-5448-C	69-72 Taillight Moulding Clip Kit - 12 pcs, both sides	\$26.95
CAB PAINT DIVIDER		
28-5809-K	67-72 Cab Moulding Kit - 3 pcs, w/ clips	\$119.95
28-5809	67-72 Cab Rear Moulding - left, w/ nylon clips, US made	\$36.95
28-5810	67-72 Cab Rear Moulding - right, w/ nylon clips, US made	\$36.95
28-5478	67-72 Cab Rear Moulding Jointer - center, US made	\$14.95
28-539-K	67-72 Cab Moulding Retainer Set - nylon clips, 12 pcs	\$7.95
28-0877	67-87 Cab Moulding Clip Screw - #10 x 3/8, 6 pcs - 12 screws required	\$5.45
DRIP RAIL MOULDING		
28-5800	67-72 Drip Rail Moulding Kit - note: mouldings should be fitted before painting	\$189.95
DOOR VENT SHADES		
28-5058	67-72 Door Vent Shades - w/ hdw, pair	\$59.95
29-5303	67-72 Door Edge Guards - pair	\$59.95
BED RAIL KIT		
Reproduction of the original dealer installed accessory bed rail kit. Aluminum rails with woodgrain & cast chrome supports. Able to cut rails to fit short bed trucks.		
28-0119	67-87 Bed Rail Kit - rails, supports, gaskets, hdw	\$799.95
28-0119-SK	67-87 Bed Rail End Support Kit - w/ gasket	\$339.95

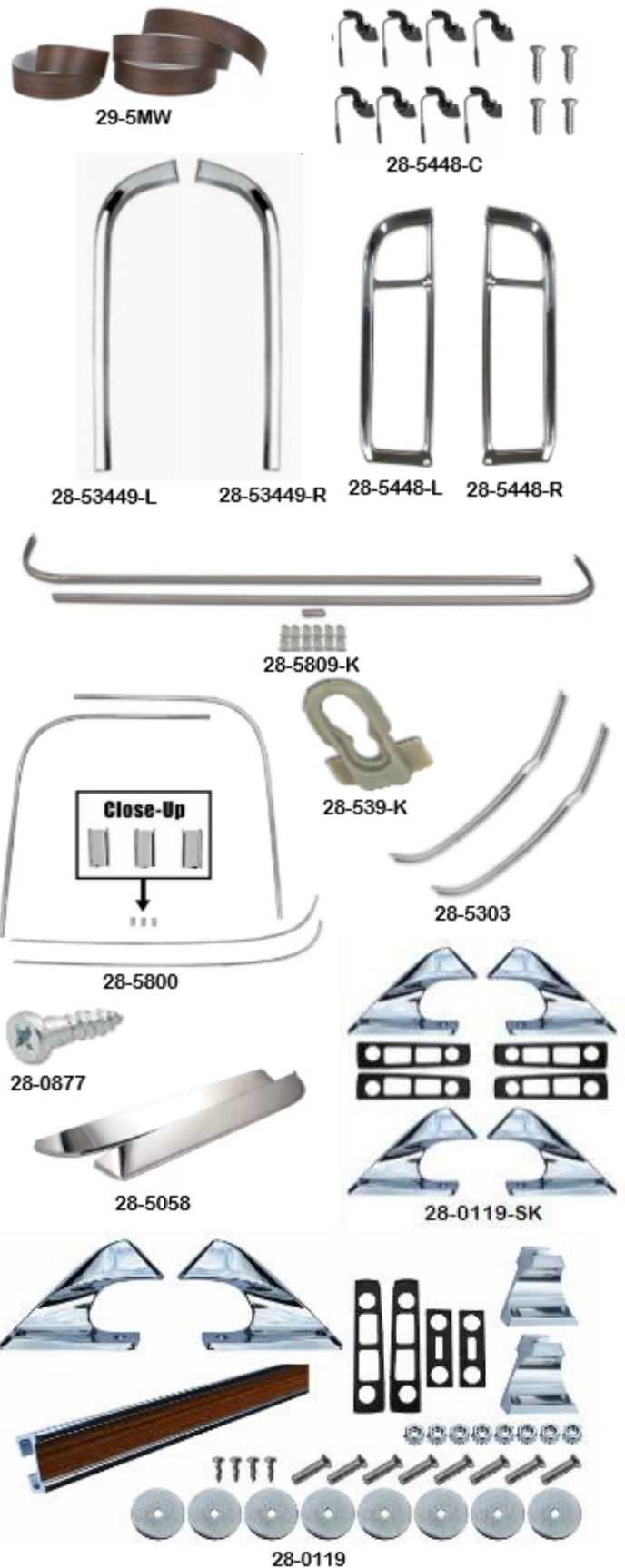

Part No.		Price
SIDE MOULDING CLIP KITS		
	69-70 US made mouldings are secured with all mechanical clips. (nut on, push on & screws)	
	71-72 US made mouldings are secured with mechanical & stick on clips. (nut on, push on & screws, stick on)	
Add hardware as required for your year application		
29-5HK-67	67-68 Body Moulding Clip Kit - short & long bed	\$149.95
29-5LHK-69	69-70 Lower Moulding Clip Kit - short & long bed - with all metal push in or screw on clips	\$179.95
29-5UHK-69	69-70 Upper Moulding Clip Kit - short & long bed - with all metal push in or screw on clips	\$84.95
29-5LHK-71	71-72 Lower Moulding Clip Kit - short & long bed - with center plastic stick on & metal end clips	\$109.95
29-5UBK-71	71-72 Upper Moulding Clip Kit - short & long bed - with center plastic stick on & metal end clips	\$92.95
MOULDING (Clips & Nuts)		
29-Clip-8	67-68 Lower Door Moulding Clip - 2", 10-24 thread	\$2.25
29-Clip-14	67-68 Lower Moulding Clip - 2", nut on type	\$2.50
29-Clip-10	67-68 Lower Moulding Clip - 2 9/16", screw type, w/ nut	\$3.10
29-Clip-16	67-68 Lower Moulding Clip - push in type	\$1.75
29-Screw-1	69-72 Moulding Screw - #8 x 3/4, black finish	\$0.30
29-Clip-1	69-72 Lower Moulding Clip - 4", nut on type	\$3.25
29-Clip-2	69-72 Lower Moulding Clip - 4", push in type	\$4.75
29-Clip-5	69-72 Lower Moulding Clip - 4", adhesive type	\$1.75
29-Clip-3	69-72 Upper Moulding Clip - 1 7/8" wide, screw type, w/ nut	\$3.50
29-Clip-4	69-72 Upper Moulding Clip - 2", push in type	\$2.95
29-Clip-6	69-72 Upper Moulding Clip - adhesive type	\$1.10
29-Clip-7	69-72 Taillight Moulding Clip - push in type, - 3/8" hole, 1 1/4" wide	\$3.70
29-Clip-11	69-72 Upper Tailgate Moulding Clip - push in type - 3/8" hole, 1 1/4" wide, same as Clip-7 w/ extra tension arm	\$2.95
29-Clip-12	Tailgate Outer Moulding End Clip - nut type, up & lower	\$1.95
29-Clip-9	69-72 Upper Fender Moulding Clip - at point	\$2.25
EMBLEM NUTS		
29-Nut-1	Clip Nut - w/ sealer, 10-24 - 1/2" OD	\$0.80
21-0073-2	Emblem Pin Tube Nuts - 3/16" stud & 7/32" hole, pair	\$1.35
29-nut-4	Emblem Pin Speed Nut - 1/4-20 stud, 19/32" OD	\$0.80



29-5HK-67

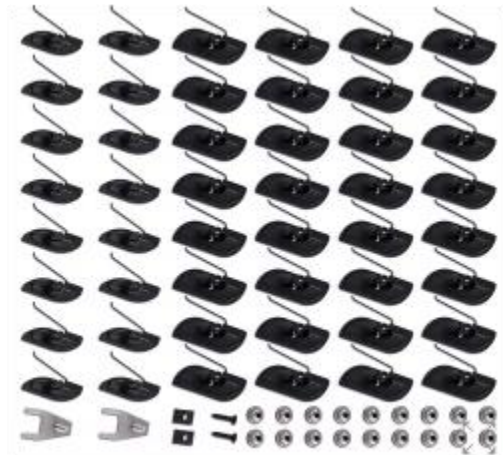

29-5UHK-69



29-5LHK-71



Part No.		Price
CHEV FENDER EMBLEMS		
30-567-10	67-68 Fender Emblems - 10, w/ bowtie, pair	\$79.95
30-567-20	67-68 Fender Emblems - 20, w/ bowtie, pair	Inquire
30-569-C/10	69-70 Fender Emblems - C/10, pair	\$89.95
30-569-CST/10	69-70 Fender Emblems - CST/10, pair	\$99.95
30-569-C10	69-72 Fender Emblems - Custom/10, pair	\$109.95
30-569-C20	69-72 Fender Emblems - Custom/20, pair	\$109.95
30-571-C10	71-72 Fender Emblems - Cheyenne 10, pair	\$104.95
30-571-C20	71-72 Fender Emblems - Cheyenne 20, pair	\$104.95
30-571-C30	71-72 Fender Emblems - Cheyenne 30, pair	\$104.95
CHEV & GMC FENDER EMBLEMS		
30-569-350	69-72 Fender Emblems- 8 350, pair	\$72.95
30-569-396	69-72 Fender Emblems - 8 396, pair	\$79.95
30-569-400	69-72 Fender Emblems - 8 400, pair	\$79.95
30-569-454	69-72 Fender Emblems - 8 454, pair	\$79.95
30-569-502	67-72 Fender Emblems - 8 502, pair	Inquire
30-568-4x4	68-72 Fender Emblems - 4 Wheel Drive, pair	\$99.95
30-571-DLX	71-72 Fender Emblems - Deluxe, pair	\$72.95
30-571-SUP	71-72 Fender Emblems - Super, pair	\$72.95
BLAZER FENDER EMBLEMS		
30-569-BLZ-B	69-72 Fender Emblems - K/5 BLAZER, pair	\$129.95
CHEV DOOR EMBLEMS		
30-567-CUS	67-68 Door Emblems - CUSTOM, pair	\$84.95
30-568-CST	68-68 Door Emblems - CST, pickup, pair <i>-also fits 69-72 Blazer CST</i>	\$89.95
30-567-S	67-72 Tailgate & Door Emblem - rear, CHEVROLET <i>- for suburban & panel</i>	\$74.95
CHEV HOOD & GRILLE		
30-567-H	67-68 Hood Emblem Letters - CHEVROLET	\$79.95
30-567-G	67-68 Grille Emblem - chrome, w/ red details	\$79.95
30-569-H	69-70 Hood Emblem - chrome, w/ blue insert	\$89.95
30-571-CG	71-72 Grille Emblem - chrome, w/ blue insert	\$109.95
20-0344	67-87 Cowl Induction Emblem - 4pc set	\$54.95

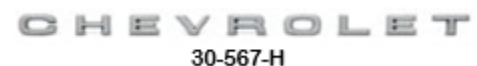

Part No.		Price
CHEV BOXSIDE EMBLEM		
30-569-LH	69-72 Bed Side Emblem - rear 1/4, LONGHORN, pair	\$169.95
CHEV GLOVEBOX EMBLEM		
30-567-C	67-68 Glove Box Door Emblem - Chevrolet, w/ bowtie	\$44.95
30-569-CC	69-72 Glove Box Door Emblem - Chevrolet Custom	\$44.95
30-569-CST	69-70 Glove Box Emblem - Chevrolet CST - also fits 69-72 blazer CST	\$44.95
30-571-S	71-71 Glove Box Door Emblem - CHEYENNE SUPER	\$116.95
30-572-S	72-72 Glove Box Door Emblem - CHEYENNE SUPER - with scroll around super	\$109.95
GMC FENDER EMBLEMS		
30-567-CS	67-67 Fender Emblems - CAMPER SPECIAL, pair	Inquire
30-568-G15V8	68-72 Fender Emblems - GMC 1500 V-EIGHT, pair	\$129.95
30-568-G25V8	68-72 Fender Emblems - GMC 2500 V-EIGHT, pair	\$119.95
30-571-G15C	71-72 Fender Emblems - GMC 1500 CUSTOM, pair	\$89.95
30-571-G25C	71-72 Fender Emblems - GMC 2500 CUSTOM, pair	\$89.95
30-571-G15SC	71-72 Fender Emblems - GMC 1500 SUPER CUSTOM, pair	\$119.95
30-571-G25SC	71-72 Fender Emblems - GMC 2500 SUPER CUSTOM, pair	\$119.95
30-571-G15S	71-72 Fender Emblems - GMC 1500 SIERRA, pair	\$119.95
30-571-G25S	71-72 Fender Emblems - GMC 2500 SIERRA, pair	\$119.95
30-571-G15SG	71-72 Fender Emblems - GMC 1500 SIERRA GRANDE, pair	\$119.95
30-571-G25SG	71-72 Fender Emblems - GMC 2500 SIERRA GRANDE, pair	\$119.95
30-571-GJ	71-72 Fender Emblems - GMC JIMMY, pair	\$119.95
GMC HOOD EMBLEM LETTERS		
30-568-GMC	68-72 Hood Emblem - G M C - will require re-drilling "G" holes on a 67-68 hood	\$99.95
GMC BOXSIDE EMBLEMS		
30-569-SG	69-72 Bed Side Emblem - SIERRA GRANDE, each	\$149.95
30-568-S	69-72 Bed Side Emblem - SIERRA, each	\$114.95
GMC GLOVE BOX EMBLEM		
30-569-GC	69-72 Glove Box Door Emblem - GMC CUSTOM	\$44.95



Part No.		Price
UNIVERSAL TRIM RINGS		
24-007-15S	15" Smooth Trim Ring - stainless, each	\$44.95
24-007-15R	15" Ribbed Trim Ring - stainless, each	\$48.95
24-007-16S	16" Smooth Trim Ring - stainless, each	\$44.95
24-007-16R	16" Ribbed Trim Ring - stainless, each	\$48.95
31-0413	67-87 Rally Wheel Trim Ring - 15" x 3, each	\$59.95
RALLY CAPS		
31-0520	71-87 Rally Wheel Cap - 5 stud, Chev logo & hdw, each	\$41.95
31-0774	71-87 Rally Wheel Cap - 5 stud, GMC logo & hdw, each	\$44.95
31-0521-4X4	71-87 Rally Wheel Cap - 6 stud, 4x4 logo & hdw, each	\$39.95
31-0522	71-87 Rally Wheel Cap - 6 stud, 4x4 open end, each	\$44.95
RALLY CAP INSERTS		
31-0520-CI	71-87 Rally Cap Insert - 5 stud, Chev, 2 1/2", pair	\$32.95
31-0774-GI	71-87 Rally Cap Insert - 5 stud, GMC, 2 1/2", pair	\$29.95
31-0521-4X4I	71-87 Rally Cap Insert - 6 stud, 4x4, 3 1/2", pair	\$9.95
RALLY CAP DECALS		
31-0520-CD	71-87 Rally Cap Decal - 5 stud, Chev, 2 1/2", pair	\$10.95
31-0774-GD	71-87 Rally Cap Decal - 5 stud, GMC, 2 1/2" pair	\$10.95
31-0521-CD	71-87 Rally Cap Decal - 6 stud, Chev logo, pair	\$10.00
31-0521-CDB	71-87 Rally Cap Decal - 6 stud, Blue Chev, pair	\$10.00
31-0521-GD	71-87 Rally Cap Decal - 6 stud, GMC logo, pair	\$10.95
31-0521-4X4D	71-87 Rally Cap Decal - 6 stud, 4x4 logo, pair	\$10.95
RALLY CAP BOLTS		
31-0520-B	71-87 Rally Cap Bolts - zinc plated, OE style, set of 3	\$3.95
WHEEL NUT		
31-0854	Wheel Nut - 1/2 x 20, w/ stainless cap (OE GM), each	\$3.95
38-0230-N	36-70 Wheel Nut - 1/4 - 20, each	\$4.25
31-0070	36-70 Wheel Nut - 7/16 x 20, w/ stainless cap	\$5.95



24-007-15S



24-007-15R



31-0413



31-0520



31-0774



31-0521-4x4



31-0520-CI



31-0774-GI



31-0521-4x4



31-0521-4X4I



31-0520-B

Part No.		Price
ALTERNATOR BRACKET		
36-5337	69-72 Alternator Bracket - OE cast, w/ adjust bracket - small block, V8, cylinder head must have holes in end	\$129.95
36-5338	67-72 Alternator Support - big block, left side, - with short neck water pump	\$99.95
ALTERNATOR CONVERSION KIT		
Converts 1963 - 1974 external volt regulator to newer SI internal volt regulated alternator		
19-0555	Alternator Voltage Regulator Convertor Kit	\$34.95
19-0055	Alternator - 12V, 55 amp, requires 1 wire hook up	\$179.95
19-0455-63	63-72 Alternator Plug - stub harness	\$3.95
19-0455	73-86 Alternator Plug - w/ stub harness, external volt regulator - for alternators with external voltage regulators	\$3.95
36-0530	63-76 Alternator Belt - V8	\$34.95
STARTER		
41-025-12S	Starter - V8, w/ key start solenoid - inquire w/ end housing style of application	\$349.95
41-0300	55-75 Starter Solenoid - w/ ignition terminal, w/ key start	\$59.95
41-0576	Starter Bolts - 3pcs, 1 7/8", 3 5/8" & 4 5/8" long, 3/8-16 thread	\$11.95



Part No.		Price
	EXHAUST MANIFOLD	
41-0381	64-72 Exhaust Manifold - 2 & 3 hole pipe flange, outlet angle back - 6cyl, 230, 250, 292, does not have heat riser	Inquire
36-5350-L	69-72 Exhaust Manifold - left, angle rear dump - 8cyl, C10 & 20, 2 wheel drive	\$229.95
36-5350-R	69-72 Exhaust Manifold - right, angle rear dump - 8cyl, C10 & 20, 2 wheel drive	\$229.95
36-0501	69-72 Exhaust Manifold - 4x4, K10/20, fits L or R on any SB	Inquire
36-0159	Exhaust Manifold - big block, left side	Inquire
36-0244	Exhaust Manifold - big block, right side	Inquire
41-0015	62-87 Valve Cover Hold Down Tabs - set, SB, V8	\$19.95
	EXHAUST HANGER	
41-0103	Universal Exhaust Hanger	\$17.50
	HEAT RISER	
36-0885	64-74 Heat Riser - w/ 2" pipe, 2 3/4 " between studs	\$84.95
41-0206	47-63 Heat Riser Spring - 6cyl	\$32.95
36-0350-G	55-85 Heat Riser Gasket - SB, V8	\$3.95



Part No.		Price
ENGINE GASKETS		
38-0786	63-89 Exhaust Manifold Gasket Set - 6cyl, 194,230,250,292 - has steel insulator on both sides for better burn away & leakage	\$28.95
38-0131	63-89 Valve Cover Gasket - 292 engine - also fits 63-69 230 engine, 66-78 250 engine	\$28.50
38-0126	63-87 Oil Pan Gasket Set - 230, 250, 292 (24 bolt oil pan)	\$29.95
31-0228	63-87 Side Cover Gasket - 230, 250	\$28.95
38-0013	59-87 Rear Main Seal - 250 & SB V8	\$36.95
38-0198	62-89 Front Timing Cover Gasket Set - 230, 250, 292	\$37.95
41-0919	55-87 Harmonic Balancer Seal Repair Kit - 6 & 8cyl	\$29.95
IGNITION POINTS & COIL		
41-0PC	57-74 Ignition Points & Condenser - V8, uniset type	\$19.95
41-03PC	63-72 Ignition Points & Condenser - 6cyl	\$42.95
41-0774	57-74 Distributor Wire Grommet - V8 only	\$3.50
41-02IC-12	Ignition Coil - 12V	\$42.95
SPARK PLUG WIRE & RETAINERS		
36-0002	60-72 Spark Plug Wire Separator - 2 wire, pair	\$8.50
36-0004	60-72 Spark Plug Wire Separator - 4 wire, pair	\$8.50
36-0005	60-72 Spark Plug Wire Separator - 4 wire, no stand, BB, pair	\$5.95
36-0083	57-72 Spark Plug Shields - small block, V8, set of 4	\$34.95

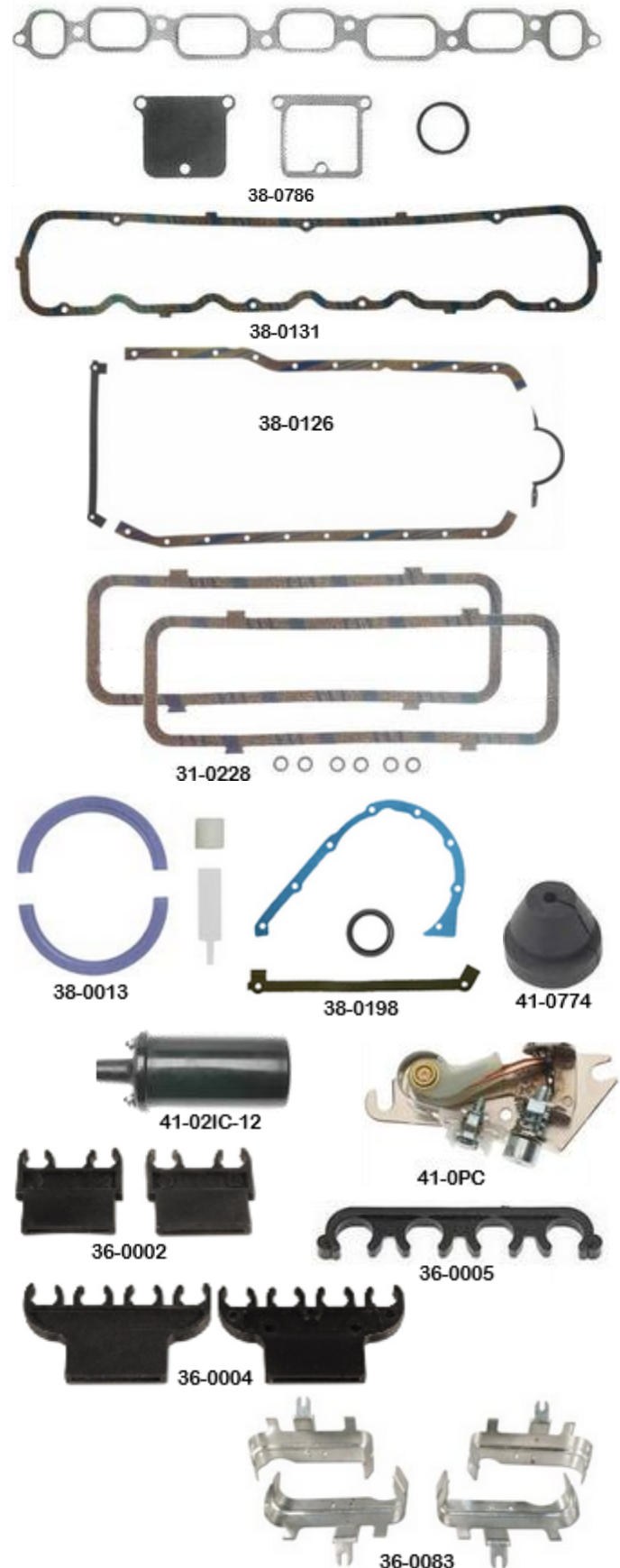

Part No.		Price
SPARK PLUG WIRE & RETAINER (cont.)		
36-0703	58-72 Spark Plug Wire Retainer - side, w/ small block	\$3.95
36-0704	58-69 Spark Plug Wire Retainer - 4 wire, rear small block, L & R	\$8.95
36-0795	58-72 Spark Plug Wire Clip - at oil pan, V8, each	\$9.95
41-02PW-6	47-77 Spark Plug Wire Set - 6cyl, 7mm, silicone wire	\$42.95
36-5721	72-72 Spark Plug Wire Set - OE, date coded style, all big block	\$129.95
36-0421	V8 Spark Plug Wire Set - when converting to HEI distributor - extra long, 90 degree ends, cut to fit, special order	Special Order
IGNITOR KIT		
41-0162-A	63-76 Ignitor Kit - 6 cyl, w/ vac advance - Hall Effect trigger, no moving parts, improves starting and MPG	\$169.95
TRANSMISSION LINE RETAINER		
41-0090	60-72 Transmission Line Retainer Clips - pair	\$2.95
TAILSTOCK SEAL		
41-0054	55-72 Rear Tailstock Seal w/ Bushing - 3spd std transmission	\$42.95
41-0041	55-72 Rear Tailstock Seal - 3spd std transmission	\$6.65
TRANSMISSION GASKET SET		
41-5301	67-72 Trans Gasket Set - 3spd, Saginaw	\$29.95
DRIVESHAFT U-JOINT		
41-0369	55-87 Driveshaft U-joint - w/ 3spd or automatic, 1/2 ton, each	\$39.95
41-0331	67-72 Driveshaft U-joint - w/ 4spd, 1/2 & 3/4 ton - 3 5/8" dia, w/ 1 3/16" cup	\$36.95
41-0021	U-joint Retainer - 1 3/8" center to center, each	\$10.95
41-0022	U-joint Retainer - 1 1/2", center to center, each	\$12.95
41-0023	U-joint Retainer - 1 3/4" center to center, metric, each	\$11.95



Part No.		Price
CHOKE KIT		
36-0086	Vacuum choke break - 4bl, w/ QJ carb	\$44.95
36-5412	67-69 Choke Kit - small block, w/ QJ carb - stamped support with straight rod	\$49.95
36-5413	69-72 Choke Kit - w/ 327, 350, w/ 4bl, QJ carb - stamped support and bent rod	\$49.95
36-5411	70-72 Choke Kit - w/ 402, big block w/ 4bl, QJ carb - pot metal support & bent rod	\$56.95
CLUTCH RELEASE BEARING		
41-0086	38-75 Clutch Release Bearing - 6cyl & most V8, 1 7/8" long	\$79.95
41-0087	47-84 Clutch Release Bearing - 1 1/4" long	\$64.95
41-0440	47-87 Pilot Bushing - brass, 6 & 8cyl	\$19.95
CLUTCH KIT		
41-0221	63-76 Clutch Kit - 10 1/2" clutch, w/ 3 speed transmission, NEW - with pressure plate, release bearing, pilot bushing	\$345.00
41-0232	62-78 Clutch Kit - 12" clutch, NEW - with pressure plate, release bearing, pilot bushing	\$265.95
41-0049	Clutch - 11", 10 spline, 1.125 diameter, 1 1/4" tall release bearing - diaphragm style	\$249.95
CLUTCH & BRAKE PEDAL ARM		
7-550-C	67-72 Clutch Pedal Arm	Inquire
7-550-CS	67-72 Clutch Pedal Spring - under dash cross shaft	\$6.95
7-551-S	67-72 Brake Pedal Return Spring	\$5.95
7-0413	60-72 Clutch Pedal Cross Shaft Bushing - nylon, 2 required, each - approx 3/4" dia	\$6.50
7-0550-B	60-72 Brake Pedal Cross Shaft Bushing - nylon, 2 required, each - approx 1" dia	\$8.50
CLUTCH FORK		
36-0470-F	63-72 Clutch Fork	Inquire
36-0470-RS	63-72 Clutch Fork Return Spring	\$10.95
36-0470	60-72 Clutch Push Rod Wedge - at fork	\$11.95
36-0470-P	60-72 Clutch Adjust Rod Pivot - 3/8 NC, each	\$29.95
36-0470-PF	60-72 Clutch Rod Pivot Swivel - 3/8 NF, each	\$29.95



Part No.		Price
CLUTCH BALL STUD		
36-0123	63-72 Clutch Ball Stud - on frame bracket, w/ washer & nut	\$18.95
36-0123-K	63-72 Clutch Ball Stud Keeper - on frame bracket	\$4.95
36-0124	63-72 Clutch Ball Stud - engine side, 6 & 8cy, K10/20	\$21.95
41-0900	63-81 Clutch Ball Stud - 13/16-16 thread x 1 1/2" long, OE	\$19.95
41-0217	38-72 Clutch Fork Stud Spring	\$14.95
CLUTCH Z-BAR		
36-5126-V	67-72 Clutch Z-bar - engine bracket, V8	\$34.95
36-5125-1	67-72 Clutch Z-bar - w/ V8, 3 speed std, 2x2	\$79.95
36-5125-2	67-72 Clutch Z-bar - w/ 6cy, 3 speed std, 2x2	Inquire
36-5125-3	67-72 Clutch Z-bar - w/ 4x4	Inquire
36-5125-S	67-72 Clutch Z-bar Support - at frame	\$49.95
36-511-R	67-72 Clutch Rod - w/ swivel, pedal to Z-bar, 3/8 NF, 10" long - V8, 2WD	\$36.95
36-0125-S	63-72 Clutch Z-bar Seals - pair	\$6.00
36-0125-B	63-72 Clutch Z-bar Bushings - nylon, pair	\$8.00
36-0125-C	63-72 Clutch Z-bar Retainer Clip - each	\$2.00
36-0125-G	Grease Fitting - 1/8 straight	\$1.00
36-0470-C	Shift & Clutch Linkage Clip - each	\$2.50
FLYWHEEL COVER		
36-0908	55-72 Flywheel Inspection Cover - 3 & 4 speed trans	\$44.95
41-0477	55-72 Flywheel Cover - lower, V8	\$87.95
36-0810	63-72 Flywheel Cover - w/ 400 trans	\$59.95
41-0089	63-72 Flywheel Cover - w/ power glide trans, 6 & 8cyl, plastic	\$89.95
41-0471	69-72 Flywheel cover - will fit all 350 auto trans. 6 & 8cyl, plastic	\$89.95
VAPOR CANNISTER		
34-0550-C	Charcoal Canister	Inquire
34-0500-F	Charcoal Canister Filter - each	\$8.95



Part No.		Price
ASSEMBLY MANUAL		
42-5FAM	67-72 Assembly Manual	\$56.95

SHOP MANUAL

Fully illustrated with complete information on the repair of your truck. Includes data specifications, capacities, wiring, etc. Printed for Chev but also pertains to GMC.

42-5SM-67	67-67 Shop Manual	\$44.95
42-5SM-68	68-68 Shop Manual	\$44.95
42-5SM-69	69-69 Shop Manual	\$44.95
42-5SM-70	70-70 Shop Manual	\$44.95
42-5SM-71	71-71 Shop Manual	\$44.95
42-5SM-72	72-72 Shop Manual	\$44.95

WIRING DIAGRAM

42-567WD	67-67 Wiring Diagram	\$9.95
42-568WD	68-68 Wiring Diagram	\$9.95
42-569WD	69-69 Wiring Diagram	\$9.95
42-570WD	70-70 Wiring Diagram	\$9.95
42-571WD	71-71 Wiring Diagram	\$9.95
42-572WD	72-72 Wiring Diagram	\$9.95

CHEV OWNERS MANUAL

42-567C	67-67 Owners Manual - Chev, w/ bag	\$22.95
42-568C	68-68 Owners Manual - Chev, w/ bag	\$22.95
42-569C	69-69 Owners Manual - Chev, w/ bag	\$22.95
42-570C	70-70 Owners Manual - Chev, w/ bag	\$22.95
42-571C	71-71 Owners Manual - Chev, w/ bag	\$22.95
42-572C	72-72 Owners Manual - Chev, w/ bag	\$22.95

DECALS

14-5660-D	67-72 Jack Instructions Decal	\$4.95
-----------	-------------------------------	--------



42-5FAM

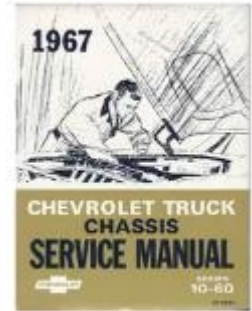

42-5SM-67



42-567WD



42-567C

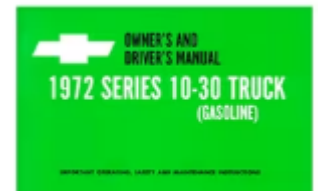

42-572C

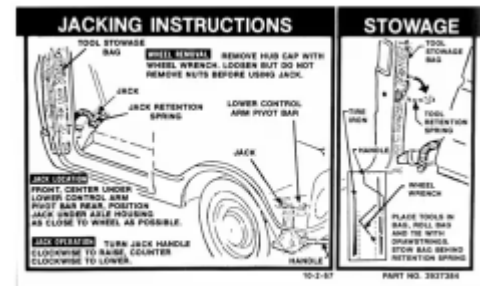

14-5660-D

Part No.		Price
FENDER BOLTS		
49-0610	5/16"-18 x 7/8" w/ 11/16" floating washer, NC, each	\$1.65
49-0612	5/16"-18 x 1" w/ 7/8 floating washer, NC, each	\$2.10
49-0613	5/16"-18 x 3/4" w/ washer head, NC, each	\$1.65
49-0614	3/8"-16 x 1" w/ 1" floating washer, NC, each	\$1.80
49-0615	3/8"-16 x 1 1/2" w/ 1 1/8 floating washer, NC, each	\$2.10
49-0620	5/16"-18 x 3/4" w/ OE style washer head, each	\$0.95
49-0621	5/16"-18 x 1 1/16" dog point, w/ floating washer, each	\$1.75

U-NUT		
49-0710	U-nut - 5/16"-18, each	\$1.50

LOCK WASHER		
49-0124	1/2" External Tooth Lock Washer - flywheel bolts, each	\$0.30

BODY ALIGNMENT SHIMS (galvanized steel)		
20-000D	1/16" w/ 3/8 slot shim, each	\$1.25
20-000E	1/8" w/ 3/8 slot shim, each	\$1.25
20-000K	Shim Kit - 4 x 1/16" and 4 x 1/8", set of 8	\$9.95

TOTALLY STAINLESS BOLT KIT		
Includes sperate kits for front bumper, door hinges, door latch & catch, fender to firewall brace rods, front & inner fenders, grill & gravel pan, headlight & parking lens, hood hinges, hood latch, catch & braces, interior, outside mirrors, radiator support,, regulators & relay.		
49-5390	67-72 Chev Body Bolt Kit - 18-8 stainless steel, OE style - indented hex & Phillips drive, cab forward, does not include any bed hardware	\$369.95

COOLER		
U-1100-CRD	Vintage Chevrolet Picnic Cooler - "GENUINE Chevrolet" - red cooler, blue bowtie, white script, 11-1/2" x 9" x 12-1/4"	\$189.95

